

VKP (Open – Sealed)



**Features**

- Limiting continuous current 32 A at 85°C
- Wide voltage range

**Typical Applications**

- ABS control
- Blower fans
- Car alarm
- Cooling fan
- Engine control
- Fuel pump
- Hazard warning signal
- Heated front screen
- Heated rear screen
- Ignition
- Lamps front, rear, fog light
- Interior lights
- Main switch/supply relay
- Seat control
- Seatbelt pretensioner
- Sun roof
- Turn signal
- Valves
- Window lifter
- Wiper control

Please contact Tyco Electronics for relay application support.



VKP\_3d01

**Design**

- ELV compliant
- Open: flux tight type
- Sealed: washable type

**Weight**

- Approx. 19 g (0.67 oz.) open version
- Approx. 22 g (0.77 oz.) sealed version

**Nominal Voltage**

12 V or 24 V

**Terminals**

PCB terminals, for assembly on printed circuit boards

**Conditions**

All parametric, environmental and endurance tests are performed according to EIA Standard RS-407-A at standard test conditions unless otherwise noted:  
23°C ambient temperature,  
20 - 50% RH, 998.9 ±33.9 hPa.

For general storage and processing recommendations please refer to our Application Notes and especially to *Storage* in the "Glossary" page 23 or at <http://relays.tycoelectronics.com/appnotes/>

**Disclaimer**

All technical performance data apply to the relay as such, specific conditions of the individual application are not considered. Please always check the suitability of the relay for your intended purpose. We do not assume any responsibility or liability for not complying herewith. We recommend to complete our questionnaire and to request our technical service. Any responsibility for the application of the product remains with the customer only. All specifications are subject to change without notification. All rights of Tyco Electronics are reserved.

VKP (Open – Sealed)

**Dimensional Drawing**

**VKP Open Version**

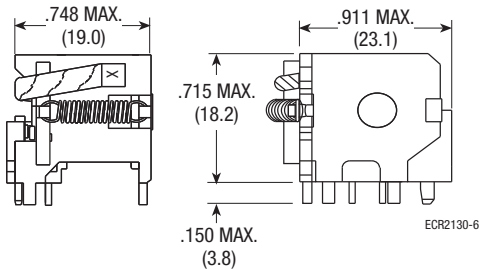

**Dimensional Drawing**

**VKP Sealed Version**

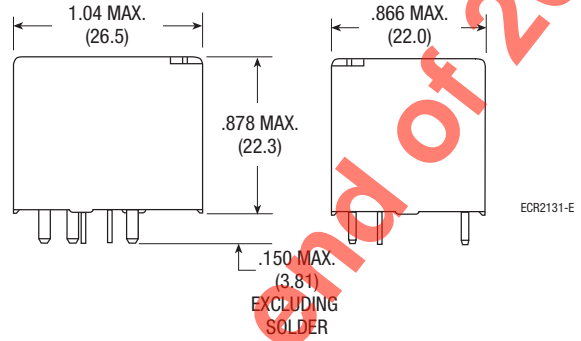

**Mounting Hole Layout (bottom view)**

**Open version**

**Hole Size**

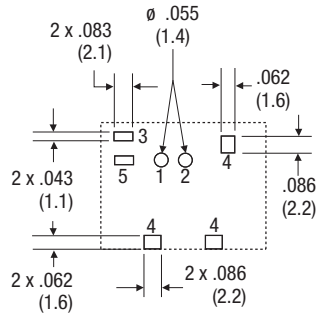

**Center-To-Center**

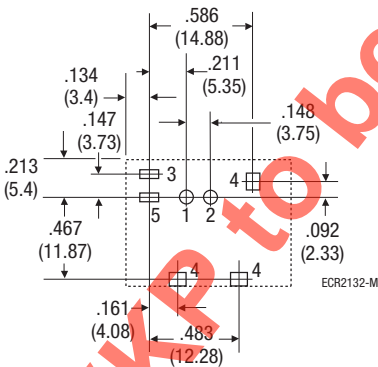

**Sealed Version**

**Hole Size**

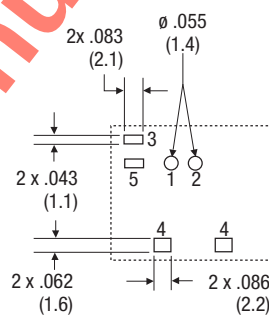

**Center-To-Center**

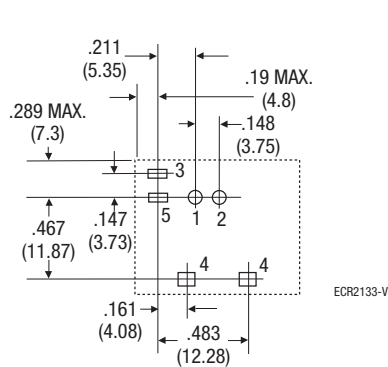

VKP to be discontinued by end of 2009

VKP (Open – Sealed)

**Contact Data**

Typical areas of application	Resistive/inductive loads		High inrush, lamp and capacitive loads	
	1 Make contact/ 1 Form A	1 Changeover contact/ 1 Form C	1 Make contact/ 1 Form A	1 Changeover contact/ 1 Form C
Contact configuration				
Circuit symbol (see also Pin assignment)				
Rated voltage	12 V			
Rated current	32 A	NC/NO 25/32 A	32 A	NC/NO 25/32 A
Limiting continuous current				
23°C	40 A	30/40 A	40 A	30/40 A
85°C	32 A	25/32 A	32 A	25/32 A
105°C	25 A	15/25 A	25 A	15/25 A
Contact material	AgNi0.15 (VKP-***42)		AgSnO <sub>2</sub> (VKP-***52)	
Max. switching voltage/power	See load limit curve			
Max. switching current		NC/NO		NC/NO
On <sup>1)</sup>	100 A	30 A/100 A	180 A	30 A/180 A
Off <sup>2)</sup>	60 A	30 A/60 A	60 A	30 A/60 A
Min. recommended current	1 A at 5 V			
Voltage drop at 10 A (initial)	Typ. 15 mV	Typ. 20/15 mV	Typ. 20 mV	Typ. 25/20 mV
Mechanical endurance (without load)	> 10 <sup>7</sup> operations			
Electrical endurance (example of resistive load)	10 <sup>5</sup> operations at 40 A, 14 V, on NO contact			

<sup>1)</sup> Inrush current for lamp load.  
<sup>2)</sup> See load limit curve.

**Load Limit Curve**

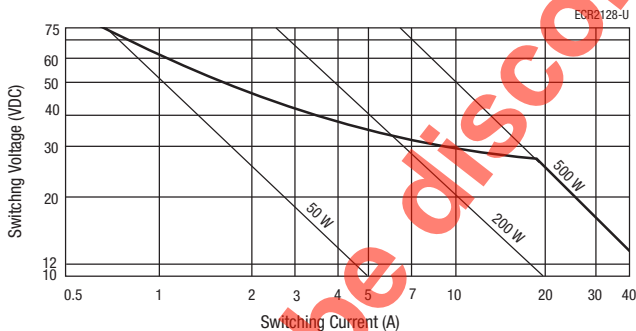

Safe breaking, arc extinguished (normally open contact) for resistive loads.

**Circuit Diagram**

1 Make contact/1 Form A

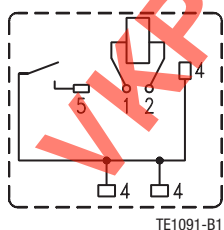

1 Changeover contact/1 Form C

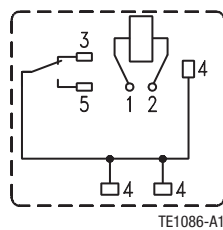

VKP (Open – Sealed)

**Contact Data**

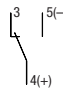
Typical areas of application	Flashing lamps	
	1 Make contact/ 1 Form A	1 Changeover contact/ 1 Form C
Contact configuration		
Circuit symbol (see also Pin assignment)		
Rated voltage	12 V	
Rated current	30 A	20/30 A
Limiting continuous current		
23°C	35 A	25/35 A
85°C	30 A	20/30 A
105°C	25 A	15/25 A
Contact material	AgSnO <sub>2</sub> (VKP-***72) <sup>1)</sup>	
Max. switching voltage/power	See load limit curve on previous page	
Max. switching current	High current version	High current version
On <sup>2)</sup>	240 A	NC/NO 60/240 A
Off	30 A	20/30 A
Steady-state flashing <sup>3)</sup>		NC/NO
Open	30 A	10/30 A
Sealed	25 A	10/25 A
Alternate flashing <sup>4)</sup>		NC/NO
Open		8/8 A
Sealed		8/8 A
Min. recommended load <sup>5)</sup>	1 A at 5 V	
Voltage drop (initial) at 10 A	100 mV max. for NO contacts, 200 mV max. for NC contacts, typ. 40 mV	
Mechanical endurance (without load)	Typ. 10 <sup>7</sup> operations	
Electrical endurance	See application information below	

<sup>1)</sup> Center contact pin 4 to be connected to positive potential.

<sup>2)</sup> Inrush current for lamp load.

<sup>3)</sup> Continuous On-Off cycling of a single set of lamps at 60 to 90 operations per minute and approx. a 50% duty cycle.

<sup>4)</sup> Continuous cycling between two sets of lamps with one set switched by the NO contacts and the other by the NC contacts, at 60 to 90 operations per minute and approx. a 50% duty cycle.

<sup>5)</sup> See chapter Diagnostics of Relays in our Application Notes page 31 or consult the internet at <http://relays.tycoelectronics.com/appnotes/>

**Coil Data**

Available for nominal voltages	12 V / 24 V
Nominal power consumption of the unsuppressed coil at nominal voltage	1.6 W
Test voltage winding/contact	500 VAC <sub>rms</sub>
Maximum ambient temperature range	-40 to +125°C
Operate time at nominal voltage	Typ. 5 ms
Release time at nominal voltage <sup>1)</sup>	Typ. 3 ms

<sup>1)</sup> For unsuppressed relay coil.

**Note:**

A low resistive suppression device in parallel to the relay coil increases the release time and reduces the lifetime caused by increased erosion and/or higher risk of contact tack welding.

## VKP (Open – Sealed)

### Application Information

**Load Polarity:** VKP series relays for flashing lamp applications are constructed with special AgSnO movable contacts and standard AgSnO stationary contacts. This causes the relay to be sensitive to the polarity of the load voltage. This type of VKP relay must be mechanized in the circuit such that the more positive connection is made to the movable contact (identified as terminal 4 in the wiring diagrams). Failure to do so will nullify the benefit of the special AgSnO contact material and will result in significantly reduced relay life.

**Typical Applications:** Typical applications: VKP series relays for flashing lamp applications are typically used for turn signals, hazard warning, emergency vehicle, and security system applications. They may also be suitable for high in-rush current capacitive loads such as audio amplifiers. Use on inductive loads or loads with high continuous load currents should be avoided. The relay should also not be used in applications, which do not have a significant make current, as high contact voltage drop may result.

**Note:** The VKP-\*\*\*72 series relay with special AgSnO contact material replaces the VKP-XXX32 standard current and the VKP-\*\*\*62 high current PdCu/AgNiO.15 contact relays.

**High Current Relays:** VKP-\*\*\*72 series relays for flashing lamp applications are generally suitable for passenger car, light truck with or without special trailing requirements, and medium duty truck, and emergency vehicle applications. They are also generally suitable for security system applications for flashing lamps and for most audio amplifier applications. This relay is also recommended for alternating flasher applications, such as emergency vehicles. This version has much improved performance on the normally open contacts, so optimum life can be attained for alternating applications by using two normally open relays and powering the coils alternately.

### Electrical Life Test Information

**High current relays:** 3 bulb T/S system, combined turn signal and hazard warning with special trailing (test requirements):

3 bulb	2.1 million operations
6 bulb	194 K operations
7 bulb	259 K operations
14 bulb	497 K operations
TOTAL	3.0 million operations

This application represents about the limit of the performance capability of the "Flashing Lamp" type VKP relay. It should be noted that the low current operations have very little effect on the product life where as the 14 bulb (only) loads can be expected to fail at less than 1 million operations.

**Note:** Bulb as used here is a 27 Watt turn signal bulb, trade #1156. Testing includes operations at -40°C, 23°C, and 85°C.

**Design Considerations:** It should be noted that although the VKP series relays are capable of handling relatively high currents, when applying the product under high current and high ambient temperature conditions, providing adequate conductor volume is critical, as is the solder connection, particularly with respect to the normally open contact terminal. It may be necessary to use high temperature solder, a plated through hole PCB, or copper lead frame type construction under these conditions to prevent failure of the solder joint.

VKP (Open – Sealed)

**Environmental Conditions**

Temperature range, storage	Refer to <i>Storage</i> in the “Glossary” catalog page 23 or <a href="http://relays.tycoelectronics.com/appnotes/">http://relays.tycoelectronics.com/appnotes/</a>			
Test	Relevant standard	Testing as per	Dimension	Comments
Vibration resistance	1.27 mm double amplitude 5 g constant 0.5 mm double amplitude 10 g constant		10 - 40 Hz 40 - 70 Hz 70 - 100 Hz 100 - 500 Hz	Valid for NC contacts. NO contacts are significantly higher
Shock resistance	Half sine wave pulse		11 ms 20 g	No change in the switching state > 10 μs
Jump start	24 V for 5 minutes conducting nominal current at 23°C			
Drop test	Capable of meeting specifications after 1.0 m (3.28 ft) drop onto concrete in final enclosure			
Flammability	UL94-HB or better, internal parts (meets FMVSS 302)			

Ordering Information

Part Numbers (see table below for coil data)		Contact Arrangement	Contact Material	Enclosure	Applications
Relay Description	Part Number				
VKP-11F42	3-1393277-7	1 Form A	AgNi0.15	Open	General automotive loads
VKP-11H42	5-1419148-4	1 Form A	AgNi0.15	Open	General automotive loads
VKP-15F42	1393278-1	1 Form C	AgNi0.15	Open	General automotive loads
VKP-15H42	5-1393277-5	1 Form C	AgNi0.15	Open	General automotive loads
VKP-15F52	5-1393277-1	1 Form C	AgSnO <sub>2</sub>	Open	High inrush loads
VKP-31F42	1393277-1	1 Form A	AgNi0.15	Sealed	General automotive loads
VKP-31H42	1393277-2	1 Form A	AgNi0.15	Sealed	General automotive loads
VKP-35F42	1393277-3	1 Form C	AgNi0.15	Sealed	General automotive loads
VKP-35H42	7-1393277-9	1 Form C	AgNi0.15	Sealed	General automotive loads
VKP-31F52	6-1393277-2	1 Form A	AgSnO <sub>2</sub>	Sealed	High inrush loads
VKP-31H52	1432198-1	1 Form A	AgSnO <sub>2</sub>	Sealed	High inrush loads
VKP-35F52	7-1393277-3	1 Form C	AgSnO <sub>2</sub>	Sealed	High inrush loads
VKP-35H52	1432197-1	1 Form C	AgSnO <sub>2</sub>	Sealed	High inrush loads
VKP-11F72	1432444-1	1 Form A	Special AgSnO <sub>2</sub>	Open	Flashing lamp loads
VKP-15F72	1432445-1	1 Form C	Special AgSnO <sub>2</sub>	Open	Flashing lamp loads
VKP-31F72	1432413-1	1 Form A	Special AgSnO <sub>2</sub>	Sealed	Flashing lamp loads
VKP-35F72	1432438-1	1 Form C	Special AgSnO <sub>2</sub>	Sealed	Flashing lamp loads

Coil Versions

Coil Data for VKP	Rated Coil Voltage (V)	Coil Resistance ±10% (Ω)	Must Operate Voltage (V)	Must Release Voltage (V)	Allowable Overdrive <sup>1)</sup> Voltage (V)	
					at 23°C	at 85°C
VKP-**F**	12	90	6.8	1.2	19.6	14.3
VKP-**H** <sup>2)</sup>	24	362	13.9	2.4	39.3	28.6

<sup>1)</sup> Allowable overdrive is stated with no load applied and minimum coil resistance.

<sup>2)</sup> On request.

**Standard Delivery Packs** (orders in multiples of delivery pack)

VKP: 525 pieces