

PLEASE CHECK WWW.MOLEX.COM FOR LATEST PART INFORMATION

Part Number: [0432238131](#)
Status: **Active**
Overview: [modular_plugs_jacks](#)
Description: Modular Jack, Right Angle, Low Profile, 8/8, 3 Ports

Documents:

[3D Model](#) [Product Specification PS-43223-001 \(PDF\)](#)
[Drawing \(PDF\)](#) [RoHS Certificate of Compliance \(PDF\)](#)

Agency Certification

CSA LR19980
 UL E107635

General

Product Family Modular Jacks/Plugs
 Series [43223](#)
 Component Type PCB Jack
 Magnetic No
 Overview [modular_plugs_jacks](#)
 Performance Category 3
 Power over Ethernet (PoE) N/A
 Product Name RJ45

Physical

Boot Color N/A
 Color - Resin Black
 Durability (mating cycles max) 500
 Flammability 94V-0
 Inverted / Top Latch No
 Keying to Mating Part None
 Lightpipes/LEDs None
 Material - Metal Phosphor Bronze
 Material - Plating Mating Gold
 Material - Plating Termination Tin
 Material - Resin High Temperature Thermoplastic
 Orientation Right Angle (Side Entry)
 PCB Locator Yes
 PCB Retention Yes
 PCB Thickness Recommended (in) 0.062 In
 PCB Thickness Recommended (mm) 1.57 mm
 Packaging Type Tray
 Panel Mount Without Flange
 Pitch - Mating Interface (in) 0.040 In
 Pitch - Mating Interface (mm) 1.02 mm
 Pitch - Term. Interface (in) 0.050 In
 Pitch - Term. Interface (mm) 1.27 mm
 Plating min: Mating (µin) 50
 Plating min: Mating (µm) 1.25
 Plating min: Termination (µin) 100
 Plating min: Termination (µm) 2.5
 Ports 3
 Positions / Loaded Contacts 8/8
 Surface Mount Compatible (SMC) No
 Temperature Range - Operating -40°C to +85°C
 Termination Interface: Style Through Hole
 Waterproof / Dustproof No

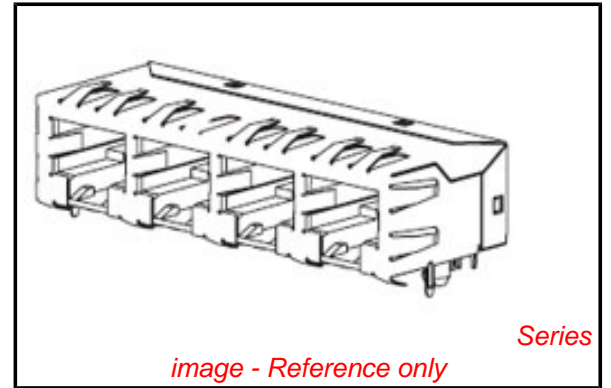

EU RoHS

**ELV and RoHS
 Compliant**
REACH SVHC
 Not Reviewed
**Halogen-Free
 Status**
Not Reviewed

China RoHS



**Need more information on product
 environmental compliance?**

Email productcompliance@molex.com
 For a multiple part number RoHS Certificate of
 Compliance, [click here](#)

Please visit the [Contact Us](#) section for any
 non-product compliance questions.

Search Parts in this Series

[43223Series](#)

Mates With

FCC 68 Plugs

Wire/Cable Type	N/A
Electrical	
Current - Maximum per Contact	1.5A
Grounding to PCB	Yes
Grounding to Panel	None
Shielded	No
Voltage - Maximum	150V AC (RMS)

Solder Process Data

Lead-free Process Capability	Wave Capable (TH only)
------------------------------	------------------------

Material Info

Old Part Number	A432238131
-----------------	------------

Reference - Drawing Numbers

Packaging Specification	PK-43249-004
Product Specification	PS-43223-001
Sales Drawing	SDA-43223
Test Summary	TS-43223-001

This document was generated on 06/07/2010

PLEASE CHECK WWW.MOLEX.COM FOR LATEST PART INFORMATION

NOTES:

- 1) MATERIAL:
HOUSING: GLASS FILLED NYLON, UL94V-0, COLOR: BLACK
INSULATOR: GLASS FILLED NYLON, UL94V-0, COLOR: BLACK
TERMINALS: PHOSPHOR BRONZE: .012/ 0.30 THICK
- 2) FINISH:
TERMINALS:
SELECT GOLD IN CONTACT AREA: 50 MICROINCHES/ 1.27 MICROMETERS MIN.,
*SELECT TIN IN PC TAIL AREA: 100 MICROINCHES/ 2.54 MICROMETERS MIN.,
WITH OVERALL NICKEL UNDERPLATE: 50 MICROINCHES/ 1.27 MICROMETERS MIN.
*THE PRIMARY SHIPPING CARTON WILL BE LABELED "COMPLIANT TO RoHS DIRECTIVE 2002/95/EC AND ELV ANNEX II OF DIRECTIVE 2000/53/EC".
CARTONS WITHOUT THIS LABEL MAY CONTAIN PRODUCT WITH TIN-LEAD IN THE PC TAIL AREA.
- 3) PRODUCT SPECIFICATION AND PROCESSING PARAMETERS: PS-43223-001.
- 4) PACKAGING SPECIFICATION:
UNSHIELDED CONNECTOR ASSEMBLIES PACKAGED IN TRAYS PER MOLEX PACKAGING SPECIFICATION PK-43249-004.
- 5) SEE SHEETS 4-6 FOR P.C. BOARD LAYOUTS.
- 6) SEE SHEET 2 FOR THE SHIELDED JACK ASSEMBLY.
- 7) FOR 6 CIRCUIT JACKS CENTERLINE TO CENTERLINE SPACING IS .448/ 11.38, FOR 8 CIRCUIT JACKS CENTERLINE TO CENTERLINE SPACING IS .550/ 13.97.
- 8) ALL UNTOLERANCED DIMENSIONS ARE SHOWN FOR REFERENCE ONLY.
- 9) THIS PART CONFORMS TO CLASS B REQUIREMENTS OF COSMETIC SPECIFICATION PS-45499-002.

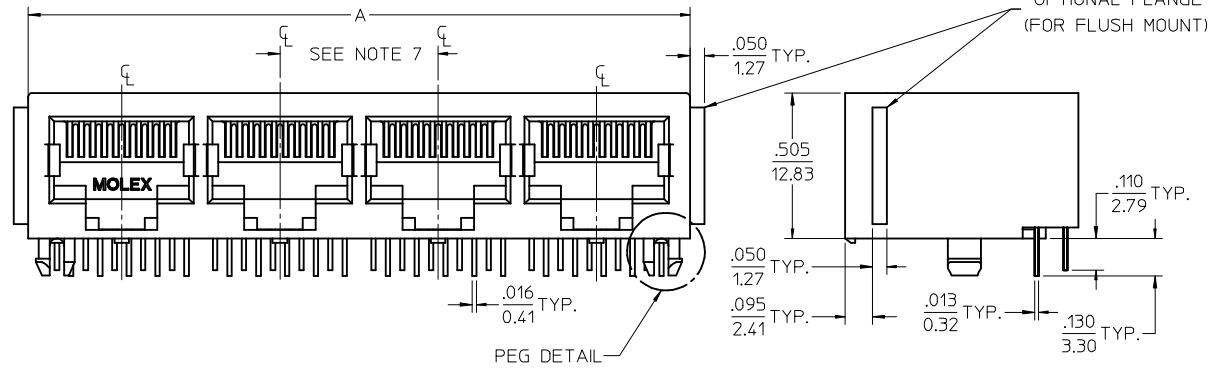

4 PORT 8 LOADED
10 JACK SHOWN

UNSHIELDED GANGED JACK ASSEMBLY
SEE SHEET 3

CENTER PEG
(8 PORT ASSY. ONLY)

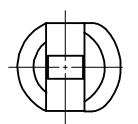
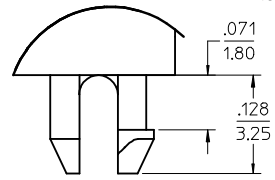

SNAP-FIT PEG DETAIL
SCALE 8:1

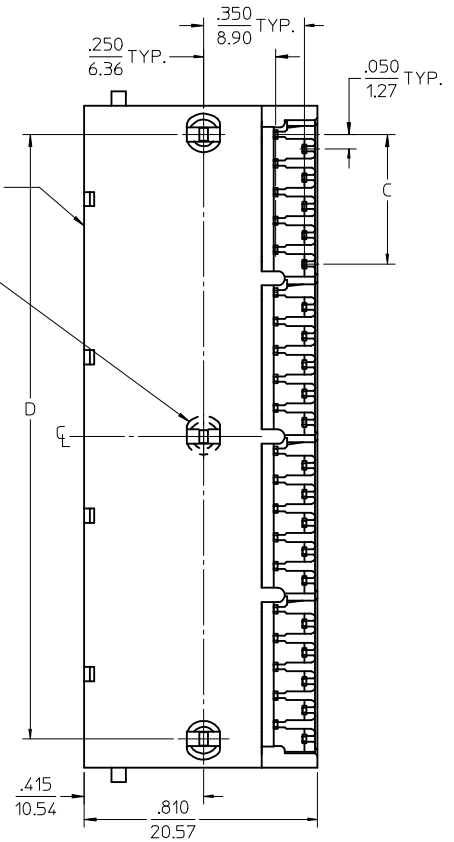

6 CIRCUIT HOUSING

CIRCUIT SIZE	NO. OF PORTS	DIM. A	DIM. C	DIM. D
6	2	.985 (25.02)	.250 (6.35)	.848 (21.54)
4	2	.985 (25.02)	.150 (3.81)	.848 (21.54)
2	2	.985 (25.02)	.050 (1.27)	.848 (21.54)
6	3	1.433 (36.40)	.250 (6.35)	1.296 (32.92)
4	3	1.433 (36.40)	.150 (3.81)	1.296 (32.92)
2	3	1.433 (36.40)	.050 (1.27)	1.296 (32.92)
6	4	1.881 (47.78)	.250 (6.35)	1.744 (44.30)
4	4	1.881 (47.78)	.150 (3.81)	1.744 (44.30)
2	4	1.881 (47.78)	.050 (1.27)	1.744 (44.30)
6	5	2.329 (59.16)	.250 (6.35)	2.192 (55.68)
4	5	2.329 (59.16)	.150 (3.81)	2.192 (55.68)
2	5	2.329 (59.16)	.050 (1.27)	2.192 (55.68)
6	6	2.777 (70.54)	.250 (6.35)	2.640 (67.06)
4	6	2.777 (70.54)	.150 (3.81)	2.640 (67.06)
2	6	2.777 (70.54)	.050 (1.27)	2.640 (67.06)
6	8	3.673 (93.29)	.250 (6.35)	3.536 (89.81)
4	8	3.673 (93.29)	.150 (3.81)	3.536 (89.81)
2	8	3.673 (93.29)	.050 (1.27)	3.536 (89.81)

8 CIRCUIT HOUSING

CIRCUIT SIZE	NO. OF PORTS	DIM. A	DIM. C	DIM. D
10	2	1.200 (30.48)	.450 (11.43)	1.000 (25.40)
8	2	1.200 (30.48)	.350 (8.89)	1.000 (25.40)
6	2	1.200 (30.48)	.250 (6.35)	1.000 (25.40)
10	3	1.750 (44.45)	.450 (11.43)	1.550 (39.37)
8	3	1.750 (44.45)	.350 (8.89)	1.550 (39.37)
6	3	1.750 (44.45)	.250 (6.35)	1.550 (39.37)
4	3	1.750 (44.45)	.150 (3.81)	1.550 (39.37)
10	4	2.300 (58.42)	.450 (11.43)	2.100 (53.34)
8	4	2.300 (58.42)	.350 (8.89)	2.100 (53.34)
4	4	2.300 (58.42)	.150 (3.81)	2.100 (53.34)
4	5	2.850 (72.39)	.450 (11.43)	2.650 (67.31)
10	5	2.850 (72.39)	.350 (8.89)	2.650 (67.31)
8	5	2.850 (72.39)	.250 (6.35)	2.650 (67.31)
10	6	3.400 (86.36)	.450 (11.43)	3.200 (81.28)
8	6	3.400 (86.36)	.350 (8.89)	3.200 (81.28)
10	8	4.500 (114.30)	.450 (11.43)	4.300 (109.22)
8	8	4.500 (114.30)	.350 (8.89)	4.300 (109.22)

ADD BLOCK TOL
EC NO: UCP2009-0477
DRWN: BELL 2008/09/05
CHKD: BELL 2008/09/11
APPR: FSMITH 2008/09/11

DESCRIPTION

REV: K1

QUALITY SYMBOLS

GENERAL TOLERANCES (UNLESS SPECIFIED)

	mm	INCH
4 PLACES	± .15	± .005
3 PLACES	± .10	± .005
2 PLACES	± 0.38	± .015
1 PLACE	± .10	± .005

ANGULAR ±1/2°

DRAFT WHERE APPLICABLE MUST REMAIN WITHIN DIMENSIONS

DIMENSION STYLE IN/MM

SCALE 3:1

DESIGN UNITS INCH

THIRD ANGLE PROJECTION

DRAWN BY JTR DATE 1993/10/18

CHECKED BY JTR DATE 1993/10/18

APPROVED BY RAS DATE 1993/10/18

MATERIAL NO. SEE SHTS 3

SIZE C

MOLEX INCORPORATED

SDA-43223

SHEET NO. 1 OF 6

THIS DRAWING CONTAINS INFORMATION THAT IS PROPRIETARY TO MOLEX INCORPORATED AND SHOULD NOT BE USED WITHOUT WRITTEN PERMISSION

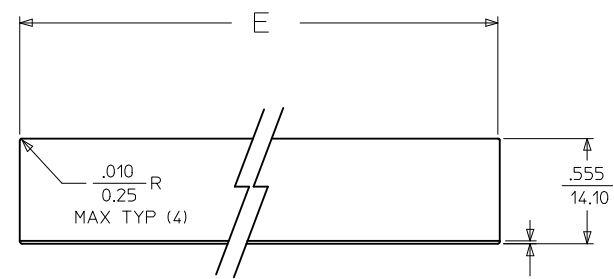
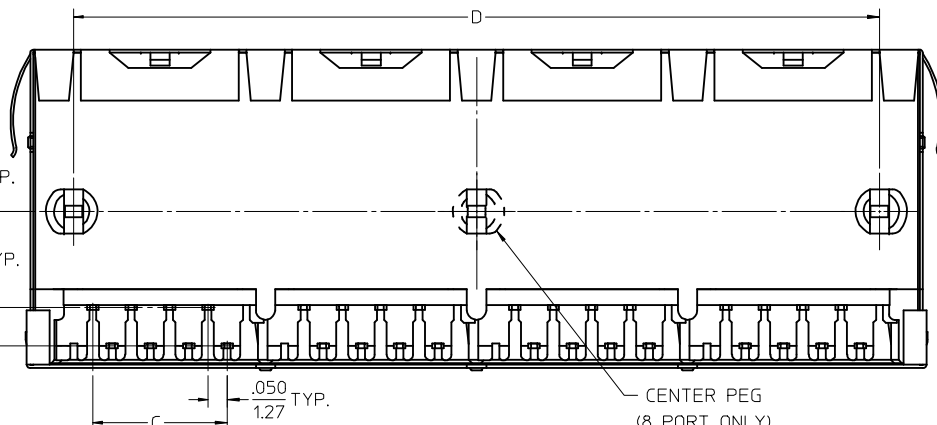
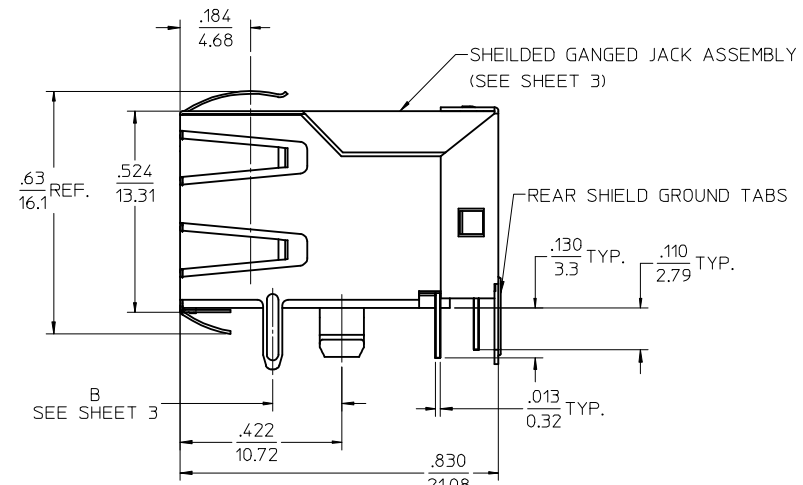
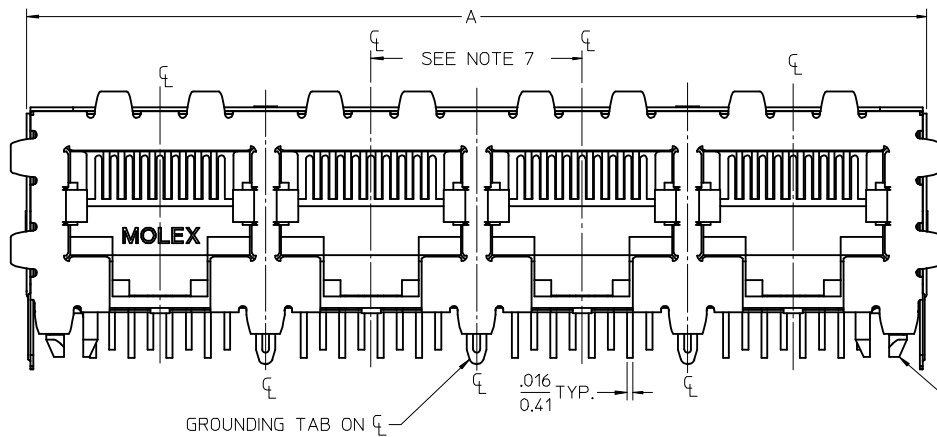

SUGGESTED PANEL OPENING
 .015 TOP OF PCB TO BOTTOM OF OPENING
 .038

SCALE : 2/1

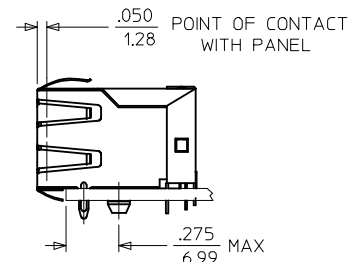

4 PORT 8 LOADED
 8 JACK SHOWN

- NOTES:
- MATERIAL:
 HOUSING: GLASS FILLED NYLON, UL94V-0, COLOR: BLACK
 INSULATOR: GLASS FILLED NYLON, UL94V-0, COLOR: BLACK
 TERMINALS: PHOSPHOR BRONZE: .012/ 0.30 THICK
 SHIELD: BRASS, FRONT .007/ 0.18 THICK, REAR .010/ 0.25 THICK
 - FINISH:
 TERMINALS:
 SELECT GOLD IN CONTACT AREA: 50 MICROINCHES/ 1.27 MICROMETERS MIN.,
 *SELECT TIN IN PC TAIL AREA: 100 MICROINCHES/ 2.54 MICROMETERS MIN.,
 WITH OVERALL NICKEL UNDERPLATE: 50 MICROINCHES/ 1.27 MICROMETERS MIN.
 SHIELD:
 *100 MICROINCHES/ 2.54 MICROMETERS NICKEL OVER 50 MICROINCHES/ 1.27 MICROMETERS COPPER UNDERPLATE. PCB GROUND TABS DIPPED IN TIN
 *THE PRIMARY SHIPPING CARTON WILL BE LABELED "COMPLIANT TO RoHS DIRECTIVE 2002/95/EC AND ELV ANNEX II OF DIRECTIVE 2000/53/EC". CARTONS WITHOUT THIS LABEL MAY CONTAIN PRODUCT WITH TIN-LEAD IN THE PC TAIL AND/OR SHIELD.
 - PRODUCT SPECIFICATION AND PROCESSING PARAMETERS: PS-43223-001.
 - PACKAGING SPECIFICATION:
 SHIELDED CONNECTOR ASSEMBLIES PACKAGED IN TRAYS PER MOLEX PACKAGING SPECIFICATION PK-44150-004.
 - SEE SHEETS 4-6 FOR P.C. BOARD LAYOUTS.
 - REAR SHIELD IS AVAILABLE WITH (1) CENTERED GROUND TAB ON 4 & 8 PORT VERSIONS.
 - 8 CIRCUIT JACKS CENTERLINE TO CENTERLINE SPACING IS .550/ 13.97.
 - ALL UNTOLERANCED DIMENSIONS ARE SHOWN FOR REFERENCE ONLY.
 - THIS PART CONFORMS TO CLASS B REQUIREMENTS OF COSMETIC SPECIFICATION PS-45499-002.

HOUSING SIZE	CIRCUIT SIZE	NO. OF PORTS	DIM. A	DIM. C	DIM. D	DIM. E
8	8	2	1.224 (31.09)	.350 (8.89)	1.000 (25.40)	1.255 (31.88)
8	8	4	2.324 (59.03)	.350 (8.89)	2.100 (53.34)	2.355 (59.82)
8	8	6	3.424 (86.97)	.350 (8.89)	3.200 (81.28)	3.455 (87.76)
8	8	8	4.524 (114.91)	.350 (8.89)	4.300 (109.22)	4.555 (115.97)
8	2	8	4.524 (114.91)	.050 (1.27)	4.300 (109.22)	4.555 (115.97)

SEE SHEET 1 EC NO: UCP2009-0477 DRWN:JBELL CHKD:JBELL APPR:FSMITH 2008/09/05 2008/09/11 2008/09/11	QUALITY SYMBOLS ▽=0 ▽=0	GENERAL TOLERANCES (UNLESS SPECIFIED) mm INCH 4 PLACES ± --- ± --- 3 PLACES ± --- ± .015 2 PLACES ± 0.38 ± --- 1 PLACE ± --- ± --- ANGULAR ± 1/2°	DIMENSION STYLE IN/MM DRAWN BY DATE JTR 1993/10/18 CHECKED BY DATE JTR 1993/10/18 APPROVED BY DATE RAS 1993/10/18	SCALE 4:1 DESIGN UNITS INCH THIRD ANGLE PROJECTION	TITLE LOW PROFILE GANGED, RIGHT ANGLE MODULAR JACK ASSEMBLY MOLEX MOLEX INCORPORATED MATERIAL NO. SEE SHTS 3 DOCUMENT NO. SDA-43223 SHEET NO. 2 OF 6	
	DRAFT WHERE APPLICABLE MUST REMAIN WITHIN DIMENSIONS	THIS DRAWING CONTAINS INFORMATION THAT IS PROPRIETARY TO MOLEX INCORPORATED AND SHOULD NOT BE USED WITHOUT WRITTEN PERMISSION				
	K1	REV				

FLUSH MOUNT (UNSHIELDED)

ASSEMBLY NUMBER	CONNECTOR SIZE	NUMBER OF CIRCUITS	NUMBER OF PORTS	PACKAGING STYLE	PACKAGING SPECIFICATION
43223-6001	6	6	2	TRAY	PK-43249-004
43223-6004	6	6	3	↑	↑
43223-6007	6	6	4		
43223-6010	6	6	5		
43223-6013	6	6	6		
43223-6019	6	6	8		
43223-6022	6	4	2		
43223-6025	6	4	3		
43223-6028	6	4	4		
43223-6031	6	4	5		
43223-6034	6	4	6		
43223-6040	6	4	8		
43223-6043	6	2	2		
43223-6046	6	2	3		
43223-6049	6	2	4		
43223-6052	6	2	5		
43223-6055	6	2	6	↓	↓
43223-6058	6	2	8	TRAY	PK-43249-004

43223-8001	8	10	2	TRAY	PK-43249-004
43223-8004	8	10	3	↑	↑
43223-8007	8	10	4		
43223-8010	8	10	5		
43223-8013	8	10	6		
43223-8019	8	10	8		
43223-8022	8	8	2		
43223-8025	8	8	3		
43223-8028	8	8	4		
43223-8031	8	8	5		
43223-8034	8	8	6		
43223-8040	8	8	8		
43223-8041	8	4	5	↓	↓
43223-8042	8	6	3	TRAY	PK-43249-004

FLANGELESS (UNSHIELDED)

ASSEMBLY NUMBER	CONNECTOR SIZE	NUMBER OF CIRCUITS	NUMBER OF PORTS	PACKAGING STYLE	PACKAGING SPECIFICATION
43223-6101	6	6	2	TRAY	PK-43249-004
43223-6104	6	6	3	↑	↑
43223-6107	6	6	4		
43223-6110	6	6	5		
43223-6113	6	6	6		
43223-6119	6	6	8		
43223-6122	6	4	2		
43223-6125	6	4	3		
43223-6128	6	4	4		
43223-6131	6	4	5		
43223-6134	6	4	6		
43223-6140	6	4	8		
43223-6143	6	2	2		
43223-6146	6	2	3		
43223-6149	6	2	4		
43223-6152	6	2	5		
43223-6155	6	2	6	↓	↓
43223-6158	6	2	8	TRAY	PK-43249-004

43223-8101	8	10	2	TRAY	PK-43249-004
43223-8104	8	10	3	↑	↑
43223-8107	8	10	4		
43223-8110	8	10	5		
43223-8113	8	10	6		
43223-8119	8	10	8		
43223-8122	8	8	2		
43223-8131	8	8	3		
43223-8140	8	8	4		
43223-8149	8	8	5		
43223-8158	8	8	6	↓	↓
43223-8176	8	8	8	TRAY	PK-43249-004

43223-8191	8	6	2	TUBE	PK-43249-005
43223-8192	8	4	4	TUBE	PK-43249-005
43223-8193	8	4	3	TUBE	PK-43249-005
43223-8195	8	8	2	TUBE	PK-43249-005
43223-8196	8	8	3	TUBE	PK-43249-005
43223-8197	8	8	4	TUBE	PK-43249-005

FLANGELESS (SHIELDED)

ASSEMBLY NUMBER	DIMENSION "B"	CONNECTOR SIZE	NUMBER OF CIRCUITS	NUMBER OF PORTS	NUMBER OF REAR SHIELD GROUND TABS	PACKAGING STYLE	PACKAGING SPECIFICATION
43223-8128	.180	8	8	2	1	TRAY	PK-44150-004
43223-8146	.180	8	8	4	3	↑	↑
43223-8164	.180	8	8	6	5		
43223-8182	.180	8	8	8	7		
43223-8185	.180	8	8	8	1		
43223-8188	.180	8	8	4	1	↓	↓
43223-8194	.180	8	2	8	7	TRAY	PK-44150-004

43223-8301	.145	8	8	2	1	TRAY	PK-44150-004
43223-8302	.145	8	8	4	3	↑	↑
43223-8303	.145	8	8	6	5		
43223-8304	.145	8	8	8	7		
43223-8305	.145	8	8	8	1		
43223-8306	.145	8	8	4	1	↓	↓
43223-8307	.145	8	2	8	7	TRAY	PK-44150-004

SNAP FIT PEG VERSIONS

SEE SHEET 1 EC NO: UCP2009-0477 DRWN:JBELL 2008/09/05 CHKD:JBELL 2008/09/11 APPR:FSM/TH 2008/09/11 K1	QUALITY SYMBOLS ▽=0 ▽=0	GENERAL TOLERANCES (UNLESS SPECIFIED)	DIMENSION STYLE IN/MM	SCALE 2:1	DESIGN UNITS INCH	THIRD ANGLE PROJECTION
		4 PLACES ± --- INCH 3 PLACES ± --- ±.015 2 PLACES ± 0.38 ± --- 1 PLACE ± --- ± ---	DRAWN BY DATE JTR 1993/10/18 CHECKED BY DATE JTR 1993/10/18 APPROVED BY DATE RAS 1993/10/18	LOW PROFILE GANGED, RIGHT ANGLE MODULAR JACK ASSEMBLY		
		ANGULAR ±1/2° DRAFT WHERE APPLICABLE MUST REMAIN WITHIN DIMENSIONS	MATERIAL NO. SEE CHART SIZE C	MOLEX INCORPORATED SDA-43223	SHEET NO. 3 OF 6	
		THIS DRAWING CONTAINS INFORMATION THAT IS PROPRIETARY TO MOLEX INCORPORATED AND SHOULD NOT BE USED WITHOUT WRITTEN PERMISSION				

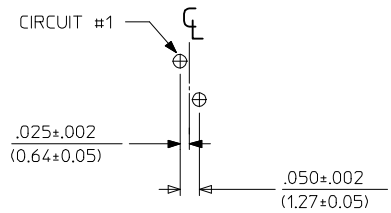

6 LOADED 2 DETAIL
SCALE: 4/1

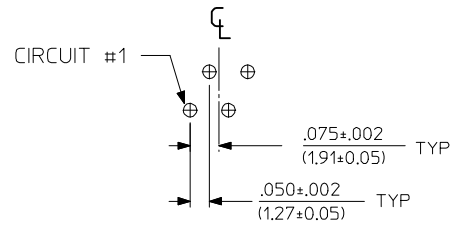

6 LOADED 4 DETAIL
SCALE: 4/1

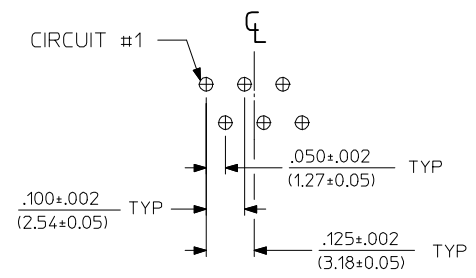

6 LOADED 6 DETAIL
SCALE: 4/1

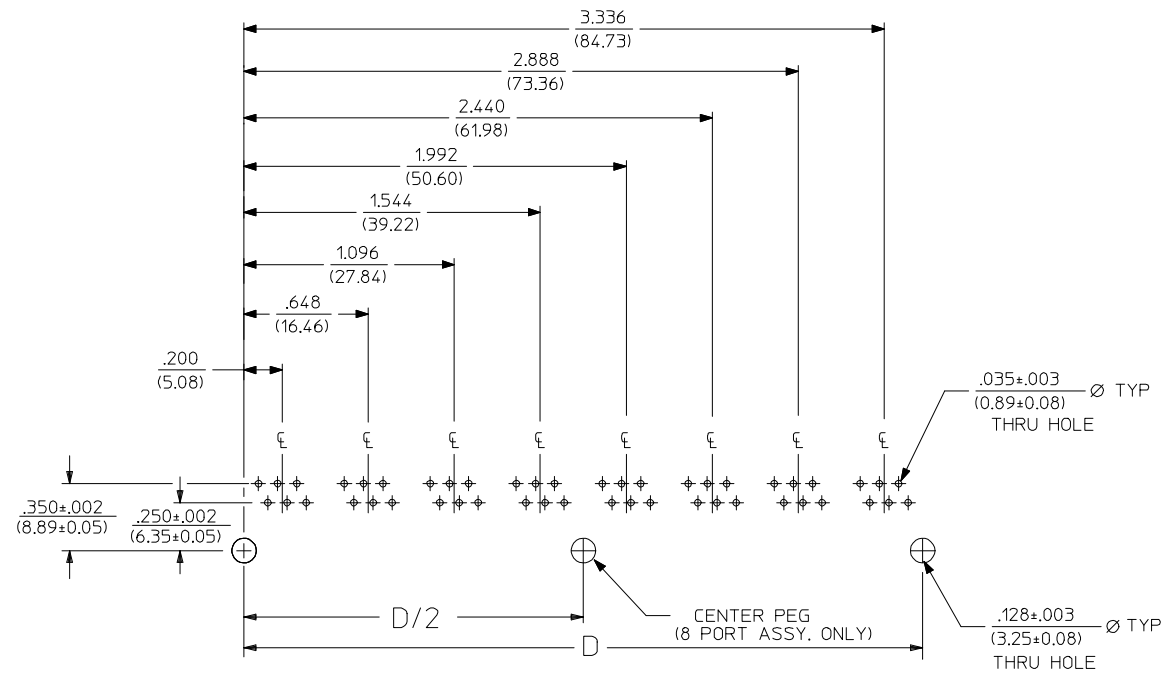

SUGGESTED P.C. BOARD LAYOUT
COMPONENT SIDE OF BOARD
8 PORT, 6 LOADED 6, LAYOUT SHOWN
(SNAP-FIT VERSIONS)

NOTES:
1. RECOMMENDED PCB THICKNESS .062±.005/(1.57±0.13)

NUMBER OF PORTS	DIM. D
2	.848 (21.54)
3	1.296 (32.92)
4	1.744 (44.30)
5	2.192 (55.68)
6	2.640 (67.06)
8	3.536 (89.81)

SEE SHEET 1 EC NO: UCP2009-0477 DRWN:JBELL 2008/09/05 CHKD:JBELL 2008/09/11 APPR:FSM1TH 2008/09/11 K1	QUALITY SYMBOLS ▽=0 ▽=0	GENERAL TOLERANCES (UNLESS SPECIFIED)		DIMENSION STYLE IN/MM	SCALE 2:1	DESIGN UNITS INCH	THIRD ANGLE PROJECTION		
		4 PLACES ± --- ± --- 3 PLACES ± --- ± .015 2 PLACES ± 0.38 ± --- 1 PLACE ± --- ± ---	mm INCH ± --- ± --- ± .015 ± 0.38 ± --- ± --- ± ---	DRAWN BY JTR	DATE 1993/10/18	TITLE LOW PROFILE GANGED, RIGHT ANGLE MODULAR JACK ASSEMBLY			
		ANGULAR ±1/2°		CHECKED BY JTR	DATE 1993/10/18	MOLEX INCORPORATED			
		DRAFT WHERE APPLICABLE MUST REMAIN WITHIN DIMENSIONS		APPROVED BY RAS	DATE 1993/10/18	MATERIAL NO. SEE SHT 3	DOCUMENT NO. SDA-43223	SHEET NO. 4 OF 6	

THIS DRAWING CONTAINS INFORMATION THAT IS PROPRIETARY TO MOLEX INCORPORATED AND SHOULD NOT BE USED WITHOUT WRITTEN PERMISSION

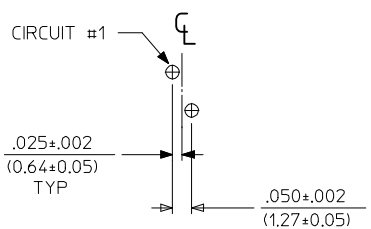

8 LOADED 2 DETAIL
SCALE: 4/1

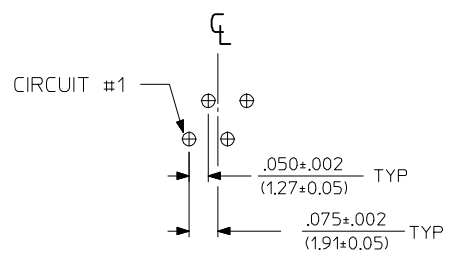

8 LOADED 4 DETAIL
SCALE: 4/1

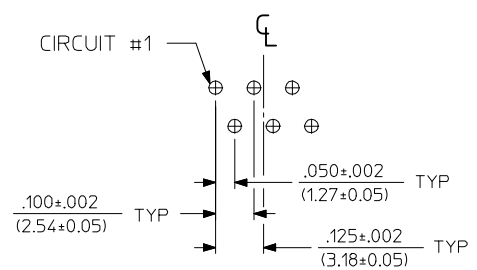

8 LOADED 6 DETAIL
SCALE: 4/1

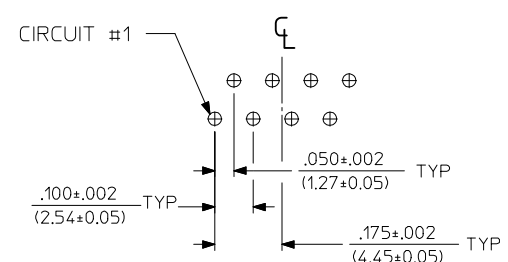

8 LOADED 8 DETAIL
SCALE: 4/1

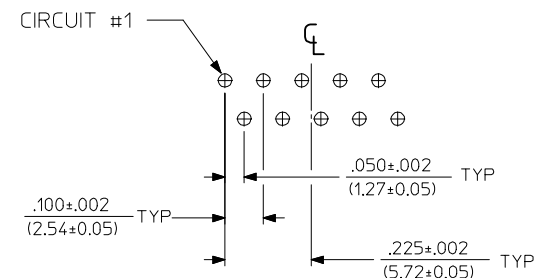

8 LOADED 10 DETAIL
SCALE: 4/1

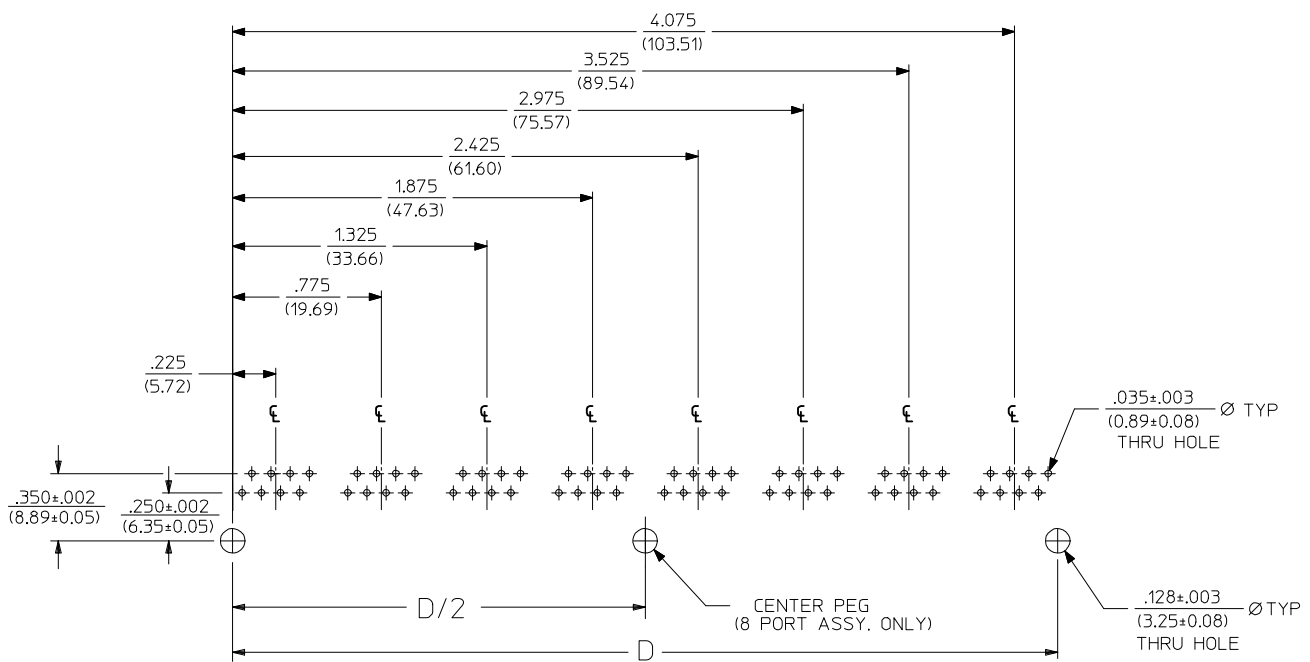

SUGGESTED P.C. BOARD LAYOUT
COMPONENT SIDE OF BOARD
8 PORT, 8 LOADED 8
(SNAP-FIT VERSIONS)

NOTES:
1. RECOMMENDED PCB THICKNESS: .062±.005/(1.57±0.13)

NUMBER OF PORTS	DIM. D
2	1.000 (25.40)
3	1.550 (39.37)
4	2.100 (53.34)
5	2.650 (67.31)
6	3.200 (81.28)
8	4.300 (109.32)

SEE SHEET 1	QUALITY SYMBOLS
EC NO: UCP2009-0477	▽=0
DRWN:JBELL 2008/09/05	▽=0
CHKD:JBELL 2008/09/11	
APPR:FSM/TH 2008/09/11	
REV	DESCRIPTION
K1	

GENERAL TOLERANCES (UNLESS SPECIFIED)	
	mm INCH
4 PLACES ± ---	± ---
3 PLACES ± ---	± .015
2 PLACES ± 0.38	± ---
1 PLACE ± ---	± ---
ANGULAR ±1/2°	
DRAFT WHERE APPLICABLE MUST REMAIN WITHIN DIMENSIONS	

DIMENSION STYLE	
IN/MM	
DRAWN BY	DATE
JTR	1993/10/18
CHECKED BY	DATE
JTR	1993/10/18
APPROVED BY	DATE
RAS	1993/10/18
MATERIAL NO.	DOCUMENT NO.
SEE SHT 3	SDA-43223
SIZE	THIS DRAWING CONTAINS INFORMATION THAT IS PROPRIETARY TO MOLEX INCORPORATED AND SHOULD NOT BE USED WITHOUT WRITTEN PERMISSION

SCALE	DESIGN UNITS	THIRD ANGLE PROJECTION
2:1	INCH	
TITLE		
LOW PROFILE GANGED, RIGHT ANGLE MODULAR JACK ASSEMBLY		
MOLEX MOLEX INCORPORATED		
SHEET NO.		5 OF 6

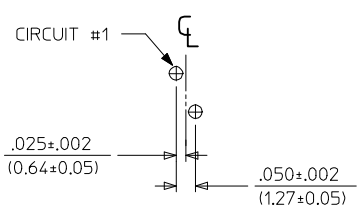

8 LOADED 2 DETAIL
SCALE: 4/1

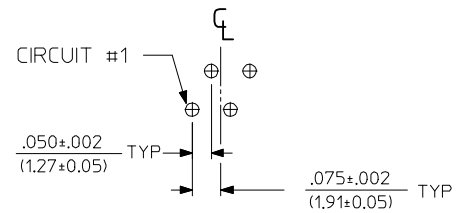

8 LOADED 4 DETAIL
SCALE: 4/1

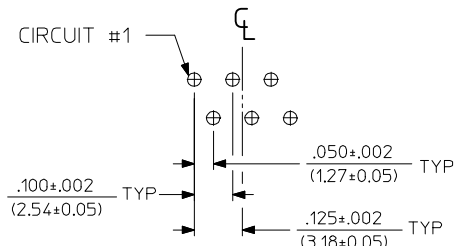

8 LOADED 6 DETAIL
SCALE: 4/1

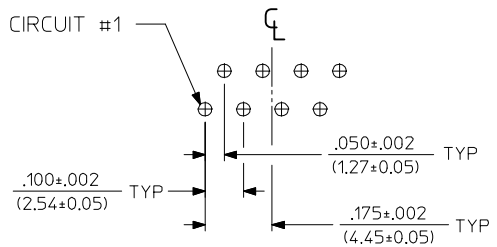

8 LOADED 8 DETAIL
SCALE: 4/1

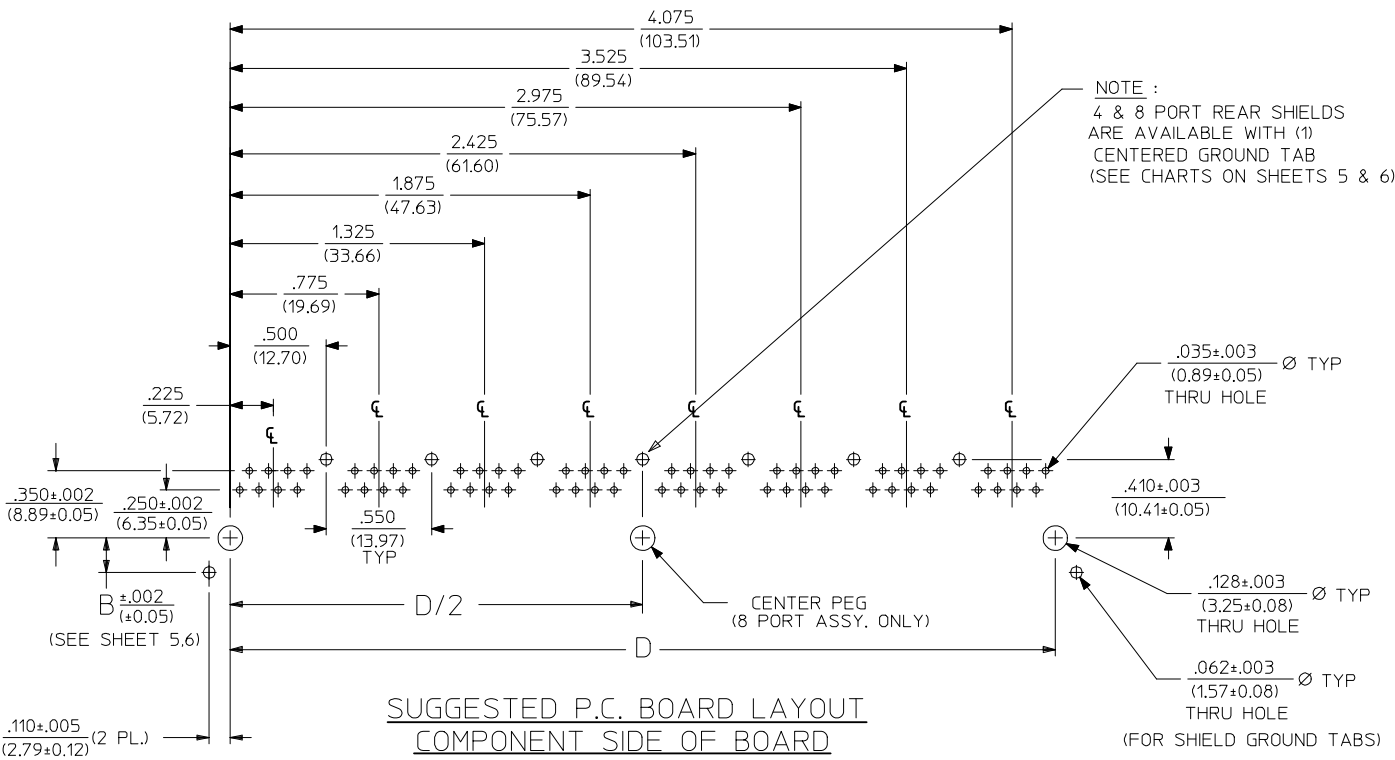

NOTE:
4 & 8 PORT REAR SHIELDS
ARE AVAILABLE WITH (1)
CENTERED GROUND TAB
(SEE CHARTS ON SHEETS 5 & 6)

SUGGESTED P.C. BOARD LAYOUT
COMPONENT SIDE OF BOARD
8 PORT, 8 LOADED 8
(SHIELDED) LAYOUT SHOWN
(SNAP-FIT VERSIONS)

NOTES:
1. RECOMMENDED PCB THICKNESS: .062±.005/(1.57±0.13)

NUMBER OF PORTS	DIM. D
2	1.000 (25.40)
4	2.100 (53.34)
6	3.200 (81.28)
8	4.300 (109.32)

SEE SHEET 1 EC NO: UCP2009-0477 DRWN:JBELL 2008/09/05 CHKD:JBELL 2008/09/11 APPR:FSM/TH 2008/09/11 K1	QUALITY SYMBOLS ▽=0 ▽=0	GENERAL TOLERANCES (UNLESS SPECIFIED) <table border="1"> <thead> <tr> <th></th> <th>mm</th> <th>INCH</th> </tr> </thead> <tbody> <tr> <td>4 PLACES</td> <td>± .---</td> <td>± .---</td> </tr> <tr> <td>3 PLACES</td> <td>± .---</td> <td>± .015</td> </tr> <tr> <td>2 PLACES</td> <td>± 0.38</td> <td>± .---</td> </tr> <tr> <td>1 PLACE</td> <td>± .---</td> <td>± .---</td> </tr> </tbody> </table>		mm	INCH	4 PLACES	± .---	± .---	3 PLACES	± .---	± .015	2 PLACES	± 0.38	± .---	1 PLACE	± .---	± .---	DIMENSION STYLE IN/MM	SCALE 2:1	DESIGN UNITS INCH	THIRD ANGLE PROJECTION
		mm	INCH																		
	4 PLACES	± .---	± .---																		
	3 PLACES	± .---	± .015																		
2 PLACES	± 0.38	± .---																			
1 PLACE	± .---	± .---																			
DRAFT WHERE APPLICABLE MUST REMAIN WITHIN DIMENSIONS		MATERIAL NO. SEE SHT 3	DRAWN BY JTR	DATE 1993/10/18	TITLE LOW PROFILE GANGED, RIGHT ANGLE MODULAR JACK ASSEMBLY																
		APPROVED BY RAS	DATE 1993/10/18	MOLEX MOLEX INCORPORATED																	
		SIZE C	DOCUMENT NO. SDA-43223		SHEET NO. 6 OF 6																