

PLEASE CHECK WWW.MOLEX.COM FOR LATEST PART INFORMATION

Part Number: [0345661703](#)
Status: **Active**
Overview: [mx123 sealed connection systems](#)
Description: 2.54mm (.100") Pitch, MX123 Female Receptacle Housing, Keying Option E, Wire Dress Option 9, 73 Circuits, Green TPA

Documents:

[Drawing \(PDF\)](#) [RoHS Certificate of Compliance \(PDF\)](#)
[Product Specification PS-34566-0000 \(PDF\)](#)

General

Product Family	Crimp Housings
Series	34566
Comments	See Sales Drawing for number of Open Circuits
Overview	mx123 sealed connection systems
Product Name	MX123

Physical

Circuits (maximum)	73
Circuits Detail	73
Color - Resin	Green
Gender	Female
Glow-Wire Compliant	No
Keying to Mating Part	Yes
Lock to Mating Part	Yes
Material - Resin	Nylon
Number of Rows	4
Packaging Type	Tray
Panel Mount	No
Pitch - Mating Interface (in)	0.100 In
Pitch - Mating Interface (mm)	2.54 mm
Pitch - Term. Interface (in)	0.100 In
Pitch - Term. Interface (mm)	2.54 mm
Polarized to Mating Part	Yes
Stackable	No
Temperature Range - Operating	-40°C to +125°C

Electrical

Current - Maximum per Contact	11A, 25A
-------------------------------	----------

Material Info

Reference - Drawing Numbers

Application Specification	AS-34566-001
Product Specification	PS-34566-0000

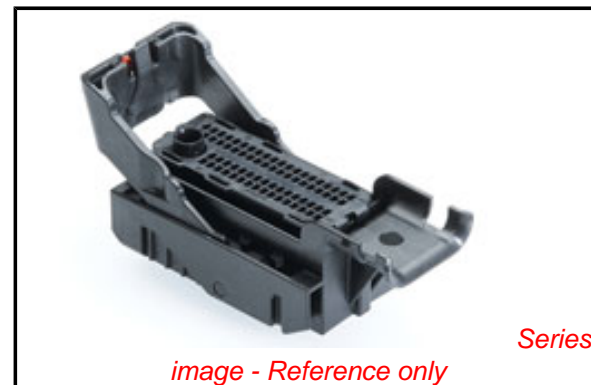

EU RoHS

ELV and RoHS Compliant
REACH SVHC
 Not Reviewed
Halogen-Free
Status
Not Reviewed

China RoHS



Need more information on product environmental compliance?

Email productcompliance@molex.com
 For a multiple part number RoHS Certificate of Compliance, [click here](#)

Please visit the [Contact Us](#) section for any non-product compliance questions.

Search Parts in this Series

[34566Series](#)

Mates With

MX123 Female Header [31386](#) , [31387](#)

Use With

MX64 Female Terminals [33467](#)

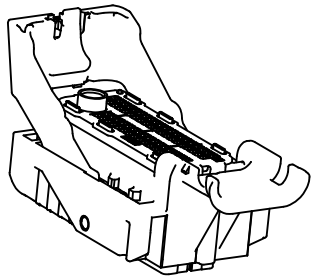

73 CKT
SCALE 3:2

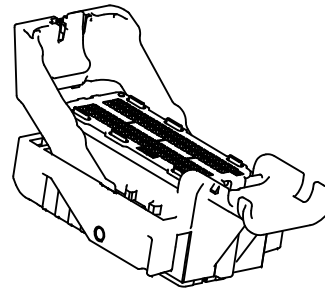
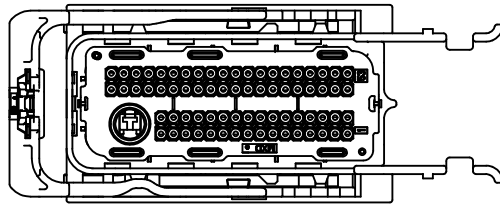

80 CKT
SCALE 3:2

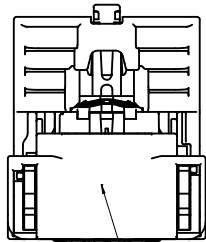

RECOMMENDED LOCATION
FOR NOTE 2D

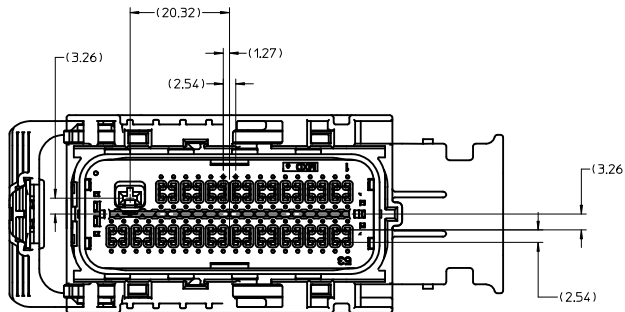
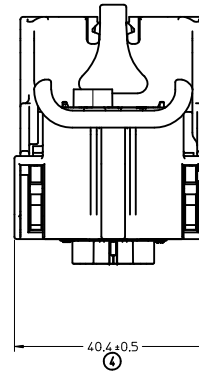
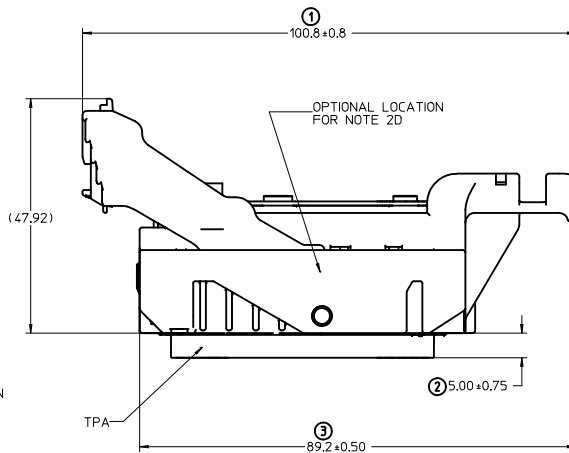

NOTES: UNLESS OTHERWISE SPECIFIED

1. MATERIAL:

- A. RESIN: SEE COMPONENT DRAWINGS
- B. COLOR: SEE TABLE

2. DESIGN - GENERAL:

- A. THIS IS A 100% CAD GENERATED PART. THE CAD MATHEMATICAL DATA IS THE MASTER FOR THIS PART. FOR DIMENSIONAL OR ANY INFORMATION NOT SHOWN ON THIS DRAWING, ANALYZE THE CAD MODEL.
- B. TOLERANCES:
 - a. LINEAR XX ± 0.30
 - XXX ± 0.10
 - XXXX ± 0.10
 - b. ANGULAR X° ± 3.0°
- C. CORNERS SHOWN AS SHARP TO BE R 0.2 MAX.
- D. FOLLOWING PRODUCTION CODES TO BE PERMANENTLY MARKED & HUMAN READABLE TO A LETTER HEIGHT < 3mm.
 - LINE #1: MATERIAL #: XXXX-XXXX
 - LINE #2: DATE CODE: JJYY (JULIAN DAY, LAST DIGIT OF YEAR)
 - LINE #3: INSPECTION MACHINE CODE # SERIAL #X_XXXX
- E-1. PARTS MUST BE FREE OF DISCOLORATION, SALT RESIDUE AND OTHER IMPERFECTIONS THAT AFFECT FIT OR FUNCTION.
- E-2. SCRATCHES OR DENTS NOT TO EXCEED 0.10mm IN DEPTH.
- F. CHANGES IN DESIGN FROM PART PREVIOUSLY APPROVED REQUIRES PRIOR ENGINEERING APPROVAL. THIS INCLUDES BUT IS NOT LIMITED TO DRAFT, MATERIAL OR PROCESSING.
- G. SHALL CONFORM TO THE FOLLOWING PACKAGING SPECIFICATION 300-019

3. DESIGN - MANUFACTURING:

- A. DRAFT TO BE WITHIN TOLERANCE.
- B. ALLOWABLE FLASH 0.2 MAX HIGH X 0.13 MAX THICK.
- C. ALLOWABLE PARTING LINE MISMATCH 0.2 MAX.
- D. EJECTOR PINS MARK TO BE FLUSH TO 0.25 MAX DEPRESSED.
- E. ALLOWABLE GATE VESTIGE TO BE FLUSH TO 0.25 MAX PROTRUSION.

4. SYSTEM REQUIREMENTS:

WHEN TESTED TO SAE/USCAR-2 REV. 3, APRIL 2001, AND GMW #3191, AUGUST 22, 2000 (DRAFT).

- A. TPA (WITHOUT TERMINALS)
 - a. INSERTION FORCE FROM PRE-SET TO LOCK: ≥20
 - b. REMOVAL FORCE FROM PRE-SET: ≥20
- B. CPA
 - a. INSERTION FORCE FROM PRE-SET TO LOCK WITH CONNECTOR UN-MATED: ≥60N
 - b. REMOVAL FORCE FROM PRE-SET: ≥30N
- C. GROMMET CAP
 - a. REMOVAL FORCE FROM HOUSING WITH ENGAGED LATCHES: ≥110N
- D. MATE ASSIST LEVER
 - a. INADVERTENT ACTUATION FORCE DURING SHIPPING, HANDLING OR PRE-ASSEMBLY: ≥190N

F40	REVISED DRAWING---CIRCUIT 73 IS OPEN ON MATERIAL NUMBER 34566-2983
F39	ADD PART NUMBERS
F38	ADD PART NUMBERS
F37	ADD PART NUMBERS
F36	ADD PART NUMBERS
F35	ADD PART NUMBERS
F34	ADD PART NUMBERS
F33	ADD PART NUMBERS
F32	ADD PART NUMBERS & SHEET 33
F31	ADD PART NUMBERS
F30	ASSY # 34566-2683---KEY OPT H WAS A. COLOR ST BRY WAS BLACK
F29	ADD PART NUMBERS
REV	DESCRIPTION

ENTER DESCRIPTION DEC NO: UAU2010-1551 DRAWN BY: 2010/03/15 CHYK/DGR/FF/THS 2008/05/09 APPROV: VKOSHY 2010/03/18	QUALITY SYMBOLS ▽=0 ▽=0	GENERAL TOLERANCES (UNLESS SPECIFIED)		DIMENSION STYLE MM ONLY		SCALE 2:1	DESIGN UNITS METRIC	THIRD ANGLE PROJECTION	
		4 PLACES ±---+--- 3 PLACES ±---+--- 2 PLACES ±---+--- 1 PLACE ±---+---	mm INCH	DRAWN BY SRAJENDRANAT	DATE 2008/05/09	TITLE MX123 73/80 CKT HRNS CONN ASSY			
		ANGULAR ±---°		CHECKED BY TSKIVER	DATE 2008/05/09	MOLEX INCORPORATED			
		DRAFT WHERE APPLICABLE MUST REMAIN WITHIN DIMENSIONS		APPROVED BY VKOSHY	DATE 2010/03/18	SEE BOM TABLE		DOCUMENT NO. SD-34566-001	SHEET NO. 1 OF 36

20 19 18 17 16 15 14 13 12 11 10 9 8 7 6 5 4 3 2 1

WIRE DRESS OPTION 0
HOUSING ONLY, SHOWN FOR CLARITY

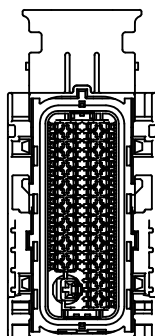

73 CKT
KEY OPTION A

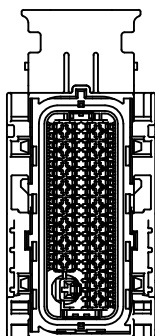

73 CKT
KEY OPTION B

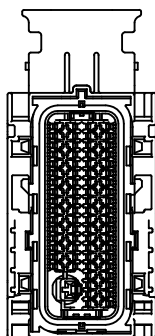

73 CKT
KEY OPTION C

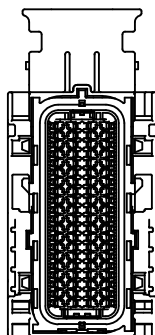

80 CKT
KEY OPTION G

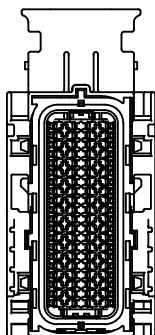

80 CKT
KEY OPTION H

ENTER DESCRIPTION REC NO: UAU2010-1551 DRAWN BY: 2010/03/15 CHKD BY: FFH 2008/05/09 APPR: VKOSHY 2010/03/18 T40 REV:	QUALITY SYMBOLS ▽=0 ▽=0	GENERAL TOLERANCES (UNLESS SPECIFIED) <table border="1"> <thead> <tr> <th></th> <th>mm</th> <th>INCH</th> </tr> </thead> <tbody> <tr> <td>4 PLACES</td> <td>±---</td> <td>±---</td> </tr> <tr> <td>3 PLACES</td> <td>±---</td> <td>±---</td> </tr> <tr> <td>2 PLACES</td> <td>±---</td> <td>±---</td> </tr> <tr> <td>1 PLACE</td> <td>±---</td> <td>±---</td> </tr> <tr> <td colspan="3">ANGULAR ±----</td> </tr> </tbody> </table>		mm	INCH	4 PLACES	±---	±---	3 PLACES	±---	±---	2 PLACES	±---	±---	1 PLACE	±---	±---	ANGULAR ±----			DIMENSION STYLE MM ONLY	SCALE 1.5:1	DESIGN UNITS METRIC	THIRD ANGLE PROJECTION
		mm	INCH																					
	4 PLACES	±---	±---																					
	3 PLACES	±---	±---																					
2 PLACES	±---	±---																						
1 PLACE	±---	±---																						
ANGULAR ±----																								
DRAWN BY: SRAJENDRANAT CHECKED BY: TSK IVER APPROVED BY: VKOSHY	DATE: 2008/05/09 DATE: 2008/05/09 DATE: 2010/03/18	MATERIAL NO. SEE BOM TABLE	TITLE MX123 73/80 CKT HRNS CONN ASSY	DOCUMENT NO. SD-34566-001	SHEET NO. 2 OF 36	Molex MOLEX INCORPORATED																		
DRAFT WHERE APPLICABLE MUST REMAIN WITHIN DIMENSIONS																								
THIS DRAWING CONTAINS INFORMATION THAT IS PROPRIETARY TO MOLEX INCORPORATED AND SHOULD NOT BE USED WITHOUT WRITTEN PERMISSION																								

19 18 17 16 15 14 13 12 11 10 9 8 7 6 5 4 3 2 1

20 19 18 17 16 15 14 13 12 11 10 9 8 7 6 5 4 3 2 1

WIRE DRESS OPTION 9
HOUSING ONLY, SHOWN FOR CLARITY

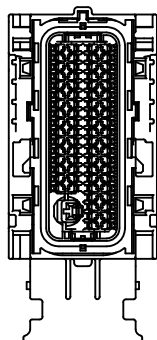

73 CKT
KEY OPTION A

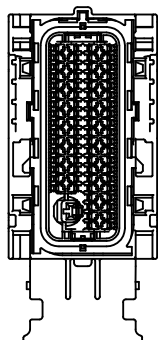

73 CKT
KEY OPTION B

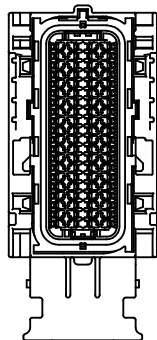

80 CKT
KEY OPTION G

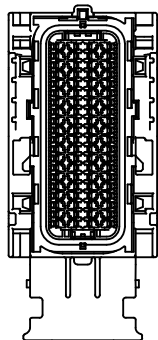

80 CKT
KEY OPTION H

ENTER DESCRIPTION REC NO: UAU2010-1551 DRAWN BY: 2010/03/15 CHKD BY: FFJHS 2008/05/09 APPR: VKOSHY 2010/03/18 T40	QUALITY SYMBOLS ▽=0 ▽=0	GENERAL TOLERANCES (UNLESS SPECIFIED) mm INCH 4 PLACES # --- # --- 3 PLACES # --- # --- 2 PLACES # --- # --- 1 PLACE # --- # --- ANGULAR ± ---°	DIMENSION STYLE MM ONLY DRAWN BY: SRAJENDRANAT DATE: 2008/05/09 CHECKED BY: TSK IVER DATE: 2008/05/09 APPROVED BY: VKOSHY DATE: 2010/03/18	SCALE 1.5:1 DESIGN UNITS METRIC THIRD ANGLE PROJECTION	TITLE MX123 73/80 CKT HRNS CONN ASSY
	DRAFT WHERE APPLICABLE MUST REMAIN WITHIN DIMENSIONS		MATERIAL NO. SEE BOM TABLE	DOCUMENT NO. SD-34566-001	SHEET NO. 3 OF 36
	THIS DRAWING CONTAINS INFORMATION THAT IS PROPRIETARY TO MOLEX INCORPORATED AND SHOULD NOT BE USED WITHOUT WRITTEN PERMISSION				
	MOLEX INCORPORATED				

19 18 17 16 15 14 13 12 11 10 9 8 7 6 5 4 3 2 1

WIRE DRESS OPTION 0

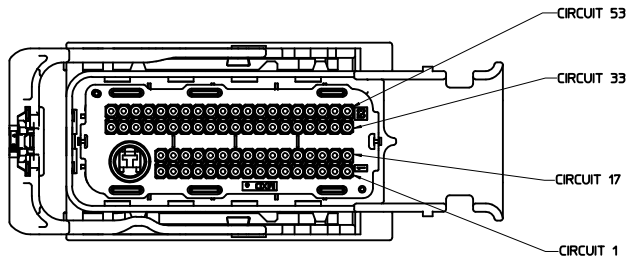

73 CKT

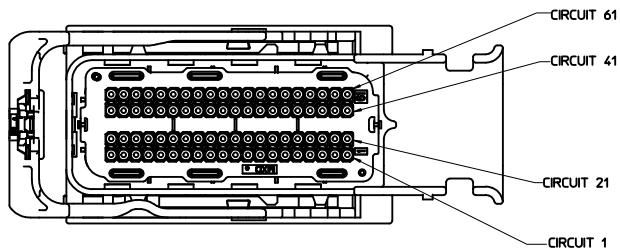

80 CKT

WIRE DRESS OPTION 9

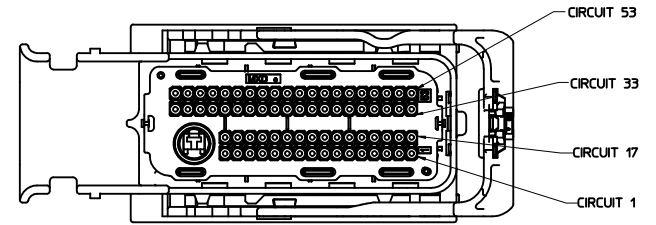

73 CKT

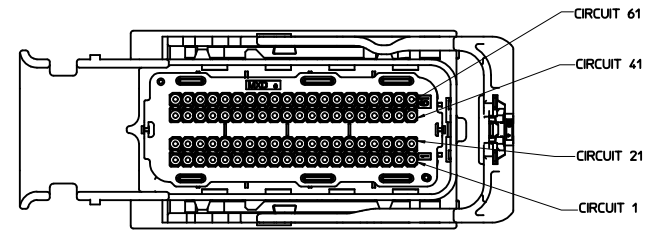

80 CKT

ENTER DESCRIPTION ECN NO: UAU2010-1551 DRAWN BY: DRWNAH01 CHECKED BY: CHKDGRFFHIS APPROVED BY: APPR.VKOSHY DATE: 2010/03/15 DATE: 2008/05/09 DATE: 2010/03/18	QUALITY SYMBOLS ▽=0 ▽=0	GENERAL TOLERANCES (UNLESS SPECIFIED)		DIMENSION STYLE MM ONLY	SCALE 2:1	DESIGN UNITS METRIC	THIRD ANGLE PROJECTION		
		4 PLACES ±---+--- 3 PLACES ±---+--- 2 PLACES ±---+--- 1 PLACE ±---+---	mm INCH	DRAWN BY DATE SRAJENDRANAT 2008/05/09	TITLE MX123 73/80 CKT HRNS CONN ASSY				
		ANGULAR ±---°	DRAFT WHERE APPLICABLE MUST REMAIN WITHIN DIMENSIONS	CHECKED BY DATE TSKIVER 2008/05/09	MOLEX INCORPORATED				
		APPROVED BY DATE VKOSHY 2010/03/18	MATERIAL NO. SEE BOM TABLE	DOCUMENT NO. SD-34566-001	SHEET NO. 4 OF 36				

STATUS	GM PART #	MATERIAL #	PART/MATERIAL REVISION	WIRE DRESS OPTION	KEY OPTION ▽	COLOR (TPA) ▽	NUMBERS INDICATE CAVITIES OPEN FOR CIRCUITS ▽																																					
AVAILABLE	12582677	34566-0103	G	0	A	BLACK																																						
AVAILABLE	12582678	34566-0203	G	0	B	ST GRAY	72	71	70	69	68	67	66	65	64	63	62	61	60	59	58	57	56	55	54	53																		
AVAILABLE	12615654	34566-0303	G	0	C	BLUE	52	51	50	49	48	47	46	45	44	43	42	41	40	39	38	37	36	35	34	33																		
ACTIVE	TBD	34566-0403	G	0	D	BROWN	73							32	31	30	29	28	27	26	25	24	23	22	21	20	19	18	17															
ACTIVE	TBD	34566-0503	G	0	E	GREEN								16	15	14	13	12	11	10	9	8	7	6	5	4	3	2	1															
ACTIVE	TBD	34566-0603	G	0	F	NATURAL																																						
AVAILABLE	12588057	34566-0703	G	0	G	BLUE																																						
AVAILABLE	12588058	34566-0803	G	0	H	ST GRAY	80	79	78	77	76	75	74	73	72	71	70	69	68	67	66	65	64	63	62	61																		
ACTIVE	TBD	34566-0903	G	0	J	BLACK	60	59	58	57	56	55	54	53	52	51	50	49	48	47	46	45	44	43	42	41																		
ACTIVE	TBD	34566-1003	G	0	K	BROWN	40	39	38	37	36	35	34	33	32	31	30	29	28	27	26	25	24	23	22	21	20	19	18	17														
ACTIVE	TBD	34566-1103	G	0	L	GREEN																																						
ACTIVE	TBD	34566-1203	G	0	M	NATURAL																																						
AVAILABLE	12603596	34566-1303	G	9	A	BLACK																																						
AVAILABLE	12603597	34566-1403	G	9	B	ST GRAY	72	71	70	69	68	67	66	65	64	63	62	61	60	59	58	57	56	55	54	53																		
AVAILABLE	12615655	34566-1503	G	9	C	BLUE	52	51	50	49	48	47	46	45	44	43	42	41	40	39	38	37	36	35	34	33																		
ACTIVE	TBD	34566-1603	G	9	D	BROWN	73							32	31	30	29	28	27	26	25	24	23	22	21	20	19	18	17															
ACTIVE	TBD	34566-1703	G	9	E	GREEN								16	15	14	13	12	11	10	9	8	7	6	5	4	3	2	1															
ACTIVE	TBD	34566-1803	G	9	F	NATURAL																																						
AVAILABLE	12603598	34566-1903	G	9	G	BLUE																																						
AVAILABLE	12603599	34566-2003	G	9	H	ST GRAY	80	79	78	77	76	75	74	73	72	71	70	69	68	67	66	65	64	63	62	61																		
ACTIVE	TBD	34566-2103	G	9	J	BLACK	60	59	58	57	56	55	54	53	52	51	50	49	48	47	46	45	44	43	42	41																		
ACTIVE	TBD	34566-2203	G	9	K	BROWN	40	39	38	37	36	35	34	33	32	31	30	29	28	27	26	25	24	23	22	21	20	19	18	17														
ACTIVE	TBD	34566-2303	G	9	L	GREEN																																						
ACTIVE	TBD	34566-2403	G	9	M	NATURAL																																						
N/A	N/A	N/A	N/A	N/A	N/A	N/A																																						
AVAILABLE	NOT APPLICABLE	34566-2503	G	0	A	BLACK	72	71	70	69	68	67	66	65	64	63	62	61	60	59	58	57	56	55	54	53																		
							52	51	50	49	48	47	46	45	44	43	42	41	40	39	38	37	36	35	34	33																		
							73							32	31	30	29	28	27	26	25	24	23	22	21	20	19	18	17															
														14	13	12	11	10	9	8	7	6	5	4	3	2	1																	
AVAILABLE	NOT APPLICABLE	34566-2603	G	0	B	ST GRAY								67	66	65	64	63	62	61	60	59	58	57	56	55	54	53																
														49	48	47	46	45	44	43	42	41	40	39	38	37	36	35	34	33														
														73							29	28	27	26	25	24	23	22	21	20	19	18	17											
																					7	6	5	4	3	2	1																	
AVAILABLE	NOT APPLICABLE	34566-2703	G	0	B	ST GRAY								65	64	63	62	61	60	59	58	57	56	55	54	53																		
														49	48	47	46	45	44	43	42	41	40	39	38	37	36	35	34	33														
														73							29	28	27	26	25	24	23	22	21	20	19	18	17											
																					7	6	5	4	3	2	1																	

SEE NEXT PAGE FOR ADDITIONAL NUMBERS

ENTER DESCRIPTION EC NO: UAU2010-1551 DRAWN BY: DRWNAH01 CHECKED BY: CHKDORFF APPROVED BY: APPRVKOSHY DATE: 2010/03/15 DATE: 2008/05/09 DATE: 2010/03/18 REV: F40	QUALITY SYMBOLS ▽=0 ▽=0	GENERAL TOLERANCES (UNLESS SPECIFIED) mm INCH 4 PLACES ±--- ±--- 3 PLACES ±--- ±--- 2 PLACES ±--- ±--- 1 PLACE ±--- ±--- ANGULAR ±---°	DIMENSION STYLE MM ONLY	SCALE 1:1	DESIGN UNITS METRIC	THIRD ANGLE PROJECTION	
	DRAWN BY: SRAJENDRANAT CHECKED BY: TSKIVER APPROVED BY: VKOSHY DATE: 2008/05/09 DATE: 2008/05/09 DATE: 2010/03/18	DATE: 2008/05/09 DATE: 2008/05/09 DATE: 2010/03/18	DATE: 2008/05/09 DATE: 2008/05/09 DATE: 2010/03/18	DATE: 2008/05/09 DATE: 2008/05/09 DATE: 2010/03/18	DATE: 2008/05/09 DATE: 2008/05/09 DATE: 2010/03/18	DATE: 2008/05/09 DATE: 2008/05/09 DATE: 2010/03/18	DATE: 2008/05/09 DATE: 2008/05/09 DATE: 2010/03/18
	TITLE: MX123 73/80 CKT HRNS CONN ASSY						
	MOLEX INCORPORATED MATERIAL NO. SD-34566-001 DOCUMENT NO. SD-34566-001 SHEET NO. 5 OF 36						

THIS DRAWING CONTAINS INFORMATION THAT IS PROPRIETARY TO MOLEX INCORPORATED AND SHOULD NOT BE USED WITHOUT WRITTEN PERMISSION

20 19 18 17 16 15 14 13 12 11 10 9 8 7 6 5 4 3 2 1

STATUS	GM PART #	MATERIAL #	PART/MATERIAL REVISION	WIRE DRESS OPTION	KEY OPTION	COLOR (TPA)	NUMBERS INDICATE CAVITIES OPEN FOR CIRCUITS																																																																																											
AVAILABLE	NOT APPLICABLE	34566-2803	G	0	H	ST GRY	[Grid]																																																																																											
AVAILABLE	NOT APPLICABLE	34566-2903	G	0	A	BLACK	<table border="1"> <tr><td>72</td><td>71</td><td>70</td><td>69</td><td>68</td><td>67</td><td>66</td><td>64</td><td>63</td><td>62</td><td>61</td><td>59</td><td></td><td></td><td></td><td></td><td>55</td><td>54</td><td>53</td></tr> <tr><td>52</td><td>51</td><td>49</td><td>48</td><td>47</td><td>46</td><td></td><td>44</td><td>43</td><td>42</td><td>41</td><td>39</td><td></td><td></td><td></td><td></td><td>35</td><td>34</td><td>33</td></tr> <tr><td></td><td></td><td>73</td><td>32</td><td>31</td><td>29</td><td></td><td>27</td><td></td><td>25</td><td></td><td>23</td><td></td><td></td><td></td><td></td><td>19</td><td>18</td><td>17</td></tr> <tr><td></td><td></td><td></td><td>16</td><td></td><td>13</td><td>12</td><td>11</td><td></td><td>9</td><td>8</td><td>7</td><td>6</td><td>5</td><td>4</td><td>3</td><td>2</td><td>1</td><td></td></tr> </table>																72	71	70	69	68	67	66	64	63	62	61	59					55	54	53	52	51	49	48	47	46		44	43	42	41	39					35	34	33			73	32	31	29		27		25		23					19	18	17				16		13	12	11		9	8	7	6	5	4	3	2	1	
72	71	70	69	68	67	66	64	63	62	61	59					55	54	53																																																																																
52	51	49	48	47	46		44	43	42	41	39					35	34	33																																																																																
		73	32	31	29		27		25		23					19	18	17																																																																																
			16		13	12	11		9	8	7	6	5	4	3	2	1																																																																																	
AVAILABLE	NOT APPLICABLE	34566-3003	G	0	A	BLACK	<table border="1"> <tr><td>72</td><td>71</td><td>70</td><td>69</td><td>68</td><td>67</td><td>66</td><td>64</td><td>63</td><td>62</td><td>61</td><td>59</td><td>58</td><td>57</td><td>56</td><td>55</td><td>54</td><td>53</td></tr> <tr><td>52</td><td>51</td><td>50</td><td>49</td><td>48</td><td>47</td><td>46</td><td>44</td><td>43</td><td>42</td><td>41</td><td>40</td><td>39</td><td>38</td><td>37</td><td>36</td><td>35</td><td>34</td><td>33</td></tr> <tr><td></td><td></td><td>73</td><td>32</td><td>31</td><td>30</td><td>29</td><td>28</td><td>27</td><td>25</td><td>24</td><td>23</td><td>22</td><td>21</td><td>20</td><td>19</td><td>18</td><td>17</td></tr> <tr><td></td><td></td><td></td><td>16</td><td>15</td><td>14</td><td>13</td><td>12</td><td>11</td><td>9</td><td>8</td><td>7</td><td>6</td><td>5</td><td>4</td><td>3</td><td>2</td><td>1</td><td></td></tr> </table>																72	71	70	69	68	67	66	64	63	62	61	59	58	57	56	55	54	53	52	51	50	49	48	47	46	44	43	42	41	40	39	38	37	36	35	34	33			73	32	31	30	29	28	27	25	24	23	22	21	20	19	18	17				16	15	14	13	12	11	9	8	7	6	5	4	3	2	1			
72	71	70	69	68	67	66	64	63	62	61	59	58	57	56	55	54	53																																																																																	
52	51	50	49	48	47	46	44	43	42	41	40	39	38	37	36	35	34	33																																																																																
		73	32	31	30	29	28	27	25	24	23	22	21	20	19	18	17																																																																																	
			16	15	14	13	12	11	9	8	7	6	5	4	3	2	1																																																																																	
AVAILABLE	NOT APPLICABLE	34566-3103	G	0	B	ST GRY	<table border="1"> <tr><td></td><td></td><td></td><td></td><td></td><td></td><td></td><td>65</td><td></td><td>62</td><td></td><td>59</td><td>57</td><td>55</td><td>53</td><td></td><td></td><td></td><td></td></tr> <tr><td></td><td></td><td>49</td><td>48</td><td></td><td>46</td><td></td><td></td><td></td><td>42</td><td></td><td>39</td><td>37</td><td>35</td><td>33</td><td></td><td></td><td></td><td></td></tr> <tr><td></td><td></td><td></td><td></td><td></td><td></td><td></td><td>29</td><td></td><td>26</td><td></td><td>23</td><td>21</td><td></td><td>18</td><td></td><td></td><td></td><td></td></tr> <tr><td></td><td></td><td>73</td><td></td><td></td><td>15</td><td></td><td></td><td></td><td></td><td>9</td><td>8</td><td>7</td><td></td><td>4</td><td>3</td><td></td><td></td><td></td></tr> </table>																							65		62		59	57	55	53							49	48		46				42		39	37	35	33												29		26		23	21		18							73			15					9	8	7		4	3			
							65		62		59	57	55	53																																																																																				
		49	48		46				42		39	37	35	33																																																																																				
							29		26		23	21		18																																																																																				
		73			15					9	8	7		4	3																																																																																			
AVAILABLE	NOT APPLICABLE	34566-3203	G	0	B	ST GRY	<table border="1"> <tr><td></td><td></td><td></td><td></td><td></td><td>67</td><td></td><td></td><td></td><td></td><td></td><td>60</td><td>59</td><td>58</td><td>57</td><td>56</td><td>55</td><td>53</td></tr> <tr><td></td><td></td><td>50</td><td>49</td><td>48</td><td></td><td>46</td><td></td><td></td><td></td><td></td><td>39</td><td>38</td><td>37</td><td>36</td><td>35</td><td>34</td><td>33</td></tr> <tr><td></td><td></td><td></td><td></td><td></td><td></td><td></td><td>29</td><td></td><td></td><td></td><td>23</td><td>22</td><td>21</td><td></td><td>18</td><td></td><td></td></tr> <tr><td></td><td></td><td>73</td><td></td><td></td><td>16</td><td>15</td><td>14</td><td></td><td></td><td></td><td>7</td><td>6</td><td>5</td><td>4</td><td>3</td><td></td><td></td></tr> </table>																					67						60	59	58	57	56	55	53			50	49	48		46					39	38	37	36	35	34	33								29				23	22	21		18					73			16	15	14				7	6	5	4	3						
					67						60	59	58	57	56	55	53																																																																																	
		50	49	48		46					39	38	37	36	35	34	33																																																																																	
							29				23	22	21		18																																																																																			
		73			16	15	14				7	6	5	4	3																																																																																			
AVAILABLE	NOT APPLICABLE	34566-3303	G	0	B	ST GRY	<table border="1"> <tr><td></td><td></td><td></td><td></td><td></td><td></td><td></td><td></td><td></td><td></td><td></td><td>59</td><td>58</td><td>57</td><td>56</td><td>55</td><td>53</td></tr> <tr><td></td><td></td><td>50</td><td>49</td><td>48</td><td></td><td>46</td><td></td><td></td><td></td><td></td><td>39</td><td>38</td><td>37</td><td>36</td><td>35</td><td>34</td><td>33</td></tr> <tr><td></td><td></td><td></td><td></td><td></td><td></td><td></td><td>29</td><td></td><td></td><td></td><td>23</td><td>22</td><td>21</td><td></td><td>18</td><td></td><td></td></tr> <tr><td></td><td></td><td>73</td><td></td><td></td><td>16</td><td>15</td><td>14</td><td></td><td></td><td></td><td>7</td><td>6</td><td>5</td><td>4</td><td>3</td><td></td><td></td></tr> </table>																											59	58	57	56	55	53			50	49	48		46					39	38	37	36	35	34	33								29				23	22	21		18					73			16	15	14				7	6	5	4	3							
											59	58	57	56	55	53																																																																																		
		50	49	48		46					39	38	37	36	35	34	33																																																																																	
							29				23	22	21		18																																																																																			
		73			16	15	14				7	6	5	4	3																																																																																			
AVAILABLE	NOT APPLICABLE	34566-3403	SEE 34566-3003																																																																																															
AVAILABLE	NOT APPLICABLE	34566-3503	G	0	A	BLACK	<table border="1"> <tr><td>72</td><td>71</td><td>69</td><td>68</td><td>67</td><td>66</td><td>64</td><td>63</td><td>62</td><td>60</td><td>59</td><td></td><td></td><td></td><td></td><td></td><td></td><td></td><td></td></tr> <tr><td>52</td><td></td><td>49</td><td>48</td><td></td><td>46</td><td>44</td><td>43</td><td>42</td><td>40</td><td>39</td><td></td><td></td><td></td><td></td><td></td><td>35</td><td>34</td><td>33</td></tr> <tr><td></td><td></td><td></td><td>73</td><td>32</td><td></td><td>29</td><td></td><td>27</td><td></td><td>24</td><td>23</td><td></td><td></td><td></td><td></td><td></td><td></td><td></td></tr> <tr><td></td><td></td><td></td><td></td><td></td><td>14</td><td>13</td><td>12</td><td>11</td><td>9</td><td>8</td><td>7</td><td>6</td><td>5</td><td>4</td><td>3</td><td>2</td><td>1</td><td></td></tr> </table>																72	71	69	68	67	66	64	63	62	60	59									52		49	48		46	44	43	42	40	39						35	34	33				73	32		29		27		24	23													14	13	12	11	9	8	7	6	5	4	3	2	1	
72	71	69	68	67	66	64	63	62	60	59																																																																																								
52		49	48		46	44	43	42	40	39						35	34	33																																																																																
			73	32		29		27		24	23																																																																																							
					14	13	12	11	9	8	7	6	5	4	3	2	1																																																																																	

SEE NEXT PAGE FOR ADDITIONAL NUMBERS

ENTER DESCRIPTION EC NO: UAU2010-1551 DRAWN BY: 2010/03/15 CHKDGR: FFH APPR: VKOSHY DATE: 2010/03/18 F40	QUALITY SYMBOLS ▽=0 ▽=0	GENERAL TOLERANCES (UNLESS SPECIFIED) <table border="1"> <tr><th></th><th>mm</th><th>INCH</th></tr> <tr><td>4 PLACES</td><td>±---</td><td>±---</td></tr> <tr><td>3 PLACES</td><td>±---</td><td>±---</td></tr> <tr><td>2 PLACES</td><td>±---</td><td>±---</td></tr> <tr><td>1 PLACE</td><td>±---</td><td>±---</td></tr> </table>		mm	INCH	4 PLACES	±---	±---	3 PLACES	±---	±---	2 PLACES	±---	±---	1 PLACE	±---	±---	DIMENSION STYLE MM ONLY	SCALE 1:1	DESIGN UNITS METRIC	THIRD ANGLE PROJECTION
		mm	INCH																		
	4 PLACES	±---	±---																		
	3 PLACES	±---	±---																		
2 PLACES	±---	±---																			
1 PLACE	±---	±---																			
DESCRIPTION DRAWN BY: SRAJENDRANAT CHECKED BY: TSKIVER APPROVED BY: VKOSHY DATE: 2010/03/18	GENERAL TOLERANCES (UNLESS SPECIFIED) ANGULAR ±---°	DRAFT WHERE APPLICABLE MUST REMAIN WITHIN DIMENSIONS	DRAWN BY SRAJENDRANAT DATE 2008/05/09 CHECKED BY TSKIVER DATE 2008/05/09 APPROVED BY VKOSHY DATE 2010/03/18	SCALE 1:1 DESIGN UNITS METRIC	TITLE MX123 73/80 CKT HRNS CONN ASSY	MOLEX INCORPORATED															
MATERIAL NO. SEE BOM TABLE SIZE D	DOCUMENT NO. SD-34566-001	SHEET NO. 6 OF 36	THIS DRAWING CONTAINS INFORMATION THAT IS PROPRIETARY TO MOLEX INCORPORATED AND SHOULD NOT BE USED WITHOUT WRITTEN PERMISSION																		

19 18 17 16 15 14 13 12 11 10 9 8 7 6 5 4 3 2 1

STATUS	GM PART #	MATERIAL #	PART/MATERIAL REVISION	WIRE DRESS OPTION	KEY OPTION	COLOR (TPA)	NUMBERS INDICATE CAVITIES OPEN FOR CIRCUITS																																																																																												
AVAILABLE	NOT APPLICABLE	34566-7603	G	0	B	ST GRAY	<table border="1"> <tr><td></td><td></td><td>69</td><td>68</td><td>66</td><td></td><td></td><td></td><td></td><td></td><td></td><td></td><td></td><td></td><td>59</td><td>57</td><td>55</td><td>53</td></tr> <tr><td></td><td></td><td>49</td><td>48</td><td>46</td><td></td><td>44</td><td></td><td></td><td></td><td></td><td></td><td></td><td></td><td>39</td><td>37</td><td>35</td><td>33</td></tr> <tr><td colspan="2">73</td><td></td><td></td><td></td><td></td><td>29</td><td>28</td><td></td><td></td><td></td><td></td><td></td><td></td><td>23</td><td>21</td><td></td><td>18</td><td>17</td></tr> <tr><td></td><td></td><td></td><td></td><td></td><td></td><td>12</td><td>11</td><td>10</td><td></td><td></td><td></td><td></td><td></td><td>7</td><td></td><td></td><td></td><td></td></tr> </table>																		69	68	66										59	57	55	53			49	48	46		44								39	37	35	33	73						29	28							23	21		18	17							12	11	10						7							
		69	68	66										59	57	55	53																																																																																		
		49	48	46		44								39	37	35	33																																																																																		
73						29	28							23	21		18	17																																																																																	
						12	11	10						7																																																																																					
AVAILABLE	NOT APPLICABLE	34566-7703	G	0	A	BLACK	<table border="1"> <tr><td>72</td><td>71</td><td>70</td><td>69</td><td>68</td><td>67</td><td>66</td><td></td><td>64</td><td>63</td><td>62</td><td></td><td>60</td><td>59</td><td></td><td></td><td>55</td><td>54</td><td>53</td></tr> <tr><td>52</td><td></td><td>49</td><td>48</td><td></td><td></td><td></td><td></td><td>44</td><td>43</td><td>42</td><td></td><td>40</td><td>39</td><td></td><td></td><td>35</td><td>34</td><td>33</td></tr> <tr><td colspan="2">73</td><td></td><td></td><td>32</td><td></td><td>29</td><td>27</td><td></td><td></td><td></td><td></td><td>24</td><td>23</td><td></td><td></td><td>19</td><td>18</td><td>17</td></tr> <tr><td></td><td></td><td>16</td><td></td><td></td><td></td><td>13</td><td>12</td><td>11</td><td></td><td></td><td>9</td><td>8</td><td>7</td><td>6</td><td>5</td><td>4</td><td>3</td><td>2</td><td>1</td></tr> </table>																72	71	70	69	68	67	66		64	63	62		60	59			55	54	53	52		49	48					44	43	42		40	39			35	34	33	73				32		29	27					24	23			19	18	17			16				13	12	11			9	8	7	6	5	4	3	2	1
72	71	70	69	68	67	66		64	63	62		60	59			55	54	53																																																																																	
52		49	48					44	43	42		40	39			35	34	33																																																																																	
73				32		29	27					24	23			19	18	17																																																																																	
		16				13	12	11			9	8	7	6	5	4	3	2	1																																																																																
AVAILABLE	NOT APPLICABLE	34566-7803	G	0	A	BLACK	<table border="1"> <tr><td>72</td><td>71</td><td>70</td><td></td><td>68</td><td>66</td><td></td><td>64</td><td>63</td><td>62</td><td>61</td><td>60</td><td>59</td><td></td><td></td><td></td><td>55</td><td>54</td><td>53</td></tr> <tr><td>52</td><td></td><td>49</td><td>48</td><td></td><td>46</td><td></td><td>44</td><td>43</td><td>42</td><td></td><td>40</td><td>39</td><td></td><td></td><td></td><td>35</td><td>34</td><td>33</td></tr> <tr><td colspan="2">73</td><td></td><td></td><td>32</td><td></td><td>29</td><td>27</td><td></td><td></td><td></td><td>24</td><td>23</td><td></td><td></td><td>19</td><td>18</td><td>17</td></tr> <tr><td></td><td></td><td>16</td><td></td><td>14</td><td>13</td><td>12</td><td>11</td><td></td><td></td><td>9</td><td>8</td><td>7</td><td>6</td><td></td><td></td><td>3</td><td>2</td><td>1</td></tr> </table>																72	71	70		68	66		64	63	62	61	60	59				55	54	53	52		49	48		46		44	43	42		40	39				35	34	33	73				32		29	27				24	23			19	18	17			16		14	13	12	11			9	8	7	6			3	2	1		
72	71	70		68	66		64	63	62	61	60	59				55	54	53																																																																																	
52		49	48		46		44	43	42		40	39				35	34	33																																																																																	
73				32		29	27				24	23			19	18	17																																																																																		
		16		14	13	12	11			9	8	7	6			3	2	1																																																																																	
AVAILABLE	NOT APPLICABLE	34566-7903	G	0	B	ST GRAY	<table border="1"> <tr><td></td><td></td><td></td><td></td><td></td><td></td><td></td><td></td><td>64</td><td></td><td>61</td><td>59</td><td>57</td><td>55</td><td>53</td><td></td><td></td><td></td><td></td></tr> <tr><td></td><td></td><td></td><td></td><td></td><td></td><td></td><td></td><td></td><td></td><td>42</td><td></td><td>39</td><td></td><td>35</td><td>33</td><td></td><td></td><td></td></tr> <tr><td colspan="2">73</td><td></td><td></td><td></td><td></td><td></td><td></td><td></td><td></td><td></td><td></td><td>23</td><td></td><td>20</td><td>19</td><td>18</td><td>17</td></tr> <tr><td></td><td></td><td></td><td></td><td></td><td></td><td>15</td><td></td><td></td><td></td><td></td><td></td><td></td><td></td><td>4</td><td>3</td><td>2</td><td>1</td></tr> </table>																								64		61	59	57	55	53															42		39		35	33				73												23		20	19	18	17							15								4	3	2	1			
								64		61	59	57	55	53																																																																																					
										42		39		35	33																																																																																				
73												23		20	19	18	17																																																																																		
						15								4	3	2	1																																																																																		
AVAILABLE	NOT APPLICABLE	34566-8003	G	0	A	BLACK	<table border="1"> <tr><td></td><td></td><td>69</td><td>68</td><td></td><td></td><td>65</td><td>64</td><td>63</td><td></td><td>61</td><td>60</td><td>59</td><td>58</td><td>56</td><td></td><td></td><td></td><td></td></tr> <tr><td>52</td><td>50</td><td>49</td><td>48</td><td>47</td><td></td><td></td><td></td><td></td><td></td><td>41</td><td></td><td></td><td>38</td><td>37</td><td>36</td><td></td><td>34</td><td>33</td></tr> <tr><td colspan="2">73</td><td></td><td></td><td>32</td><td>31</td><td>30</td><td>29</td><td>28</td><td>27</td><td></td><td></td><td>24</td><td>23</td><td></td><td>20</td><td>19</td><td>18</td><td>17</td></tr> <tr><td></td><td></td><td>16</td><td></td><td></td><td></td><td>13</td><td>12</td><td>11</td><td>10</td><td>9</td><td></td><td></td><td></td><td></td><td></td><td></td><td></td><td>1</td></tr> </table>																		69	68			65	64	63		61	60	59	58	56					52	50	49	48	47						41			38	37	36		34	33	73				32	31	30	29	28	27			24	23		20	19	18	17			16				13	12	11	10	9								1	
		69	68			65	64	63		61	60	59	58	56																																																																																					
52	50	49	48	47						41			38	37	36		34	33																																																																																	
73				32	31	30	29	28	27			24	23		20	19	18	17																																																																																	
		16				13	12	11	10	9								1																																																																																	
AVAILABLE	NOT APPLICABLE	34566-8103	G	0	H	ST GRAY	<table border="1"> <tr><td></td><td>78</td><td></td><td></td><td></td><td></td><td></td><td>72</td><td>71</td><td>70</td><td>69</td><td>68</td><td></td><td>66</td><td>65</td><td>64</td><td>63</td><td>61</td><td></td></tr> <tr><td>60</td><td>59</td><td>58</td><td>57</td><td>56</td><td></td><td></td><td>53</td><td>52</td><td>50</td><td></td><td></td><td></td><td></td><td></td><td>44</td><td>43</td><td>41</td><td></td></tr> <tr><td>40</td><td></td><td></td><td>37</td><td></td><td>35</td><td>34</td><td>33</td><td>32</td><td>30</td><td>29</td><td></td><td>27</td><td>26</td><td>24</td><td></td><td>22</td><td>21</td><td></td></tr> <tr><td>20</td><td>19</td><td>18</td><td>17</td><td>16</td><td></td><td></td><td>13</td><td>12</td><td></td><td></td><td>8</td><td>6</td><td>5</td><td></td><td>3</td><td>2</td><td></td><td></td></tr> </table>																	78						72	71	70	69	68		66	65	64	63	61		60	59	58	57	56			53	52	50						44	43	41		40			37		35	34	33	32	30	29		27	26	24		22	21		20	19	18	17	16			13	12			8	6	5		3	2			
	78						72	71	70	69	68		66	65	64	63	61																																																																																		
60	59	58	57	56			53	52	50						44	43	41																																																																																		
40			37		35	34	33	32	30	29		27	26	24		22	21																																																																																		
20	19	18	17	16			13	12			8	6	5		3	2																																																																																			
AVAILABLE	NOT APPLICABLE	34566-8203	G	0	A	BLACK	<table border="1"> <tr><td></td><td>70</td><td></td><td>67</td><td>66</td><td></td><td></td><td></td><td></td><td></td><td></td><td></td><td></td><td>58</td><td>56</td><td>55</td><td>54</td><td></td><td></td></tr> <tr><td></td><td></td><td></td><td>47</td><td></td><td>44</td><td>43</td><td>42</td><td>41</td><td></td><td>39</td><td></td><td></td><td>37</td><td>36</td><td></td><td>34</td><td></td><td></td></tr> <tr><td colspan="2">73</td><td></td><td></td><td>31</td><td>30</td><td></td><td></td><td>27</td><td>25</td><td>24</td><td></td><td></td><td>21</td><td>20</td><td>19</td><td>18</td><td></td><td></td></tr> <tr><td></td><td></td><td></td><td></td><td></td><td></td><td>13</td><td></td><td></td><td></td><td></td><td></td><td></td><td>6</td><td>5</td><td>4</td><td>3</td><td>2</td><td>1</td></tr> </table>																	70		67	66									58	56	55	54						47		44	43	42	41		39			37	36		34			73				31	30			27	25	24			21	20	19	18									13							6	5	4	3	2	1	
	70		67	66									58	56	55	54																																																																																			
			47		44	43	42	41		39			37	36		34																																																																																			
73				31	30			27	25	24			21	20	19	18																																																																																			
						13							6	5	4	3	2	1																																																																																	
AVAILABLE	NOT APPLICABLE	34566-8303	G	0	A	BLACK	<table border="1"> <tr><td>72</td><td>71</td><td>69</td><td>68</td><td>67</td><td>66</td><td></td><td>64</td><td>63</td><td>62</td><td></td><td>59</td><td>58</td><td>57</td><td>56</td><td></td><td>54</td><td>53</td></tr> <tr><td>52</td><td>51</td><td>50</td><td>49</td><td>48</td><td>47</td><td>46</td><td></td><td>44</td><td>43</td><td>42</td><td></td><td>39</td><td>38</td><td>37</td><td>36</td><td>35</td><td>34</td><td>33</td></tr> <tr><td colspan="2">73</td><td></td><td></td><td>32</td><td>31</td><td>30</td><td>29</td><td></td><td>27</td><td></td><td>24</td><td>23</td><td>22</td><td>21</td><td>20</td><td>19</td><td>18</td><td>17</td></tr> <tr><td></td><td></td><td></td><td></td><td>15</td><td>14</td><td>13</td><td>12</td><td>11</td><td></td><td>9</td><td>8</td><td>7</td><td>6</td><td>5</td><td>4</td><td>3</td><td>2</td><td>1</td></tr> </table>																72	71	69	68	67	66		64	63	62		59	58	57	56		54	53	52	51	50	49	48	47	46		44	43	42		39	38	37	36	35	34	33	73				32	31	30	29		27		24	23	22	21	20	19	18	17					15	14	13	12	11		9	8	7	6	5	4	3	2	1		
72	71	69	68	67	66		64	63	62		59	58	57	56		54	53																																																																																		
52	51	50	49	48	47	46		44	43	42		39	38	37	36	35	34	33																																																																																	
73				32	31	30	29		27		24	23	22	21	20	19	18	17																																																																																	
				15	14	13	12	11		9	8	7	6	5	4	3	2	1																																																																																	

SEE NEXT PAGE FOR ADDITIONAL NUMBERS

ENTER DESCRIPTION EC NO: UAU2010-1551 DRAWN BY: DRWNAH01 CHECKED BY: CHKDRFF1HS APPROVED BY: APPR.VKOSHY DATE: 2010/03/15 DATE: 2008/05/09 DATE: 2010/03/18 REV: F40	QUALITY SYMBOLS ▽=0 ▽=0	GENERAL TOLERANCES (UNLESS SPECIFIED) <table border="1"> <tr><th></th><th>mm</th><th>INCH</th></tr> <tr><td>4 PLACES</td><td>±---</td><td>±---</td></tr> <tr><td>3 PLACES</td><td>±---</td><td>±---</td></tr> <tr><td>2 PLACES</td><td>±---</td><td>±---</td></tr> <tr><td>1 PLACE</td><td>±---</td><td>±---</td></tr> </table> ANGULAR ±---°		mm	INCH	4 PLACES	±---	±---	3 PLACES	±---	±---	2 PLACES	±---	±---	1 PLACE	±---	±---	DIMENSION STYLE MM ONLY	SCALE 1:1	DESIGN UNITS METRIC	THIRD ANGLE PROJECTION
		mm	INCH																		
	4 PLACES	±---	±---																		
	3 PLACES	±---	±---																		
2 PLACES	±---	±---																			
1 PLACE	±---	±---																			
DRAWN BY: SRAJENDRANAT CHECKED BY: TSKIVER APPROVED BY: VKOSHY DATE: 2008/05/09 DATE: 2010/03/18	DATE: 2008/05/09	DATE: 2010/03/18	TITLE MX123 73/80 CKT HRNS CONN ASSY	MOLEX INCORPORATED	DOCUMENT NO. SD-34566-001	SHEET NO. 12 OF 36															
DRAFT WHERE APPLICABLE MUST REMAIN WITHIN DIMENSIONS			SEE BOM TABLE	THIS DRAWING CONTAINS INFORMATION THAT IS PROPRIETARY TO MOLEX INCORPORATED AND SHOULD NOT BE USED WITHOUT WRITTEN PERMISSION																	
MOLEX INCORPORATED																					

20 19 18 17 16 15 14 13 12 11 10 9 8 7 6 5 4 3 2 1

STATUS	GM PART #	MATERIAL #	PART/MATERIAL REVISION	WIRE DRESS OPTION	KEY OPTION	COLOR (TPA)	NUMBERS INDICATE CAVITIES OPEN FOR CIRCUITS																																																																																																																																						
AVAILABLE	NOT APPLICABLE	34566-1013	G	0	A	BLACK	<table border="1"> <tr><td>71</td><td>69</td><td>68</td><td></td><td>65</td><td>64</td><td>63</td><td>61</td><td>59</td><td>58</td><td>57</td><td>56</td><td></td><td></td><td></td><td></td><td></td><td></td><td></td><td></td></tr> <tr><td>52</td><td>50</td><td>49</td><td>47</td><td></td><td></td><td></td><td>41</td><td></td><td></td><td></td><td></td><td></td><td></td><td></td><td></td><td></td><td></td><td></td><td></td></tr> <tr><td></td><td></td><td></td><td>32</td><td>31</td><td>30</td><td>29</td><td>28</td><td>27</td><td></td><td>24</td><td>23</td><td></td><td></td><td></td><td></td><td></td><td></td><td></td><td></td></tr> <tr><td></td><td></td><td></td><td>16</td><td></td><td></td><td></td><td>13</td><td>12</td><td>11</td><td>10</td><td>9</td><td></td><td></td><td></td><td></td><td></td><td></td><td>3</td><td>2</td><td>1</td></tr> </table>																71	69	68		65	64	63	61	59	58	57	56									52	50	49	47				41																32	31	30	29	28	27		24	23												16				13	12	11	10	9							3	2	1																																						
71	69	68		65	64	63	61	59	58	57	56																																																																																																																																		
52	50	49	47				41																																																																																																																																						
			32	31	30	29	28	27		24	23																																																																																																																																		
			16				13	12	11	10	9							3	2	1																																																																																																																									
AVAILABLE	NOT APPLICABLE	34566-1023	G	0	A	BLACK	<table border="1"> <tr><td></td><td>70</td><td></td><td>67</td><td>66</td><td>65</td><td></td><td></td><td></td><td></td><td></td><td></td><td></td><td></td><td></td><td></td><td></td><td>58</td><td>57</td><td>55</td><td>54</td></tr> <tr><td></td><td>50</td><td>49</td><td>47</td><td></td><td></td><td>44</td><td>43</td><td>42</td><td>41</td><td>39</td><td>37</td><td>35</td><td></td><td></td><td></td><td></td><td></td><td></td><td></td><td></td></tr> <tr><td></td><td></td><td></td><td>32</td><td>30</td><td></td><td></td><td>27</td><td>25</td><td>24</td><td></td><td></td><td></td><td></td><td></td><td></td><td></td><td>21</td><td>20</td><td>19</td><td>18</td><td>17</td></tr> <tr><td></td><td></td><td></td><td>16</td><td>15</td><td>13</td><td></td><td></td><td></td><td></td><td>10</td><td>9</td><td>8</td><td></td><td></td><td></td><td></td><td>6</td><td>5</td><td></td><td>3</td><td>2</td><td>1</td></tr> </table>																	70		67	66	65												58	57	55	54		50	49	47			44	43	42	41	39	37	35												32	30			27	25	24								21	20	19	18	17				16	15	13					10	9	8					6	5		3	2	1																																
	70		67	66	65												58	57	55	54																																																																																																																									
	50	49	47			44	43	42	41	39	37	35																																																																																																																																	
			32	30			27	25	24								21	20	19	18	17																																																																																																																								
			16	15	13					10	9	8					6	5		3	2	1																																																																																																																							
AVAILABLE	NOT APPLICABLE	34566-1033	G	0	A	BLACK	<table border="1"> <tr><td>72</td><td>70</td><td></td><td>67</td><td>66</td><td>65</td><td></td><td></td><td></td><td></td><td></td><td></td><td></td><td></td><td></td><td></td><td></td><td>58</td><td>57</td><td>55</td><td>54</td></tr> <tr><td></td><td>50</td><td>49</td><td>47</td><td></td><td></td><td>44</td><td>43</td><td>42</td><td>41</td><td>39</td><td>37</td><td>35</td><td></td><td></td><td></td><td></td><td></td><td></td><td></td><td></td><td></td></tr> <tr><td></td><td></td><td></td><td>32</td><td>30</td><td></td><td></td><td>27</td><td>26</td><td>25</td><td>24</td><td></td><td></td><td></td><td></td><td></td><td></td><td>21</td><td>20</td><td>19</td><td>18</td><td>17</td></tr> <tr><td></td><td></td><td></td><td>16</td><td>15</td><td>13</td><td></td><td></td><td></td><td></td><td>10</td><td>9</td><td>8</td><td></td><td></td><td></td><td></td><td>6</td><td>5</td><td></td><td>3</td><td>2</td><td>1</td></tr> </table>																72	70		67	66	65												58	57	55	54		50	49	47			44	43	42	41	39	37	35													32	30			27	26	25	24							21	20	19	18	17				16	15	13					10	9	8					6	5		3	2	1																															
72	70		67	66	65												58	57	55	54																																																																																																																									
	50	49	47			44	43	42	41	39	37	35																																																																																																																																	
			32	30			27	26	25	24							21	20	19	18	17																																																																																																																								
			16	15	13					10	9	8					6	5		3	2	1																																																																																																																							
AVAILABLE	NOT APPLICABLE	34566-1043	G	0	B	ST GRAY	<table border="1"> <tr><td></td><td>71</td><td>70</td><td>68</td><td>66</td><td>65</td><td></td><td></td><td></td><td></td><td></td><td></td><td></td><td></td><td></td><td></td><td></td><td>59</td><td>58</td><td>57</td><td></td><td>54</td><td>53</td></tr> <tr><td></td><td>51</td><td>50</td><td>49</td><td>48</td><td>46</td><td>45</td><td>43</td><td>41</td><td>40</td><td>39</td><td>38</td><td>37</td><td>36</td><td>35</td><td>33</td><td></td><td></td><td></td><td></td><td></td><td></td><td></td></tr> <tr><td></td><td></td><td></td><td>32</td><td>31</td><td>30</td><td></td><td></td><td></td><td></td><td></td><td></td><td></td><td></td><td></td><td></td><td></td><td></td><td></td><td></td><td></td><td></td><td></td></tr> <tr><td></td><td></td><td></td><td>16</td><td></td><td></td><td></td><td>13</td><td>12</td><td>11</td><td>10</td><td>9</td><td>8</td><td>7</td><td>6</td><td>5</td><td>4</td><td></td><td></td><td></td><td></td><td></td><td></td></tr> </table>																	71	70	68	66	65												59	58	57		54	53		51	50	49	48	46	45	43	41	40	39	38	37	36	35	33											32	31	30																					16				13	12	11	10	9	8	7	6	5	4																																	
	71	70	68	66	65												59	58	57		54	53																																																																																																																							
	51	50	49	48	46	45	43	41	40	39	38	37	36	35	33																																																																																																																														
			32	31	30																																																																																																																																								
			16				13	12	11	10	9	8	7	6	5	4																																																																																																																													
AVAILABLE	NOT APPLICABLE	34566-1053	G	0	H	ST GRAY	<table border="1"> <tr><td></td><td>79</td><td>78</td><td>77</td><td>76</td><td>75</td><td>74</td><td>73</td><td>72</td><td>71</td><td>70</td><td>69</td><td>68</td><td></td><td></td><td></td><td></td><td>66</td><td>65</td><td>64</td><td>63</td><td>61</td></tr> <tr><td>60</td><td>59</td><td>58</td><td>57</td><td>56</td><td></td><td></td><td></td><td></td><td></td><td>53</td><td>52</td><td>50</td><td></td><td></td><td></td><td></td><td></td><td></td><td></td><td></td><td></td><td>41</td></tr> <tr><td>40</td><td>39</td><td>38</td><td>37</td><td></td><td>35</td><td>34</td><td>33</td><td>32</td><td></td><td>30</td><td>29</td><td></td><td></td><td></td><td></td><td></td><td>27</td><td>26</td><td></td><td></td><td></td><td>22</td><td>21</td></tr> <tr><td>20</td><td>19</td><td>18</td><td>17</td><td>16</td><td></td><td></td><td>14</td><td>13</td><td>12</td><td>11</td><td></td><td></td><td></td><td></td><td></td><td></td><td>9</td><td>8</td><td></td><td></td><td></td><td></td><td></td></tr> </table>																	79	78	77	76	75	74	73	72	71	70	69	68					66	65	64	63	61	60	59	58	57	56						53	52	50										41	40	39	38	37		35	34	33	32		30	29						27	26				22	21	20	19	18	17	16			14	13	12	11							9	8																															
	79	78	77	76	75	74	73	72	71	70	69	68					66	65	64	63	61																																																																																																																								
60	59	58	57	56						53	52	50										41																																																																																																																							
40	39	38	37		35	34	33	32		30	29						27	26				22	21																																																																																																																						
20	19	18	17	16			14	13	12	11							9	8																																																																																																																											
AVAILABLE	NOT APPLICABLE	34566-1063	G	0	B	ST GRAY	<table border="1"> <tr><td></td><td></td><td></td><td></td><td></td><td></td><td></td><td></td><td></td><td></td><td></td><td></td><td></td><td></td><td></td><td></td><td></td><td>60</td><td>59</td><td>57</td><td>56</td><td>55</td><td>53</td></tr> <tr><td></td><td></td><td></td><td>49</td><td>48</td><td>47</td><td></td><td></td><td></td><td></td><td></td><td></td><td></td><td></td><td></td><td></td><td></td><td></td><td>40</td><td>39</td><td>37</td><td>36</td><td>35</td><td>33</td></tr> <tr><td></td><td></td><td></td><td></td><td></td><td></td><td></td><td></td><td></td><td></td><td></td><td></td><td></td><td></td><td></td><td></td><td></td><td></td><td></td><td></td><td></td><td></td><td></td><td></td></tr> <tr><td></td><td></td><td></td><td></td><td></td><td></td><td></td><td></td><td></td><td></td><td></td><td></td><td></td><td></td><td></td><td></td><td></td><td></td><td>24</td><td>23</td><td>22</td><td></td><td></td><td></td></tr> <tr><td></td><td></td><td></td><td></td><td></td><td></td><td></td><td></td><td></td><td></td><td></td><td></td><td></td><td></td><td></td><td></td><td></td><td></td><td></td><td></td><td></td><td></td><td></td><td>2</td></tr> </table>																																	60	59	57	56	55	53				49	48	47													40	39	37	36	35	33																																											24	23	22																											2
																	60	59	57	56	55	53																																																																																																																							
			49	48	47													40	39	37	36	35	33																																																																																																																						
																		24	23	22																																																																																																																									
																							2																																																																																																																						
AVAILABLE	NOT APPLICABLE	34566-1073	G	0	A	BLACK	<table border="1"> <tr><td>72</td><td>71</td><td>70</td><td>69</td><td>68</td><td>67</td><td>66</td><td>65</td><td>64</td><td>63</td><td>61</td><td>59</td><td>58</td><td>57</td><td>56</td><td></td><td></td><td></td><td></td><td></td><td></td><td></td><td></td></tr> <tr><td></td><td>50</td><td>49</td><td>48</td><td>47</td><td></td><td></td><td></td><td></td><td></td><td>42</td><td>41</td><td></td><td></td><td></td><td></td><td></td><td></td><td></td><td></td><td></td><td></td><td></td><td></td></tr> <tr><td></td><td></td><td></td><td>32</td><td>31</td><td>30</td><td>29</td><td>28</td><td>27</td><td>26</td><td></td><td>24</td><td>23</td><td></td><td></td><td></td><td></td><td></td><td></td><td></td><td></td><td></td><td></td></tr> <tr><td></td><td></td><td></td><td>16</td><td></td><td></td><td></td><td></td><td></td><td></td><td>13</td><td>12</td><td>11</td><td>10</td><td>9</td><td></td><td></td><td></td><td></td><td></td><td></td><td></td><td></td><td></td></tr> </table>																72	71	70	69	68	67	66	65	64	63	61	59	58	57	56										50	49	48	47						42	41																32	31	30	29	28	27	26		24	23														16							13	12	11	10	9																																		
72	71	70	69	68	67	66	65	64	63	61	59	58	57	56																																																																																																																															
	50	49	48	47						42	41																																																																																																																																		
			32	31	30	29	28	27	26		24	23																																																																																																																																	
			16							13	12	11	10	9																																																																																																																															
AVAILABLE	NOT APPLICABLE	34566-1083	G	0	B	ST GRAY	<table border="1"> <tr><td></td><td></td><td></td><td></td><td>68</td><td>67</td><td>66</td><td>65</td><td>64</td><td></td><td></td><td></td><td></td><td></td><td></td><td></td><td></td><td>59</td><td>58</td><td>57</td><td>55</td><td>54</td><td>53</td></tr> <tr><td></td><td>51</td><td>50</td><td>49</td><td>48</td><td>46</td><td>45</td><td>43</td><td>42</td><td>41</td><td>40</td><td>39</td><td>38</td><td>37</td><td>35</td><td>33</td><td></td><td></td><td></td><td></td><td></td><td></td><td></td></tr> <tr><td></td><td></td><td></td><td></td><td>32</td><td>31</td><td>30</td><td></td><td></td><td></td><td>26</td><td>24</td><td>23</td><td>22</td><td></td><td></td><td></td><td></td><td></td><td></td><td></td><td></td><td></td></tr> <tr><td></td><td></td><td></td><td></td><td>16</td><td></td><td></td><td></td><td></td><td></td><td>10</td><td>9</td><td>8</td><td>7</td><td>6</td><td>5</td><td>4</td><td>3</td><td>2</td><td>1</td><td></td><td></td><td></td></tr> </table>																				68	67	66	65	64									59	58	57	55	54	53		51	50	49	48	46	45	43	42	41	40	39	38	37	35	33												32	31	30				26	24	23	22														16						10	9	8	7	6	5	4	3	2	1																														
				68	67	66	65	64									59	58	57	55	54	53																																																																																																																							
	51	50	49	48	46	45	43	42	41	40	39	38	37	35	33																																																																																																																														
				32	31	30				26	24	23	22																																																																																																																																
				16						10	9	8	7	6	5	4	3	2	1																																																																																																																										

SEE NEXT PAGE FOR ADDITIONAL NUMBERS

ENTER DESCRIPTION EC NO: UAU2010-1551 DRAWN BY: DRWNAH01 CHECKED BY: CHKODRFFH APPROVED BY: APPR.VKOSHY DATE: 2010/03/15 DATE: 2008/05/09 DATE: 2010/03/18 F40	QUALITY SYMBOLS ▽=0 ▽=0	GENERAL TOLERANCES (UNLESS SPECIFIED) <table border="1"> <tr><th></th><th>mm</th><th>INCH</th></tr> <tr><td>4 PLACES</td><td>±---</td><td>±---</td></tr> <tr><td>3 PLACES</td><td>±---</td><td>±---</td></tr> <tr><td>2 PLACES</td><td>±---</td><td>±---</td></tr> <tr><td>1 PLACE</td><td>±---</td><td>±---</td></tr> </table>		mm	INCH	4 PLACES	±---	±---	3 PLACES	±---	±---	2 PLACES	±---	±---	1 PLACE	±---	±---	DIMENSION STYLE MM ONLY	SCALE 1:1	DESIGN UNITS METRIC	THIRD ANGLE PROJECTION
		mm	INCH																		
	4 PLACES	±---	±---																		
	3 PLACES	±---	±---																		
2 PLACES	±---	±---																			
1 PLACE	±---	±---																			
DRAFT WHERE APPLICABLE MUST REMAIN WITHIN DIMENSIONS	SEE BOM TABLE	MOLEX INCORPORATED	SD-34566-001	15 OF 36																	
THIS DRAWING CONTAINS INFORMATION THAT IS PROPRIETARY TO MOLEX INCORPORATED AND SHOULD NOT BE USED WITHOUT WRITTEN PERMISSION																					

20 19 18 17 16 15 14 13 12 11 10 9 8 7 6 5 4 3 2 1

STATUS	GM PART #	MATERIAL #	PART/MATERIAL REVISION	WIRE DRESS OPTION	KEY OPTION	COLOR (TPA)	NUMBERS INDICATE CAVITIES OPEN FOR CIRCUITS																		
AVAILABLE	NOT APPLICABLE	34566-1193	G	0	A	BLACK	72	71	69	68	67	66	64	63	62	60	59					54	53		
							52		49	48	46	44	43	42		39						34	33		
							73		32		29	27			23							17			
											14	13	12	11	9	8	7	6	5	4	3	2	1		
AVAILABLE	NOT APPLICABLE	34566-1213	G	0	A	BLACK	72	71	69	68	67	66	64	63	62		59					54	53		
							52		48	46	44	43	42		39							34	33		
							73		32		29	27			24	23						17			
											14	13	12	11	9	8			5	4	3	2	1		
AVAILABLE	NOT APPLICABLE	34566-1223	G	0	B	ST GRY				67	66	65	63	62		59	57	55				53			
										48			43	42		39	37	35				33			
							73					29	27	26		23	21					17			
												12			9	7									
AVAILABLE	NOT APPLICABLE	34566-1233	G	0	B	ST GRY				48	46		42		39	37	35					33			
							73				29		26		23	21						17			
												12			9	7									
AVAILABLE	NOT APPLICABLE	34566-1243	G	0	B	ST GRY			50	48	46					59	57	55				53			
							73								40	39	37	35				33			
															23	21						17			
										15		12				7	6	5	4	3					
AVAILABLE	NOT APPLICABLE	34566-1253	G	9	B	ST GRY			49	48		65			60	59	57	55				53			
							73				46				40	39	37	35				33			
															24	23	21					2			
AVAILABLE	NOT APPLICABLE	34566-1263	G	9	A	BLACK	72	71	69	68	67	66	64	63	62		59				56		53		
							50		48	46		44	43	42		39					36	35	33		
							73		32	30	29	27			24	23					20		17		
											14	13	12	11	9	8					5	4	3	2	1
AVAILABLE	NOT APPLICABLE	34566-1273	G	0	A	BLACK		70	69	68		65	64	63		61	59	58	57	56					
							52	50	49	48	47					41		38	37	36		34	33		
							73		32	31	30	29	28	27		24	23				20	19	18		
										16		13	12	11	10	9							1		

ENTER DESCRIPTION EC NO: UAU2010-1551 DRAWN BY: 2010/03/15 CHECKED BY: 2008/05/09 APPROVED BY: 2010/03/18 T40	QUALITY SYMBOLS ▽=0 ▽=0	GENERAL TOLERANCES (UNLESS SPECIFIED) <table border="1"> <tr> <th></th> <th>mm</th> <th>INCH</th> </tr> <tr> <td>4 PLACES</td> <td>±---</td> <td>±---</td> </tr> <tr> <td>3 PLACES</td> <td>±---</td> <td>±---</td> </tr> <tr> <td>2 PLACES</td> <td>±---</td> <td>±---</td> </tr> <tr> <td>1 PLACE</td> <td>±---</td> <td>±---</td> </tr> </table>		mm	INCH	4 PLACES	±---	±---	3 PLACES	±---	±---	2 PLACES	±---	±---	1 PLACE	±---	±---	DIMENSION STYLE MM ONLY	SCALE 1:1	DESIGN UNITS METRIC	THIRD ANGLE PROJECTION
		mm	INCH																		
	4 PLACES	±---	±---																		
	3 PLACES	±---	±---																		
2 PLACES	±---	±---																			
1 PLACE	±---	±---																			
DESCRIPTION MX123 73/80 CKT HRNS CONN ASSY	DRAWN BY SRAJENDRANAT 2008/05/09	DATE 2008/05/09	TITLE MX123 73/80 CKT HRNS CONN ASSY	APPROVED BY VKOSHY 2010/03/18	DATE 2010/03/18	MATERIAL NO. SEE BOM TABLE															
REVISION T40	DRAFT WHERE APPLICABLE MUST REMAIN WITHIN DIMENSIONS	MOLEX INCORPORATED	DOCUMENT NO. SD-34566-001	SHEET NO. 17 OF 36	THIS DRAWING CONTAINS INFORMATION THAT IS PROPRIETARY TO MOLEX INCORPORATED AND SHOULD NOT BE USED WITHOUT WRITTEN PERMISSION																

19 18 17 16 15 14 13 12 11 10 9 8 7 6 5 4 3 2 1

20 19 18 17 16 15 14 13 12 11 10 9 8 7 6 5 4 3 2 1

STATUS	GM PART #	MATERIAL #	PART/MATERIAL REVISION	WIRE DRESS OPTION	KEY OPTION	COLOR (TPA)	NUMBERS INDICATE CAVITIES OPEN FOR CIRCUITS																			
AVAILABLE	NOT APPLICABLE	34566-1473	G	0	A	BLACK	72	71	69	68	67	66	64	63	62	59									54	53
							52		49	48	46	44	43	42	39									34	33	
							73			32		29	27		24	23									17	
											14	13	12	11	9	8	7	6	5	4	3	2	1			
AVAILABLE	NOT APPLICABLE	34566-1483	G	0	A	BLACK	72	71	69	68		65	64	63	61	59	58		56					34	33	
							52	50	49		47				41		38	37	36					18	17	
							73			32	31	30	29	28	27		24	23					20	19	18	17
										16			13	12	11	10	9								1	
AVAILABLE	NOT APPLICABLE	34566-1493	G	0	B	ST GRY				68							59	58	57			55		53		
									49	48		46					39	38	37			35		33		
							73					29					23	22	21				18	17		
												12	11	10		7								1		
AVAILABLE	NOT APPLICABLE	34566-1513	G	0	B	ST GRY						65					59		57			55		53		
									49	48		46					39		37			35		33		
							73					29					23		21				17			
												12				7								1		
AVAILABLE	NOT APPLICABLE	34566-1523	G	0	A	BLACK		70	69	68		65	64			59	58		56				54			
							52	50	49		47				42	41		38	37	36			34			
							73			32	31	30	29	28	27	26		23				20	19	18	17	
										16			13	12	11	10	9	8						1		
AVAILABLE	NOT APPLICABLE	34566-1533	G	0	A	BLACK	72	71	70	69	68		65	64	63	61	59	58	57	56				34	33	
							52	51	50	49		47				41		38	37	36				18	17	
							73			32	31	30	29	28	27		24	23					20	19	18	17
										16			13	12	11	10	9					3	2	1		
AVAILABLE	NOT APPLICABLE	34566-1543	G	0	B	ST GRY				69	68	66					59		57			55		53		
									49	48		46					39		37			35		33		
							73					29					23		21							
														11	10		7									
AVAILABLE	NOT APPLICABLE	34566-1583	G	0	A	BLACK		70		67	66	65			61			58	57			55	54			
									49		47	45	44	43	42	41	39		37			34				
							73			32		30		27	25	24			21	20	19	18	17			
											15	13		11		9	8		6	5		3	2	1		

ENTER DESCRIPTION EC NO: UAU2010-1551 DRAWN BY: DRWNAH01 CHECKED BY: CHKDGRFFH APPROVED BY: APPR.VKOSHY DATE: 2010/03/15 DATE: 2008/05/09 DATE: 2010/03/18	QUALITY SYMBOLS ▽=0 ▽=0	GENERAL TOLERANCES (UNLESS SPECIFIED) <table border="1"> <tr> <th></th> <th>mm</th> <th>INCH</th> </tr> <tr> <td>4 PLACES</td> <td>±---</td> <td>±---</td> </tr> <tr> <td>3 PLACES</td> <td>±---</td> <td>±---</td> </tr> <tr> <td>2 PLACES</td> <td>±---</td> <td>±---</td> </tr> <tr> <td>1 PLACE</td> <td>±---</td> <td>±---</td> </tr> </table>		mm	INCH	4 PLACES	±---	±---	3 PLACES	±---	±---	2 PLACES	±---	±---	1 PLACE	±---	±---	DIMENSION STYLE MM ONLY	SCALE 1:1	DESIGN UNITS METRIC	THIRD ANGLE PROJECTION
		mm	INCH																		
	4 PLACES	±---	±---																		
	3 PLACES	±---	±---																		
2 PLACES	±---	±---																			
1 PLACE	±---	±---																			
DESCRIPTION F40	DRAFT WHERE APPLICABLE MUST REMAIN WITHIN DIMENSIONS	DRAWN BY SRAJENDRANAT DATE 2008/05/09	CHECKED BY TSKIVER DATE 2008/05/09	APPROVED BY VKOSHY DATE 2010/03/18	TITLE MX123 73/80 CKT HRNS CONN ASSY	MOLEX INCORPORATED															
MATERIAL NO. SEE BOM TABLE	DOCUMENT NO. SD-34566-001	SHEET NO. 20 OF 36	THIS DRAWING CONTAINS INFORMATION THAT IS PROPRIETARY TO MOLEX INCORPORATED AND SHOULD NOT BE USED WITHOUT WRITTEN PERMISSION																		

19 18 17 16 15 14 13 12 11 10 9 8 7 6 5 4 3 2 1

20 19 18 17 16 15 14 13 12 11 10 9 8 7 6 5 4 3 2 1

STATUS	GM PART #	MATERIAL #	PART/MATERIAL REVISION	WIRE DRESS OPTION	KEY OPTION	COLOR (TPA)	NUMBERS INDICATE CAVITIES OPEN FOR CIRCUITS																
AVAILABLE	NOT APPLICABLE	34566-1773	G	0	C	BLUE	72	70		67	66		63	62		59	57					53	
							52	51			46	44		42	40	39						34	33
									73			30		27	26	25		22	21	20			
											15	14			10	9		6	5	4			
AVAILABLE	NOT APPLICABLE	34566-1783	G	0	C	BLUE	72	70		67	66		63	62		59	57					53	
							52	51			46	44		42	40	39						34	33
									73			30		26	25		22	21	20				
											15	14			10	9		6	5	4			
AVAILABLE	NOT APPLICABLE	34566-1793	G	0	A	BLACK			69				63	62	61		58	57	56	55	54	53	
							52	51	49				44	43	42	41			37	36	35	34	33
										73		32		29	28	27	26					19	18
											16		13	12	11	10						3	
AVAILABLE	NOT APPLICABLE	34566-1813	G	0	B	ST GRAY	72	71	70	68	67	66		62	61	60	59	58	57	56	55	54	53
							52	51	50	48	47	46		42	41	40	39	38	37	36	35	34	33
									73				32	31	30	29	28	27	26	25	24	23	
											16	15	14	13		10	9	8					
AVAILABLE	NOT APPLICABLE	34566-1823	G	0	A	BLACK	72	71	70	69	68	66	65	64		61	59	58	56	55	54	53	
							52	51	50	49	47			42	41			38	37	36	35	34	33
									73		32	31	30	29	28	27	26	24	23	22	21	20	19
											16		13	12	11	10	9	8				1	
AVAILABLE	NOT APPLICABLE	34566-1833	G	0	A	BLACK				68		65	63	61	59	58	56	55	54	53			
							52	51	50		47			41			38	37	36	35	34	33	
									73		32	31	30	29	28	27	25	24	23			20	19
											16		13	12	11	10						17	
AVAILABLE	NOT APPLICABLE	34566-1843	G	0	A	BLACK				68		65	63	61	59	58	56	55	54	53			
							52	51	50		47			41			38	37	36	35	34	33	
									73		32	31	30	29	28	27	24	23	22	21	20	19	18
											16	15	14	13	12	11	10					1	
AVAILABLE	NOT APPLICABLE	34566-1853	G	0	A	BLACK	72	71	70	69	68	67	65	63	61	60		57	56	55	54	53	
							52	51	50	49	48	47		44	43	41	40		37	36	35	34	33
									73				30	29	28		25	24		21	20	19	18
											16	15			11	10	9	8	7	6	5	4	3
AVAILABLE	NOT APPLICABLE	34566-1863	G	0	B	ST GRAY				68	67	66	65	64	63								
											46	45	43										
											32	30	29	28	27								17
											16				10								

ENTER DESCRIPTION EC NO: UAU2010-1551 DRAWN BY: DRWNAH01 CHECKED BY: CHKDRFF1 APPROVED BY: APPR.VKOSHY DATE: 2010/03/15 DATE: 2008/05/09 DATE: 2010/03/18	QUALITY SYMBOLS ▽=0 ▽=0	GENERAL TOLERANCES (UNLESS SPECIFIED) <table border="1"> <tr> <th></th> <th>mm</th> <th>INCH</th> </tr> <tr> <td>4 PLACES ±</td> <td>---</td> <td>---</td> </tr> <tr> <td>3 PLACES ±</td> <td>---</td> <td>---</td> </tr> <tr> <td>2 PLACES ±</td> <td>---</td> <td>---</td> </tr> <tr> <td>1 PLACE ±</td> <td>---</td> <td>---</td> </tr> </table>		mm	INCH	4 PLACES ±	---	---	3 PLACES ±	---	---	2 PLACES ±	---	---	1 PLACE ±	---	---	DIMENSION STYLE MM ONLY	SCALE 1:1	DESIGN UNITS METRIC	THIRD ANGLE PROJECTION
		mm	INCH																		
	4 PLACES ±	---	---																		
	3 PLACES ±	---	---																		
2 PLACES ±	---	---																			
1 PLACE ±	---	---																			
DESCRIPTION 73	DRAFT WHERE APPLICABLE MUST REMAIN WITHIN DIMENSIONS	SEE BOM TABLE	MATERIAL NO. SD-34566-001	DOCUMENT NO. SD-34566-001	SHEET NO. 23 OF 36	TITLE MX123 73/80 CKT HRNS CONN ASSY															
MOLEX INCORPORATED	MOLEX INCORPORATED	MOLEX INCORPORATED	MOLEX INCORPORATED	MOLEX INCORPORATED	MOLEX INCORPORATED	MOLEX INCORPORATED															
THIS DRAWING CONTAINS INFORMATION THAT IS PROPRIETARY TO MOLEX INCORPORATED AND SHOULD NOT BE USED WITHOUT WRITTEN PERMISSION																					

19 18 17 16 15 14 13 12 11 10 9 8 7 6 5 4 3 2 1

20	19	18	17	16	15	14	13	12	11	10	9	8	7	6	5	4	3	2	1																																																																																					
										STATUS	GM PART #	MATERIAL #	PART/MATERIAL REVISION	WIRE DRESS OPTION	KEY OPTION	COLOR (TPA)	NUMBERS INDICATE CAVITIES OPEN FOR CIRCUITS																																																																																							
										AVAILABLE	NOT APPLICABLE	34566-1873	G	0	C	BLUE	<table border="1"> <tr><td>72</td><td>70</td><td></td><td>67</td><td>66</td><td></td><td>63</td><td>62</td><td></td><td>59</td><td>57</td><td></td><td></td><td></td><td></td><td></td><td></td><td></td><td></td><td>53</td></tr> <tr><td>52</td><td>51</td><td></td><td></td><td>46</td><td></td><td>44</td><td>42</td><td></td><td>40</td><td>39</td><td></td><td></td><td></td><td></td><td></td><td></td><td></td><td></td><td>34</td><td>33</td></tr> <tr><td colspan="2">73</td><td></td><td>32</td><td>30</td><td></td><td>27</td><td>26</td><td>25</td><td></td><td>22</td><td>21</td><td>20</td><td></td><td></td><td></td><td></td><td></td><td></td><td></td></tr> <tr><td colspan="2"></td><td></td><td>15</td><td>14</td><td></td><td></td><td>10</td><td>9</td><td></td><td>6</td><td>5</td><td>4</td><td></td><td></td><td></td><td></td><td></td><td></td><td></td></tr> </table>	72	70		67	66		63	62		59	57									53	52	51			46		44	42		40	39									34	33	73			32	30		27	26	25		22	21	20											15	14			10	9		6	5	4													
72	70		67	66		63	62		59	57									53																																																																																					
52	51			46		44	42		40	39									34	33																																																																																				
73			32	30		27	26	25		22	21	20																																																																																												
			15	14			10	9		6	5	4																																																																																												
										AVAILABLE	NOT APPLICABLE	34566-1883	G	0	A	BLACK	<table border="1"> <tr><td></td><td>70</td><td>68</td><td>67</td><td>66</td><td>65</td><td></td><td></td><td></td><td></td><td>58</td><td>57</td><td>55</td><td></td><td></td><td></td><td></td><td></td><td></td><td></td></tr> <tr><td></td><td>49</td><td>47</td><td></td><td></td><td>44</td><td>43</td><td>42</td><td>41</td><td>40</td><td>39</td><td>37</td><td>35</td><td></td><td></td><td></td><td></td><td></td><td></td><td></td></tr> <tr><td colspan="2">73</td><td>32</td><td>30</td><td></td><td></td><td>27</td><td>26</td><td>25</td><td>24</td><td></td><td>21</td><td>20</td><td>19</td><td>18</td><td>17</td><td></td><td></td><td></td><td></td></tr> <tr><td colspan="2"></td><td>16</td><td>15</td><td>13</td><td></td><td></td><td>10</td><td>9</td><td>8</td><td></td><td>6</td><td>5</td><td>4</td><td></td><td></td><td></td><td></td><td></td><td></td></tr> </table>		70	68	67	66	65					58	57	55									49	47			44	43	42	41	40	39	37	35								73		32	30			27	26	25	24		21	20	19	18	17							16	15	13			10	9	8		6	5	4													
	70	68	67	66	65					58	57	55																																																																																												
	49	47			44	43	42	41	40	39	37	35																																																																																												
73		32	30			27	26	25	24		21	20	19	18	17																																																																																									
		16	15	13			10	9	8		6	5	4																																																																																											
										AVAILABLE	NOT APPLICABLE	34566-1893	G	0	C	BLUE	<table border="1"> <tr><td>72</td><td>70</td><td></td><td></td><td>66</td><td></td><td>63</td><td></td><td></td><td>59</td><td>57</td><td></td><td></td><td></td><td></td><td></td><td></td><td></td><td></td><td>53</td></tr> <tr><td>52</td><td>51</td><td></td><td></td><td>46</td><td></td><td>44</td><td>42</td><td></td><td>40</td><td>39</td><td></td><td></td><td></td><td></td><td></td><td></td><td></td><td></td><td>34</td><td>33</td></tr> <tr><td colspan="2">73</td><td></td><td>32</td><td>30</td><td></td><td>27</td><td>26</td><td>25</td><td></td><td>22</td><td>21</td><td>20</td><td></td><td></td><td></td><td></td><td></td><td></td><td></td></tr> <tr><td colspan="2"></td><td></td><td>15</td><td>14</td><td></td><td></td><td>10</td><td>9</td><td></td><td>6</td><td>5</td><td>4</td><td></td><td></td><td></td><td></td><td></td><td></td><td></td></tr> </table>	72	70			66		63			59	57									53	52	51			46		44	42		40	39									34	33	73			32	30		27	26	25		22	21	20											15	14			10	9		6	5	4													
72	70			66		63			59	57									53																																																																																					
52	51			46		44	42		40	39									34	33																																																																																				
73			32	30		27	26	25		22	21	20																																																																																												
			15	14			10	9		6	5	4																																																																																												
										AVAILABLE	NOT APPLICABLE	34566-1913	G	0	B	ST GRY	<table border="1"> <tr><td>72</td><td>70</td><td>68</td><td>66</td><td></td><td></td><td></td><td></td><td></td><td>60</td><td>59</td><td></td><td></td><td></td><td></td><td></td><td></td><td></td><td>55</td><td>54</td><td>53</td></tr> <tr><td>52</td><td>50</td><td>48</td><td>46</td><td></td><td></td><td></td><td></td><td></td><td>40</td><td>39</td><td></td><td></td><td></td><td></td><td></td><td></td><td></td><td>35</td><td>34</td><td>33</td></tr> <tr><td colspan="2">73</td><td>32</td><td>31</td><td>30</td><td>29</td><td>28</td><td>27</td><td>26</td><td>25</td><td>24</td><td></td><td></td><td></td><td></td><td></td><td></td><td></td><td></td><td></td><td></td></tr> <tr><td colspan="2"></td><td>16</td><td></td><td></td><td></td><td></td><td></td><td>10</td><td>9</td><td>8</td><td></td><td></td><td></td><td></td><td></td><td></td><td></td><td></td><td></td><td></td></tr> </table>	72	70	68	66						60	59								55	54	53	52	50	48	46						40	39								35	34	33	73		32	31	30	29	28	27	26	25	24													16						10	9	8													
72	70	68	66						60	59								55	54	53																																																																																				
52	50	48	46						40	39								35	34	33																																																																																				
73		32	31	30	29	28	27	26	25	24																																																																																														
		16						10	9	8																																																																																														
										AVAILABLE	NOT APPLICABLE	34566-1923	G	0	A	BLACK	<table border="1"> <tr><td></td><td></td><td>69</td><td></td><td></td><td></td><td>63</td><td></td><td></td><td></td><td>58</td><td>56</td><td>55</td><td>54</td><td>53</td><td></td><td></td><td></td><td></td><td></td></tr> <tr><td>52</td><td>51</td><td>49</td><td></td><td></td><td></td><td>44</td><td>43</td><td>42</td><td>41</td><td></td><td></td><td></td><td></td><td></td><td></td><td></td><td></td><td>36</td><td>35</td><td>34</td><td>33</td></tr> <tr><td colspan="2">73</td><td>32</td><td></td><td></td><td></td><td>28</td><td>26</td><td></td><td></td><td></td><td></td><td></td><td></td><td></td><td></td><td></td><td></td><td>19</td><td>18</td><td></td><td></td></tr> <tr><td colspan="2"></td><td>16</td><td></td><td></td><td></td><td>12</td><td>10</td><td></td><td></td><td></td><td></td><td></td><td></td><td></td><td></td><td></td><td></td><td>3</td><td></td><td></td><td></td></tr> </table>			69				63				58	56	55	54	53						52	51	49				44	43	42	41									36	35	34	33	73		32				28	26											19	18					16				12	10											3				
		69				63				58	56	55	54	53																																																																																										
52	51	49				44	43	42	41									36	35	34	33																																																																																			
73		32				28	26											19	18																																																																																					
		16				12	10											3																																																																																						
										AVAILABLE	NOT APPLICABLE	34566-1933	G	0	A	BLACK	<table border="1"> <tr><td></td><td>70</td><td></td><td>67</td><td>66</td><td>65</td><td></td><td></td><td></td><td></td><td>58</td><td>57</td><td>55</td><td></td><td></td><td></td><td></td><td></td><td></td><td></td><td></td></tr> <tr><td></td><td>49</td><td></td><td>47</td><td></td><td></td><td>44</td><td>43</td><td>42</td><td>41</td><td>40</td><td>39</td><td>37</td><td>35</td><td></td><td></td><td></td><td></td><td></td><td></td><td></td><td></td></tr> <tr><td colspan="2">73</td><td>32</td><td>30</td><td></td><td></td><td>27</td><td>25</td><td>24</td><td></td><td>21</td><td>20</td><td>19</td><td>18</td><td>17</td><td></td><td></td><td></td><td></td><td></td><td></td><td></td></tr> <tr><td colspan="2"></td><td>16</td><td>15</td><td>13</td><td></td><td></td><td>10</td><td>9</td><td>8</td><td>6</td><td>5</td><td>4</td><td></td><td></td><td></td><td></td><td></td><td></td><td></td><td></td><td></td></tr> </table>		70		67	66	65					58	57	55										49		47			44	43	42	41	40	39	37	35									73		32	30			27	25	24		21	20	19	18	17										16	15	13			10	9	8	6	5	4									
	70		67	66	65					58	57	55																																																																																												
	49		47			44	43	42	41	40	39	37	35																																																																																											
73		32	30			27	25	24		21	20	19	18	17																																																																																										
		16	15	13			10	9	8	6	5	4																																																																																												
										AVAILABLE	NOT APPLICABLE	34566-1943	G	0	A	BLACK	<table border="1"> <tr><td></td><td>70</td><td></td><td>67</td><td>66</td><td>65</td><td></td><td></td><td></td><td></td><td>58</td><td>57</td><td>55</td><td></td><td></td><td></td><td></td><td></td><td></td><td></td><td></td></tr> <tr><td>51</td><td>49</td><td></td><td>47</td><td></td><td></td><td>44</td><td>43</td><td>42</td><td>41</td><td>40</td><td>39</td><td>37</td><td>35</td><td></td><td></td><td></td><td></td><td></td><td></td><td></td><td></td></tr> <tr><td colspan="2">73</td><td>32</td><td>30</td><td></td><td></td><td>27</td><td>25</td><td>24</td><td></td><td>21</td><td>20</td><td>19</td><td>18</td><td>17</td><td></td><td></td><td></td><td></td><td></td><td></td><td></td></tr> <tr><td colspan="2"></td><td>16</td><td>15</td><td>13</td><td></td><td></td><td>10</td><td>9</td><td>8</td><td>6</td><td>5</td><td>4</td><td></td><td></td><td></td><td></td><td></td><td></td><td></td><td></td><td></td></tr> </table>		70		67	66	65					58	57	55									51	49		47			44	43	42	41	40	39	37	35									73		32	30			27	25	24		21	20	19	18	17										16	15	13			10	9	8	6	5	4									
	70		67	66	65					58	57	55																																																																																												
51	49		47			44	43	42	41	40	39	37	35																																																																																											
73		32	30			27	25	24		21	20	19	18	17																																																																																										
		16	15	13			10	9	8	6	5	4																																																																																												
										AVAILABLE	NOT APPLICABLE	34566-1953	G	0	C	BLUE	<table border="1"> <tr><td>72</td><td>70</td><td></td><td></td><td>66</td><td></td><td>63</td><td></td><td></td><td>59</td><td>57</td><td></td><td></td><td></td><td></td><td></td><td></td><td></td><td></td><td></td><td>53</td></tr> <tr><td>52</td><td>51</td><td></td><td></td><td>48</td><td>47</td><td>46</td><td>44</td><td>42</td><td>40</td><td>39</td><td></td><td></td><td></td><td></td><td></td><td></td><td></td><td></td><td></td><td>34</td><td>33</td></tr> <tr><td colspan="2">73</td><td></td><td></td><td>30</td><td></td><td></td><td></td><td>26</td><td>25</td><td></td><td>22</td><td>21</td><td>20</td><td></td><td></td><td></td><td></td><td></td><td></td><td></td><td></td></tr> <tr><td colspan="2"></td><td></td><td></td><td>15</td><td>14</td><td></td><td></td><td>10</td><td>9</td><td></td><td>6</td><td>5</td><td>4</td><td></td><td></td><td></td><td></td><td></td><td></td><td></td><td></td></tr> </table>	72	70			66		63			59	57										53	52	51			48	47	46	44	42	40	39										34	33	73				30				26	25		22	21	20													15	14			10	9		6	5	4								
72	70			66		63			59	57										53																																																																																				
52	51			48	47	46	44	42	40	39										34	33																																																																																			
73				30				26	25		22	21	20																																																																																											
				15	14			10	9		6	5	4																																																																																											
										AVAILABLE	NOT APPLICABLE	34566-1963	G	0	C	BLUE	<table border="1"> <tr><td>72</td><td>70</td><td></td><td></td><td>66</td><td></td><td>63</td><td></td><td></td><td>59</td><td>57</td><td></td><td></td><td></td><td></td><td></td><td></td><td></td><td></td><td></td><td>53</td></tr> <tr><td>52</td><td>51</td><td></td><td></td><td>46</td><td></td><td>44</td><td>42</td><td></td><td>40</td><td>39</td><td></td><td></td><td></td><td></td><td></td><td></td><td></td><td></td><td></td><td>34</td><td>33</td></tr> <tr><td colspan="2">73</td><td></td><td></td><td>30</td><td></td><td></td><td></td><td>26</td><td>25</td><td></td><td>22</td><td>21</td><td>20</td><td></td><td></td><td></td><td></td><td></td><td></td><td></td><td></td></tr> <tr><td colspan="2"></td><td></td><td></td><td>15</td><td>14</td><td></td><td></td><td>10</td><td>9</td><td></td><td>6</td><td>5</td><td>4</td><td></td><td></td><td></td><td></td><td></td><td></td><td></td><td></td></tr> </table>	72	70			66		63			59	57										53	52	51			46		44	42		40	39										34	33	73				30				26	25		22	21	20													15	14			10	9		6	5	4								
72	70			66		63			59	57										53																																																																																				
52	51			46		44	42		40	39										34	33																																																																																			
73				30				26	25		22	21	20																																																																																											
				15	14			10	9		6	5	4																																																																																											

ENTER DESCRIPTION EC NO: UAU2010-1551 DRAWN BY: DRWNAH01 CHECKED BY: CHKDRFF1HS APPROVED BY: APPR.VKOSHY DATE: 2010/03/15 DATE: 2008/05/09 DATE: 2010/03/18	QUALITY SYMBOLS	GENERAL TOLERANCES (UNLESS SPECIFIED)	DIMENSION STYLE	SCALE	DESIGN UNITS	THIRD ANGLE PROJECTION	
	$\nabla=0$ $\nabla=0$	4 PLACES ±--- INCH 3 PLACES ±--- INCH 2 PLACES ±--- INCH 1 PLACE ±--- INCH ANGULAR ±---°	MM ONLY	1:1	METRIC		
	DRAWN BY: SRAJENDRANAT CHECKED BY: TSKIVER APPROVED BY: VKOSHY DATE: 2008/05/09 DATE: 2010/03/18	DRAFT WHERE APPLICABLE MUST REMAIN WITHIN DIMENSIONS	SEE BOM TABLE	MATERIAL NO. SD-34566-001 DOCUMENT NO.	TITLE: MX123 73/80 CKT HRNS CONN ASSY	MOLEX INCORPORATED	SHEET NO. 24 OF 36
	THIS DRAWING CONTAINS INFORMATION THAT IS PROPRIETARY TO MOLEX INCORPORATED AND SHOULD NOT BE USED WITHOUT WRITTEN PERMISSION						

20	19	18	17	16	15	14	13	12	11	10	9	8	7	6	5	4	3	2	1							
										STATUS	GM PART #	MATERIAL #	PART / MATERIAL REVISION	WIRE DRESS OPTION	KEY OPTION	COLOR (TPA)	NUMBERS INDICATE CAVITIES OPEN FOR CIRCUITS									
										AVAILABLE	NOT APPLICABLE	34566-2293	G	0	C	BLUE	72 70 68 66 63 59 57 53 52 51 48 47 46 44 42 40 39 34 33 73 30 26 25 22 21 20 18 17 16 15 14 13 12 11 10 9 8 7 6 5 4 3 2 1									
										AVAILABLE	NOT APPLICABLE	34566-2319	G	0	C	BLUE	72 70 68 66 63 59 57 53 52 51 48 47 46 44 42 40 39 34 33 73 30 26 25 22 21 20 18 17 16 15 14 13 12 11 10 9 8 7 6 5 4 3 2 1									
										AVAILABLE	NOT APPLICABLE	34566-2323	G	0	C	BLUE	72 70 68 66 63 59 57 53 52 51 48 47 46 44 42 40 39 34 33 73 30 26 25 22 21 20 18 17 16 15 14 13 12 11 10 9 8 7 6 5 4 3 2 1									
										AVAILABLE	NOT APPLICABLE	34566-2333	G	0	A	BLACK	71 69 68 65 64 63 61 59 57 56 55 54 53 52 50 49 47 46 45 44 43 42 41 39 38 37 36 35 34 33 73 32 31 30 29 28 27 26 25 24 23 22 21 20 19 18 17 16 15 14 13 12 11 10 9 8 7 6 5 4 3 2 1									
										AVAILABLE	NOT APPLICABLE	34566-2343	G	0	A	BLACK	72 70 68 67 66 65 64 63 62 61 59 57 55 54 53 52 51 49 47 46 45 44 43 42 41 39 37 35 34 33 73 32 30 27 25 24 23 22 21 20 19 18 17 16 15 14 13 12 11 10 9 8 7 6 5 4 3 2 1									
										AVAILABLE	NOT APPLICABLE	34566-2353	G	0	A	BLACK	72 70 67 66 65 64 63 62 61 59 57 55 54 53 52 51 49 47 46 45 44 43 42 41 39 37 35 34 33 73 32 30 27 25 24 23 22 21 20 19 18 17 16 15 14 13 12 11 10 9 8 7 6 5 4 3 2 1									
										AVAILABLE	NOT APPLICABLE	34566-2363	G	0	C	BLUE	72 70 67 66 63 62 59 57 53 52 51 48 47 46 44 42 40 39 38 34 33 73 32 30 27 26 25 24 23 22 21 20 19 18 17 16 15 14 13 12 11 10 9 8 7 6 5 4 3 2 1									
										AVAILABLE	NOT APPLICABLE	34566-2373	G	0	B	ST GRAY	68 67 66 65 64 61 60 59 58 57 55 54 53 51 50 49 48 47 46 45 43 42 41 40 39 38 37 35 34 33 73 32 31 30 26 24 23 22 21 20 19 18 17 16 15 14 13 12 11 10 9 8 7 6 5 4 3 2 1									
										AVAILABLE	NOT APPLICABLE	34566-2383	G	0	B	ST GRAY	65 59 57 55 53 50 49 48 46 44 43 42 41 40 39 38 37 35 34 33 73 15 29 24 23 21 20 19 18 17 16 15 14 13 12 11 10 9 8 7 6 5 4 3 2 1									

ENTER DESCRIPTION EC NO: UAU2010-151 DRAWN BY: SRAJENDRANAT CHECKED BY: TSK IVER APPROVED BY: VKOSHY DATE: 2010/03/18 SHEET NO: 28 OF 36	QUALITY SYMBOLS 0 1 2 3 4 ANGULAR ±---°	GENERAL TOLERANCES (UNLESS SPECIFIED) <table border="1"> <tr><th></th><th>mm</th><th>INCH</th></tr> <tr><td>4 PLACES</td><td>±---</td><td>±---</td></tr> <tr><td>3 PLACES</td><td>±---</td><td>±---</td></tr> <tr><td>2 PLACES</td><td>±---</td><td>±---</td></tr> <tr><td>1 PLACE</td><td>±---</td><td>±---</td></tr> </table>		mm	INCH	4 PLACES	±---	±---	3 PLACES	±---	±---	2 PLACES	±---	±---	1 PLACE	±---	±---	DIMENSION STYLE MM ONLY	SCALE 1:1	DESIGN UNITS METRIC	THIRD ANGLE PROJECTION
		mm	INCH																		
	4 PLACES	±---	±---																		
	3 PLACES	±---	±---																		
2 PLACES	±---	±---																			
1 PLACE	±---	±---																			
DRAFT WHERE APPLICABLE MUST REMAIN WITHIN DIMENSIONS		SEE BOM TABLE	DOCUMENT NO: SD-34566-001	MOLEX INCORPORATED																	
THIS DRAWING CONTAINS INFORMATION THAT IS PROPRIETARY TO MOLEX INCORPORATED AND SHOULD NOT BE USED WITHOUT WRITTEN PERMISSION																					

STATUS	GM PART #	MATERIAL #	PART / MATERIAL REVISION	WIRE DRESS OPTION	KEY OPTION	COLOR (TPA)	NUMBERS INDICATE CAVITIES OPEN FOR CIRCUITS																																																																																			
AVAILABLE	NOT APPLICABLE	34566-2483	G	0	A	BLACK	<table border="1"> <tr><td></td><td></td><td>69</td><td></td><td></td><td></td><td>63</td><td>62</td><td>61</td><td></td><td>58</td><td>57</td><td>56</td><td>55</td><td>54</td><td>53</td></tr> <tr><td>52</td><td>51</td><td>49</td><td></td><td></td><td></td><td>44</td><td>43</td><td>42</td><td>41</td><td></td><td>37</td><td>36</td><td>35</td><td>34</td><td>33</td></tr> <tr><td></td><td></td><td>73</td><td></td><td>32</td><td></td><td>29</td><td>28</td><td>27</td><td>26</td><td></td><td>23</td><td></td><td></td><td>19</td><td>18</td></tr> <tr><td></td><td></td><td></td><td></td><td>16</td><td></td><td>13</td><td>12</td><td>11</td><td>10</td><td></td><td>8</td><td></td><td></td><td>3</td><td></td></tr> </table>			69				63	62	61		58	57	56	55	54	53	52	51	49				44	43	42	41		37	36	35	34	33			73		32		29	28	27	26		23			19	18					16		13	12	11	10		8			3																				
		69				63	62	61		58	57	56	55	54	53																																																																											
52	51	49				44	43	42	41		37	36	35	34	33																																																																											
		73		32		29	28	27	26		23			19	18																																																																											
				16		13	12	11	10		8			3																																																																												
AVAILABLE	NOT APPLICABLE	34566-2493	G	0	B	ST GRAY	<table border="1"> <tr><td>72</td><td>71</td><td>70</td><td></td><td>68</td><td>67</td><td>66</td><td></td><td></td><td>62</td><td>61</td><td>60</td><td>59</td><td>58</td><td>57</td><td>56</td><td>55</td><td>54</td><td>53</td></tr> <tr><td>52</td><td>51</td><td>50</td><td></td><td>48</td><td>47</td><td>46</td><td></td><td></td><td>42</td><td>41</td><td>40</td><td>39</td><td>38</td><td>37</td><td>36</td><td>35</td><td>34</td><td>33</td></tr> <tr><td></td><td></td><td>73</td><td></td><td>32</td><td>31</td><td>30</td><td>29</td><td>28</td><td>27</td><td>26</td><td>25</td><td>24</td><td></td><td></td><td></td><td></td><td></td><td>17</td></tr> <tr><td></td><td></td><td></td><td></td><td>16</td><td>15</td><td>14</td><td>13</td><td></td><td></td><td>10</td><td>8</td><td></td><td></td><td></td><td></td><td></td><td></td><td>2</td><td>1</td></tr> </table>	72	71	70		68	67	66			62	61	60	59	58	57	56	55	54	53	52	51	50		48	47	46			42	41	40	39	38	37	36	35	34	33			73		32	31	30	29	28	27	26	25	24						17					16	15	14	13			10	8							2	1						
72	71	70		68	67	66			62	61	60	59	58	57	56	55	54	53																																																																								
52	51	50		48	47	46			42	41	40	39	38	37	36	35	34	33																																																																								
		73		32	31	30	29	28	27	26	25	24						17																																																																								
				16	15	14	13			10	8							2	1																																																																							
AVAILABLE	NOT APPLICABLE	34566-2513	G	0	C	BLUE	<table border="1"> <tr><td>72</td><td>71</td><td>70</td><td></td><td>68</td><td>67</td><td>66</td><td></td><td></td><td>63</td><td>62</td><td></td><td>59</td><td>57</td><td></td><td></td><td></td><td></td><td>53</td></tr> <tr><td>52</td><td>51</td><td></td><td></td><td>48</td><td>47</td><td>46</td><td></td><td>44</td><td></td><td>42</td><td></td><td>40</td><td>39</td><td></td><td></td><td></td><td></td><td>34</td><td>33</td></tr> <tr><td></td><td></td><td>73</td><td></td><td>32</td><td></td><td>30</td><td></td><td></td><td>27</td><td>26</td><td>25</td><td></td><td>22</td><td>21</td><td>20</td><td></td><td></td><td></td><td></td></tr> <tr><td></td><td></td><td></td><td></td><td>15</td><td>14</td><td></td><td></td><td></td><td></td><td>10</td><td>9</td><td></td><td>6</td><td>5</td><td>4</td><td></td><td></td><td></td><td></td></tr> </table>	72	71	70		68	67	66			63	62		59	57					53	52	51			48	47	46		44		42		40	39					34	33			73		32		30			27	26	25		22	21	20									15	14					10	9		6	5	4								
72	71	70		68	67	66			63	62		59	57					53																																																																								
52	51			48	47	46		44		42		40	39					34	33																																																																							
		73		32		30			27	26	25		22	21	20																																																																											
				15	14					10	9		6	5	4																																																																											
AVAILABLE	NOT APPLICABLE	34566-2523	G	0	A	BLACK	<table border="1"> <tr><td>72</td><td>71</td><td>70</td><td>69</td><td>68</td><td>67</td><td>66</td><td>65</td><td>64</td><td>63</td><td>62</td><td></td><td>60</td><td>59</td><td></td><td></td><td></td><td>55</td><td>54</td><td>53</td></tr> <tr><td>52</td><td></td><td>49</td><td>48</td><td></td><td>45</td><td>44</td><td>43</td><td>42</td><td>41</td><td>40</td><td>39</td><td></td><td></td><td></td><td></td><td></td><td></td><td>35</td><td>34</td><td>33</td></tr> <tr><td></td><td></td><td>73</td><td></td><td>32</td><td></td><td>29</td><td>28</td><td>27</td><td></td><td>25</td><td>24</td><td>23</td><td></td><td></td><td></td><td></td><td></td><td>19</td><td>18</td><td>17</td></tr> <tr><td></td><td></td><td></td><td></td><td>16</td><td></td><td>13</td><td>12</td><td>11</td><td></td><td>9</td><td>8</td><td>7</td><td>6</td><td>5</td><td>4</td><td>3</td><td>2</td><td>1</td><td></td><td></td></tr> </table>	72	71	70	69	68	67	66	65	64	63	62		60	59				55	54	53	52		49	48		45	44	43	42	41	40	39							35	34	33			73		32		29	28	27		25	24	23						19	18	17					16		13	12	11		9	8	7	6	5	4	3	2	1		
72	71	70	69	68	67	66	65	64	63	62		60	59				55	54	53																																																																							
52		49	48		45	44	43	42	41	40	39							35	34	33																																																																						
		73		32		29	28	27		25	24	23						19	18	17																																																																						
				16		13	12	11		9	8	7	6	5	4	3	2	1																																																																								
AVAILABLE	NOT APPLICABLE	34566-2533	G	0	B	ST GRAY	<table border="1"> <tr><td></td><td></td><td></td><td></td><td>67</td><td>66</td><td>65</td><td>63</td><td></td><td></td><td></td><td></td><td>59</td><td>58</td><td>57</td><td>56</td><td>55</td><td></td><td></td><td>53</td></tr> <tr><td></td><td></td><td>50</td><td>49</td><td>48</td><td></td><td>46</td><td>45</td><td>43</td><td></td><td></td><td></td><td>39</td><td>38</td><td>37</td><td>36</td><td>35</td><td>34</td><td></td><td>33</td></tr> <tr><td></td><td></td><td>73</td><td></td><td></td><td></td><td>29</td><td></td><td>27</td><td></td><td></td><td></td><td>23</td><td>22</td><td>21</td><td></td><td></td><td></td><td>18</td><td></td></tr> <tr><td></td><td></td><td></td><td></td><td>16</td><td>15</td><td>14</td><td>13</td><td></td><td></td><td></td><td>8</td><td>7</td><td>6</td><td>5</td><td>4</td><td>3</td><td></td><td></td><td></td></tr> </table>					67	66	65	63					59	58	57	56	55			53			50	49	48		46	45	43				39	38	37	36	35	34		33			73				29		27				23	22	21				18						16	15	14	13				8	7	6	5	4	3						
				67	66	65	63					59	58	57	56	55			53																																																																							
		50	49	48		46	45	43				39	38	37	36	35	34		33																																																																							
		73				29		27				23	22	21				18																																																																								
				16	15	14	13				8	7	6	5	4	3																																																																										
AVAILABLE	NOT APPLICABLE	34566-2543	G	0	C	BLUE	<table border="1"> <tr><td>72</td><td>71</td><td>70</td><td></td><td></td><td></td><td>66</td><td></td><td></td><td>63</td><td></td><td></td><td>59</td><td>57</td><td></td><td></td><td></td><td></td><td></td><td>53</td></tr> <tr><td>52</td><td>51</td><td></td><td></td><td></td><td></td><td>46</td><td></td><td>44</td><td></td><td>42</td><td></td><td>40</td><td>39</td><td></td><td></td><td></td><td></td><td></td><td>34</td><td>33</td></tr> <tr><td></td><td></td><td>73</td><td></td><td></td><td></td><td>32</td><td></td><td>30</td><td></td><td>27</td><td>26</td><td>25</td><td></td><td>22</td><td>21</td><td></td><td></td><td></td><td></td><td></td></tr> <tr><td></td><td></td><td></td><td></td><td></td><td></td><td>15</td><td>14</td><td></td><td></td><td></td><td>10</td><td>9</td><td></td><td>6</td><td></td><td></td><td></td><td></td><td></td><td></td></tr> </table>	72	71	70				66			63			59	57						53	52	51					46		44		42		40	39						34	33			73				32		30		27	26	25		22	21												15	14				10	9		6						
72	71	70				66			63			59	57						53																																																																							
52	51					46		44		42		40	39						34	33																																																																						
		73				32		30		27	26	25		22	21																																																																											
						15	14				10	9		6																																																																												
AVAILABLE	NOT APPLICABLE	34566-2553	G	9	B	ST GRAY	<table border="1"> <tr><td>72</td><td>71</td><td>70</td><td></td><td>68</td><td>67</td><td>66</td><td></td><td></td><td>62</td><td>61</td><td>60</td><td>59</td><td>58</td><td>57</td><td>56</td><td>55</td><td>54</td><td>53</td></tr> <tr><td>52</td><td>51</td><td>50</td><td></td><td>48</td><td>47</td><td>46</td><td></td><td></td><td>42</td><td>41</td><td>40</td><td>39</td><td>38</td><td>37</td><td>36</td><td>35</td><td>34</td><td>33</td></tr> <tr><td></td><td></td><td>73</td><td></td><td>32</td><td>31</td><td>30</td><td>29</td><td>28</td><td>27</td><td>26</td><td>25</td><td>24</td><td>23</td><td></td><td></td><td></td><td></td><td></td><td></td></tr> <tr><td></td><td></td><td></td><td></td><td>16</td><td>15</td><td>14</td><td>13</td><td></td><td></td><td>10</td><td>9</td><td>8</td><td></td><td></td><td></td><td></td><td></td><td></td><td></td></tr> </table>	72	71	70		68	67	66			62	61	60	59	58	57	56	55	54	53	52	51	50		48	47	46			42	41	40	39	38	37	36	35	34	33			73		32	31	30	29	28	27	26	25	24	23											16	15	14	13			10	9	8												
72	71	70		68	67	66			62	61	60	59	58	57	56	55	54	53																																																																								
52	51	50		48	47	46			42	41	40	39	38	37	36	35	34	33																																																																								
		73		32	31	30	29	28	27	26	25	24	23																																																																													
				16	15	14	13			10	9	8																																																																														
AVAILABLE	NOT APPLICABLE	34566-2563	G	9	A	BLACK	<table border="1"> <tr><td></td><td></td><td>69</td><td></td><td></td><td></td><td></td><td></td><td></td><td>63</td><td>62</td><td>61</td><td></td><td>58</td><td>57</td><td>56</td><td>55</td><td>54</td><td>53</td></tr> <tr><td>52</td><td>51</td><td>50</td><td>49</td><td></td><td></td><td></td><td></td><td></td><td>44</td><td>43</td><td>42</td><td>41</td><td></td><td>37</td><td>36</td><td>35</td><td>34</td><td>33</td></tr> <tr><td></td><td></td><td>73</td><td></td><td>32</td><td></td><td></td><td>29</td><td>28</td><td>27</td><td>26</td><td></td><td></td><td></td><td></td><td></td><td></td><td>19</td><td>18</td></tr> <tr><td></td><td></td><td></td><td></td><td>16</td><td></td><td>14</td><td>13</td><td>12</td><td>11</td><td>10</td><td></td><td></td><td></td><td></td><td></td><td></td><td>3</td><td></td></tr> </table>			69							63	62	61		58	57	56	55	54	53	52	51	50	49						44	43	42	41		37	36	35	34	33			73		32			29	28	27	26							19	18					16		14	13	12	11	10							3								
		69							63	62	61		58	57	56	55	54	53																																																																								
52	51	50	49						44	43	42	41		37	36	35	34	33																																																																								
		73		32			29	28	27	26							19	18																																																																								
				16		14	13	12	11	10							3																																																																									
AVAILABLE	NOT APPLICABLE	34566-2573	G	9	C	BLUE	<table border="1"> <tr><td>72</td><td>71</td><td>70</td><td></td><td></td><td></td><td>67</td><td>66</td><td></td><td>63</td><td>62</td><td></td><td>59</td><td>57</td><td></td><td></td><td></td><td></td><td></td><td>53</td></tr> <tr><td>52</td><td>51</td><td></td><td></td><td></td><td></td><td>46</td><td>44</td><td></td><td>42</td><td></td><td>40</td><td>39</td><td></td><td></td><td></td><td></td><td></td><td></td><td>34</td><td>33</td></tr> <tr><td></td><td></td><td>73</td><td></td><td></td><td></td><td>30</td><td></td><td></td><td>26</td><td>25</td><td></td><td></td><td>22</td><td>21</td><td>20</td><td></td><td></td><td></td><td></td><td></td></tr> <tr><td></td><td></td><td></td><td></td><td></td><td></td><td>15</td><td>14</td><td></td><td></td><td>10</td><td>9</td><td></td><td>6</td><td>5</td><td>4</td><td></td><td></td><td></td><td></td><td></td></tr> </table>	72	71	70				67	66		63	62		59	57						53	52	51					46	44		42		40	39							34	33			73				30			26	25			22	21	20												15	14			10	9		6	5	4					
72	71	70				67	66		63	62		59	57						53																																																																							
52	51					46	44		42		40	39							34	33																																																																						
		73				30			26	25			22	21	20																																																																											
						15	14			10	9		6	5	4																																																																											

ENTER DESCRIPTION TEC NO. JAU2010-1551 DRAWN BY CHYKORFF JHS CHECKED BY APPR:VKOSHY DATE 2010/03/15 DATE 2008/05/09 DATE 2010/03/18	QUALITY SYMBOLS ▽=0 ▽=0	GENERAL TOLERANCES (UNLESS SPECIFIED) mm INCH 4 PLACES ±--- ±--- 3 PLACES ±--- ±--- 2 PLACES ±--- ±--- 1 PLACE ±--- ±--- ANGULAR ±----°	DIMENSION STYLE MM ONLY	SCALE 1:1	DESIGN UNITS METRIC	THIRD ANGLE PROJECTION 	
	DRAWN BY DATE SRAJENDRANAT 2008/05/09	CHECKED BY DATE TSK IVER 2008/05/09	APPROVED BY DATE VKOSHY 2010/03/18	MATERIAL NO. SEE BOM TABLE	DOCUMENT NO. SD-34566-001	SHEET NO. 30 OF 36	TITLE MX123 73/80 CKT HRNS CONN ASSY
	DRAFT WHERE APPLICABLE MUST REMAIN WITHIN DIMENSIONS			MOLEX INCORPORATED			
	THIS DRAWING CONTAINS INFORMATION THAT IS PROPRIETARY TO MOLEX INCORPORATED AND SHOULD NOT BE USED WITHOUT WRITTEN PERMISSION			MOLEX INCORPORATED			

STATUS	GM PART #	MATERIAL #	PART/MATERIAL REVISION	WIRE DRESS OPTION	KEY OPTION	COLOR (TPA)	NUMBERS INDICATE CAVITIES OPEN FOR CIRCUITS																																																																														
AVAILABLE	NOT APPLICABLE	34566-2583	G	0	A	BLACK	<table border="1"> <tr><td></td><td></td><td>69</td><td></td><td></td><td></td><td>63</td><td></td><td></td><td>58</td><td>56</td><td>55</td><td>54</td><td>53</td></tr> <tr><td>52</td><td>51</td><td>50</td><td>49</td><td></td><td></td><td>44</td><td>43</td><td>42</td><td>41</td><td>39</td><td></td><td>36</td><td>35</td><td>34</td><td>33</td></tr> <tr><td></td><td></td><td>73</td><td>32</td><td></td><td></td><td>28</td><td>26</td><td></td><td></td><td></td><td></td><td>19</td><td>18</td><td></td><td></td></tr> <tr><td></td><td></td><td></td><td>16</td><td>14</td><td></td><td>12</td><td>10</td><td></td><td></td><td></td><td></td><td></td><td>3</td><td></td><td></td></tr> </table>			69				63			58	56	55	54	53	52	51	50	49			44	43	42	41	39		36	35	34	33			73	32			28	26					19	18						16	14		12	10						3																		
		69				63			58	56	55	54	53																																																																								
52	51	50	49			44	43	42	41	39		36	35	34	33																																																																						
		73	32			28	26					19	18																																																																								
			16	14		12	10						3																																																																								
AVAILABLE	NOT APPLICABLE	34566-2593	G	0	C	BLUE	<table border="1"> <tr><td>72</td><td>70</td><td></td><td></td><td>66</td><td></td><td>63</td><td>62</td><td></td><td>59</td><td>57</td><td></td><td></td><td></td><td></td><td>53</td></tr> <tr><td>52</td><td>51</td><td></td><td></td><td>46</td><td>44</td><td>42</td><td>40</td><td>39</td><td></td><td></td><td></td><td></td><td></td><td>34</td><td>33</td></tr> <tr><td></td><td></td><td>73</td><td>32</td><td>30</td><td></td><td>27</td><td>26</td><td>25</td><td></td><td>22</td><td>21</td><td></td><td></td><td></td><td></td></tr> <tr><td></td><td></td><td></td><td>15</td><td>14</td><td></td><td></td><td>10</td><td>9</td><td></td><td>6</td><td></td><td></td><td></td><td></td><td></td></tr> </table>	72	70			66		63	62		59	57					53	52	51			46	44	42	40	39						34	33			73	32	30		27	26	25		22	21								15	14			10	9		6																			
72	70			66		63	62		59	57					53																																																																						
52	51			46	44	42	40	39						34	33																																																																						
		73	32	30		27	26	25		22	21																																																																										
			15	14			10	9		6																																																																											
AVAILABLE	NOT APPLICABLE	34566-2613	G	9	C	BLUE	<table border="1"> <tr><td>72</td><td>70</td><td></td><td>67</td><td>66</td><td></td><td>63</td><td>62</td><td></td><td>59</td><td>57</td><td></td><td></td><td></td><td></td><td>53</td></tr> <tr><td>52</td><td>51</td><td></td><td></td><td>46</td><td>44</td><td>42</td><td>40</td><td>39</td><td></td><td></td><td></td><td></td><td></td><td>34</td><td>33</td></tr> <tr><td></td><td></td><td>73</td><td></td><td>30</td><td></td><td>27</td><td>26</td><td>25</td><td></td><td>22</td><td>21</td><td>20</td><td></td><td></td><td></td></tr> <tr><td></td><td></td><td></td><td>15</td><td>14</td><td></td><td></td><td>10</td><td>9</td><td></td><td>6</td><td>5</td><td>4</td><td></td><td></td><td></td></tr> </table>	72	70		67	66		63	62		59	57					53	52	51			46	44	42	40	39						34	33			73		30		27	26	25		22	21	20							15	14			10	9		6	5	4																	
72	70		67	66		63	62		59	57					53																																																																						
52	51			46	44	42	40	39						34	33																																																																						
		73		30		27	26	25		22	21	20																																																																									
			15	14			10	9		6	5	4																																																																									
AVAILABLE	NOT APPLICABLE	34566-2623	G	0	A	BLACK	<table border="1"> <tr><td></td><td>71</td><td>69</td><td>68</td><td>67</td><td>65</td><td>64</td><td>63</td><td></td><td>61</td><td>59</td><td>57</td><td>56</td><td></td><td></td><td></td></tr> <tr><td></td><td></td><td>50</td><td>49</td><td>47</td><td></td><td></td><td></td><td></td><td>41</td><td></td><td>38</td><td>37</td><td>36</td><td></td><td>34</td><td>33</td></tr> <tr><td></td><td></td><td>73</td><td>32</td><td>31</td><td>30</td><td>29</td><td>28</td><td>27</td><td></td><td>24</td><td>23</td><td></td><td>20</td><td>19</td><td>18</td><td></td></tr> <tr><td></td><td></td><td></td><td>16</td><td></td><td></td><td>13</td><td>12</td><td>11</td><td>10</td><td>9</td><td>7</td><td></td><td>4</td><td></td><td></td><td></td></tr> </table>		71	69	68	67	65	64	63		61	59	57	56						50	49	47					41		38	37	36		34	33			73	32	31	30	29	28	27		24	23		20	19	18					16			13	12	11	10	9	7		4														
	71	69	68	67	65	64	63		61	59	57	56																																																																									
		50	49	47					41		38	37	36		34	33																																																																					
		73	32	31	30	29	28	27		24	23		20	19	18																																																																						
			16			13	12	11	10	9	7		4																																																																								
AVAILABLE	NOT APPLICABLE	34566-2633	G	0	A	BLACK	<table border="1"> <tr><td></td><td>71</td><td>69</td><td>68</td><td>67</td><td>65</td><td>64</td><td></td><td></td><td>61</td><td>59</td><td>57</td><td>56</td><td></td><td></td><td></td><td></td></tr> <tr><td></td><td></td><td>50</td><td>49</td><td>47</td><td></td><td></td><td></td><td></td><td>41</td><td></td><td>38</td><td>37</td><td>36</td><td></td><td>34</td><td>33</td></tr> <tr><td></td><td></td><td>73</td><td>32</td><td>31</td><td>30</td><td>29</td><td>28</td><td>27</td><td></td><td>24</td><td>23</td><td></td><td>20</td><td>19</td><td>18</td><td></td></tr> <tr><td></td><td></td><td></td><td>16</td><td></td><td></td><td></td><td>11</td><td>10</td><td>9</td><td>7</td><td></td><td>4</td><td></td><td></td><td></td><td></td></tr> </table>		71	69	68	67	65	64			61	59	57	56							50	49	47					41		38	37	36		34	33			73	32	31	30	29	28	27		24	23		20	19	18					16				11	10	9	7		4														
	71	69	68	67	65	64			61	59	57	56																																																																									
		50	49	47					41		38	37	36		34	33																																																																					
		73	32	31	30	29	28	27		24	23		20	19	18																																																																						
			16				11	10	9	7		4																																																																									
AVAILABLE	NOT APPLICABLE	34566-2643	G	0	A	BLACK	<table border="1"> <tr><td></td><td>71</td><td>69</td><td>68</td><td>67</td><td>65</td><td>64</td><td>63</td><td></td><td>61</td><td>59</td><td>57</td><td>56</td><td></td><td></td><td></td><td></td></tr> <tr><td></td><td></td><td>50</td><td>49</td><td>47</td><td></td><td></td><td></td><td></td><td>41</td><td>39</td><td>38</td><td>37</td><td>36</td><td></td><td>34</td><td>33</td></tr> <tr><td></td><td></td><td>73</td><td>32</td><td>31</td><td>30</td><td>29</td><td>28</td><td>27</td><td></td><td>24</td><td>23</td><td>22</td><td></td><td>20</td><td>19</td><td>18</td></tr> <tr><td></td><td></td><td></td><td>16</td><td></td><td></td><td>13</td><td>12</td><td>11</td><td>10</td><td>9</td><td>7</td><td></td><td>4</td><td></td><td></td><td></td></tr> </table>		71	69	68	67	65	64	63		61	59	57	56							50	49	47					41	39	38	37	36		34	33			73	32	31	30	29	28	27		24	23	22		20	19	18				16			13	12	11	10	9	7		4													
	71	69	68	67	65	64	63		61	59	57	56																																																																									
		50	49	47					41	39	38	37	36		34	33																																																																					
		73	32	31	30	29	28	27		24	23	22		20	19	18																																																																					
			16			13	12	11	10	9	7		4																																																																								
AVAILABLE	NOT APPLICABLE	34566-2653	G	0	A	BLACK	<table border="1"> <tr><td></td><td>71</td><td>69</td><td>68</td><td>67</td><td>65</td><td>64</td><td></td><td></td><td>61</td><td>59</td><td>57</td><td>56</td><td></td><td></td><td></td><td></td></tr> <tr><td></td><td></td><td>50</td><td>49</td><td>47</td><td></td><td></td><td></td><td></td><td>41</td><td>39</td><td>38</td><td>37</td><td>36</td><td></td><td>34</td><td>33</td></tr> <tr><td></td><td></td><td>73</td><td>32</td><td>31</td><td>30</td><td>29</td><td>28</td><td>27</td><td></td><td>24</td><td>23</td><td>22</td><td></td><td>20</td><td>19</td><td>18</td></tr> <tr><td></td><td></td><td></td><td>16</td><td></td><td></td><td></td><td>11</td><td>10</td><td>9</td><td>7</td><td></td><td>4</td><td></td><td></td><td></td><td></td></tr> </table>		71	69	68	67	65	64			61	59	57	56							50	49	47					41	39	38	37	36		34	33			73	32	31	30	29	28	27		24	23	22		20	19	18				16				11	10	9	7		4														
	71	69	68	67	65	64			61	59	57	56																																																																									
		50	49	47					41	39	38	37	36		34	33																																																																					
		73	32	31	30	29	28	27		24	23	22		20	19	18																																																																					
			16				11	10	9	7		4																																																																									
AVAILABLE	NOT APPLICABLE	34566-2663	G	0	H	ST GRAY	<table border="1"> <tr><td></td><td>79</td><td>78</td><td>77</td><td>76</td><td>75</td><td>74</td><td>73</td><td>72</td><td>71</td><td>70</td><td>69</td><td>68</td><td></td><td>66</td><td>65</td><td>64</td><td>63</td><td>61</td></tr> <tr><td>60</td><td>59</td><td>58</td><td>57</td><td>56</td><td></td><td></td><td>53</td><td>52</td><td></td><td>50</td><td></td><td></td><td></td><td></td><td></td><td>44</td><td>43</td><td>41</td></tr> <tr><td>40</td><td>39</td><td>38</td><td>37</td><td></td><td>35</td><td>34</td><td></td><td>32</td><td></td><td>30</td><td>29</td><td></td><td>27</td><td>26</td><td></td><td></td><td></td><td>22</td><td>21</td></tr> <tr><td>20</td><td>19</td><td>18</td><td>17</td><td></td><td></td><td></td><td>13</td><td>12</td><td></td><td></td><td></td><td>8</td><td></td><td>6</td><td>5</td><td></td><td>3</td><td>2</td><td></td></tr> </table>		79	78	77	76	75	74	73	72	71	70	69	68		66	65	64	63	61	60	59	58	57	56			53	52		50						44	43	41	40	39	38	37		35	34		32		30	29		27	26				22	21	20	19	18	17				13	12				8		6	5		3	2	
	79	78	77	76	75	74	73	72	71	70	69	68		66	65	64	63	61																																																																			
60	59	58	57	56			53	52		50						44	43	41																																																																			
40	39	38	37		35	34		32		30	29		27	26				22	21																																																																		
20	19	18	17				13	12				8		6	5		3	2																																																																			
AVAILABLE	NOT APPLICABLE	34566-2673	G	0	H	ST GRAY	<table border="1"> <tr><td></td><td>79</td><td>78</td><td>77</td><td>76</td><td>75</td><td>74</td><td>73</td><td>72</td><td>71</td><td>70</td><td>69</td><td>68</td><td></td><td>66</td><td>65</td><td>64</td><td>63</td><td>61</td></tr> <tr><td>60</td><td>59</td><td>58</td><td>57</td><td>56</td><td></td><td></td><td>53</td><td>52</td><td></td><td>50</td><td></td><td></td><td></td><td></td><td></td><td>44</td><td>43</td><td>41</td></tr> <tr><td>40</td><td>39</td><td>38</td><td>37</td><td></td><td>35</td><td>34</td><td></td><td>32</td><td></td><td>30</td><td>29</td><td></td><td>27</td><td>26</td><td></td><td></td><td></td><td>22</td><td>21</td></tr> <tr><td>20</td><td>19</td><td>18</td><td>17</td><td>16</td><td></td><td></td><td>13</td><td>12</td><td></td><td></td><td></td><td>8</td><td></td><td>6</td><td>5</td><td></td><td>3</td><td>2</td><td></td></tr> </table>		79	78	77	76	75	74	73	72	71	70	69	68		66	65	64	63	61	60	59	58	57	56			53	52		50						44	43	41	40	39	38	37		35	34		32		30	29		27	26				22	21	20	19	18	17	16			13	12				8		6	5		3	2	
	79	78	77	76	75	74	73	72	71	70	69	68		66	65	64	63	61																																																																			
60	59	58	57	56			53	52		50						44	43	41																																																																			
40	39	38	37		35	34		32		30	29		27	26				22	21																																																																		
20	19	18	17	16			13	12				8		6	5		3	2																																																																			

ENTER DESCRIPTION TEC NO. UAU2010-1551 DRAWN BY CHYKORFF JHS 2008/05/09 CHECKED BY APPR:VKOSHY 2010/03/18	QUALITY SYMBOLS ▽=0 ▽=0	GENERAL TOLERANCES (UNLESS SPECIFIED) mm INCH 4 PLACES ±--- ±--- 3 PLACES ±--- ±--- 2 PLACES ±--- ±--- 1 PLACE ±--- ±--- ANGULAR ±---°	DIMENSION STYLE MM ONLY	SCALE 1:1	DESIGN UNITS METRIC	THIRD ANGLE PROJECTION 	
	DRAWN BY DATE SRAJENDRANAT 2008/05/09	CHECKED BY DATE TSK IVER 2008/05/09	APPROVED BY DATE VKOSHY 2010/03/18	MATERIAL NO. NOT SEE BOM TABLE	DOCUMENT NO. SD-34566-001	TITLE MX123 73/80 CKT HRNS CONN ASSY	SHEET NO. 31 OF 36
	MOLEX INCORPORATED						
	THIS DRAWING CONTAINS INFORMATION THAT IS PROPRIETARY TO MOLEX INCORPORATED AND SHOULD NOT BE USED WITHOUT WRITTEN PERMISSION						

STATUS	GM PART #	MATERIAL #	PART/MATERIAL REVISION	WIRE DRESS OPTION	KEY OPTION	COLOR (TPA)	NUMBERS INDICATE CAVITIES OPEN FOR CIRCUITS																																																																																																														
AVAILABLE	NOT APPLICABLE	34566-2683	G	0	H	ST GRY	<table border="1"> <tr><td></td><td></td><td>78</td><td></td><td></td><td></td><td></td><td></td><td></td><td></td><td>72</td><td>71</td><td>70</td><td>69</td><td>68</td><td>67</td><td>66</td><td>65</td><td>64</td><td>63</td><td>61</td></tr> <tr><td>60</td><td>59</td><td>58</td><td>57</td><td>56</td><td></td><td></td><td></td><td></td><td></td><td>53</td><td>52</td><td>51</td><td>50</td><td>48</td><td>47</td><td></td><td></td><td></td><td>44</td><td>43</td><td>41</td></tr> <tr><td>40</td><td></td><td></td><td>37</td><td></td><td>35</td><td>34</td><td></td><td></td><td></td><td>32</td><td></td><td>30</td><td>29</td><td></td><td>27</td><td>26</td><td></td><td></td><td></td><td>22</td><td>21</td></tr> <tr><td>20</td><td>19</td><td>18</td><td>17</td><td>16</td><td></td><td></td><td></td><td></td><td></td><td>13</td><td>12</td><td></td><td></td><td></td><td>8</td><td>7</td><td>6</td><td>5</td><td>4</td><td>3</td><td>2</td><td>1</td></tr> </table>			78								72	71	70	69	68	67	66	65	64	63	61	60	59	58	57	56						53	52	51	50	48	47				44	43	41	40			37		35	34				32		30	29		27	26				22	21	20	19	18	17	16						13	12				8	7	6	5	4	3	2	1																						
		78								72	71	70	69	68	67	66	65	64	63	61																																																																																																	
60	59	58	57	56						53	52	51	50	48	47				44	43	41																																																																																																
40			37		35	34				32		30	29		27	26				22	21																																																																																																
20	19	18	17	16						13	12				8	7	6	5	4	3	2	1																																																																																															
AVAILABLE	NOT APPLICABLE	34566-2693	G	0	B	ST GRY	<table border="1"> <tr><td></td><td>71</td><td>70</td><td></td><td>68</td><td>66</td><td>65</td><td></td><td></td><td></td><td></td><td></td><td></td><td>60</td><td>59</td><td>58</td><td>57</td><td></td><td></td><td></td><td>54</td><td>53</td></tr> <tr><td></td><td>51</td><td>50</td><td>49</td><td>48</td><td>46</td><td>45</td><td></td><td>43</td><td>42</td><td>41</td><td>40</td><td>39</td><td>38</td><td>37</td><td>36</td><td>35</td><td></td><td></td><td></td><td></td><td>33</td></tr> <tr><td></td><td></td><td></td><td></td><td>32</td><td>31</td><td>30</td><td></td><td></td><td></td><td></td><td>24</td><td>23</td><td>22</td><td></td><td>20</td><td></td><td></td><td></td><td></td><td></td><td></td></tr> <tr><td></td><td></td><td></td><td></td><td>16</td><td>15</td><td></td><td>13</td><td>12</td><td>11</td><td>10</td><td>9</td><td>8</td><td>7</td><td>6</td><td>5</td><td>4</td><td></td><td></td><td></td><td></td><td></td></tr> </table>		71	70		68	66	65							60	59	58	57				54	53		51	50	49	48	46	45		43	42	41	40	39	38	37	36	35					33					32	31	30					24	23	22		20											16	15		13	12	11	10	9	8	7	6	5	4																											
	71	70		68	66	65							60	59	58	57				54	53																																																																																																
	51	50	49	48	46	45		43	42	41	40	39	38	37	36	35					33																																																																																																
				32	31	30					24	23	22		20																																																																																																						
				16	15		13	12	11	10	9	8	7	6	5	4																																																																																																					
AVAILABLE	NOT APPLICABLE	34566-2713	G	0	A	BLACK	<table border="1"> <tr><td></td><td></td><td></td><td>69</td><td>68</td><td></td><td></td><td>65</td><td>64</td><td>63</td><td></td><td>61</td><td>60</td><td>59</td><td>58</td><td></td><td>56</td><td></td><td></td><td></td><td></td><td></td></tr> <tr><td>52</td><td></td><td>50</td><td>49</td><td></td><td>47</td><td></td><td></td><td></td><td></td><td>43</td><td>42</td><td>41</td><td>40</td><td>39</td><td>38</td><td>37</td><td>36</td><td></td><td></td><td>34</td><td>33</td></tr> <tr><td></td><td></td><td></td><td></td><td></td><td>32</td><td>31</td><td>30</td><td>29</td><td>28</td><td>27</td><td>25</td><td>24</td><td>23</td><td></td><td></td><td>20</td><td>19</td><td>18</td><td>17</td><td></td><td></td></tr> <tr><td></td><td></td><td></td><td></td><td></td><td>16</td><td></td><td></td><td>13</td><td>12</td><td>11</td><td>10</td><td>9</td><td></td><td></td><td></td><td></td><td></td><td></td><td></td><td></td><td>1</td></tr> </table>				69	68			65	64	63		61	60	59	58		56						52		50	49		47					43	42	41	40	39	38	37	36			34	33						32	31	30	29	28	27	25	24	23			20	19	18	17								16			13	12	11	10	9									1																						
			69	68			65	64	63		61	60	59	58		56																																																																																																					
52		50	49		47					43	42	41	40	39	38	37	36			34	33																																																																																																
					32	31	30	29	28	27	25	24	23			20	19	18	17																																																																																																		
					16			13	12	11	10	9									1																																																																																																
AVAILABLE	NOT APPLICABLE	34566-2723	G	0	B	ST GRY	<table border="1"> <tr><td></td><td>71</td><td>70</td><td></td><td>68</td><td>66</td><td>65</td><td>64</td><td>63</td><td></td><td></td><td></td><td>60</td><td>59</td><td>58</td><td>57</td><td>56</td><td>55</td><td></td><td></td><td>54</td><td>53</td></tr> <tr><td></td><td>51</td><td>50</td><td>49</td><td>48</td><td>46</td><td>45</td><td></td><td>43</td><td>42</td><td>41</td><td>40</td><td>39</td><td>38</td><td>37</td><td>36</td><td>35</td><td></td><td></td><td></td><td></td><td>33</td></tr> <tr><td></td><td></td><td></td><td></td><td>32</td><td>31</td><td>30</td><td></td><td></td><td></td><td></td><td>24</td><td>23</td><td>22</td><td></td><td>20</td><td>19</td><td></td><td></td><td></td><td></td><td></td></tr> <tr><td></td><td></td><td></td><td></td><td>16</td><td>15</td><td></td><td>13</td><td>12</td><td>11</td><td>10</td><td>9</td><td>8</td><td>7</td><td>6</td><td>5</td><td>4</td><td>3</td><td>2</td><td></td><td></td><td></td></tr> </table>		71	70		68	66	65	64	63				60	59	58	57	56	55			54	53		51	50	49	48	46	45		43	42	41	40	39	38	37	36	35					33					32	31	30					24	23	22		20	19										16	15		13	12	11	10	9	8	7	6	5	4	3	2																									
	71	70		68	66	65	64	63				60	59	58	57	56	55			54	53																																																																																																
	51	50	49	48	46	45		43	42	41	40	39	38	37	36	35					33																																																																																																
				32	31	30					24	23	22		20	19																																																																																																					
				16	15		13	12	11	10	9	8	7	6	5	4	3	2																																																																																																			
AVAILABLE	NOT APPLICABLE	34566-2733	G	0	A	BLACK	<table border="1"> <tr><td></td><td></td><td>70</td><td></td><td>68</td><td>67</td><td>66</td><td>65</td><td></td><td></td><td>44</td><td>43</td><td>42</td><td>41</td><td></td><td></td><td>58</td><td>57</td><td></td><td>55</td><td></td><td></td></tr> <tr><td></td><td></td><td></td><td>49</td><td></td><td>47</td><td></td><td></td><td></td><td></td><td></td><td></td><td></td><td></td><td>39</td><td>37</td><td></td><td></td><td></td><td></td><td></td><td></td></tr> <tr><td></td><td></td><td></td><td></td><td></td><td>32</td><td>31</td><td>30</td><td></td><td></td><td>27</td><td>25</td><td>24</td><td>23</td><td></td><td>21</td><td>20</td><td>19</td><td>18</td><td>17</td><td></td><td></td></tr> <tr><td></td><td></td><td></td><td></td><td></td><td>16</td><td>15</td><td></td><td>13</td><td></td><td>10</td><td>9</td><td>8</td><td>7</td><td>6</td><td>5</td><td></td><td>3</td><td>2</td><td>1</td><td></td><td></td></tr> </table>			70		68	67	66	65			44	43	42	41			58	57		55						49		47									39	37												32	31	30			27	25	24	23		21	20	19	18	17								16	15		13		10	9	8	7	6	5		3	2	1																								
		70		68	67	66	65			44	43	42	41			58	57		55																																																																																																		
			49		47									39	37																																																																																																						
					32	31	30			27	25	24	23		21	20	19	18	17																																																																																																		
					16	15		13		10	9	8	7	6	5		3	2	1																																																																																																		
AVAILABLE	NOT APPLICABLE	34566-2743	G	0	C	BLUE	<table border="1"> <tr><td>72</td><td>70</td><td></td><td></td><td>67</td><td>66</td><td></td><td></td><td>63</td><td>62</td><td></td><td></td><td>59</td><td></td><td>57</td><td></td><td></td><td></td><td></td><td></td><td></td><td>53</td></tr> <tr><td>52</td><td>51</td><td></td><td></td><td></td><td>46</td><td>44</td><td></td><td></td><td>42</td><td></td><td></td><td>40</td><td>39</td><td></td><td></td><td></td><td></td><td></td><td></td><td></td><td>34</td><td>33</td></tr> <tr><td></td><td></td><td></td><td></td><td></td><td>32</td><td>31</td><td>30</td><td></td><td></td><td>26</td><td>25</td><td></td><td></td><td>22</td><td>21</td><td>20</td><td></td><td></td><td></td><td></td><td></td></tr> <tr><td></td><td></td><td></td><td></td><td></td><td>15</td><td>14</td><td></td><td></td><td></td><td>10</td><td>9</td><td></td><td></td><td>6</td><td>5</td><td>4</td><td></td><td></td><td></td><td></td><td></td></tr> </table>	72	70			67	66			63	62			59		57							53	52	51				46	44			42			40	39								34	33						32	31	30			26	25			22	21	20											15	14				10	9			6	5	4																										
72	70			67	66			63	62			59		57							53																																																																																																
52	51				46	44			42			40	39								34	33																																																																																															
					32	31	30			26	25			22	21	20																																																																																																					
					15	14				10	9			6	5	4																																																																																																					
AVAILABLE	NOT APPLICABLE	34566-2753	G	0	A	BLACK	<table border="1"> <tr><td></td><td></td><td></td><td></td><td></td><td></td><td></td><td></td><td></td><td>63</td><td>62</td><td>61</td><td></td><td></td><td>58</td><td>57</td><td>56</td><td>55</td><td>54</td><td>53</td><td></td><td></td></tr> <tr><td>52</td><td>51</td><td></td><td>49</td><td></td><td></td><td></td><td></td><td>44</td><td>43</td><td>42</td><td>41</td><td></td><td></td><td></td><td>37</td><td>36</td><td>35</td><td>34</td><td>33</td><td></td><td></td></tr> <tr><td></td><td></td><td></td><td></td><td></td><td></td><td></td><td></td><td>32</td><td>29</td><td>28</td><td>27</td><td>26</td><td></td><td></td><td></td><td></td><td>19</td><td>18</td><td></td><td></td><td></td></tr> <tr><td></td><td></td><td></td><td></td><td></td><td></td><td></td><td></td><td>16</td><td>15</td><td>14</td><td>13</td><td>12</td><td>11</td><td>10</td><td></td><td></td><td></td><td></td><td></td><td></td><td>3</td></tr> </table>										63	62	61			58	57	56	55	54	53			52	51		49					44	43	42	41				37	36	35	34	33											32	29	28	27	26					19	18												16	15	14	13	12	11	10							3																						
									63	62	61			58	57	56	55	54	53																																																																																																		
52	51		49					44	43	42	41				37	36	35	34	33																																																																																																		
								32	29	28	27	26					19	18																																																																																																			
								16	15	14	13	12	11	10							3																																																																																																
AVAILABLE	NOT APPLICABLE	34566-2763	G	0	B	ST GRY	<table border="1"> <tr><td>72</td><td>71</td><td>70</td><td></td><td>68</td><td>67</td><td>66</td><td></td><td></td><td></td><td>62</td><td>61</td><td>60</td><td>59</td><td>58</td><td>57</td><td>56</td><td>55</td><td>54</td><td>53</td><td></td><td></td></tr> <tr><td>52</td><td>51</td><td>50</td><td></td><td>48</td><td>47</td><td>46</td><td></td><td></td><td></td><td>42</td><td>41</td><td>40</td><td>39</td><td>38</td><td>37</td><td>36</td><td>35</td><td>34</td><td>33</td><td></td><td></td></tr> <tr><td></td><td></td><td></td><td></td><td>32</td><td>31</td><td>30</td><td>29</td><td>28</td><td>27</td><td>26</td><td>25</td><td>24</td><td></td><td></td><td></td><td></td><td></td><td></td><td></td><td></td><td></td></tr> <tr><td></td><td></td><td></td><td></td><td>16</td><td>15</td><td>14</td><td>13</td><td></td><td></td><td>10</td><td>9</td><td>8</td><td></td><td></td><td></td><td></td><td></td><td></td><td></td><td></td><td></td></tr> </table>	72	71	70		68	67	66				62	61	60	59	58	57	56	55	54	53			52	51	50		48	47	46				42	41	40	39	38	37	36	35	34	33							32	31	30	29	28	27	26	25	24														16	15	14	13			10	9	8																															
72	71	70		68	67	66				62	61	60	59	58	57	56	55	54	53																																																																																																		
52	51	50		48	47	46				42	41	40	39	38	37	36	35	34	33																																																																																																		
				32	31	30	29	28	27	26	25	24																																																																																																									
				16	15	14	13			10	9	8																																																																																																									
AVAILABLE	NOT APPLICABLE	34566-2773	G	0	H	ST GRY	<table border="1"> <tr><td></td><td></td><td></td><td></td><td></td><td></td><td></td><td></td><td></td><td></td><td></td><td></td><td></td><td></td><td></td><td></td><td></td><td></td><td></td><td></td><td></td><td>61</td></tr> <tr><td></td><td></td><td></td><td></td><td></td><td></td><td></td><td></td><td></td><td></td><td></td><td></td><td></td><td></td><td></td><td></td><td></td><td></td><td></td><td></td><td></td><td>53</td></tr> <tr><td></td><td></td><td></td><td></td><td></td><td></td><td></td><td></td><td></td><td></td><td></td><td></td><td></td><td></td><td></td><td></td><td></td><td></td><td></td><td></td><td></td><td>32</td></tr> <tr><td>20</td><td></td><td></td><td></td><td></td><td></td><td></td><td></td><td></td><td></td><td></td><td></td><td></td><td>9</td><td></td><td></td><td></td><td></td><td></td><td></td><td></td><td>5</td></tr> <tr><td></td><td></td><td></td><td></td><td></td><td></td><td></td><td></td><td></td><td></td><td></td><td></td><td></td><td></td><td></td><td></td><td></td><td></td><td></td><td></td><td></td><td>1</td></tr> </table>																						61																						53																						32	20													9								5																						1
																					61																																																																																																
																					53																																																																																																
																					32																																																																																																
20													9								5																																																																																																
																					1																																																																																																
AVAILABLE	NOT APPLICABLE	34566-2783	G	9	H	ST GRY	<table border="1"> <tr><td></td><td></td><td></td><td></td><td></td><td></td><td></td><td></td><td></td><td></td><td></td><td></td><td></td><td></td><td></td><td></td><td></td><td></td><td></td><td></td><td></td><td>61</td></tr> <tr><td></td><td></td><td></td><td></td><td></td><td></td><td></td><td></td><td></td><td></td><td></td><td></td><td></td><td></td><td></td><td></td><td></td><td></td><td></td><td></td><td></td><td>53</td></tr> <tr><td></td><td></td><td></td><td></td><td></td><td></td><td></td><td></td><td></td><td></td><td></td><td></td><td></td><td></td><td></td><td></td><td></td><td></td><td></td><td></td><td></td><td>32</td></tr> <tr><td>20</td><td></td><td></td><td></td><td></td><td></td><td></td><td></td><td></td><td></td><td></td><td></td><td></td><td>9</td><td></td><td></td><td></td><td></td><td></td><td></td><td></td><td>5</td></tr> <tr><td></td><td></td><td></td><td></td><td></td><td></td><td></td><td></td><td></td><td></td><td></td><td></td><td></td><td></td><td></td><td></td><td></td><td></td><td></td><td></td><td></td><td>1</td></tr> </table>																						61																						53																						32	20													9								5																						1
																					61																																																																																																
																					53																																																																																																
																					32																																																																																																
20													9								5																																																																																																
																					1																																																																																																

ENTER DESCRIPTION EC NO. UAU2010-1551 DRAWN BY 2010/03/15 CHKD BY FFJHS 2008/05/09 APPR: VKOSHY 2010/03/18	QUALITY SYMBOLS ▽=0 ▽=0	GENERAL TOLERANCES (UNLESS SPECIFIED)		DIMENSION STYLE MM ONLY	SCALE 1:1	DESIGN UNITS METRIC	THIRD ANGLE PROJECTION	
		4 PLACES ± --- ± --- 3 PLACES ± --- ± --- 2 PLACES ± --- ± --- 1 PLACE ± --- ± ---	mm INCH	DRAWN BY SRAJENDRANAT	DATE 2008/05/09	TITLE MX123 73/80 CKT HRNS CONN ASSY		
		DRAFT WHERE APPLICABLE MUST REMAIN WITHIN DIMENSIONS		APPROVED BY VKOSHY	DATE 2010/03/18	MOLEX INCORPORATED		
		SEE BOM TABLE		MATERIAL NO.	DOCUMENT NO.	SD-34566-001		

THIS DRAWING CONTAINS INFORMATION THAT IS PROPRIETARY TO MOLEX INCORPORATED AND SHOULD NOT BE USED WITHOUT WRITTEN PERMISSION

STATUS	GM PART #	MATERIAL #	PART/MATERIAL REVISION	WIRE DRESS OPTION	KEY OPTION	COLOR (TPA)	NUMBERS INDICATE CAVITIES OPEN FOR CIRCUITS																																																																													
AVAILABLE	NOT APPLICABLE	34566-2893	G	0	A	BLACK	<table border="1"> <tr><td>72</td><td></td><td>69</td><td>67</td><td>65</td><td>63</td><td></td><td>60</td><td></td><td>57</td><td>56</td><td></td><td>53</td></tr> <tr><td></td><td></td><td>49</td><td>47</td><td>46</td><td>44</td><td>43</td><td></td><td>40</td><td></td><td>37</td><td>36</td><td>35</td><td>33</td></tr> <tr><td></td><td>73</td><td></td><td>31</td><td>30</td><td>29</td><td>28</td><td></td><td>24</td><td></td><td>21</td><td>20</td><td></td><td>17</td></tr> <tr><td></td><td></td><td>16</td><td>15</td><td>14</td><td>13</td><td></td><td>11</td><td>10</td><td></td><td></td><td>5</td><td>4</td><td>3</td><td>2</td><td>1</td></tr> </table>	72		69	67	65	63		60		57	56		53			49	47	46	44	43		40		37	36	35	33		73		31	30	29	28		24		21	20		17			16	15	14	13		11	10			5	4	3	2	1																				
72		69	67	65	63		60		57	56		53																																																																								
		49	47	46	44	43		40		37	36	35	33																																																																							
	73		31	30	29	28		24		21	20		17																																																																							
		16	15	14	13		11	10			5	4	3	2	1																																																																					
AVAILABLE	NOT APPLICABLE	34566-2913	G	0	B	ST GRAY	<table border="1"> <tr><td></td><td></td><td></td><td>68</td><td>67</td><td></td><td>64</td><td></td><td></td><td></td><td></td><td></td><td></td><td>58</td><td></td><td></td><td></td><td></td></tr> <tr><td></td><td></td><td></td><td></td><td></td><td>46</td><td>45</td><td></td><td></td><td></td><td></td><td></td><td></td><td>38</td><td></td><td></td><td></td><td></td></tr> <tr><td></td><td>73</td><td></td><td>32</td><td></td><td>30</td><td>29</td><td>28</td><td>27</td><td></td><td></td><td></td><td></td><td>22</td><td></td><td></td><td></td><td>17</td></tr> <tr><td></td><td></td><td></td><td></td><td>15</td><td>13</td><td></td><td></td><td>10</td><td></td><td></td><td></td><td></td><td></td><td></td><td></td><td></td><td>1</td></tr> </table>				68	67		64							58										46	45							38						73		32		30	29	28	27					22				17					15	13			10									1					
			68	67		64							58																																																																							
					46	45							38																																																																							
	73		32		30	29	28	27					22				17																																																																			
				15	13			10									1																																																																			
AVAILABLE	NOT APPLICABLE	34566-2923	G	0	B	ST GRAY	<table border="1"> <tr><td></td><td></td><td></td><td>68</td><td>67</td><td></td><td>64</td><td></td><td></td><td></td><td></td><td></td><td></td><td></td><td></td><td></td><td></td><td></td></tr> <tr><td></td><td></td><td></td><td></td><td></td><td>46</td><td>45</td><td></td><td></td><td></td><td></td><td></td><td></td><td></td><td></td><td></td><td></td><td></td></tr> <tr><td></td><td>73</td><td></td><td>32</td><td></td><td>30</td><td>29</td><td>28</td><td>27</td><td></td><td></td><td></td><td></td><td></td><td></td><td></td><td></td><td>17</td></tr> <tr><td></td><td></td><td></td><td></td><td>15</td><td>13</td><td></td><td></td><td>10</td><td></td><td></td><td></td><td></td><td></td><td></td><td></td><td></td><td></td></tr> </table>				68	67		64																	46	45													73		32		30	29	28	27									17					15	13			10														
			68	67		64																																																																														
					46	45																																																																														
	73		32		30	29	28	27									17																																																																			
				15	13			10																																																																												
AVAILABLE	NOT APPLICABLE	34566-2933	G	0	A	BLACK	<table border="1"> <tr><td>72</td><td></td><td>69</td><td>67</td><td>65</td><td>63</td><td></td><td>60</td><td></td><td>57</td><td>56</td><td></td><td>53</td></tr> <tr><td></td><td></td><td>49</td><td>47</td><td></td><td>44</td><td>43</td><td></td><td>40</td><td></td><td>37</td><td>36</td><td>35</td><td>33</td></tr> <tr><td></td><td>73</td><td></td><td>31</td><td>30</td><td>29</td><td>28</td><td></td><td>24</td><td></td><td>21</td><td>20</td><td></td><td>17</td></tr> <tr><td></td><td></td><td>16</td><td>15</td><td>14</td><td></td><td></td><td>11</td><td>10</td><td></td><td></td><td></td><td>5</td><td>4</td><td>3</td><td>2</td><td>1</td></tr> </table>	72		69	67	65	63		60		57	56		53			49	47		44	43		40		37	36	35	33		73		31	30	29	28		24		21	20		17			16	15	14			11	10				5	4	3	2	1																			
72		69	67	65	63		60		57	56		53																																																																								
		49	47		44	43		40		37	36	35	33																																																																							
	73		31	30	29	28		24		21	20		17																																																																							
		16	15	14			11	10				5	4	3	2	1																																																																				
AVAILABLE	NOT APPLICABLE	34566-2943	G	0	B	ST GRAY	<table border="1"> <tr><td></td><td></td><td></td><td>68</td><td>67</td><td></td><td>64</td><td>63</td><td></td><td></td><td>59</td><td>57</td><td></td><td></td><td></td><td></td><td></td><td></td></tr> <tr><td></td><td></td><td></td><td></td><td></td><td>46</td><td>45</td><td>43</td><td></td><td></td><td>39</td><td>37</td><td></td><td></td><td></td><td></td><td></td><td></td></tr> <tr><td></td><td></td><td></td><td>32</td><td></td><td>30</td><td>29</td><td>28</td><td>27</td><td></td><td></td><td></td><td>21</td><td></td><td></td><td></td><td></td><td></td></tr> <tr><td></td><td></td><td></td><td></td><td></td><td></td><td></td><td></td><td>10</td><td></td><td></td><td></td><td>6</td><td>5</td><td>4</td><td>3</td><td></td><td></td></tr> </table>				68	67		64	63			59	57												46	45	43			39	37										32		30	29	28	27				21														10				6	5	4	3							
			68	67		64	63			59	57																																																																									
					46	45	43			39	37																																																																									
			32		30	29	28	27				21																																																																								
								10				6	5	4	3																																																																					
AVAILABLE	NOT APPLICABLE	34566-2953	G	0	B	ST GRAY	<table border="1"> <tr><td></td><td></td><td></td><td>68</td><td>67</td><td></td><td>64</td><td>63</td><td></td><td></td><td>59</td><td></td><td></td><td></td><td></td><td></td><td></td><td></td></tr> <tr><td></td><td></td><td></td><td></td><td></td><td>46</td><td>45</td><td>43</td><td></td><td></td><td>39</td><td></td><td></td><td></td><td></td><td></td><td>34</td><td></td></tr> <tr><td></td><td></td><td></td><td>32</td><td></td><td>30</td><td>29</td><td>28</td><td>27</td><td></td><td></td><td></td><td></td><td></td><td></td><td></td><td></td><td></td></tr> <tr><td></td><td></td><td></td><td></td><td></td><td></td><td></td><td></td><td>10</td><td></td><td></td><td></td><td>6</td><td>5</td><td>4</td><td>3</td><td></td><td></td></tr> </table>				68	67		64	63			59													46	45	43			39						34					32		30	29	28	27																		10				6	5	4	3							
			68	67		64	63			59																																																																										
					46	45	43			39						34																																																																				
			32		30	29	28	27																																																																												
								10				6	5	4	3																																																																					
AVAILABLE	NOT APPLICABLE	34566-2963	G	0	H	ST GRAY	<table border="1"> <tr><td></td><td>79</td><td></td><td></td><td></td><td>74</td><td>73</td><td>72</td><td>71</td><td></td><td>69</td><td>68</td><td>67</td><td></td><td></td><td>64</td><td></td><td>62</td><td>61</td></tr> <tr><td></td><td>59</td><td></td><td></td><td></td><td>54</td><td>53</td><td>52</td><td></td><td></td><td>49</td><td>48</td><td>47</td><td></td><td></td><td></td><td></td><td>42</td><td>41</td></tr> <tr><td></td><td></td><td>38</td><td></td><td></td><td></td><td></td><td>33</td><td></td><td></td><td>29</td><td>27</td><td></td><td></td><td>25</td><td></td><td></td><td></td><td>21</td></tr> <tr><td></td><td></td><td></td><td></td><td></td><td>15</td><td>14</td><td></td><td></td><td>11</td><td>10</td><td>9</td><td>8</td><td>7</td><td></td><td></td><td></td><td></td><td></td></tr> </table>		79				74	73	72	71		69	68	67			64		62	61		59				54	53	52			49	48	47					42	41			38					33			29	27			25				21						15	14			11	10	9	8	7						
	79				74	73	72	71		69	68	67			64		62	61																																																																		
	59				54	53	52			49	48	47					42	41																																																																		
		38					33			29	27			25				21																																																																		
					15	14			11	10	9	8	7																																																																							
AVAILABLE	NOT APPLICABLE	34566-2973	G	0	G	BLUE	<table border="1"> <tr><td>80</td><td>78</td><td>77</td><td>76</td><td>75</td><td>74</td><td>73</td><td>72</td><td></td><td>70</td><td>69</td><td>67</td><td></td><td>65</td><td>64</td><td>63</td><td>62</td><td></td><td></td></tr> <tr><td>60</td><td>58</td><td>57</td><td>56</td><td>55</td><td>54</td><td></td><td>52</td><td>51</td><td>50</td><td>49</td><td>47</td><td></td><td>45</td><td></td><td></td><td></td><td></td><td></td></tr> <tr><td>40</td><td>38</td><td>37</td><td></td><td></td><td></td><td></td><td>33</td><td>32</td><td>31</td><td></td><td></td><td>27</td><td>26</td><td>25</td><td>24</td><td></td><td></td><td></td></tr> <tr><td>20</td><td>18</td><td>17</td><td></td><td></td><td></td><td></td><td></td><td></td><td></td><td>10</td><td>9</td><td>8</td><td></td><td>6</td><td>5</td><td></td><td>3</td><td>2</td><td>1</td></tr> </table>	80	78	77	76	75	74	73	72		70	69	67		65	64	63	62			60	58	57	56	55	54		52	51	50	49	47		45						40	38	37					33	32	31			27	26	25	24				20	18	17								10	9	8		6	5		3	2	1
80	78	77	76	75	74	73	72		70	69	67		65	64	63	62																																																																				
60	58	57	56	55	54		52	51	50	49	47		45																																																																							
40	38	37					33	32	31			27	26	25	24																																																																					
20	18	17								10	9	8		6	5		3	2	1																																																																	

ENTER DESCRIPTION TEC NO: JAU2010-1551 DRAWN BY: 2010/03/15 CHKD: GRIFFITHS 2008/05/09 APPR: VKOSHY 2010/03/18	QUALITY SYMBOLS	GENERAL TOLERANCES (UNLESS SPECIFIED)	DIMENSION STYLE	SCALE	DESIGN UNITS	THIRD ANGLE PROJECTION	
	∇=0 ∇=0 ∇=0	mm INCH 4 PLACES ± --- ± --- 3 PLACES ± --- ± --- 2 PLACES ± --- ± --- 1 PLACE ± --- ± ---	MM ONLY	2:1	METRIC	DRAWN BY: SRAJENDRANAT 2008/05/09 CHECKED BY: TSK IVER 2008/05/09 APPROVED BY: VKOSHY 2010/03/18	TITLE: MX123 73/80 CKT HRNS CONN ASSY
	DRAFT WHERE APPLICABLE MUST REMAIN WITHIN DIMENSIONS	ANGULAR ± ---°	SEE BOM TABLE	MATERIAL NO.	DOCUMENT NO.	MOLEX INCORPORATED	SHEET NO. 34 OF 36
			SIZE D	SD-34566-001		THIS DRAWING CONTAINS INFORMATION THAT IS PROPRIETARY TO MOLEX INCORPORATED AND SHOULD NOT BE USED WITHOUT WRITTEN PERMISSION	

STATUS	GM PART #	MATERIAL #	PART / MATERIAL REVISION	WIRE DRESS OPTION	KEY OPTION	COLOR (TPA)	NUMBERS INDICATE CAVITIES OPEN FOR CIRCUITS																																																																																																																															
AVAILABLE	NOT APPLICABLE	34566-9913	G	0	A	BLACK	<table border="1"> <tr><td>72</td><td>71</td><td></td><td></td><td>68</td><td>67</td><td>66</td><td>65</td><td>64</td><td></td><td></td><td></td><td></td><td></td><td></td><td>59</td><td></td><td></td><td></td><td></td><td></td></tr> <tr><td></td><td></td><td>50</td><td></td><td>48</td><td>47</td><td>46</td><td>45</td><td></td><td></td><td></td><td></td><td></td><td></td><td></td><td>40</td><td>39</td><td>38</td><td></td><td></td><td></td></tr> <tr><td></td><td></td><td></td><td></td><td>31</td><td>30</td><td></td><td></td><td></td><td></td><td></td><td></td><td></td><td></td><td>25</td><td>24</td><td></td><td>22</td><td>21</td><td>20</td><td></td></tr> <tr><td></td><td></td><td></td><td></td><td></td><td></td><td>14</td><td></td><td></td><td></td><td></td><td></td><td></td><td></td><td></td><td>9</td><td>7</td><td>6</td><td>5</td><td>4</td><td></td></tr> <tr><td></td><td></td><td></td><td></td><td></td><td></td><td></td><td></td><td></td><td></td><td></td><td></td><td></td><td></td><td></td><td></td><td></td><td></td><td></td><td>2</td><td>1</td></tr> </table>	72	71			68	67	66	65	64							59								50		48	47	46	45								40	39	38								31	30									25	24		22	21	20								14									9	7	6	5	4																					2	1																						
72	71			68	67	66	65	64							59																																																																																																																							
		50		48	47	46	45								40	39	38																																																																																																																					
				31	30									25	24		22	21	20																																																																																																																			
						14									9	7	6	5	4																																																																																																																			
																			2	1																																																																																																																		
AVAILABLE	NOT APPLICABLE	34566-9923	G	0	A	BLACK	<table border="1"> <tr><td>72</td><td>71</td><td></td><td></td><td></td><td>67</td><td>66</td><td></td><td></td><td></td><td>62</td><td>61</td><td>60</td><td></td><td></td><td>57</td><td></td><td></td><td>55</td><td>54</td></tr> <tr><td></td><td>51</td><td></td><td></td><td></td><td>48</td><td>46</td><td>45</td><td>44</td><td>43</td><td>42</td><td></td><td></td><td></td><td></td><td>39</td><td></td><td></td><td></td><td>35</td><td>33</td></tr> <tr><td></td><td></td><td></td><td></td><td></td><td></td><td>15</td><td>14</td><td></td><td></td><td></td><td></td><td></td><td></td><td></td><td>8</td><td>7</td><td>6</td><td>5</td><td>4</td><td></td></tr> <tr><td></td><td></td><td></td><td></td><td></td><td></td><td></td><td></td><td></td><td></td><td></td><td></td><td></td><td></td><td></td><td></td><td></td><td></td><td></td><td>3</td><td>2</td></tr> </table>	72	71				67	66				62	61	60			57			55	54		51				48	46	45	44	43	42					39				35	33							15	14								8	7	6	5	4																					3	2																																												
72	71				67	66				62	61	60			57			55	54																																																																																																																			
	51				48	46	45	44	43	42					39				35	33																																																																																																																		
						15	14								8	7	6	5	4																																																																																																																			
																			3	2																																																																																																																		
AVAILABLE	NOT APPLICABLE	34566-9933	G	0	B	ST GRY	<table border="1"> <tr><td></td><td></td><td></td><td>69</td><td></td><td></td><td>65</td><td>64</td><td>63</td><td></td><td></td><td></td><td></td><td></td><td></td><td></td><td></td><td></td><td></td><td></td><td></td></tr> <tr><td></td><td></td><td></td><td>49</td><td></td><td></td><td>45</td><td>44</td><td>43</td><td></td><td></td><td></td><td></td><td></td><td></td><td></td><td></td><td></td><td></td><td></td><td></td></tr> <tr><td></td><td></td><td></td><td></td><td></td><td></td><td></td><td></td><td></td><td></td><td></td><td></td><td></td><td></td><td></td><td></td><td></td><td></td><td>22</td><td>21</td><td>20</td></tr> <tr><td></td><td></td><td></td><td></td><td></td><td></td><td></td><td></td><td></td><td></td><td></td><td></td><td></td><td></td><td></td><td></td><td></td><td></td><td>19</td><td>18</td><td>17</td></tr> <tr><td></td><td></td><td></td><td></td><td></td><td></td><td></td><td></td><td></td><td></td><td></td><td></td><td></td><td></td><td></td><td></td><td></td><td></td><td>6</td><td>5</td><td>4</td></tr> <tr><td></td><td></td><td></td><td></td><td></td><td></td><td></td><td></td><td></td><td></td><td></td><td></td><td></td><td></td><td></td><td></td><td></td><td></td><td></td><td>3</td><td>2</td><td>1</td></tr> </table>				69			65	64	63																49			45	44	43																															22	21	20																			19	18	17																			6	5	4																				3	2	1
			69			65	64	63																																																																																																																														
			49			45	44	43																																																																																																																														
																		22	21	20																																																																																																																		
																		19	18	17																																																																																																																		
																		6	5	4																																																																																																																		
																			3	2	1																																																																																																																	
AVAILABLE	NOT APPLICABLE	34566-9943	G	0	C	BLUE	<table border="1"> <tr><td></td><td>71</td><td></td><td>69</td><td></td><td></td><td>65</td><td>64</td><td></td><td></td><td>61</td><td>60</td><td></td><td></td><td>58</td><td></td><td></td><td>56</td><td>55</td><td>54</td></tr> <tr><td></td><td></td><td>50</td><td>49</td><td></td><td></td><td>45</td><td>43</td><td>41</td><td></td><td></td><td></td><td></td><td></td><td></td><td></td><td>37</td><td>36</td><td>35</td><td></td></tr> <tr><td></td><td></td><td></td><td></td><td></td><td>31</td><td>29</td><td>28</td><td></td><td></td><td>24</td><td>23</td><td></td><td></td><td></td><td></td><td></td><td></td><td>19</td><td>18</td><td>17</td></tr> <tr><td></td><td></td><td></td><td></td><td></td><td>16</td><td></td><td>13</td><td>12</td><td>11</td><td></td><td>8</td><td>7</td><td></td><td></td><td></td><td></td><td></td><td></td><td>3</td><td>2</td><td>1</td></tr> </table>		71		69			65	64			61	60			58			56	55	54			50	49			45	43	41								37	36	35							31	29	28			24	23							19	18	17						16		13	12	11		8	7							3	2	1																																												
	71		69			65	64			61	60			58			56	55	54																																																																																																																			
		50	49			45	43	41								37	36	35																																																																																																																				
					31	29	28			24	23							19	18	17																																																																																																																		
					16		13	12	11		8	7							3	2	1																																																																																																																	
AVAILABLE	NOT APPLICABLE	34566-9953	G	0	A	BLACK	<table border="1"> <tr><td></td><td></td><td></td><td></td><td></td><td>67</td><td></td><td></td><td></td><td>62</td><td></td><td>60</td><td></td><td></td><td>57</td><td></td><td></td><td>55</td><td></td><td></td></tr> <tr><td></td><td></td><td></td><td></td><td></td><td>51</td><td></td><td>48</td><td>46</td><td>45</td><td>44</td><td>43</td><td></td><td></td><td></td><td>39</td><td></td><td></td><td>35</td><td></td></tr> <tr><td></td><td></td><td></td><td></td><td></td><td></td><td></td><td></td><td></td><td></td><td></td><td></td><td>25</td><td></td><td></td><td></td><td></td><td></td><td></td><td></td></tr> <tr><td></td><td></td><td></td><td></td><td></td><td></td><td></td><td></td><td></td><td></td><td></td><td></td><td></td><td></td><td></td><td>7</td><td>6</td><td>5</td><td>4</td><td>3</td><td>2</td></tr> </table>						67				62		60			57			55								51		48	46	45	44	43				39			35														25																							7	6	5	4	3	2																																														
					67				62		60			57			55																																																																																																																					
					51		48	46	45	44	43				39			35																																																																																																																				
												25																																																																																																																										
															7	6	5	4	3	2																																																																																																																		
AVAILABLE	NOT APPLICABLE	34566-9963	G	0	B	ST GRY	<table border="1"> <tr><td></td><td></td><td></td><td></td><td>68</td><td>67</td><td></td><td></td><td>64</td><td>63</td><td></td><td></td><td></td><td></td><td>58</td><td></td><td></td><td>55</td><td></td><td></td></tr> <tr><td></td><td></td><td></td><td></td><td></td><td></td><td></td><td>46</td><td>45</td><td>43</td><td></td><td></td><td></td><td></td><td>38</td><td></td><td></td><td>35</td><td></td><td></td></tr> <tr><td></td><td></td><td></td><td>73</td><td></td><td>32</td><td></td><td>30</td><td>29</td><td>28</td><td>27</td><td></td><td></td><td></td><td>22</td><td></td><td></td><td>19</td><td>17</td><td></td></tr> <tr><td></td><td></td><td></td><td></td><td></td><td>15</td><td></td><td>13</td><td></td><td></td><td>10</td><td></td><td></td><td></td><td></td><td></td><td></td><td></td><td></td><td></td><td>1</td></tr> </table>					68	67			64	63					58			55										46	45	43					38			35						73		32		30	29	28	27				22			19	17							15		13			10										1																																														
				68	67			64	63					58			55																																																																																																																					
							46	45	43					38			35																																																																																																																					
			73		32		30	29	28	27				22			19	17																																																																																																																				
					15		13			10										1																																																																																																																		
AVAILABLE	NOT APPLICABLE	34566-9973	G	0	B	ST GRY	<table border="1"> <tr><td></td><td></td><td></td><td></td><td>68</td><td>67</td><td></td><td></td><td>64</td><td>63</td><td></td><td></td><td></td><td></td><td>58</td><td></td><td></td><td></td><td></td><td></td></tr> <tr><td></td><td></td><td></td><td></td><td></td><td></td><td></td><td>46</td><td>45</td><td>43</td><td></td><td></td><td></td><td></td><td>38</td><td></td><td></td><td></td><td></td><td></td></tr> <tr><td></td><td></td><td></td><td></td><td>32</td><td></td><td></td><td>30</td><td>29</td><td>28</td><td>27</td><td></td><td></td><td></td><td>22</td><td></td><td></td><td></td><td></td><td></td><td>17</td></tr> <tr><td></td><td></td><td></td><td></td><td></td><td>15</td><td></td><td>13</td><td></td><td></td><td>10</td><td></td><td></td><td></td><td></td><td></td><td></td><td></td><td></td><td></td><td></td></tr> </table>					68	67			64	63					58													46	45	43					38										32			30	29	28	27				22						17						15		13			10																																																							
				68	67			64	63					58																																																																																																																								
							46	45	43					38																																																																																																																								
				32			30	29	28	27				22						17																																																																																																																		
					15		13			10																																																																																																																												

ENTER DESCRIPTION TEC NO: JAU2010-1551 DRAWN BY: 2010/03/15 CHKD:DRFF HS 2008/05/09 APPR:VKOSHY 2010/03/18 T40 REV	QUALITY SYMBOLS ∇=0 ∇=0 ∇=0	GENERAL TOLERANCES (UNLESS SPECIFIED) <table border="1"> <tr><th></th><th>mm</th><th>INCH</th></tr> <tr><td>4 PLACES</td><td>±---</td><td>±---</td></tr> <tr><td>3 PLACES</td><td>±---</td><td>±---</td></tr> <tr><td>2 PLACES</td><td>±---</td><td>±---</td></tr> <tr><td>1 PLACE</td><td>±---</td><td>±---</td></tr> </table> ANGULAR ±----°		mm	INCH	4 PLACES	±---	±---	3 PLACES	±---	±---	2 PLACES	±---	±---	1 PLACE	±---	±---	DIMENSION STYLE MM ONLY	SCALE 1:1	DESIGN UNITS METRIC	THIRD ANGLE PROJECTION
		mm	INCH																		
	4 PLACES	±---	±---																		
	3 PLACES	±---	±---																		
2 PLACES	±---	±---																			
1 PLACE	±---	±---																			
DRAWN BY: SRAJENDRANAT DATE: 2008/05/09 CHECKED BY: TSK IVER DATE: 2008/05/09 APPROVED BY: VKOSHY DATE: 2010/03/18	MATERIAL NO: SEE BOM TABLE	TITLE MX123 73/80 CKT HRNS CONN ASSY	MOLEX INCORPORATED	SHEET NO. 35 OF 36																	
DRAFT WHERE APPLICABLE MUST REMAIN WITHIN DIMENSIONS		MATERIAL NO. SD-34566-001		DOCUMENT NO.		THIS DRAWING CONTAINS INFORMATION THAT IS PROPRIETARY TO MOLEX INCORPORATED AND SHOULD NOT BE USED WITHOUT WRITTEN PERMISSION															
MOLEX INCORPORATED																					

