

PLEASE CHECK WWW.MOLEX.COM FOR LATEST PART INFORMATION

Part Number: [0345661803](#)
Status: **Active**
Overview: [mx123 sealed connection systems](#)
Description: 2.54mm (.100") Pitch, MX123 Female Receptacle Housing, Keying Option F, Wire Dress Option 9, 73 Circuits, Natural TPA

Documents:

[Drawing \(PDF\)](#) [RoHS Certificate of Compliance \(PDF\)](#)
[Product Specification PS-34566-0000 \(PDF\)](#)

General

Product Family	Crimp Housings
Series	34566
Comments	See Sales Drawing for number of Open Circuits
Overview	mx123 sealed connection systems
Product Name	MX123

Physical

Circuits (maximum)	73
Circuits Detail	73
Color - Resin	Natural
Gender	Female
Glow-Wire Compliant	No
Keying to Mating Part	Yes
Lock to Mating Part	Yes
Material - Resin	Nylon
Number of Rows	4
Packaging Type	Tray
Panel Mount	No
Pitch - Mating Interface (in)	0.100 In
Pitch - Mating Interface (mm)	2.54 mm
Pitch - Term. Interface (in)	0.100 In
Pitch - Term. Interface (mm)	2.54 mm
Polarized to Mating Part	Yes
Stackable	No
Temperature Range - Operating	-40°C to +125°C

Electrical

Current - Maximum per Contact	11A, 25A
-------------------------------	----------

Material Info

Reference - Drawing Numbers

Application Specification	AS-34566-001
Product Specification	PS-34566-0000

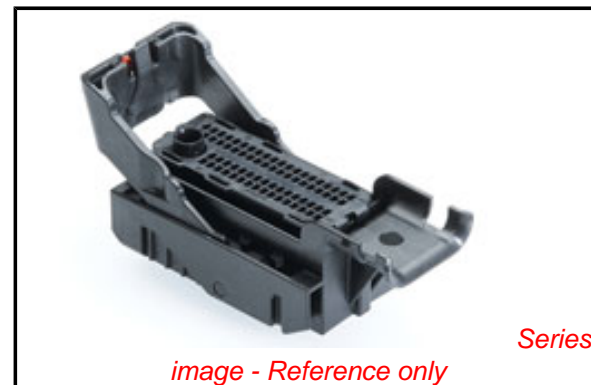

EU RoHS

ELV and RoHS Compliant
REACH SVHC
 Not Reviewed
Halogen-Free
Status
Not Reviewed

China RoHS



Need more information on product environmental compliance?

Email productcompliance@molex.com
 For a multiple part number RoHS Certificate of Compliance, [click here](#)

Please visit the [Contact Us](#) section for any non-product compliance questions.

Search Parts in this Series

[34566Series](#)

Mates With

MX123 Female Header [31386](#) , [31387](#)

Use With

MX64 Female Terminals [33467](#)

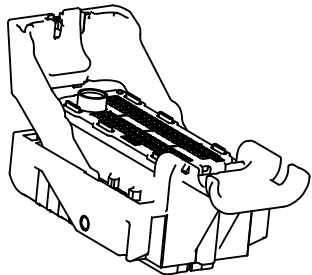

73 CKT
SCALE 3:2

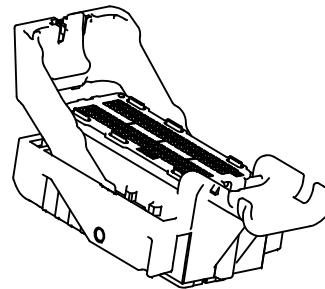
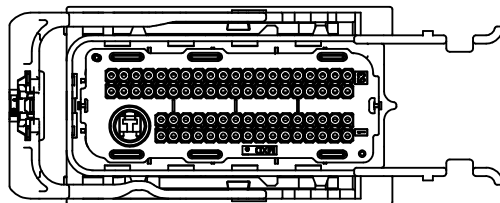

80 CKT
SCALE 3:2

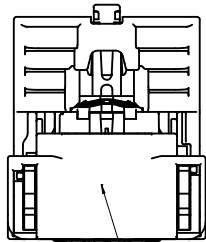

RECOMMENDED LOCATION
FOR NOTE 2D

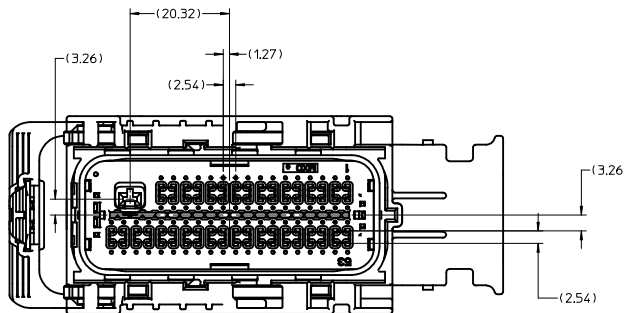
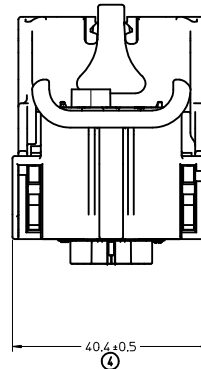
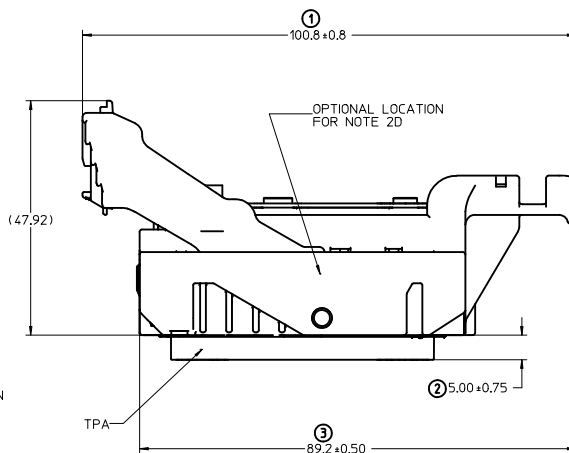

NOTES: UNLESS OTHERWISE SPECIFIED

1. MATERIAL:

- A. RESIN: SEE COMPONENT DRAWINGS
- B. COLOR: SEE TABLE

2. DESIGN - GENERAL:

- A. THIS IS A 100% CAD GENERATED PART. THE CAD MATHEMATICAL DATA IS THE MASTER FOR THIS PART. FOR DIMENSIONAL OR ANY INFORMATION NOT SHOWN ON THIS DRAWING, ANALYZE THE CAD MODEL.
- B. TOLERANCES:
 - a. LINEAR XX ± 0.30
 - XXX ± 0.10
 - XXXX ± 0.10
 - b. ANGULAR X° ± 3.0°
- C. CORNERS SHOWN AS SHARP TO BE R 0.2 MAX.
- D. FOLLOWING PRODUCTION CODES TO BE PERMANENTLY MARKED & HUMAN READABLE TO A LETTER HEIGHT < 3mm.
 - LINE #1: MATERIAL #: XXXX-XXXX
 - LINE #2: DATE CODE: JJYY (JULIAN DAY, LAST DIGIT OF YEAR)
 - LINE #3: INSPECTION MACHINE CODE # SERIAL #X_XXXX
- E-1. PARTS MUST BE FREE OF DISCOLORATION, SALT RESIDUE AND OTHER IMPERFECTIONS THAT AFFECT FIT OR FUNCTION.
- E-2. SCRATCHES OR DENTS NOT TO EXCEED 0.10mm IN DEPTH.
- F. CHANGES IN DESIGN FROM PART PREVIOUSLY APPROVED REQUIRES PRIOR ENGINEERING APPROVAL. THIS INCLUDES BUT IS NOT LIMITED TO DRAFT, MATERIAL OR PROCESSING.
- G. SHALL CONFORM TO THE FOLLOWING PACKAGING SPECIFICATION 300-019

3. DESIGN - MANUFACTURING:

- A. DRAFT TO BE WITHIN TOLERANCE.
- B. ALLOWABLE FLASH 0.2 MAX HIGH X 0.13 MAX THICK.
- C. ALLOWABLE PARTING LINE MISMATCH 0.2 MAX.
- D. EJECTOR PINS MARK TO BE FLUSH TO 0.25 MAX DEPRESSED.
- E. ALLOWABLE GATE VESTIGE TO BE FLUSH TO 0.25 MAX PROTRUSION.

4. SYSTEM REQUIREMENTS:

WHEN TESTED TO SAE/USCAR-2 REV. 3, APRIL 2001, AND GMW #3191, AUGUST 22, 2000 (DRAFT).

- A. TPA (WITHOUT TERMINALS)
 - a. INSERTION FORCE FROM PRE-SET TO LOCK: ≥20
 - b. REMOVAL FORCE FROM PRE-SET: ≥20
- B. CPA
 - a. INSERTION FORCE FROM PRE-SET TO LOCK WITH CONNECTOR UN-MATED: ≥60N
 - b. REMOVAL FORCE FROM PRE-SET: ≥30N
- C. GROMMET CAP
 - a. REMOVAL FORCE FROM HOUSING WITH ENGAGED LATCHES: ≥110N
- D. MATE ASSIST LEVER
 - a. INADVERTENT ACTUATION FORCE DURING SHIPPING, HANDLING OR PRE-ASSEMBLY: ≥190N

F40	REVISED DRAWING---CIRCUIT 73 IS OPEN ON MATERIAL NUMBER 34566-2983
F39	ADD PART NUMBERS
F38	ADD PART NUMBERS
F37	ADD PART NUMBERS
F36	ADD PART NUMBERS
F35	ADD PART NUMBERS
F34	ADD PART NUMBERS
F33	ADD PART NUMBERS
F32	ADD PART NUMBERS & SHEET 33
F31	ADD PART NUMBERS
F30	ASSY # 34566-2683---KEY OPT H WAS A. COLOR ST BRY WAS BLACK
F29	ADD PART NUMBERS
REV	DESCRIPTION

ENTER DESCRIPTION DEC NO: UAU2010-1551 DRAWN BY: 2010/03/15 CHYK/DGR/FFH/THS 2008/05/09 APPROV: VKOSHY 2010/03/18	QUALITY SYMBOLS ▽=0 ▽=0	GENERAL TOLERANCES (UNLESS SPECIFIED)		DIMENSION STYLE MM ONLY		SCALE 2:1	DESIGN UNITS METRIC	THIRD ANGLE PROJECTION		
		4 PLACES ±---+--- 3 PLACES ±---+--- 2 PLACES ±---+--- 1 PLACE ±---+---	mm INCH	DRAWN BY SRAJENDRANAT	DATE 2008/05/09	CHECKED BY TSKIVER	DATE 2008/05/09	TITLE MX123 73/80 CKT HRNS CONN ASSY		
		ANGULAR ±---°		APPROVED BY VKOSHY	DATE 2010/03/18	MATERIAL NO. SEE BOM TABLE		DOCUMENT NO. SD-34566-001		SHEET NO. 1 OF 36
		DRAFT WHERE APPLICABLE MUST REMAIN WITHIN DIMENSIONS		THIS DRAWING CONTAINS INFORMATION THAT IS PROPRIETARY TO MOLEX INCORPORATED AND SHOULD NOT BE USED WITHOUT WRITTEN PERMISSION						

20 19 18 17 16 15 14 13 12 11 10 9 8 7 6 5 4 3 2 1

WIRE DRESS OPTION 0
HOUSING ONLY, SHOWN FOR CLARITY

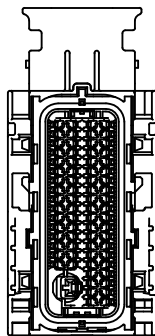

73 CKT
KEY OPTION A

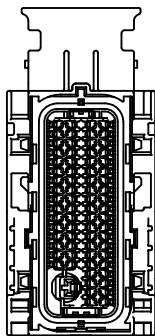

73 CKT
KEY OPTION B

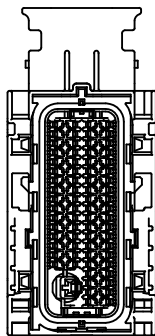

73 CKT
KEY OPTION C

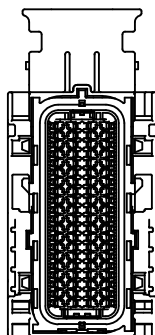

80 CKT
KEY OPTION G

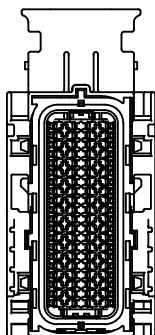

80 CKT
KEY OPTION H

ENTER DESCRIPTION REC NO: UAU2010-1551 DRAWN BY: 2010/03/15 CHYKORRFF/HS 2008/05/09 APPR:VKOSHY 2010/03/18 T40 REV:	QUALITY SYMBOLS ▽=0 ▽=0	GENERAL TOLERANCES (UNLESS SPECIFIED) <table border="1"> <thead> <tr> <th></th> <th>mm</th> <th>INCH</th> </tr> </thead> <tbody> <tr> <td>4 PLACES</td> <td>±---</td> <td>±---</td> </tr> <tr> <td>3 PLACES</td> <td>±---</td> <td>±---</td> </tr> <tr> <td>2 PLACES</td> <td>±---</td> <td>±---</td> </tr> <tr> <td>1 PLACE</td> <td>±---</td> <td>±---</td> </tr> <tr> <td colspan="3">ANGULAR ±----</td> </tr> </tbody> </table>		mm	INCH	4 PLACES	±---	±---	3 PLACES	±---	±---	2 PLACES	±---	±---	1 PLACE	±---	±---	ANGULAR ±----			DIMENSION STYLE MM ONLY	SCALE 1.5:1	DESIGN UNITS METRIC	THIRD ANGLE PROJECTION
		mm	INCH																					
	4 PLACES	±---	±---																					
	3 PLACES	±---	±---																					
2 PLACES	±---	±---																						
1 PLACE	±---	±---																						
ANGULAR ±----																								
DRAWN BY: SRAJENDRANAT DATE: 2008/05/09 CHECKED BY: TSK IVER DATE: 2008/05/09 APPROVED BY: VKOSHY DATE: 2010/03/18	MATERIAL NO. SD-34566-001	TITLE MX123 73/80 CKT HRNS CONN ASSY	SHEET NO. 2 OF 36																					
DRAFT WHERE APPLICABLE MUST REMAIN WITHIN DIMENSIONS	SEE BOM TABLE	MOLEX INCORPORATED	DOCUMENT NO.																					
THIS DRAWING CONTAINS INFORMATION THAT IS PROPRIETARY TO MOLEX INCORPORATED AND SHOULD NOT BE USED WITHOUT WRITTEN PERMISSION	SIZE D	MOLEX INCORPORATED	MOLEX INCORPORATED																					

19 18 17 16 15 14 13 12 11 10 9 8 7 6 5 4 3 2 1

20 19 18 17 16 15 14 13 12 11 10 9 8 7 6 5 4 3 2 1

WIRE DRESS OPTION 9
HOUSING ONLY, SHOWN FOR CLARITY

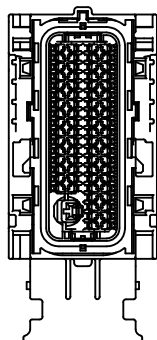

73 CT
KEY OPTION A

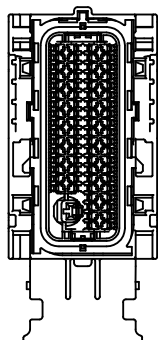

73 CT
KEY OPTION B

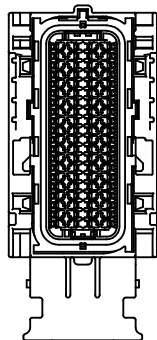

80 CT
KEY OPTION G

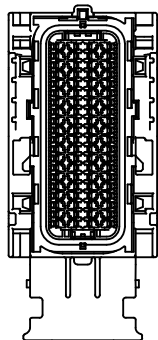

80 CT
KEY OPTION H

ENTER DESCRIPTION REC NO: UAU2010-1551 DRAWN BY: 2010/03/15 CHKD BY: FFJHS 2008/05/09 APPR: VKOSHY 2010/03/18	QUALITY SYMBOLS ▽=0 ▽=0	GENERAL TOLERANCES (UNLESS SPECIFIED)		DIMENSION STYLE MM ONLY	SCALE 1.5:1	DESIGN UNITS METRIC	THIRD ANGLE PROJECTION
		4 PLACES #---# 3 PLACES #---# 2 PLACES #---# 1 PLACE #---#	mm INCH	DRAWN BY: SRAJENDRANAT DATE: 2008/05/09	TITLE MX123 73/80 CT HRNS CONN ASSY		
		ANGULAR ±---°		CHECKED BY: TSK IVER DATE: 2008/05/09	APPROVED BY: VKOSHY DATE: 2010/03/18		
		DRAFT WHERE APPLICABLE MUST REMAIN WITHIN DIMENSIONS	SEE BOM TABLE	MATERIAL NO.		DOCUMENT NO.	SHEET NO.
T40				MOLEX INCORPORATED		SD-34566-001	3 OF 36
THIS DRAWING CONTAINS INFORMATION THAT IS PROPRIETARY TO MOLEX INCORPORATED AND SHOULD NOT BE USED WITHOUT WRITTEN PERMISSION							

19 18 17 16 15 14 13 12 11 10 9 8 7 6 5 4 3 2 1

WIRE DRESS OPTION 0

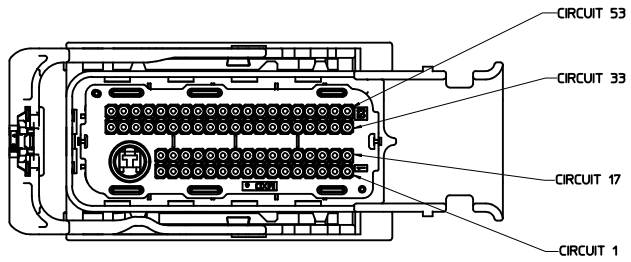

73 CKT

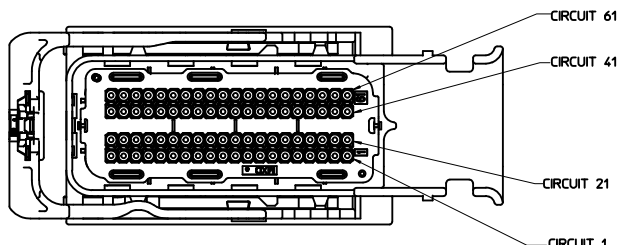

80 CKT

WIRE DRESS OPTION 9

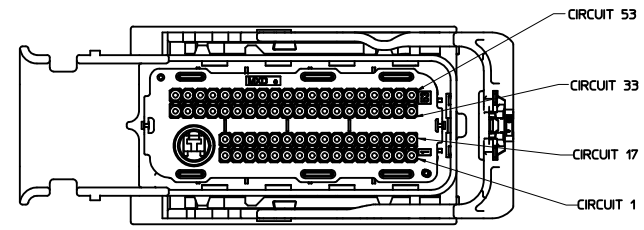

73 CKT

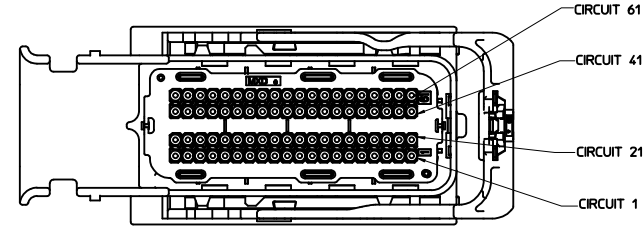

80 CKT

ENTER DESCRIPTION ECN NO: UAU2010-1551 DRAWN BY: DRWNAH01 CHECKED BY: CHKDGRFFHIS APPROVED BY: APPR.VKOSHY	QUALITY SYMBOLS ▽=0 ▽=0	GENERAL TOLERANCES (UNLESS SPECIFIED) mm INCH 4 PLACES ±--- ±--- 3 PLACES ±--- ±--- 2 PLACES ±--- ±--- 1 PLACE ±--- ±--- ANGULAR ±---°	DIMENSION STYLE MM ONLY	SCALE 2:1	DESIGN UNITS METRIC	THIRD ANGLE PROJECTION	
	DRAWN BY: SRAJENDRANAT CHECKED BY: TSKIVER APPROVED BY: VKOSHY	DATE: 2008/05/09 DATE: 2008/05/09 DATE: 2010/03/18	MATERIAL NO. SEE BOM TABLE	TITLE MX123 73/80 CKT HRNS CONN ASSY	DOCUMENT NO. SD-34566-001	SHEET NO. 4 OF 36	MOLEX INCORPORATED
	T40	DRAFT WHERE APPLICABLE MUST REMAIN WITHIN DIMENSIONS	SIZE D	THIS DRAWING CONTAINS INFORMATION THAT IS PROPRIETARY TO MOLEX INCORPORATED AND SHOULD NOT BE USED WITHOUT WRITTEN PERMISSION			

20 19 18 17 16 15 14 13 12 11 10 9 8 7 6 5 4 3 2 1

STATUS	GM PART #	MATERIAL #	PART/MATERIAL REVISION	WIRE DRESS OPTION	KEY OPTION ▽	COLOR (TPA) ▽	NUMBERS INDICATE CAVITIES OPEN FOR CIRCUITS ▽																																		
AVAILABLE	12582677	34566-0103	G	0	A	BLACK																																			
AVAILABLE	12582678	34566-0203	G	0	B	ST GRAY	72	71	70	69	68	67	66	65	64	63	62	61	60	59	58	57	56	55	54	53															
AVAILABLE	12615654	34566-0303	G	0	C	BLUE	52	51	50	49	48	47	46	45	44	43	42	41	40	39	38	37	36	35	34	33															
ACTIVE	TBD	34566-0403	G	0	D	BROWN	73							32	31	30	29	28	27	26	25	24	23	22	21	20	19	18	17												
ACTIVE	TBD	34566-0503	G	0	E	GREEN								16	15	14	13	12	11	10	9	8	7	6	5	4	3	2	1												
ACTIVE	TBD	34566-0603	G	0	F	NATURAL																																			
AVAILABLE	12588057	34566-0703	G	0	G	BLUE																																			
AVAILABLE	12588058	34566-0803	G	0	H	ST GRAY	80	79	78	77	76	75	74	73	72	71	70	69	68	67	66	65	64	63	62	61															
ACTIVE	TBD	34566-0903	G	0	J	BLACK	60	59	58	57	56	55	54	53	52	51	50	49	48	47	46	45	44	43	42	41															
ACTIVE	TBD	34566-1003	G	0	K	BROWN	40	39	38	37	36	35	34	33	32	31	30	29	28	27	26	25	24	23	22	21	20	19	18	17											
ACTIVE	TBD	34566-1103	G	0	L	GREEN																																			
ACTIVE	TBD	34566-1203	G	0	M	NATURAL																																			
AVAILABLE	12603596	34566-1303	G	9	A	BLACK																																			
AVAILABLE	12603597	34566-1403	G	9	B	ST GRAY	72	71	70	69	68	67	66	65	64	63	62	61	60	59	58	57	56	55	54	53															
AVAILABLE	12615655	34566-1503	G	9	C	BLUE	52	51	50	49	48	47	46	45	44	43	42	41	40	39	38	37	36	35	34	33															
ACTIVE	TBD	34566-1603	G	9	D	BROWN	73							32	31	30	29	28	27	26	25	24	23	22	21	20	19	18	17												
ACTIVE	TBD	34566-1703	G	9	E	GREEN								16	15	14	13	12	11	10	9	8	7	6	5	4	3	2	1												
ACTIVE	TBD	34566-1803	G	9	F	NATURAL																																			
AVAILABLE	12603598	34566-1903	G	9	G	BLUE																																			
AVAILABLE	12603599	34566-2003	G	9	H	ST GRAY	80	79	78	77	76	75	74	73	72	71	70	69	68	67	66	65	64	63	62	61															
ACTIVE	TBD	34566-2103	G	9	J	BLACK	60	59	58	57	56	55	54	53	52	51	50	49	48	47	46	45	44	43	42	41															
ACTIVE	TBD	34566-2203	G	9	K	BROWN	40	39	38	37	36	35	34	33	32	31	30	29	28	27	26	25	24	23	22	21	20	19	18	17											
ACTIVE	TBD	34566-2303	G	9	L	GREEN																																			
ACTIVE	TBD	34566-2403	G	9	M	NATURAL																																			
N/A	N/A	N/A	N/A	N/A	N/A	N/A	73																																		
AVAILABLE	NOT APPLICABLE	34566-2503	G	0	A	BLACK	72	71	70	69	68	67	66	65	64	63	62	61	60	59	58	57	56	55	54	53															
							50	48	46	44	43	42	41	40	39	38	37	36	35	34	33																				
							73							32	30	29	27	23	20	17																					
														14	13	12	11	9	8	5	4	3	2	1																	
AVAILABLE	NOT APPLICABLE	34566-2603	G	0	B	ST GRAY								67	66	65	64	63	62	61	60	59	57	55	53																
														49	48	47	44	43	42	41	40	39	37	35	33																
														73							29	28	23	21	7																
AVAILABLE	NOT APPLICABLE	34566-2703	G	0	B	ST GRAY								65	64	63	62	61	60	59	57	55	53																		
														49	48	47	44	43	42	41	40	39	37	35	33																
														73							29	28	23	21	7																

SEE NEXT PAGE FOR ADDITIONAL NUMBERS

ENTER DESCRIPTION EC NO: UAU2010-1551 DRAWN BY: DRWNAH01 CHECKED BY: CHKDORFF APPROVED BY: APPRVKOSHY DATE: 2010/03/15 DATE: 2008/05/09 DATE: 2010/03/18 REV: F40	QUALITY SYMBOLS ▽=0 ▽=0	GENERAL TOLERANCES (UNLESS SPECIFIED) <table border="1"> <tr> <th></th> <th>mm</th> <th>INCH</th> </tr> <tr> <td>4 PLACES</td> <td>±---</td> <td>±---</td> </tr> <tr> <td>3 PLACES</td> <td>±---</td> <td>±---</td> </tr> <tr> <td>2 PLACES</td> <td>±---</td> <td>±---</td> </tr> <tr> <td>1 PLACE</td> <td>±---</td> <td>±---</td> </tr> </table> ANGULAR ±---°		mm	INCH	4 PLACES	±---	±---	3 PLACES	±---	±---	2 PLACES	±---	±---	1 PLACE	±---	±---	DIMENSION STYLE MM ONLY	SCALE 1:1	DESIGN UNITS METRIC	THIRD ANGLE PROJECTION
		mm	INCH																		
	4 PLACES	±---	±---																		
	3 PLACES	±---	±---																		
2 PLACES	±---	±---																			
1 PLACE	±---	±---																			
			DRAWN BY SRAJENDRANAT	DATE 2008/05/09	TITLE MX123 73/80 CKT HRNS CONN ASSY																
			CHECKED BY TSKIVER	DATE 2008/05/09	MOLEX INCORPORATED																
			APPROVED BY VKOSHY	DATE 2010/03/18	MATERIAL NO. SD-34566-001	SHEET NO. 5 OF 36															

SEE BOM TABLE
 THIS DRAWING CONTAINS INFORMATION THAT IS PROPRIETARY TO MOLEX INCORPORATED AND SHOULD NOT BE USED WITHOUT WRITTEN PERMISSION

19 18 17 16 15 14 13 12 11 10 9 8 7 6 5 4 3 2 1

STATUS	GM PART #	MATERIAL #	PART/MATERIAL REVISION	WIRE DRESS OPTION	KEY OPTION	COLOR (TPA)	NUMBERS INDICATE CAVITIES OPEN FOR CIRCUITS																																																																																											
AVAILABLE	NOT APPLICABLE	34566-2803	G	0	H	ST GRAY	[Empty grid]																																																																																											
AVAILABLE	NOT APPLICABLE	34566-2903	G	0	A	BLACK	<table border="1"> <tr><td>72</td><td>71</td><td>70</td><td>69</td><td>68</td><td>67</td><td>66</td><td>64</td><td>63</td><td>62</td><td>61</td><td>59</td><td></td><td></td><td></td><td></td><td>55</td><td>54</td><td>53</td></tr> <tr><td>52</td><td>51</td><td>49</td><td>48</td><td>47</td><td>46</td><td></td><td>44</td><td>43</td><td>42</td><td>41</td><td>39</td><td></td><td></td><td></td><td></td><td>35</td><td>34</td><td>33</td></tr> <tr><td></td><td></td><td>73</td><td>32</td><td>31</td><td>29</td><td></td><td>27</td><td></td><td>25</td><td></td><td>23</td><td></td><td></td><td></td><td></td><td>19</td><td>18</td><td>17</td></tr> <tr><td></td><td></td><td></td><td>16</td><td></td><td>13</td><td>12</td><td>11</td><td></td><td>9</td><td>8</td><td>7</td><td>6</td><td>5</td><td>4</td><td>3</td><td>2</td><td>1</td><td></td></tr> </table>																72	71	70	69	68	67	66	64	63	62	61	59					55	54	53	52	51	49	48	47	46		44	43	42	41	39					35	34	33			73	32	31	29		27		25		23					19	18	17				16		13	12	11		9	8	7	6	5	4	3	2	1	
72	71	70	69	68	67	66	64	63	62	61	59					55	54	53																																																																																
52	51	49	48	47	46		44	43	42	41	39					35	34	33																																																																																
		73	32	31	29		27		25		23					19	18	17																																																																																
			16		13	12	11		9	8	7	6	5	4	3	2	1																																																																																	
AVAILABLE	NOT APPLICABLE	34566-3003	G	0	A	BLACK	<table border="1"> <tr><td>72</td><td>71</td><td>70</td><td>69</td><td>68</td><td>67</td><td>66</td><td>64</td><td>63</td><td>62</td><td>61</td><td>59</td><td>58</td><td>57</td><td>56</td><td>55</td><td>54</td><td>53</td></tr> <tr><td>52</td><td>51</td><td>50</td><td>49</td><td>48</td><td>47</td><td>46</td><td>44</td><td>43</td><td>42</td><td>41</td><td>40</td><td>39</td><td>38</td><td>37</td><td>36</td><td>35</td><td>34</td><td>33</td></tr> <tr><td></td><td></td><td>73</td><td>32</td><td>31</td><td>30</td><td>29</td><td>28</td><td>27</td><td>25</td><td>24</td><td>23</td><td>22</td><td>21</td><td>20</td><td>19</td><td>18</td><td>17</td></tr> <tr><td></td><td></td><td></td><td>16</td><td>15</td><td>14</td><td>13</td><td>12</td><td>11</td><td>9</td><td>8</td><td>7</td><td>6</td><td>5</td><td>4</td><td>3</td><td>2</td><td>1</td><td></td></tr> </table>																72	71	70	69	68	67	66	64	63	62	61	59	58	57	56	55	54	53	52	51	50	49	48	47	46	44	43	42	41	40	39	38	37	36	35	34	33			73	32	31	30	29	28	27	25	24	23	22	21	20	19	18	17				16	15	14	13	12	11	9	8	7	6	5	4	3	2	1			
72	71	70	69	68	67	66	64	63	62	61	59	58	57	56	55	54	53																																																																																	
52	51	50	49	48	47	46	44	43	42	41	40	39	38	37	36	35	34	33																																																																																
		73	32	31	30	29	28	27	25	24	23	22	21	20	19	18	17																																																																																	
			16	15	14	13	12	11	9	8	7	6	5	4	3	2	1																																																																																	
AVAILABLE	NOT APPLICABLE	34566-3103	G	0	B	ST GRAY	<table border="1"> <tr><td></td><td></td><td></td><td></td><td></td><td></td><td></td><td>65</td><td></td><td>62</td><td></td><td>59</td><td>57</td><td>55</td><td>53</td><td></td><td></td><td></td><td></td></tr> <tr><td></td><td></td><td>49</td><td>48</td><td></td><td>46</td><td></td><td></td><td></td><td>42</td><td></td><td>39</td><td>37</td><td>35</td><td>33</td><td></td><td></td><td></td><td></td></tr> <tr><td></td><td></td><td></td><td></td><td></td><td></td><td>29</td><td></td><td></td><td>26</td><td></td><td>23</td><td>21</td><td></td><td>18</td><td></td><td></td><td></td><td></td></tr> <tr><td></td><td></td><td>73</td><td></td><td></td><td>15</td><td></td><td></td><td></td><td></td><td>9</td><td>8</td><td>7</td><td></td><td>4</td><td>3</td><td></td><td></td><td></td></tr> </table>																							65		62		59	57	55	53							49	48		46				42		39	37	35	33											29			26		23	21		18							73			15					9	8	7		4	3			
							65		62		59	57	55	53																																																																																				
		49	48		46				42		39	37	35	33																																																																																				
						29			26		23	21		18																																																																																				
		73			15					9	8	7		4	3																																																																																			
AVAILABLE	NOT APPLICABLE	34566-3203	G	0	B	ST GRAY	<table border="1"> <tr><td></td><td></td><td></td><td></td><td></td><td>67</td><td></td><td></td><td></td><td></td><td></td><td>60</td><td>59</td><td>58</td><td>57</td><td>56</td><td>55</td><td>53</td></tr> <tr><td></td><td></td><td>50</td><td>49</td><td>48</td><td></td><td>46</td><td></td><td></td><td></td><td></td><td>39</td><td>38</td><td>37</td><td>36</td><td>35</td><td>34</td><td>33</td></tr> <tr><td></td><td></td><td></td><td></td><td></td><td></td><td></td><td></td><td></td><td>29</td><td></td><td>23</td><td>22</td><td>21</td><td></td><td>18</td><td></td><td></td></tr> <tr><td></td><td></td><td>73</td><td></td><td></td><td>16</td><td>15</td><td>14</td><td></td><td></td><td></td><td>7</td><td>6</td><td>5</td><td>4</td><td>3</td><td></td><td></td></tr> </table>																					67						60	59	58	57	56	55	53			50	49	48		46					39	38	37	36	35	34	33										29		23	22	21		18					73			16	15	14				7	6	5	4	3						
					67						60	59	58	57	56	55	53																																																																																	
		50	49	48		46					39	38	37	36	35	34	33																																																																																	
									29		23	22	21		18																																																																																			
		73			16	15	14				7	6	5	4	3																																																																																			
AVAILABLE	NOT APPLICABLE	34566-3303	G	0	B	ST GRAY	<table border="1"> <tr><td></td><td></td><td></td><td></td><td></td><td></td><td></td><td></td><td></td><td></td><td></td><td>59</td><td>58</td><td>57</td><td>56</td><td>55</td><td>53</td></tr> <tr><td></td><td></td><td>50</td><td>49</td><td>48</td><td></td><td>46</td><td></td><td></td><td></td><td></td><td>39</td><td>38</td><td>37</td><td>36</td><td>35</td><td>34</td><td>33</td></tr> <tr><td></td><td></td><td></td><td></td><td></td><td></td><td></td><td></td><td></td><td>29</td><td></td><td>23</td><td>22</td><td>21</td><td></td><td>18</td><td></td><td></td></tr> <tr><td></td><td></td><td>73</td><td></td><td></td><td>16</td><td>15</td><td>14</td><td></td><td></td><td></td><td>7</td><td>6</td><td>5</td><td>4</td><td>3</td><td></td><td></td></tr> </table>																											59	58	57	56	55	53			50	49	48		46					39	38	37	36	35	34	33										29		23	22	21		18					73			16	15	14				7	6	5	4	3							
											59	58	57	56	55	53																																																																																		
		50	49	48		46					39	38	37	36	35	34	33																																																																																	
									29		23	22	21		18																																																																																			
		73			16	15	14				7	6	5	4	3																																																																																			
AVAILABLE	NOT APPLICABLE	34566-3403	SEE 34566-3003																																																																																															
AVAILABLE	NOT APPLICABLE	34566-3503	G	0	A	BLACK	<table border="1"> <tr><td>72</td><td>71</td><td>69</td><td>68</td><td>67</td><td>66</td><td>64</td><td>63</td><td>62</td><td>60</td><td>59</td><td></td><td></td><td></td><td></td><td></td><td></td><td></td><td></td></tr> <tr><td>52</td><td></td><td>49</td><td>48</td><td></td><td>46</td><td>44</td><td>43</td><td>42</td><td>40</td><td>39</td><td></td><td></td><td></td><td></td><td></td><td>35</td><td>34</td><td>33</td></tr> <tr><td></td><td></td><td></td><td>73</td><td>32</td><td></td><td>29</td><td></td><td>27</td><td></td><td>24</td><td>23</td><td></td><td></td><td></td><td></td><td></td><td></td><td></td></tr> <tr><td></td><td></td><td></td><td></td><td></td><td></td><td>14</td><td>13</td><td>12</td><td>11</td><td>9</td><td>8</td><td>7</td><td>6</td><td>5</td><td>4</td><td>3</td><td>2</td><td>1</td></tr> </table>																72	71	69	68	67	66	64	63	62	60	59									52		49	48		46	44	43	42	40	39						35	34	33				73	32		29		27		24	23														14	13	12	11	9	8	7	6	5	4	3	2	1
72	71	69	68	67	66	64	63	62	60	59																																																																																								
52		49	48		46	44	43	42	40	39						35	34	33																																																																																
			73	32		29		27		24	23																																																																																							
						14	13	12	11	9	8	7	6	5	4	3	2	1																																																																																

SEE NEXT PAGE FOR ADDITIONAL NUMBERS

ENTER DESCRIPTION EC NO: UAU2010-1551 DRAWN BY: 2010/03/15 CHKDGR: FFH 2008/05/09 APPR: VKOSHY 2010/03/18 F40	QUALITY SYMBOLS ▽=0 ▽=0	GENERAL TOLERANCES (UNLESS SPECIFIED) mm INCH 4 PLACES ±---+--- 3 PLACES ±---+--- 2 PLACES ±---+--- 1 PLACE ±---+--- ANGULAR ±---°	DIMENSION STYLE MM ONLY	SCALE 1:1	DESIGN UNITS METRIC	THIRD ANGLE PROJECTION	
	DRAWN BY: SRAJENDRANAT 2008/05/09 CHECKED BY: TSKIVER 2008/05/09 APPROVED BY: VKOSHY 2010/03/18		TITLE MX123 73/80 CKT HRNS CONN ASSY				
	DRAFT WHERE APPLICABLE MUST REMAIN WITHIN DIMENSIONS		MATERIAL NO. SEE BOM TABLE		DOCUMENT NO. SD-34566-001		SHEET NO. 6 OF 36
	THIS DRAWING CONTAINS INFORMATION THAT IS PROPRIETARY TO MOLEX INCORPORATED AND SHOULD NOT BE USED WITHOUT WRITTEN PERMISSION						

20 19 18 17 16 15 14 13 12 11 10 9 8 7 6 5 4 3 2 1

STATUS	GM PART #	MATERIAL #	PART/MATERIAL REVISION	WIRE DRESS OPTION	KEY OPTION	COLOR (TPA)	NUMBERS INDICATE CAVITIES OPEN FOR CIRCUITS																																																																															
AVAILABLE	NOT APPLICABLE	34566-7603	G	0	B	ST GRY	<table border="1"> <tr><td></td><td></td><td>69</td><td>68</td><td>66</td><td></td><td></td><td></td><td></td><td></td><td>59</td><td>57</td><td>55</td><td>53</td></tr> <tr><td></td><td></td><td>49</td><td>48</td><td>46</td><td></td><td>44</td><td></td><td></td><td></td><td>39</td><td>37</td><td>35</td><td>33</td></tr> <tr><td>73</td><td></td><td></td><td></td><td></td><td>29</td><td>28</td><td></td><td></td><td></td><td>23</td><td>21</td><td></td><td>18</td><td>17</td></tr> <tr><td></td><td></td><td></td><td></td><td></td><td></td><td>12</td><td>11</td><td>10</td><td></td><td>7</td><td></td><td></td><td></td><td></td></tr> </table>			69	68	66						59	57	55	53			49	48	46		44				39	37	35	33	73					29	28				23	21		18	17							12	11	10		7																									
		69	68	66						59	57	55	53																																																																									
		49	48	46		44				39	37	35	33																																																																									
73					29	28				23	21		18	17																																																																								
						12	11	10		7																																																																												
AVAILABLE	NOT APPLICABLE	34566-7703	G	0	A	BLACK	<table border="1"> <tr><td>72</td><td>71</td><td>70</td><td>69</td><td>68</td><td>67</td><td>66</td><td></td><td>64</td><td>63</td><td>62</td><td></td><td>60</td><td>59</td><td></td><td></td><td>55</td><td>54</td><td>53</td></tr> <tr><td>52</td><td></td><td>49</td><td>48</td><td></td><td></td><td></td><td></td><td>44</td><td>43</td><td>42</td><td></td><td>40</td><td>39</td><td></td><td></td><td>35</td><td>34</td><td>33</td></tr> <tr><td></td><td>73</td><td></td><td></td><td>32</td><td></td><td></td><td>29</td><td>27</td><td></td><td></td><td></td><td>24</td><td>23</td><td></td><td></td><td>19</td><td>18</td><td>17</td></tr> <tr><td></td><td></td><td></td><td></td><td>16</td><td></td><td></td><td>13</td><td>12</td><td>11</td><td></td><td>9</td><td>8</td><td>7</td><td>6</td><td>5</td><td>4</td><td>3</td><td>2</td><td>1</td></tr> </table>	72	71	70	69	68	67	66		64	63	62		60	59			55	54	53	52		49	48					44	43	42		40	39			35	34	33		73			32			29	27				24	23			19	18	17					16			13	12	11		9	8	7	6	5	4	3	2	1		
72	71	70	69	68	67	66		64	63	62		60	59			55	54	53																																																																				
52		49	48					44	43	42		40	39			35	34	33																																																																				
	73			32			29	27				24	23			19	18	17																																																																				
				16			13	12	11		9	8	7	6	5	4	3	2	1																																																																			
AVAILABLE	NOT APPLICABLE	34566-7803	G	0	A	BLACK	<table border="1"> <tr><td>72</td><td>71</td><td>70</td><td></td><td>68</td><td>66</td><td></td><td>64</td><td>63</td><td>62</td><td>61</td><td>60</td><td>59</td><td></td><td></td><td></td><td>55</td><td>54</td><td>53</td></tr> <tr><td>52</td><td></td><td>49</td><td>48</td><td></td><td>46</td><td></td><td>44</td><td>43</td><td>42</td><td></td><td>40</td><td>39</td><td></td><td></td><td></td><td>35</td><td>34</td><td>33</td></tr> <tr><td></td><td>73</td><td></td><td></td><td>32</td><td></td><td></td><td>29</td><td>28</td><td>27</td><td></td><td></td><td>24</td><td>23</td><td></td><td></td><td>19</td><td>18</td><td>17</td></tr> <tr><td></td><td></td><td></td><td></td><td>16</td><td></td><td>14</td><td>13</td><td>12</td><td>11</td><td></td><td>9</td><td>8</td><td>7</td><td>6</td><td></td><td>3</td><td>2</td><td>1</td></tr> </table>	72	71	70		68	66		64	63	62	61	60	59				55	54	53	52		49	48		46		44	43	42		40	39				35	34	33		73			32			29	28	27			24	23			19	18	17					16		14	13	12	11		9	8	7	6		3	2	1			
72	71	70		68	66		64	63	62	61	60	59				55	54	53																																																																				
52		49	48		46		44	43	42		40	39				35	34	33																																																																				
	73			32			29	28	27			24	23			19	18	17																																																																				
				16		14	13	12	11		9	8	7	6		3	2	1																																																																				
AVAILABLE	NOT APPLICABLE	34566-7903	G	0	B	ST GRY	<table border="1"> <tr><td></td><td></td><td></td><td></td><td></td><td></td><td></td><td></td><td>64</td><td></td><td>61</td><td>59</td><td>57</td><td>55</td><td>53</td></tr> <tr><td></td><td></td><td></td><td></td><td></td><td></td><td></td><td></td><td></td><td></td><td>42</td><td></td><td>39</td><td></td><td>35</td><td>33</td></tr> <tr><td>73</td><td></td><td></td><td></td><td></td><td></td><td></td><td></td><td></td><td></td><td></td><td></td><td>23</td><td></td><td>20</td><td>19</td><td>18</td><td>17</td></tr> <tr><td></td><td></td><td></td><td></td><td></td><td></td><td></td><td></td><td></td><td></td><td></td><td></td><td></td><td></td><td>4</td><td>3</td><td>2</td><td>1</td></tr> </table>									64		61	59	57	55	53											42		39		35	33	73												23		20	19	18	17															4	3	2	1												
								64		61	59	57	55	53																																																																								
										42		39		35	33																																																																							
73												23		20	19	18	17																																																																					
														4	3	2	1																																																																					
AVAILABLE	NOT APPLICABLE	34566-8003	G	0	A	BLACK	<table border="1"> <tr><td></td><td></td><td>69</td><td>68</td><td></td><td></td><td>65</td><td>64</td><td>63</td><td></td><td>61</td><td>60</td><td>59</td><td>58</td><td>56</td><td></td><td></td><td></td><td></td></tr> <tr><td>52</td><td>50</td><td>49</td><td>48</td><td>47</td><td></td><td></td><td></td><td></td><td></td><td>41</td><td></td><td></td><td>38</td><td>37</td><td>36</td><td></td><td>34</td><td>33</td></tr> <tr><td></td><td>73</td><td></td><td></td><td></td><td>32</td><td>31</td><td>30</td><td>29</td><td>28</td><td>27</td><td></td><td>24</td><td>23</td><td></td><td></td><td>20</td><td>19</td><td>18</td><td>17</td></tr> <tr><td></td><td></td><td></td><td></td><td></td><td>16</td><td></td><td></td><td>13</td><td>12</td><td>11</td><td>10</td><td>9</td><td></td><td></td><td></td><td></td><td></td><td></td><td>1</td></tr> </table>			69	68			65	64	63		61	60	59	58	56					52	50	49	48	47						41			38	37	36		34	33		73				32	31	30	29	28	27		24	23			20	19	18	17						16			13	12	11	10	9							1	
		69	68			65	64	63		61	60	59	58	56																																																																								
52	50	49	48	47						41			38	37	36		34	33																																																																				
	73				32	31	30	29	28	27		24	23			20	19	18	17																																																																			
					16			13	12	11	10	9							1																																																																			
AVAILABLE	NOT APPLICABLE	34566-8103	G	0	H	ST GRY	<table border="1"> <tr><td></td><td>78</td><td></td><td></td><td></td><td></td><td></td><td>72</td><td>71</td><td>70</td><td>69</td><td>68</td><td></td><td>66</td><td>65</td><td>64</td><td>63</td><td>61</td></tr> <tr><td>60</td><td>59</td><td>58</td><td>57</td><td>56</td><td></td><td></td><td>53</td><td>52</td><td>50</td><td></td><td></td><td></td><td></td><td></td><td>44</td><td>43</td><td>41</td></tr> <tr><td>40</td><td></td><td></td><td>37</td><td></td><td>35</td><td>34</td><td>33</td><td>32</td><td></td><td>30</td><td>29</td><td></td><td>27</td><td>26</td><td>24</td><td></td><td>22</td><td>21</td></tr> <tr><td>20</td><td>19</td><td>18</td><td>17</td><td>16</td><td></td><td></td><td>13</td><td>12</td><td></td><td></td><td></td><td>8</td><td>6</td><td>5</td><td></td><td>3</td><td>2</td><td></td></tr> </table>		78						72	71	70	69	68		66	65	64	63	61	60	59	58	57	56			53	52	50						44	43	41	40			37		35	34	33	32		30	29		27	26	24		22	21	20	19	18	17	16			13	12				8	6	5		3	2						
	78						72	71	70	69	68		66	65	64	63	61																																																																					
60	59	58	57	56			53	52	50						44	43	41																																																																					
40			37		35	34	33	32		30	29		27	26	24		22	21																																																																				
20	19	18	17	16			13	12				8	6	5		3	2																																																																					
AVAILABLE	NOT APPLICABLE	34566-8203	G	0	A	BLACK	<table border="1"> <tr><td></td><td>70</td><td></td><td>67</td><td>66</td><td></td><td></td><td></td><td></td><td></td><td></td><td></td><td>58</td><td>56</td><td>55</td><td>54</td><td></td><td></td><td></td></tr> <tr><td></td><td></td><td></td><td>47</td><td></td><td></td><td>44</td><td>43</td><td>42</td><td>41</td><td></td><td>39</td><td></td><td>37</td><td>36</td><td></td><td>34</td><td></td><td></td></tr> <tr><td>73</td><td></td><td></td><td></td><td>31</td><td>30</td><td></td><td></td><td>27</td><td>25</td><td>24</td><td></td><td></td><td>21</td><td>20</td><td>19</td><td>18</td><td></td><td></td></tr> <tr><td></td><td></td><td></td><td></td><td></td><td></td><td>13</td><td></td><td></td><td></td><td></td><td></td><td></td><td>6</td><td>5</td><td>4</td><td>3</td><td>2</td><td>1</td></tr> </table>		70		67	66								58	56	55	54							47			44	43	42	41		39		37	36		34			73				31	30			27	25	24			21	20	19	18									13							6	5	4	3	2	1			
	70		67	66								58	56	55	54																																																																							
			47			44	43	42	41		39		37	36		34																																																																						
73				31	30			27	25	24			21	20	19	18																																																																						
						13							6	5	4	3	2	1																																																																				
AVAILABLE	NOT APPLICABLE	34566-8303	G	0	A	BLACK	<table border="1"> <tr><td>72</td><td>71</td><td>69</td><td>68</td><td>67</td><td>66</td><td></td><td>64</td><td>63</td><td>62</td><td></td><td>59</td><td>58</td><td>57</td><td>56</td><td></td><td>54</td><td>53</td></tr> <tr><td>52</td><td>51</td><td>50</td><td>49</td><td>48</td><td>47</td><td>46</td><td></td><td>44</td><td>43</td><td>42</td><td></td><td>39</td><td>38</td><td>37</td><td>36</td><td>35</td><td>34</td><td>33</td></tr> <tr><td></td><td></td><td></td><td></td><td></td><td></td><td></td><td>32</td><td>31</td><td>30</td><td>29</td><td></td><td>27</td><td>24</td><td>23</td><td>22</td><td>21</td><td>20</td><td>19</td><td>17</td></tr> <tr><td></td><td></td><td></td><td></td><td></td><td></td><td></td><td>15</td><td>14</td><td>13</td><td>12</td><td>11</td><td></td><td>9</td><td>8</td><td>7</td><td>6</td><td>5</td><td>4</td><td>3</td><td>2</td><td>1</td></tr> </table>	72	71	69	68	67	66		64	63	62		59	58	57	56		54	53	52	51	50	49	48	47	46		44	43	42		39	38	37	36	35	34	33								32	31	30	29		27	24	23	22	21	20	19	17								15	14	13	12	11		9	8	7	6	5	4	3	2	1
72	71	69	68	67	66		64	63	62		59	58	57	56		54	53																																																																					
52	51	50	49	48	47	46		44	43	42		39	38	37	36	35	34	33																																																																				
							32	31	30	29		27	24	23	22	21	20	19	17																																																																			
							15	14	13	12	11		9	8	7	6	5	4	3	2	1																																																																	

SEE NEXT PAGE FOR ADDITIONAL NUMBERS

ENTER DESCRIPTION EC NO: UAU2010-1551 DRAWN BY: DRWNAH01 CHECKED BY: CHKDRFF1HS APPROVED BY: APPR.VKOSHY DATE: 2010/03/15 DATE: 2008/05/09 DATE: 2010/03/18 F40	QUALITY SYMBOLS ▽=0 ▽=0	GENERAL TOLERANCES (UNLESS SPECIFIED) <table border="1"> <tr><th></th><th>mm</th><th>INCH</th></tr> <tr><td>4 PLACES ±</td><td>---</td><td>---</td></tr> <tr><td>3 PLACES ±</td><td>---</td><td>---</td></tr> <tr><td>2 PLACES ±</td><td>---</td><td>---</td></tr> <tr><td>1 PLACE ±</td><td>---</td><td>---</td></tr> </table>		mm	INCH	4 PLACES ±	---	---	3 PLACES ±	---	---	2 PLACES ±	---	---	1 PLACE ±	---	---	DIMENSION STYLE MM ONLY	SCALE 1:1	DESIGN UNITS METRIC	THIRD ANGLE PROJECTION
		mm	INCH																		
	4 PLACES ±	---	---																		
	3 PLACES ±	---	---																		
2 PLACES ±	---	---																			
1 PLACE ±	---	---																			
DRAFT WHERE APPLICABLE MUST REMAIN WITHIN DIMENSIONS	SEE BOM TABLE	MATERIAL NO. SD-34566-001	DOCUMENT NO. SD-34566-001	SHEET NO. 12 OF 36	TITLE MX123 73/80 CKT HRNS CONN ASSY																
MOLEX INCORPORATED		MOLEX INCORPORATED		MOLEX INCORPORATED																	
THIS DRAWING CONTAINS INFORMATION THAT IS PROPRIETARY TO MOLEX INCORPORATED AND SHOULD NOT BE USED WITHOUT WRITTEN PERMISSION																					

19 18 17 16 15 14 13 12 11 10 9 8 7 6 5 4 3 2 1

20 19 18 17 16 15 14 13 12 11 10 9 8 7 6 5 4 3 2 1

STATUS	GM PART #	MATERIAL #	PART/MATERIAL REVISION	WIRE DRESS OPTION	KEY OPTION	COLOR (TPA)	NUMBERS INDICATE CAVITIES OPEN FOR CIRCUITS																																																																																																																																																			
AVAILABLE	NOT APPLICABLE	34566-1013	G	0	A	BLACK	<table border="1"> <tr><td>71</td><td>69</td><td>68</td><td></td><td>65</td><td>64</td><td>63</td><td>61</td><td>59</td><td>58</td><td>57</td><td>56</td><td></td><td></td><td></td><td></td><td></td><td></td><td></td><td></td></tr> <tr><td>52</td><td>50</td><td>49</td><td>47</td><td></td><td></td><td></td><td>41</td><td></td><td></td><td></td><td></td><td></td><td></td><td></td><td></td><td></td><td></td><td></td><td></td></tr> <tr><td></td><td></td><td></td><td>32</td><td>31</td><td>30</td><td>29</td><td>28</td><td>27</td><td></td><td>24</td><td>23</td><td></td><td></td><td></td><td></td><td></td><td></td><td></td><td></td></tr> <tr><td></td><td></td><td></td><td>16</td><td></td><td></td><td>13</td><td>12</td><td>11</td><td>10</td><td>9</td><td></td><td></td><td></td><td></td><td></td><td></td><td></td><td>3</td><td>2</td><td>1</td></tr> </table>																71	69	68		65	64	63	61	59	58	57	56									52	50	49	47				41																32	31	30	29	28	27		24	23												16			13	12	11	10	9								3	2	1																																																			
71	69	68		65	64	63	61	59	58	57	56																																																																																																																																															
52	50	49	47				41																																																																																																																																																			
			32	31	30	29	28	27		24	23																																																																																																																																															
			16			13	12	11	10	9								3	2	1																																																																																																																																						
AVAILABLE	NOT APPLICABLE	34566-1023	G	0	A	BLACK	<table border="1"> <tr><td></td><td>70</td><td></td><td>67</td><td>66</td><td>65</td><td></td><td></td><td></td><td></td><td></td><td></td><td></td><td></td><td></td><td></td><td></td><td>58</td><td>57</td><td>55</td><td>54</td></tr> <tr><td></td><td>50</td><td>49</td><td>47</td><td></td><td></td><td>44</td><td>43</td><td>42</td><td>41</td><td>39</td><td>37</td><td>35</td><td></td><td></td><td></td><td></td><td></td><td></td><td></td><td></td></tr> <tr><td></td><td></td><td></td><td>32</td><td>30</td><td></td><td></td><td>27</td><td>25</td><td>24</td><td></td><td></td><td></td><td></td><td></td><td></td><td></td><td>21</td><td>20</td><td>19</td><td>18</td><td>17</td></tr> <tr><td></td><td></td><td></td><td>16</td><td>15</td><td>13</td><td></td><td></td><td>10</td><td>9</td><td>8</td><td>6</td><td>5</td><td></td><td></td><td></td><td></td><td></td><td></td><td></td><td></td><td>3</td><td>2</td><td>1</td></tr> </table>																	70		67	66	65												58	57	55	54		50	49	47			44	43	42	41	39	37	35												32	30			27	25	24								21	20	19	18	17				16	15	13			10	9	8	6	5									3	2	1																																												
	70		67	66	65												58	57	55	54																																																																																																																																						
	50	49	47			44	43	42	41	39	37	35																																																																																																																																														
			32	30			27	25	24								21	20	19	18	17																																																																																																																																					
			16	15	13			10	9	8	6	5									3	2	1																																																																																																																																			
AVAILABLE	NOT APPLICABLE	34566-1033	G	0	A	BLACK	<table border="1"> <tr><td>72</td><td>70</td><td></td><td>67</td><td>66</td><td>65</td><td></td><td></td><td></td><td></td><td></td><td></td><td></td><td></td><td></td><td></td><td></td><td>58</td><td>57</td><td>55</td><td>54</td></tr> <tr><td></td><td>50</td><td>49</td><td>47</td><td></td><td></td><td>44</td><td>43</td><td>42</td><td>41</td><td>39</td><td>37</td><td>35</td><td></td><td></td><td></td><td></td><td></td><td></td><td></td><td></td><td></td><td></td><td></td></tr> <tr><td></td><td></td><td></td><td>32</td><td>30</td><td></td><td></td><td>27</td><td>26</td><td>25</td><td>24</td><td></td><td></td><td></td><td></td><td></td><td></td><td>21</td><td>20</td><td>19</td><td>18</td><td>17</td><td></td><td></td></tr> <tr><td></td><td></td><td></td><td>16</td><td>15</td><td>13</td><td></td><td></td><td>10</td><td>9</td><td>8</td><td>6</td><td>5</td><td></td><td></td><td></td><td></td><td></td><td></td><td></td><td></td><td></td><td></td><td></td><td>3</td><td>2</td><td>1</td></tr> </table>																72	70		67	66	65												58	57	55	54		50	49	47			44	43	42	41	39	37	35															32	30			27	26	25	24							21	20	19	18	17						16	15	13			10	9	8	6	5												3	2	1																																				
72	70		67	66	65												58	57	55	54																																																																																																																																						
	50	49	47			44	43	42	41	39	37	35																																																																																																																																														
			32	30			27	26	25	24							21	20	19	18	17																																																																																																																																					
			16	15	13			10	9	8	6	5												3	2	1																																																																																																																																
AVAILABLE	NOT APPLICABLE	34566-1043	G	0	B	ST GRAY	<table border="1"> <tr><td></td><td>71</td><td>70</td><td></td><td>68</td><td>66</td><td>65</td><td></td><td></td><td></td><td></td><td></td><td></td><td></td><td></td><td></td><td></td><td>59</td><td>58</td><td>57</td><td></td><td>54</td><td>53</td></tr> <tr><td></td><td>51</td><td>50</td><td>49</td><td>48</td><td>46</td><td>45</td><td>43</td><td>41</td><td>40</td><td>39</td><td>38</td><td>37</td><td>36</td><td>35</td><td>33</td><td></td><td></td><td></td><td></td><td></td><td></td><td></td><td></td><td></td><td></td><td></td></tr> <tr><td></td><td></td><td></td><td>32</td><td>31</td><td>30</td><td></td><td></td><td></td><td></td><td></td><td></td><td></td><td></td><td></td><td></td><td></td><td></td><td></td><td></td><td></td><td></td><td></td><td></td><td></td><td></td><td></td></tr> <tr><td></td><td></td><td></td><td>16</td><td></td><td></td><td>13</td><td>12</td><td>11</td><td>10</td><td>9</td><td>8</td><td>7</td><td>6</td><td>5</td><td>4</td><td></td><td></td><td></td><td></td><td></td><td></td><td></td><td></td><td></td><td></td><td></td></tr> </table>																	71	70		68	66	65											59	58	57		54	53		51	50	49	48	46	45	43	41	40	39	38	37	36	35	33															32	31	30																									16			13	12	11	10	9	8	7	6	5	4																																							
	71	70		68	66	65											59	58	57		54	53																																																																																																																																				
	51	50	49	48	46	45	43	41	40	39	38	37	36	35	33																																																																																																																																											
			32	31	30																																																																																																																																																					
			16			13	12	11	10	9	8	7	6	5	4																																																																																																																																											
AVAILABLE	NOT APPLICABLE	34566-1053	G	0	H	ST GRAY	<table border="1"> <tr><td></td><td>79</td><td>78</td><td>77</td><td>76</td><td>75</td><td>74</td><td>73</td><td>72</td><td>71</td><td>70</td><td>69</td><td>68</td><td></td><td></td><td></td><td></td><td>66</td><td>65</td><td>64</td><td>63</td><td>61</td></tr> <tr><td>60</td><td>59</td><td>58</td><td>57</td><td>56</td><td></td><td></td><td></td><td></td><td></td><td>53</td><td>52</td><td>50</td><td></td><td></td><td></td><td></td><td></td><td></td><td></td><td></td><td></td><td>44</td><td>43</td><td>41</td></tr> <tr><td>40</td><td>39</td><td>38</td><td>37</td><td></td><td>35</td><td>34</td><td>33</td><td>32</td><td></td><td>30</td><td>29</td><td></td><td></td><td></td><td></td><td></td><td>27</td><td>26</td><td></td><td></td><td></td><td></td><td></td><td></td><td></td><td>22</td><td>21</td></tr> <tr><td>20</td><td>19</td><td>18</td><td>17</td><td>16</td><td></td><td></td><td>14</td><td>13</td><td>12</td><td>11</td><td></td><td>9</td><td>8</td><td>7</td><td>6</td><td>5</td><td></td><td></td><td></td><td></td><td></td><td></td><td></td><td></td><td></td><td></td><td></td></tr> </table>																	79	78	77	76	75	74	73	72	71	70	69	68					66	65	64	63	61	60	59	58	57	56						53	52	50										44	43	41	40	39	38	37		35	34	33	32		30	29						27	26								22	21	20	19	18	17	16			14	13	12	11		9	8	7	6	5																																								
	79	78	77	76	75	74	73	72	71	70	69	68					66	65	64	63	61																																																																																																																																					
60	59	58	57	56						53	52	50										44	43	41																																																																																																																																		
40	39	38	37		35	34	33	32		30	29						27	26								22	21																																																																																																																															
20	19	18	17	16			14	13	12	11		9	8	7	6	5																																																																																																																																										
AVAILABLE	NOT APPLICABLE	34566-1063	G	0	B	ST GRAY	<table border="1"> <tr><td></td><td></td><td></td><td></td><td></td><td></td><td></td><td></td><td></td><td></td><td></td><td></td><td></td><td></td><td></td><td></td><td></td><td>60</td><td>59</td><td>57</td><td>56</td><td>55</td><td>53</td></tr> <tr><td></td><td></td><td></td><td>49</td><td>48</td><td>47</td><td></td><td></td><td></td><td></td><td></td><td></td><td></td><td></td><td></td><td></td><td></td><td></td><td>40</td><td>39</td><td>37</td><td>36</td><td>35</td><td>33</td></tr> <tr><td></td><td></td><td></td><td></td><td></td><td></td><td></td><td></td><td></td><td></td><td></td><td></td><td></td><td></td><td></td><td></td><td></td><td></td><td></td><td></td><td></td><td></td><td></td><td></td><td></td><td></td><td></td><td></td></tr> <tr><td></td><td></td><td></td><td></td><td></td><td></td><td></td><td></td><td></td><td></td><td></td><td></td><td></td><td></td><td></td><td></td><td></td><td></td><td>24</td><td>23</td><td>22</td><td>21</td><td></td><td></td><td></td><td></td><td></td><td></td></tr> <tr><td></td><td></td><td></td><td></td><td></td><td></td><td></td><td></td><td></td><td></td><td></td><td></td><td></td><td></td><td></td><td></td><td></td><td></td><td></td><td></td><td></td><td></td><td></td><td></td><td></td><td></td><td></td><td></td><td>2</td></tr> </table>																																	60	59	57	56	55	53				49	48	47													40	39	37	36	35	33																																															24	23	22	21																																			2
																	60	59	57	56	55	53																																																																																																																																				
			49	48	47													40	39	37	36	35	33																																																																																																																																			
																		24	23	22	21																																																																																																																																					
																												2																																																																																																																														
AVAILABLE	NOT APPLICABLE	34566-1073	G	0	A	BLACK	<table border="1"> <tr><td>72</td><td>71</td><td>70</td><td>69</td><td>68</td><td>67</td><td>66</td><td>65</td><td>64</td><td>63</td><td>61</td><td>59</td><td>58</td><td>57</td><td>56</td><td>54</td><td></td><td></td><td></td><td></td><td></td><td></td><td></td><td></td><td></td><td></td><td></td><td></td></tr> <tr><td></td><td>50</td><td>49</td><td>48</td><td>47</td><td></td><td></td><td></td><td></td><td></td><td>42</td><td>41</td><td></td><td></td><td></td><td></td><td></td><td></td><td></td><td></td><td></td><td></td><td></td><td></td><td></td><td></td><td></td><td></td><td></td></tr> <tr><td></td><td></td><td></td><td>32</td><td>31</td><td>30</td><td>29</td><td>28</td><td>27</td><td>26</td><td></td><td>24</td><td>23</td><td></td><td></td><td></td><td></td><td></td><td></td><td></td><td></td><td></td><td></td><td></td><td></td><td></td><td></td><td></td><td></td></tr> <tr><td></td><td></td><td></td><td>16</td><td></td><td></td><td>13</td><td>12</td><td>11</td><td>10</td><td>9</td><td></td><td></td><td></td><td></td><td></td><td></td><td></td><td></td><td></td><td></td><td></td><td></td><td></td><td></td><td></td><td></td><td></td><td></td></tr> </table>																72	71	70	69	68	67	66	65	64	63	61	59	58	57	56	54														50	49	48	47						42	41																					32	31	30	29	28	27	26		24	23																				16			13	12	11	10	9																																			
72	71	70	69	68	67	66	65	64	63	61	59	58	57	56	54																																																																																																																																											
	50	49	48	47						42	41																																																																																																																																															
			32	31	30	29	28	27	26		24	23																																																																																																																																														
			16			13	12	11	10	9																																																																																																																																																
AVAILABLE	NOT APPLICABLE	34566-1083	G	0	B	ST GRAY	<table border="1"> <tr><td></td><td></td><td></td><td></td><td>68</td><td>67</td><td>66</td><td>65</td><td>64</td><td></td><td></td><td></td><td></td><td></td><td></td><td></td><td></td><td>59</td><td>58</td><td>57</td><td>55</td><td>54</td><td>53</td></tr> <tr><td></td><td>51</td><td>50</td><td>49</td><td>48</td><td>46</td><td>45</td><td>43</td><td>42</td><td>41</td><td>40</td><td>39</td><td>38</td><td>37</td><td>35</td><td>33</td><td></td><td></td><td></td><td></td><td></td><td></td><td></td><td></td><td></td><td></td><td></td><td></td></tr> <tr><td></td><td></td><td></td><td></td><td>32</td><td>31</td><td>30</td><td></td><td></td><td>26</td><td>24</td><td>23</td><td>22</td><td>20</td><td></td><td></td><td></td><td></td><td></td><td></td><td></td><td></td><td></td><td></td><td></td><td></td><td></td><td></td></tr> <tr><td></td><td></td><td></td><td></td><td>16</td><td></td><td></td><td>13</td><td></td><td></td><td>10</td><td>9</td><td>8</td><td>7</td><td>6</td><td>5</td><td>4</td><td>3</td><td>2</td><td>1</td><td></td><td></td><td></td><td></td><td></td><td></td><td></td><td></td><td></td></tr> </table>																				68	67	66	65	64									59	58	57	55	54	53		51	50	49	48	46	45	43	42	41	40	39	38	37	35	33																	32	31	30			26	24	23	22	20																			16			13			10	9	8	7	6	5	4	3	2	1																																	
				68	67	66	65	64									59	58	57	55	54	53																																																																																																																																				
	51	50	49	48	46	45	43	42	41	40	39	38	37	35	33																																																																																																																																											
				32	31	30			26	24	23	22	20																																																																																																																																													
				16			13			10	9	8	7	6	5	4	3	2	1																																																																																																																																							

SEE NEXT PAGE FOR ADDITIONAL NUMBERS

ENTER DESCRIPTION EC NO: UAU2010-1551 DRAWN BY: DRWNAH01 CHECKED BY: CHKODRFFH APPROVED BY: APPR.VKOSHY DATE: 2010/03/15 DATE: 2008/05/09 DATE: 2010/03/18 F40	QUALITY SYMBOLS ▽=0 ▽=0	GENERAL TOLERANCES (UNLESS SPECIFIED) <table border="1"> <tr><th></th><th>mm</th><th>INCH</th></tr> <tr><td>4 PLACES</td><td>±---</td><td>±---</td></tr> <tr><td>3 PLACES</td><td>±---</td><td>±---</td></tr> <tr><td>2 PLACES</td><td>±---</td><td>±---</td></tr> <tr><td>1 PLACE</td><td>±---</td><td>±---</td></tr> </table>		mm	INCH	4 PLACES	±---	±---	3 PLACES	±---	±---	2 PLACES	±---	±---	1 PLACE	±---	±---	DIMENSION STYLE MM ONLY	SCALE 1:1	DESIGN UNITS METRIC	THIRD ANGLE PROJECTION
		mm	INCH																		
	4 PLACES	±---	±---																		
	3 PLACES	±---	±---																		
2 PLACES	±---	±---																			
1 PLACE	±---	±---																			
DRAFT WHERE APPLICABLE MUST REMAIN WITHIN DIMENSIONS	SEE BOM TABLE	MOLEX INCORPORATED	SD-34566-001	15 OF 36																	
THIS DRAWING CONTAINS INFORMATION THAT IS PROPRIETARY TO MOLEX INCORPORATED AND SHOULD NOT BE USED WITHOUT WRITTEN PERMISSION																					

20 19 18 17 16 15 14 13 12 11 10 9 8 7 6 5 4 3 2 1

STATUS	GM PART #	MATERIAL #	PART/MATERIAL REVISION	WIRE DRESS OPTION	KEY OPTION	COLOR (TPA)	NUMBERS INDICATE CAVITIES OPEN FOR CIRCUITS																	
AVAILABLE	NOT APPLICABLE	34566-1193	G	0	A	BLACK	72	71	69	68	67	66	64	63	62	60	59					54	53	
							52		49	48	46	44	43	42		39						34	33	
							73		32		29	27			23							17		
											14	13	12	11	9	8	7	6	5	4	3	2	1	
AVAILABLE	NOT APPLICABLE	34566-1213	G	0	A	BLACK	72	71	69	68	67	66	64	63	62		59					54	53	
							52		48	46	44	43	42		39							34	33	
							73		32		29	27			24	23						17		
											14	13	12	11	9	8			5	4	3	2	1	
AVAILABLE	NOT APPLICABLE	34566-1223	G	0	B	ST GRY				67	66	65	63	62		59	57	55				53		
										48			43	42		39	37	35				33		
							73					29	27	26		23	21					17		
												12			9	7								
AVAILABLE	NOT APPLICABLE	34566-1233	G	0	B	ST GRY				48	46		65		62		59	57	55			53		
														42		39	37	35				33		
							73					29	26			23	21					17		
													12		9	7								
AVAILABLE	NOT APPLICABLE	34566-1243	G	0	B	ST GRY			50	48	46						59	57	55			53		
																40	39	37	35			33		
							73									23	21					17		
										15			12				7	6	5	4	3			
AVAILABLE	NOT APPLICABLE	34566-1253	G	9	B	ST GRY			49	48			65			60	59	57	55			53		
																40	39	37	35			33		
							73									24	23	21					2	
AVAILABLE	NOT APPLICABLE	34566-1263	G	9	A	BLACK	72	71	69	68	67	66	64	63	62		59				56		53	
								50	48	46			44	43	42		39				36	35	33	
							73		32	30	29	27				24	23				20		17	
											14	13	12	11	9	8				5	4	3	2	1
AVAILABLE	NOT APPLICABLE	34566-1273	G	0	A	BLACK		70	69	68			65	64	63		61	59	58	57	56			
							52	50	49	48	47						41		38	37	36		34	33
							73		32	31	30	29	28	27		24	23				20	19	18	
										16			13	12	11	10	9						1	

ENTER DESCRIPTION EC NO: UAU2010-1551 DRAWN BY: 2010/03/15 CHKD BY: 2008/05/09 APPR: VKOSHY 2010/03/18 REV: T40	QUALITY SYMBOLS ▽=0 ▽=0	GENERAL TOLERANCES (UNLESS SPECIFIED) mm INCH 4 PLACES ±--- ±--- 3 PLACES ±--- ±--- 2 PLACES ±--- ±--- 1 PLACE ±--- ±--- ANGULAR ±---°	DIMENSION STYLE MM ONLY	SCALE 1:1	DESIGN UNITS METRIC	THIRD ANGLE PROJECTION
	DRAFT WHERE APPLICABLE MUST REMAIN WITHIN DIMENSIONS	SEE BOM TABLE	MATERIAL NO. SD-34566-001	DOCUMENT NO. SD-34566-001	SHEET NO. 17 OF 36	
	MOLEX INCORPORATED					
	THIS DRAWING CONTAINS INFORMATION THAT IS PROPRIETARY TO MOLEX INCORPORATED AND SHOULD NOT BE USED WITHOUT WRITTEN PERMISSION					

19 18 17 16 15 14 13 12 11 10 9 8 7 6 5 4 3 2 1

20 19 18 17 16 15 14 13 12 11 10 9 8 7 6 5 4 3 2 1

STATUS	GM PART #	MATERIAL #	PART/MATERIAL REVISION	WIRE DRESS OPTION	KEY OPTION	COLOR (TPA)	NUMBERS INDICATE CAVITIES OPEN FOR CIRCUITS																																																																															
AVAILABLE	NOT APPLICABLE	34566-1283	G	0	A	BLACK	<table border="1"> <tr><td>72</td><td>71</td><td>70</td><td>69</td><td>68</td><td>66</td><td>65</td><td>64</td><td>63</td><td>61</td><td>59</td><td>58</td><td>57</td><td>56</td><td>54</td></tr> <tr><td>52</td><td>50</td><td>49</td><td>48</td><td>47</td><td></td><td></td><td></td><td></td><td>42</td><td>41</td><td></td><td>38</td><td>37</td><td>36</td><td>34</td><td>33</td></tr> <tr><td colspan="2">73</td><td></td><td></td><td></td><td></td><td></td><td></td><td></td><td></td><td></td><td></td><td></td><td></td><td>20</td><td>19</td><td>18</td></tr> <tr><td></td><td></td><td></td><td></td><td>16</td><td></td><td></td><td>13</td><td>12</td><td>11</td><td>10</td><td>9</td><td></td><td></td><td></td><td></td><td></td></tr> </table>	72	71	70	69	68	66	65	64	63	61	59	58	57	56	54	52	50	49	48	47					42	41		38	37	36	34	33	73														20	19	18					16			13	12	11	10	9																		
72	71	70	69	68	66	65	64	63	61	59	58	57	56	54																																																																								
52	50	49	48	47					42	41		38	37	36	34	33																																																																						
73														20	19	18																																																																						
				16			13	12	11	10	9																																																																											
AVAILABLE	NOT APPLICABLE	34566-1293	G	0	A	BLACK	<table border="1"> <tr><td></td><td></td><td></td><td>68</td><td></td><td>65</td><td>64</td><td>63</td><td>61</td><td>59</td><td>58</td><td>56</td><td></td><td></td><td></td><td></td><td></td></tr> <tr><td>52</td><td>50</td><td></td><td>47</td><td></td><td></td><td></td><td></td><td>41</td><td></td><td>38</td><td>37</td><td>36</td><td>34</td><td>33</td><td></td><td></td></tr> <tr><td colspan="2">73</td><td></td><td></td><td></td><td></td><td></td><td></td><td></td><td>24</td><td>23</td><td></td><td>20</td><td>19</td><td>18</td><td>17</td><td>1</td></tr> <tr><td></td><td></td><td></td><td>16</td><td></td><td></td><td></td><td>13</td><td>12</td><td>11</td><td>10</td><td>9</td><td></td><td></td><td></td><td></td><td></td></tr> </table>				68		65	64	63	61	59	58	56						52	50		47					41		38	37	36	34	33			73									24	23		20	19	18	17	1				16				13	12	11	10	9																
			68		65	64	63	61	59	58	56																																																																											
52	50		47					41		38	37	36	34	33																																																																								
73									24	23		20	19	18	17	1																																																																						
			16				13	12	11	10	9																																																																											
AVAILABLE	NOT APPLICABLE	34566-1313	G	0	H	ST GRY	<table border="1"> <tr><td>80</td><td>78</td><td></td><td></td><td></td><td></td><td></td><td>72</td><td>71</td><td>70</td><td>69</td><td>68</td><td>66</td><td>65</td><td>64</td><td>63</td><td>61</td></tr> <tr><td></td><td>58</td><td>57</td><td>56</td><td>55</td><td>54</td><td>53</td><td></td><td></td><td></td><td></td><td></td><td>46</td><td>44</td><td>43</td><td>42</td><td></td></tr> <tr><td>40</td><td></td><td>37</td><td>35</td><td></td><td></td><td></td><td>32</td><td>30</td><td>29</td><td>27</td><td>26</td><td></td><td></td><td></td><td></td><td>21</td></tr> <tr><td>20</td><td>19</td><td>18</td><td>17</td><td></td><td>15</td><td></td><td>12</td><td></td><td></td><td>8</td><td>6</td><td>5</td><td></td><td>3</td><td>2</td><td></td></tr> </table>	80	78						72	71	70	69	68	66	65	64	63	61		58	57	56	55	54	53						46	44	43	42		40		37	35				32	30	29	27	26					21	20	19	18	17		15		12			8	6	5		3	2												
80	78						72	71	70	69	68	66	65	64	63	61																																																																						
	58	57	56	55	54	53						46	44	43	42																																																																							
40		37	35				32	30	29	27	26					21																																																																						
20	19	18	17		15		12			8	6	5		3	2																																																																							
AVAILABLE	NOT APPLICABLE	34566-1323	G	0	A	BLACK	<table border="1"> <tr><td>72</td><td>71</td><td>70</td><td>69</td><td>68</td><td>67</td><td>66</td><td>65</td><td>64</td><td>63</td><td>62</td><td>60</td><td>59</td><td>58</td><td>57</td><td>56</td><td>55</td><td>54</td><td>53</td></tr> <tr><td>52</td><td>51</td><td>50</td><td>49</td><td>48</td><td>47</td><td>46</td><td>45</td><td>44</td><td>43</td><td>42</td><td>41</td><td>40</td><td>39</td><td>38</td><td>37</td><td>36</td><td>35</td><td>34</td><td>33</td></tr> <tr><td colspan="2">73</td><td></td><td></td><td></td><td></td><td></td><td></td><td></td><td></td><td></td><td></td><td></td><td></td><td></td><td></td><td></td><td></td><td></td><td></td></tr> <tr><td></td><td></td><td></td><td></td><td>16</td><td>15</td><td>14</td><td>13</td><td>12</td><td>11</td><td>10</td><td>9</td><td>8</td><td>7</td><td>6</td><td>5</td><td>4</td><td>3</td><td>2</td><td>1</td></tr> </table>	72	71	70	69	68	67	66	65	64	63	62	60	59	58	57	56	55	54	53	52	51	50	49	48	47	46	45	44	43	42	41	40	39	38	37	36	35	34	33	73																								16	15	14	13	12	11	10	9	8	7	6	5	4	3	2	1
72	71	70	69	68	67	66	65	64	63	62	60	59	58	57	56	55	54	53																																																																				
52	51	50	49	48	47	46	45	44	43	42	41	40	39	38	37	36	35	34	33																																																																			
73																																																																																						
				16	15	14	13	12	11	10	9	8	7	6	5	4	3	2	1																																																																			
AVAILABLE	NOT APPLICABLE	34566-1333	G	0	A	BLACK	<table border="1"> <tr><td></td><td>70</td><td>69</td><td>68</td><td></td><td>65</td><td>64</td><td></td><td></td><td></td><td>59</td><td>58</td><td>56</td><td></td><td></td><td></td><td></td><td></td><td></td></tr> <tr><td>52</td><td>50</td><td>49</td><td>47</td><td></td><td></td><td></td><td></td><td></td><td>41</td><td></td><td>38</td><td>37</td><td>36</td><td>34</td><td></td><td></td><td></td><td></td></tr> <tr><td colspan="2">73</td><td></td><td></td><td></td><td></td><td></td><td></td><td></td><td></td><td></td><td>23</td><td></td><td>20</td><td>19</td><td>18</td><td>17</td><td></td><td></td></tr> <tr><td></td><td></td><td></td><td>16</td><td></td><td></td><td></td><td>13</td><td>12</td><td>11</td><td>10</td><td>9</td><td>8</td><td>6</td><td></td><td></td><td></td><td></td><td></td></tr> </table>		70	69	68		65	64				59	58	56							52	50	49	47						41		38	37	36	34					73											23		20	19	18	17						16				13	12	11	10	9	8	6								
	70	69	68		65	64				59	58	56																																																																										
52	50	49	47						41		38	37	36	34																																																																								
73											23		20	19	18	17																																																																						
			16				13	12	11	10	9	8	6																																																																									
AVAILABLE	NOT APPLICABLE	34566-1343	G	0	A	BLACK	<table border="1"> <tr><td>72</td><td>71</td><td></td><td>69</td><td>67</td><td>65</td><td>64</td><td>63</td><td></td><td></td><td>59</td><td>58</td><td>57</td><td>56</td><td></td><td></td><td></td><td></td><td></td></tr> <tr><td></td><td>50</td><td>49</td><td>48</td><td>47</td><td></td><td></td><td></td><td></td><td>41</td><td></td><td>38</td><td>37</td><td>36</td><td>34</td><td></td><td></td><td></td><td></td></tr> <tr><td colspan="2">73</td><td></td><td></td><td></td><td></td><td></td><td></td><td></td><td></td><td></td><td>23</td><td></td><td>20</td><td>19</td><td>18</td><td>17</td><td></td><td></td></tr> <tr><td></td><td></td><td></td><td>16</td><td></td><td></td><td></td><td>13</td><td>12</td><td>11</td><td>10</td><td>9</td><td>7</td><td>6</td><td>4</td><td>3</td><td>2</td><td>1</td><td></td></tr> </table>	72	71		69	67	65	64	63			59	58	57	56							50	49	48	47					41		38	37	36	34					73											23		20	19	18	17						16				13	12	11	10	9	7	6	4	3	2	1				
72	71		69	67	65	64	63			59	58	57	56																																																																									
	50	49	48	47					41		38	37	36	34																																																																								
73											23		20	19	18	17																																																																						
			16				13	12	11	10	9	7	6	4	3	2	1																																																																					
AVAILABLE	NOT APPLICABLE	34566-1353	G	0	H	ST GRY	<table border="1"> <tr><td>79</td><td>78</td><td>77</td><td>76</td><td>75</td><td>74</td><td>73</td><td>72</td><td>71</td><td>70</td><td>69</td><td>68</td><td>66</td><td>65</td><td>64</td><td>63</td><td>61</td></tr> <tr><td>60</td><td>59</td><td>58</td><td>57</td><td>56</td><td></td><td>53</td><td></td><td>50</td><td></td><td></td><td></td><td></td><td></td><td>44</td><td>43</td><td>41</td></tr> <tr><td>40</td><td>39</td><td>38</td><td>37</td><td></td><td>35</td><td>34</td><td>32</td><td>30</td><td>29</td><td>27</td><td>26</td><td></td><td></td><td></td><td></td><td>22</td><td>21</td></tr> <tr><td>20</td><td>19</td><td>18</td><td>17</td><td></td><td></td><td></td><td>13</td><td>12</td><td>11</td><td></td><td>8</td><td>6</td><td>5</td><td></td><td>3</td><td>2</td><td></td></tr> </table>	79	78	77	76	75	74	73	72	71	70	69	68	66	65	64	63	61	60	59	58	57	56		53		50						44	43	41	40	39	38	37		35	34	32	30	29	27	26					22	21	20	19	18	17				13	12	11		8	6	5		3	2										
79	78	77	76	75	74	73	72	71	70	69	68	66	65	64	63	61																																																																						
60	59	58	57	56		53		50						44	43	41																																																																						
40	39	38	37		35	34	32	30	29	27	26					22	21																																																																					
20	19	18	17				13	12	11		8	6	5		3	2																																																																						
AVAILABLE	NOT APPLICABLE	34566-1363	G	0	A	BLACK	<table border="1"> <tr><td>72</td><td>71</td><td></td><td>69</td><td>68</td><td>67</td><td>66</td><td>64</td><td>63</td><td>62</td><td></td><td>59</td><td></td><td></td><td></td><td></td><td></td><td></td><td>53</td></tr> <tr><td></td><td></td><td></td><td>48</td><td>46</td><td></td><td></td><td>44</td><td>43</td><td>42</td><td></td><td>39</td><td></td><td></td><td></td><td></td><td></td><td></td><td>33</td></tr> <tr><td colspan="2">73</td><td></td><td></td><td></td><td></td><td></td><td></td><td></td><td></td><td></td><td>24</td><td>23</td><td></td><td></td><td></td><td></td><td></td><td></td></tr> <tr><td></td><td></td><td></td><td></td><td></td><td>14</td><td>13</td><td>12</td><td>11</td><td></td><td>9</td><td>8</td><td></td><td></td><td>5</td><td>4</td><td>3</td><td>2</td><td>1</td></tr> </table>	72	71		69	68	67	66	64	63	62		59							53				48	46			44	43	42		39							33	73											24	23												14	13	12	11		9	8			5	4	3	2	1			
72	71		69	68	67	66	64	63	62		59							53																																																																				
			48	46			44	43	42		39							33																																																																				
73											24	23																																																																										
					14	13	12	11		9	8			5	4	3	2	1																																																																				

ENTER DESCRIPTION EC NO: UAU2010-1551 DRAWN BY: SRAJENDRANAT CHECKED BY: TSK IVER APPROVED BY: VKOSHY DATE: 2010/03/18 APPR: VKOSHY DATE: 2010/03/18 REV: F40	QUALITY SYMBOLS ▽=0 ▽=0	GENERAL TOLERANCES (UNLESS SPECIFIED) <table border="1"> <tr><th></th><th>mm</th><th>INCH</th></tr> <tr><td>4 PLACES</td><td>±---</td><td>±---</td></tr> <tr><td>3 PLACES</td><td>±---</td><td>±---</td></tr> <tr><td>2 PLACES</td><td>±---</td><td>±---</td></tr> <tr><td>1 PLACE</td><td>±---</td><td>±---</td></tr> </table> ANGULAR ±---°		mm	INCH	4 PLACES	±---	±---	3 PLACES	±---	±---	2 PLACES	±---	±---	1 PLACE	±---	±---	DIMENSION STYLE MM ONLY	SCALE 1:1	DESIGN UNITS METRIC	THIRD ANGLE PROJECTION
		mm	INCH																		
	4 PLACES	±---	±---																		
	3 PLACES	±---	±---																		
2 PLACES	±---	±---																			
1 PLACE	±---	±---																			
DRAFT WHERE APPLICABLE MUST REMAIN WITHIN DIMENSIONS	SEE BOM TABLE	MATERIAL NO. SD-34566-001	DOCUMENT NO. SD-34566-001	SHEET NO. 18 OF 36	MOLEX INCORPORATED																
THIS DRAWING CONTAINS INFORMATION THAT IS PROPRIETARY TO MOLEX INCORPORATED AND SHOULD NOT BE USED WITHOUT WRITTEN PERMISSION																					
MX123 73/80 CKT HRNS CONN ASSY																					

19 18 17 16 15 14 13 12 11 10 9 8 7 6 5 4 3 2 1

20 19 18 17 16 15 14 13 12 11 10 9 8 7 6 5 4 3 2 1

STATUS	GM PART #	MATERIAL #	PART/MATERIAL REVISION	WIRE DRESS OPTION	KEY OPTION	COLOR (TPA)	NUMBERS INDICATE CAVITIES OPEN FOR CIRCUITS																
AVAILABLE	NOT APPLICABLE	34566-1473	G	0	A	BLACK	72	71	69	68	67	66	64	63	62	59					54	53	
							52		49	48	46	44	43	42	39					34	33		
								73													17		
											14	13	12	11	9	8	7	6	5	4	3	2	1
AVAILABLE	NOT APPLICABLE	34566-1483	G	0	A	BLACK	72	71	69	68		65	64	63	61	59	58		56				
							52	50	49	47					41		38	37	36		34	33	
								73		32	31	30	29	28	27	24	23		20	19	18	17	
									16			13	12	11	10	9						1	
AVAILABLE	NOT APPLICABLE	34566-1493	G	0	B	ST GRY				68						59	58	57		55	53		
									49	48	46					39	38	37		35	33		
								73				29				23	22	21		18	17		
												12	11	10	7							1	
AVAILABLE	NOT APPLICABLE	34566-1513	G	0	B	ST GRY						65				59	58	57		55	53		
									49	48	46					39	37	35		33			
								73				29				23	21			17			
												12			7								
AVAILABLE	NOT APPLICABLE	34566-1523	G	0	A	BLACK		70	69	68		65	64			59	58		56		54		
							52	50	49	47				42	41		38	37	36		34		
								73		32	31	30	29	28	27	26	23		20	19	18	17	
									16			13	12	11	10	9	8					1	
AVAILABLE	NOT APPLICABLE	34566-1533	G	0	A	BLACK	72	71	70	69	68		65	64	63	61	59	58	57	56			
							52	51	50	49	47					41		38	37	36		34	33
								73		32	31	30	29	28	27		24	23		20	19	18	17
									16			13	12	11	10	9				3	2	1	
AVAILABLE	NOT APPLICABLE	34566-1543	G	0	B	ST GRY			69	68	66					59	57		55	53			
									49	48	46					39	37		35	33			
								73				29				23	21						
													11	10	7								
AVAILABLE	NOT APPLICABLE	34566-1583	G	0	A	BLACK		70		67	66	65			61		58	57		55	54		
									49	47	45	44	43	42	41	39		37		34			
								73		32	30		27	25	24		21	20	19	18	17		
										15	13		11		9	8	6	5		3		1	

ENTER DESCRIPTION EC NO: UAU2010-1551 DRAWN BY: DRWN:AM01 CHECKED BY: CHKD:GRFF:HS APPROVED BY: APPR:VKOSHY DATE: 2010/03/15 DATE: 2008/05/09 DATE: 2010/03/18 REV: F40	QUALITY SYMBOLS ▽=0 ▽=0	GENERAL TOLERANCES (UNLESS SPECIFIED) <table border="1"> <tr> <th></th> <th>mm</th> <th>INCH</th> </tr> <tr> <td>4 PLACES</td> <td>±---</td> <td>±---</td> </tr> <tr> <td>3 PLACES</td> <td>±---</td> <td>±---</td> </tr> <tr> <td>2 PLACES</td> <td>±---</td> <td>±---</td> </tr> <tr> <td>1 PLACE</td> <td>±---</td> <td>±---</td> </tr> </table>		mm	INCH	4 PLACES	±---	±---	3 PLACES	±---	±---	2 PLACES	±---	±---	1 PLACE	±---	±---	DIMENSION STYLE MM ONLY	SCALE 1:1	DESIGN UNITS METRIC	THIRD ANGLE PROJECTION
		mm	INCH																		
	4 PLACES	±---	±---																		
	3 PLACES	±---	±---																		
2 PLACES	±---	±---																			
1 PLACE	±---	±---																			
		DRAFT WHERE APPLICABLE MUST REMAIN WITHIN DIMENSIONS	DRAWN BY SRAJENDRANAT DATE 2008/05/09	CHECKED BY TSKIVER DATE 2008/05/09	APPROVED BY VKOSHY DATE 2010/03/18	TITLE MX123 73/80 CKT HRNS CONN ASSY															
			MATERIAL NO. SEE BOM TABLE	DOCUMENT NO. SD-34566-001	SHEET NO. 20 OF 36	MOLEX INCORPORATED															
			THIS DRAWING CONTAINS INFORMATION THAT IS PROPRIETARY TO MOLEX INCORPORATED AND SHOULD NOT BE USED WITHOUT WRITTEN PERMISSION																		

19 18 17 16 15 14 13 12 11 10 9 8 7 6 5 4 3 2 1

20 19 18 17 16 15 14 13 12 11 10 9 8 7 6 5 4 3 2 1

STATUS	GM PART #	MATERIAL #	PART / MATERIAL REVISION	WIRE DRESS OPTION	KEY OPTION	COLOR (TPA)	NUMBERS INDICATE CAVITIES OPEN FOR CIRCUITS																		
AVAILABLE	NOT APPLICABLE	34566-1773	G	0	C	BLUE	72	70		67	66		63	62		59	57					53			
							52	51			46	44		42	40	39						34	33		
									73			30		27	26	25		22	21	20					
											15	14			10	9		6	5	4					
AVAILABLE	NOT APPLICABLE	34566-1783	G	0	C	BLUE	72	70		67	66		63	62		59	57					53			
							52	51			46	44		42	40	39						34	33		
									73			30		26	25		22	21	20						
											15	14			10	9		6	5	4					
AVAILABLE	NOT APPLICABLE	34566-1793	G	0	A	BLACK			69				63	62	61		58	57	56	55	54	53			
							52	51	49				44	43	42	41			37	36	35	34	33		
										73		32		29	28	27	26					19	18		
											16		13	12	11	10						3			
AVAILABLE	NOT APPLICABLE	34566-1813	G	0	B	ST GRAY	72	71	70	68	67	66		62	61	60	59	58	57	56	55	54	53		
							52	51	50	48	47	46		42	41	40	39	38	37	36	35	34	33		
									73				32	31	30	29	28	27	26	25	24	23			
											16	15	14	13		10	9	8							
AVAILABLE	NOT APPLICABLE	34566-1823	G	0	A	BLACK	72	71	70	69	68	67	66	65	64		61	59	58	56	55	54	53		
							52	51	50	49	47			42	41			38	37	36		34	33		
									73		32	31	30	29	28	27	26	24	23	22	21	20	19		
											16		13	12	11	10	9	8				1			
AVAILABLE	NOT APPLICABLE	34566-1833	G	0	A	BLACK				68		65	63	61	59	58	56					34	33		
							52	51	50		47			41			38	37	36			34	33		
									73		32	31	30	29	28	27	25	24	23			20	19		
											16		13	12	11	10						18	17		
AVAILABLE	NOT APPLICABLE	34566-1843	G	0	A	BLACK				68		65	63	61	59	58	56					53			
							52	51	50		47			41			38	37	36			34	33		
									73		32	31	30	29	28	27	24	23	22	21	20	19	18		
											16	15	14	13	12	11	10					1			
AVAILABLE	NOT APPLICABLE	34566-1853	G	0	A	BLACK	72	71	70	69	68	67	66	65	64	63	61	60		57	56	55	54	53	
							52	51	50	49	48	47		44	43	41	40			37	36	35	34	33	
									73				30	29	28		25	24		21	20	19	18	17	
											16	15			11	10	9	8	7	6	5	4	3	2	1
AVAILABLE	NOT APPLICABLE	34566-1863	G	0	B	ST GRAY				68	67	66	65	64	63										
											32	30	29	28	27									17	
											16					10									

ENTER DESCRIPTION EC NO: UAU2010-1551 DRAWN BY: DRWNAH01 CHECKED BY: CHKDRFF1 APPROVED BY: APPR.VKOSHY DATE: 2010/03/15 DATE: 2008/05/09 DATE: 2010/03/18	QUALITY SYMBOLS ▽=0 ▽=0	GENERAL TOLERANCES (UNLESS SPECIFIED) <table border="1"> <tr> <th></th> <th>mm</th> <th>INCH</th> </tr> <tr> <td>4 PLACES</td> <td>±---</td> <td>±---</td> </tr> <tr> <td>3 PLACES</td> <td>±---</td> <td>±---</td> </tr> <tr> <td>2 PLACES</td> <td>±---</td> <td>±---</td> </tr> <tr> <td>1 PLACE</td> <td>±---</td> <td>±---</td> </tr> </table>		mm	INCH	4 PLACES	±---	±---	3 PLACES	±---	±---	2 PLACES	±---	±---	1 PLACE	±---	±---	DIMENSION STYLE MM ONLY	SCALE 1:1	DESIGN UNITS METRIC	THIRD ANGLE PROJECTION
		mm	INCH																		
	4 PLACES	±---	±---																		
	3 PLACES	±---	±---																		
2 PLACES	±---	±---																			
1 PLACE	±---	±---																			
DESCRIPTION 740	DRAFT WHERE APPLICABLE MUST REMAIN WITHIN DIMENSIONS	DRAWN BY SRAJENDRANAT DATE 2008/05/09	CHECKED BY TSKIVER DATE 2008/05/09	APPROVED BY VKOSHY DATE 2010/03/18	TITLE MX123 73/80 CKT HRNS CONN ASSY																
MATERIAL NO. SEE BOM TABLE	DOCUMENT NO. SD-34566-001	SHEET NO. 23 OF 36	MOLEX INCORPORATED																		
THIS DRAWING CONTAINS INFORMATION THAT IS PROPRIETARY TO MOLEX INCORPORATED AND SHOULD NOT BE USED WITHOUT WRITTEN PERMISSION																					

19 18 17 16 15 14 13 12 11 10 9 8 7 6 5 4 3 2 1

20	19	18	17	16	15	14	13	12	11	10	9	8	7	6	5	4	3	2	1																																																																																		
										STATUS	GM PART #	MATERIAL #	PART/MATERIAL REVISION	WIRE DRESS OPTION	KEY OPTION	COLOR (TPA)	NUMBERS INDICATE CAVITIES OPEN FOR CIRCUITS																																																																																				
										AVAILABLE	NOT APPLICABLE	34566-1873	G	0	C	BLUE	<table border="1"> <tr><td>72</td><td>70</td><td></td><td></td><td>67</td><td>66</td><td></td><td></td><td>63</td><td>62</td><td></td><td></td><td>59</td><td>57</td><td></td><td></td><td></td><td></td><td></td><td>53</td></tr> <tr><td>52</td><td>51</td><td></td><td></td><td></td><td>46</td><td></td><td>44</td><td>42</td><td></td><td>40</td><td>39</td><td></td><td></td><td></td><td></td><td></td><td></td><td></td><td>34</td><td>33</td></tr> <tr><td colspan="2">73</td><td></td><td></td><td>32</td><td>30</td><td></td><td></td><td>27</td><td>26</td><td>25</td><td></td><td></td><td>22</td><td>21</td><td>20</td><td></td><td></td><td></td><td></td></tr> <tr><td colspan="2"></td><td></td><td></td><td>15</td><td>14</td><td></td><td></td><td></td><td>10</td><td>9</td><td></td><td></td><td>6</td><td>5</td><td>4</td><td></td><td></td><td></td><td></td></tr> </table>	72	70			67	66			63	62			59	57						53	52	51				46		44	42		40	39								34	33	73				32	30			27	26	25			22	21	20									15	14				10	9			6	5	4							
72	70			67	66			63	62			59	57						53																																																																																		
52	51				46		44	42		40	39								34	33																																																																																	
73				32	30			27	26	25			22	21	20																																																																																						
				15	14				10	9			6	5	4																																																																																						
										AVAILABLE	NOT APPLICABLE	34566-1883	G	0	A	BLACK	<table border="1"> <tr><td></td><td>70</td><td>68</td><td>67</td><td>66</td><td>65</td><td></td><td></td><td></td><td></td><td></td><td></td><td></td><td>58</td><td>57</td><td>55</td><td></td><td></td><td></td><td></td></tr> <tr><td></td><td></td><td>49</td><td>47</td><td></td><td></td><td>44</td><td>43</td><td>42</td><td>41</td><td>40</td><td>39</td><td></td><td>37</td><td>35</td><td></td><td></td><td></td><td></td><td></td></tr> <tr><td colspan="2">73</td><td></td><td>32</td><td>30</td><td></td><td></td><td>27</td><td>25</td><td>24</td><td></td><td></td><td></td><td>21</td><td>20</td><td>19</td><td>18</td><td>17</td><td></td><td></td></tr> <tr><td colspan="2"></td><td></td><td>16</td><td>15</td><td>13</td><td></td><td></td><td>10</td><td>9</td><td>8</td><td></td><td></td><td>6</td><td>5</td><td>4</td><td></td><td></td><td></td><td></td></tr> </table>		70	68	67	66	65								58	57	55							49	47			44	43	42	41	40	39		37	35						73			32	30			27	25	24				21	20	19	18	17						16	15	13			10	9	8			6	5	4								
	70	68	67	66	65								58	57	55																																																																																						
		49	47			44	43	42	41	40	39		37	35																																																																																							
73			32	30			27	25	24				21	20	19	18	17																																																																																				
			16	15	13			10	9	8			6	5	4																																																																																						
										AVAILABLE	NOT APPLICABLE	34566-1893	G	0	C	BLUE	<table border="1"> <tr><td>72</td><td>70</td><td></td><td></td><td>66</td><td></td><td>63</td><td></td><td></td><td></td><td>59</td><td>57</td><td></td><td></td><td></td><td></td><td></td><td></td><td></td><td>53</td></tr> <tr><td>52</td><td>51</td><td></td><td></td><td>46</td><td></td><td>44</td><td>42</td><td></td><td>40</td><td>39</td><td></td><td></td><td></td><td></td><td></td><td></td><td></td><td></td><td>34</td><td>33</td></tr> <tr><td colspan="2">73</td><td></td><td></td><td>32</td><td>30</td><td></td><td>27</td><td>26</td><td>25</td><td></td><td></td><td></td><td>22</td><td>21</td><td>20</td><td></td><td></td><td></td><td></td></tr> <tr><td colspan="2"></td><td></td><td></td><td>15</td><td>14</td><td></td><td></td><td>10</td><td>9</td><td></td><td></td><td></td><td>6</td><td>5</td><td>4</td><td></td><td></td><td></td><td></td></tr> </table>	72	70			66		63				59	57								53	52	51			46		44	42		40	39									34	33	73				32	30		27	26	25				22	21	20									15	14			10	9				6	5	4							
72	70			66		63				59	57								53																																																																																		
52	51			46		44	42		40	39									34	33																																																																																	
73				32	30		27	26	25				22	21	20																																																																																						
				15	14			10	9				6	5	4																																																																																						
										AVAILABLE	NOT APPLICABLE	34566-1913	G	0	B	ST GRY	<table border="1"> <tr><td>72</td><td>70</td><td>68</td><td>66</td><td></td><td></td><td></td><td></td><td></td><td></td><td>60</td><td>59</td><td></td><td></td><td></td><td></td><td></td><td></td><td>55</td><td>54</td><td>53</td></tr> <tr><td>52</td><td>50</td><td>48</td><td>46</td><td></td><td></td><td></td><td></td><td></td><td></td><td>40</td><td>39</td><td></td><td></td><td></td><td></td><td></td><td></td><td>35</td><td>34</td><td>33</td></tr> <tr><td colspan="2">73</td><td></td><td>32</td><td>31</td><td>30</td><td>29</td><td>28</td><td>27</td><td>26</td><td>25</td><td>24</td><td></td><td></td><td></td><td></td><td></td><td></td><td></td><td></td><td></td></tr> <tr><td colspan="2"></td><td></td><td>16</td><td></td><td></td><td></td><td></td><td></td><td>10</td><td>9</td><td>8</td><td></td><td></td><td></td><td></td><td></td><td></td><td></td><td></td><td></td></tr> </table>	72	70	68	66							60	59							55	54	53	52	50	48	46							40	39							35	34	33	73			32	31	30	29	28	27	26	25	24													16						10	9	8									
72	70	68	66							60	59							55	54	53																																																																																	
52	50	48	46							40	39							35	34	33																																																																																	
73			32	31	30	29	28	27	26	25	24																																																																																										
			16						10	9	8																																																																																										
										AVAILABLE	NOT APPLICABLE	34566-1923	G	0	A	BLACK	<table border="1"> <tr><td></td><td></td><td>69</td><td></td><td></td><td></td><td>63</td><td></td><td></td><td></td><td></td><td></td><td></td><td>58</td><td>56</td><td>55</td><td>54</td><td>53</td><td></td><td></td></tr> <tr><td>52</td><td>51</td><td>49</td><td></td><td></td><td></td><td>44</td><td>43</td><td>42</td><td>41</td><td></td><td></td><td></td><td></td><td></td><td></td><td>36</td><td>35</td><td>34</td><td>33</td></tr> <tr><td colspan="2">73</td><td></td><td>32</td><td></td><td></td><td>28</td><td></td><td>26</td><td></td><td></td><td></td><td></td><td></td><td></td><td></td><td>19</td><td>18</td><td></td><td></td></tr> <tr><td colspan="2"></td><td></td><td>16</td><td></td><td></td><td>12</td><td></td><td>10</td><td></td><td></td><td></td><td></td><td></td><td></td><td></td><td>3</td><td></td><td></td><td></td></tr> </table>			69				63							58	56	55	54	53			52	51	49				44	43	42	41							36	35	34	33	73			32			28		26								19	18						16			12		10								3							
		69				63							58	56	55	54	53																																																																																				
52	51	49				44	43	42	41							36	35	34	33																																																																																		
73			32			28		26								19	18																																																																																				
			16			12		10								3																																																																																					
										AVAILABLE	NOT APPLICABLE	34566-1933	G	0	A	BLACK	<table border="1"> <tr><td></td><td>70</td><td></td><td></td><td>67</td><td>66</td><td>65</td><td></td><td></td><td></td><td></td><td></td><td></td><td>58</td><td>57</td><td>55</td><td></td><td></td><td></td><td></td></tr> <tr><td></td><td></td><td>49</td><td></td><td>47</td><td></td><td></td><td>44</td><td>43</td><td>42</td><td>41</td><td>40</td><td>39</td><td></td><td>37</td><td>35</td><td></td><td></td><td></td><td></td></tr> <tr><td colspan="2">73</td><td></td><td></td><td>32</td><td>30</td><td></td><td></td><td>27</td><td>25</td><td>24</td><td></td><td></td><td>21</td><td>20</td><td>19</td><td>18</td><td>17</td><td></td><td></td></tr> <tr><td colspan="2"></td><td></td><td></td><td>16</td><td>15</td><td>13</td><td></td><td></td><td>10</td><td>9</td><td>8</td><td></td><td>6</td><td>5</td><td>4</td><td></td><td></td><td></td><td></td></tr> </table>		70			67	66	65							58	57	55							49		47			44	43	42	41	40	39		37	35					73				32	30			27	25	24			21	20	19	18	17							16	15	13			10	9	8		6	5	4								
	70			67	66	65							58	57	55																																																																																						
		49		47			44	43	42	41	40	39		37	35																																																																																						
73				32	30			27	25	24			21	20	19	18	17																																																																																				
				16	15	13			10	9	8		6	5	4																																																																																						
										AVAILABLE	NOT APPLICABLE	34566-1943	G	0	A	BLACK	<table border="1"> <tr><td></td><td>70</td><td></td><td></td><td>67</td><td>66</td><td>65</td><td></td><td></td><td></td><td></td><td></td><td></td><td>58</td><td>57</td><td>55</td><td></td><td></td><td></td><td></td></tr> <tr><td>51</td><td>49</td><td></td><td></td><td>47</td><td></td><td></td><td>44</td><td>43</td><td>42</td><td>41</td><td>40</td><td>39</td><td></td><td>37</td><td>35</td><td></td><td></td><td></td><td></td></tr> <tr><td colspan="2">73</td><td></td><td></td><td>32</td><td>30</td><td></td><td></td><td>27</td><td>25</td><td>24</td><td></td><td></td><td>21</td><td>20</td><td>19</td><td>18</td><td>17</td><td></td><td></td></tr> <tr><td colspan="2"></td><td></td><td></td><td>16</td><td>15</td><td>13</td><td></td><td></td><td>10</td><td>9</td><td>8</td><td></td><td>6</td><td>5</td><td>4</td><td></td><td></td><td></td><td></td></tr> </table>		70			67	66	65							58	57	55					51	49			47			44	43	42	41	40	39		37	35					73				32	30			27	25	24			21	20	19	18	17							16	15	13			10	9	8		6	5	4								
	70			67	66	65							58	57	55																																																																																						
51	49			47			44	43	42	41	40	39		37	35																																																																																						
73				32	30			27	25	24			21	20	19	18	17																																																																																				
				16	15	13			10	9	8		6	5	4																																																																																						
										AVAILABLE	NOT APPLICABLE	34566-1953	G	0	C	BLUE	<table border="1"> <tr><td>72</td><td>70</td><td></td><td></td><td>66</td><td></td><td>63</td><td></td><td></td><td></td><td>59</td><td>57</td><td></td><td></td><td></td><td></td><td></td><td></td><td></td><td>53</td></tr> <tr><td>52</td><td>51</td><td></td><td></td><td>48</td><td>47</td><td>46</td><td>44</td><td>42</td><td></td><td>40</td><td>39</td><td></td><td></td><td></td><td></td><td></td><td></td><td></td><td>34</td><td>33</td></tr> <tr><td colspan="2">73</td><td></td><td></td><td></td><td>30</td><td></td><td></td><td>26</td><td>25</td><td></td><td></td><td></td><td>22</td><td>21</td><td>20</td><td></td><td></td><td></td><td></td></tr> <tr><td colspan="2"></td><td></td><td></td><td>15</td><td>14</td><td></td><td></td><td></td><td>10</td><td>9</td><td></td><td></td><td>6</td><td>5</td><td>4</td><td></td><td></td><td></td><td></td></tr> </table>	72	70			66		63				59	57								53	52	51			48	47	46	44	42		40	39								34	33	73					30			26	25				22	21	20									15	14				10	9			6	5	4							
72	70			66		63				59	57								53																																																																																		
52	51			48	47	46	44	42		40	39								34	33																																																																																	
73					30			26	25				22	21	20																																																																																						
				15	14				10	9			6	5	4																																																																																						
										AVAILABLE	NOT APPLICABLE	34566-1963	G	0	C	BLUE	<table border="1"> <tr><td>72</td><td>70</td><td></td><td></td><td>66</td><td></td><td>63</td><td></td><td></td><td></td><td>59</td><td>57</td><td></td><td></td><td></td><td></td><td></td><td></td><td></td><td>53</td></tr> <tr><td>52</td><td>51</td><td></td><td></td><td>46</td><td></td><td>44</td><td>42</td><td></td><td>40</td><td>39</td><td></td><td></td><td></td><td></td><td></td><td></td><td></td><td></td><td>34</td><td>33</td></tr> <tr><td colspan="2">73</td><td></td><td></td><td>30</td><td></td><td></td><td>26</td><td>25</td><td></td><td></td><td></td><td></td><td>22</td><td>21</td><td>20</td><td></td><td></td><td></td><td></td></tr> <tr><td colspan="2"></td><td></td><td></td><td>15</td><td>14</td><td></td><td></td><td>10</td><td>9</td><td></td><td></td><td></td><td>6</td><td>5</td><td>4</td><td></td><td></td><td></td><td></td></tr> </table>	72	70			66		63				59	57								53	52	51			46		44	42		40	39									34	33	73				30			26	25					22	21	20									15	14			10	9				6	5	4							
72	70			66		63				59	57								53																																																																																		
52	51			46		44	42		40	39									34	33																																																																																	
73				30			26	25					22	21	20																																																																																						
				15	14			10	9				6	5	4																																																																																						

ENTER DESCRIPTION EC NO: UAU2010-1551 DRAWN BY: DRWNAH01 CHECKED BY: CHKDRFF1HS APPROVED BY: APPR.VKOSHY DATE: 2010/03/15 DATE: 2008/05/09 DATE: 2010/03/18 REV: F40	QUALITY SYMBOLS ▽=0 ▽=0	GENERAL TOLERANCES (UNLESS SPECIFIED) <table border="1"> <tr><th></th><th>mm</th><th>INCH</th></tr> <tr><td>4 PLACES</td><td>±---</td><td>±---</td></tr> <tr><td>3 PLACES</td><td>±---</td><td>±---</td></tr> <tr><td>2 PLACES</td><td>±---</td><td>±---</td></tr> <tr><td>1 PLACE</td><td>±---</td><td>±---</td></tr> </table> ANGULAR ±---°		mm	INCH	4 PLACES	±---	±---	3 PLACES	±---	±---	2 PLACES	±---	±---	1 PLACE	±---	±---	DIMENSION STYLE MM ONLY	SCALE 1:1	DESIGN UNITS METRIC	THIRD ANGLE PROJECTION
		mm	INCH																		
	4 PLACES	±---	±---																		
	3 PLACES	±---	±---																		
2 PLACES	±---	±---																			
1 PLACE	±---	±---																			
DRAFT WHERE APPLICABLE MUST REMAIN WITHIN DIMENSIONS	DRAWN BY SRAJENDRANAT 2008/05/09	CHECKED BY TSKIVER 2008/05/09	DATE DATE	DATE DATE	DATE DATE	TITLE MX123 73/80 CKT HRNS CONN ASSY															
SEE BOM TABLE	APPROVED BY VKOSHY 2010/03/18	DATE DATE	DATE DATE	DATE DATE	DATE DATE	MOLEX INCORPORATED															
MATERIAL NO. SD-34566-001	DOCUMENT NO. SD-34566-001	SHEET NO. 24 OF 36	THIS DRAWING CONTAINS INFORMATION THAT IS PROPRIETARY TO MOLEX INCORPORATED AND SHOULD NOT BE USED WITHOUT WRITTEN PERMISSION																		

20	19	18	17	16	15	14	13	12	11	10	9	8	7	6	5	4	3	2	1																																																																																																					
										STATUS	GM PART #	MATERIAL #	PART/MATERIAL REVISION	WIRE DRESS OPTION	KEY OPTION	COLOR (TPA)	NUMBERS INDICATE CAVITIES OPEN FOR CIRCUITS																																																																																																							
										AVAILABLE	NOT APPLICABLE	34566-2193	G	0	A	BLACK	<table border="1"> <tr><td></td><td></td><td>70</td><td></td><td></td><td>67</td><td>66</td><td>65</td><td></td><td></td><td></td><td></td><td></td><td></td><td></td><td></td><td></td><td></td><td>58</td><td>57</td><td>55</td><td></td><td></td></tr> <tr><td></td><td></td><td>49</td><td></td><td></td><td>47</td><td></td><td></td><td>44</td><td>43</td><td>42</td><td>41</td><td></td><td></td><td></td><td></td><td></td><td></td><td>39</td><td></td><td>37</td><td></td><td></td></tr> <tr><td></td><td></td><td>73</td><td></td><td></td><td>32</td><td></td><td>30</td><td></td><td></td><td>27</td><td></td><td></td><td></td><td></td><td></td><td></td><td></td><td>25</td><td>24</td><td></td><td>21</td><td>20</td><td>19</td><td>18</td><td>17</td></tr> <tr><td></td><td></td><td></td><td></td><td></td><td>15</td><td></td><td>13</td><td></td><td></td><td></td><td></td><td></td><td></td><td></td><td></td><td></td><td></td><td>9</td><td>8</td><td></td><td>6</td><td>5</td><td></td><td>3</td><td>1</td></tr> </table>			70			67	66	65											58	57	55					49			47			44	43	42	41							39		37					73			32		30			27								25	24		21	20	19	18	17						15		13											9	8		6	5		3	1					
		70			67	66	65											58	57	55																																																																																																				
		49			47			44	43	42	41							39		37																																																																																																				
		73			32		30			27								25	24		21	20	19	18	17																																																																																															
					15		13											9	8		6	5		3	1																																																																																															
										AVAILABLE	NOT APPLICABLE	34566-2213	G	9	H	ST GRY	<table border="1"> <tr><td></td><td>79</td><td>78</td><td>77</td><td>76</td><td>75</td><td>74</td><td>73</td><td>72</td><td>71</td><td>70</td><td>69</td><td>68</td><td></td><td></td><td></td><td></td><td>66</td><td>65</td><td>64</td><td>63</td><td></td><td>61</td></tr> <tr><td>60</td><td>59</td><td>58</td><td>57</td><td>56</td><td></td><td></td><td>53</td><td></td><td></td><td>50</td><td></td><td></td><td></td><td></td><td></td><td></td><td></td><td></td><td></td><td>44</td><td>43</td><td></td><td>41</td></tr> <tr><td>40</td><td>39</td><td>38</td><td>37</td><td></td><td>35</td><td>34</td><td>33</td><td>32</td><td></td><td>30</td><td>29</td><td></td><td></td><td></td><td></td><td></td><td>27</td><td>26</td><td></td><td>24</td><td>23</td><td></td><td>22</td><td>21</td></tr> <tr><td>20</td><td>19</td><td>18</td><td>17</td><td></td><td></td><td>14</td><td>13</td><td>12</td><td>11</td><td>10</td><td>9</td><td>8</td><td></td><td></td><td></td><td></td><td>6</td><td>5</td><td></td><td></td><td></td><td>3</td><td>2</td><td>1</td></tr> </table>		79	78	77	76	75	74	73	72	71	70	69	68					66	65	64	63		61	60	59	58	57	56			53			50										44	43		41	40	39	38	37		35	34	33	32		30	29						27	26		24	23		22	21	20	19	18	17			14	13	12	11	10	9	8					6	5				3	2	1						
	79	78	77	76	75	74	73	72	71	70	69	68					66	65	64	63		61																																																																																																		
60	59	58	57	56			53			50										44	43		41																																																																																																	
40	39	38	37		35	34	33	32		30	29						27	26		24	23		22	21																																																																																																
20	19	18	17			14	13	12	11	10	9	8					6	5				3	2	1																																																																																																
										AVAILABLE	NOT APPLICABLE	34566-2223	G	0	A	BLACK	<table border="1"> <tr><td>72</td><td>71</td><td>70</td><td>69</td><td>68</td><td>67</td><td>66</td><td></td><td>64</td><td>63</td><td>62</td><td></td><td>60</td><td>59</td><td></td><td></td><td></td><td></td><td></td><td></td><td>55</td><td>54</td><td>53</td></tr> <tr><td>52</td><td></td><td></td><td>49</td><td>48</td><td>46</td><td></td><td></td><td>44</td><td>43</td><td>42</td><td></td><td>40</td><td>39</td><td></td><td></td><td></td><td></td><td></td><td></td><td></td><td>35</td><td>34</td><td>33</td></tr> <tr><td></td><td></td><td></td><td>73</td><td></td><td></td><td></td><td></td><td></td><td></td><td>29</td><td></td><td></td><td></td><td></td><td></td><td></td><td></td><td>24</td><td>23</td><td></td><td></td><td></td><td>19</td><td>18</td><td>17</td></tr> <tr><td></td><td></td><td></td><td></td><td>16</td><td></td><td></td><td></td><td>14</td><td>13</td><td>12</td><td>11</td><td></td><td>9</td><td>8</td><td>7</td><td>6</td><td>5</td><td></td><td></td><td></td><td>4</td><td>3</td><td>2</td><td>1</td></tr> </table>	72	71	70	69	68	67	66		64	63	62		60	59							55	54	53	52			49	48	46			44	43	42		40	39								35	34	33				73							29								24	23				19	18	17					16				14	13	12	11		9	8	7	6	5				4	3	2	1					
72	71	70	69	68	67	66		64	63	62		60	59							55	54	53																																																																																																		
52			49	48	46			44	43	42		40	39								35	34	33																																																																																																	
			73							29								24	23				19	18	17																																																																																															
				16				14	13	12	11		9	8	7	6	5				4	3	2	1																																																																																																
										AVAILABLE	NOT APPLICABLE	34566-2233	G	0	A	BLACK	<table border="1"> <tr><td></td><td></td><td></td><td>69</td><td></td><td></td><td></td><td></td><td></td><td></td><td>63</td><td></td><td></td><td></td><td></td><td></td><td></td><td></td><td>58</td><td></td><td>56</td><td></td><td>54</td></tr> <tr><td>52</td><td>51</td><td></td><td>49</td><td></td><td></td><td></td><td></td><td>44</td><td>43</td><td>42</td><td>41</td><td></td><td></td><td></td><td></td><td></td><td></td><td></td><td></td><td>36</td><td>35</td><td>34</td><td>33</td></tr> <tr><td></td><td></td><td></td><td>73</td><td></td><td></td><td></td><td></td><td></td><td></td><td>28</td><td>26</td><td></td><td></td><td></td><td></td><td></td><td></td><td></td><td></td><td></td><td></td><td></td><td>19</td><td>18</td></tr> <tr><td></td><td></td><td></td><td></td><td>16</td><td></td><td></td><td></td><td></td><td></td><td>12</td><td>10</td><td></td><td></td><td></td><td></td><td></td><td></td><td></td><td></td><td></td><td></td><td></td><td>3</td><td></td></tr> </table>				69							63								58		56		54	52	51		49					44	43	42	41									36	35	34	33				73							28	26												19	18					16						12	10												3							
			69							63								58		56		54																																																																																																		
52	51		49					44	43	42	41									36	35	34	33																																																																																																	
			73							28	26												19	18																																																																																																
				16						12	10												3																																																																																																	
										AVAILABLE	NOT APPLICABLE	34566-2243	G	0	H	ST GRY	<table border="1"> <tr><td></td><td>79</td><td>78</td><td>77</td><td>76</td><td>75</td><td>74</td><td>73</td><td>72</td><td>71</td><td>70</td><td>69</td><td>68</td><td></td><td></td><td></td><td></td><td>66</td><td>65</td><td>64</td><td>63</td><td></td><td>61</td></tr> <tr><td>60</td><td>59</td><td>58</td><td>57</td><td>56</td><td></td><td></td><td>53</td><td>52</td><td></td><td>50</td><td></td><td></td><td></td><td></td><td></td><td></td><td></td><td></td><td></td><td>44</td><td>43</td><td></td><td>41</td></tr> <tr><td>40</td><td>39</td><td>38</td><td>37</td><td></td><td>35</td><td>34</td><td>33</td><td>32</td><td></td><td>30</td><td>29</td><td></td><td></td><td></td><td></td><td></td><td>27</td><td>26</td><td></td><td>24</td><td>23</td><td></td><td>22</td><td>21</td></tr> <tr><td>20</td><td>19</td><td>18</td><td>17</td><td></td><td>16</td><td></td><td>14</td><td>13</td><td>12</td><td>11</td><td>10</td><td>9</td><td>8</td><td></td><td></td><td></td><td>6</td><td>5</td><td></td><td></td><td></td><td>3</td><td>2</td><td>1</td></tr> </table>		79	78	77	76	75	74	73	72	71	70	69	68					66	65	64	63		61	60	59	58	57	56			53	52		50										44	43		41	40	39	38	37		35	34	33	32		30	29						27	26		24	23		22	21	20	19	18	17		16		14	13	12	11	10	9	8				6	5				3	2	1						
	79	78	77	76	75	74	73	72	71	70	69	68					66	65	64	63		61																																																																																																		
60	59	58	57	56			53	52		50										44	43		41																																																																																																	
40	39	38	37		35	34	33	32		30	29						27	26		24	23		22	21																																																																																																
20	19	18	17		16		14	13	12	11	10	9	8				6	5				3	2	1																																																																																																
										AVAILABLE	NOT APPLICABLE	34566-2253	G	0	A	BLACK	<table border="1"> <tr><td>72</td><td>71</td><td>70</td><td>69</td><td>68</td><td>67</td><td>66</td><td></td><td>65</td><td>64</td><td>63</td><td></td><td>61</td><td></td><td>59</td><td>58</td><td></td><td></td><td></td><td>56</td><td></td><td>54</td><td>53</td></tr> <tr><td>52</td><td></td><td></td><td>50</td><td>49</td><td></td><td>47</td><td></td><td></td><td></td><td>42</td><td>41</td><td></td><td></td><td></td><td></td><td></td><td></td><td></td><td></td><td>38</td><td>37</td><td>36</td><td>34</td><td>33</td></tr> <tr><td></td><td></td><td></td><td>73</td><td></td><td></td><td></td><td></td><td>32</td><td>31</td><td>30</td><td>29</td><td>28</td><td>27</td><td>26</td><td></td><td></td><td>24</td><td>23</td><td></td><td>22</td><td>21</td><td>20</td><td>19</td><td>18</td><td>17</td></tr> <tr><td></td><td></td><td></td><td></td><td>16</td><td></td><td></td><td></td><td></td><td></td><td>13</td><td>12</td><td>11</td><td>10</td><td>9</td><td>8</td><td></td><td></td><td></td><td></td><td></td><td></td><td></td><td></td><td></td><td>1</td></tr> </table>	72	71	70	69	68	67	66		65	64	63		61		59	58				56		54	53	52			50	49		47				42	41									38	37	36	34	33				73					32	31	30	29	28	27	26			24	23		22	21	20	19	18	17					16						13	12	11	10	9	8										1			
72	71	70	69	68	67	66		65	64	63		61		59	58				56		54	53																																																																																																		
52			50	49		47				42	41									38	37	36	34	33																																																																																																
			73					32	31	30	29	28	27	26			24	23		22	21	20	19	18	17																																																																																															
				16						13	12	11	10	9	8										1																																																																																															
										AVAILABLE	NOT APPLICABLE	34566-2263	G	0	A	BLACK	<table border="1"> <tr><td></td><td></td><td></td><td>69</td><td></td><td></td><td></td><td></td><td></td><td></td><td>63</td><td></td><td></td><td></td><td></td><td></td><td></td><td></td><td></td><td>58</td><td></td><td>56</td><td>55</td><td>54</td><td>53</td></tr> <tr><td>52</td><td>51</td><td>50</td><td>49</td><td></td><td></td><td></td><td></td><td>44</td><td>43</td><td>42</td><td>41</td><td></td><td></td><td></td><td></td><td></td><td></td><td></td><td></td><td></td><td>36</td><td>35</td><td>34</td><td>33</td></tr> <tr><td></td><td></td><td></td><td>73</td><td></td><td></td><td></td><td></td><td></td><td></td><td>28</td><td>26</td><td></td><td></td><td></td><td></td><td></td><td></td><td></td><td></td><td></td><td></td><td></td><td></td><td>19</td><td>18</td></tr> <tr><td></td><td></td><td></td><td></td><td>16</td><td></td><td></td><td></td><td></td><td></td><td>14</td><td>12</td><td>10</td><td></td><td></td><td></td><td></td><td></td><td></td><td></td><td></td><td></td><td></td><td></td><td>3</td><td></td></tr> </table>				69							63									58		56	55	54	53	52	51	50	49					44	43	42	41										36	35	34	33				73							28	26													19	18					16						14	12	10												3		
			69							63									58		56	55	54	53																																																																																																
52	51	50	49					44	43	42	41										36	35	34	33																																																																																																
			73							28	26													19	18																																																																																															
				16						14	12	10												3																																																																																																
										AVAILABLE	NOT APPLICABLE	34566-2273	G	0	A	BLACK	<table border="1"> <tr><td></td><td></td><td></td><td>69</td><td></td><td></td><td></td><td></td><td></td><td></td><td>63</td><td>62</td><td>61</td><td></td><td></td><td></td><td></td><td></td><td>58</td><td>57</td><td>56</td><td>55</td><td>54</td><td>53</td></tr> <tr><td>52</td><td>51</td><td>50</td><td>49</td><td></td><td></td><td></td><td></td><td>44</td><td>43</td><td>42</td><td>41</td><td></td><td></td><td></td><td></td><td></td><td></td><td></td><td></td><td>37</td><td>36</td><td>35</td><td>34</td><td>33</td></tr> <tr><td></td><td></td><td></td><td>73</td><td></td><td></td><td></td><td></td><td></td><td></td><td>29</td><td>28</td><td>27</td><td>26</td><td></td><td></td><td></td><td></td><td></td><td></td><td></td><td></td><td></td><td></td><td>19</td><td>18</td></tr> <tr><td></td><td></td><td></td><td></td><td>16</td><td></td><td></td><td></td><td></td><td></td><td>14</td><td>13</td><td>12</td><td>11</td><td>10</td><td></td><td></td><td></td><td></td><td></td><td></td><td></td><td></td><td></td><td>3</td><td></td></tr> </table>				69							63	62	61						58	57	56	55	54	53	52	51	50	49					44	43	42	41									37	36	35	34	33				73							29	28	27	26											19	18					16						14	13	12	11	10										3			
			69							63	62	61						58	57	56	55	54	53																																																																																																	
52	51	50	49					44	43	42	41									37	36	35	34	33																																																																																																
			73							29	28	27	26											19	18																																																																																															
				16						14	13	12	11	10										3																																																																																																
										AVAILABLE	NOT APPLICABLE	34566-2283	G	0	B	ST. GRY	<table border="1"> <tr><td></td><td></td><td></td><td></td><td>68</td><td>67</td><td>66</td><td>65</td><td>64</td><td>63</td><td></td><td></td><td></td><td></td><td></td><td></td><td></td><td></td><td></td><td></td><td></td><td></td><td></td><td>55</td><td></td></tr> <tr><td></td><td></td><td></td><td></td><td>49</td><td>48</td><td>46</td><td>45</td><td>44</td><td>43</td><td></td><td></td><td></td><td></td><td></td><td></td><td></td><td></td><td></td><td></td><td></td><td></td><td></td><td></td><td></td><td></td></tr> <tr><td></td><td></td><td></td><td></td><td>73</td><td></td><td></td><td></td><td>30</td><td>29</td><td>28</td><td>27</td><td></td><td></td><td></td><td></td><td></td><td></td><td></td><td></td><td></td><td></td><td></td><td></td><td></td><td>17</td></tr> <tr><td></td><td></td><td></td><td></td><td></td><td>16</td><td></td><td></td><td></td><td></td><td></td><td></td><td>10</td><td></td><td></td><td></td><td></td><td></td><td></td><td></td><td></td><td></td><td></td><td></td><td></td><td></td></tr> </table>					68	67	66	65	64	63														55						49	48	46	45	44	43																					73				30	29	28	27														17						16							10													
				68	67	66	65	64	63														55																																																																																																	
				49	48	46	45	44	43																																																																																																															
				73				30	29	28	27														17																																																																																															
					16							10																																																																																																												

ENTER DESCRIPTION IEC NO: UAU2010-1551 DRAWN BY: SRAJENDRANAT CHKD BY: TSK I VER APPR: VKOSHY DATE: 2010/03/15 DATE: 2008/05/09 DATE: 2008/05/09 DATE: 2010/03/18	QUALITY SYMBOLS $\nabla=0$ $\nabla=0$	GENERAL TOLERANCES (UNLESS SPECIFIED) <table border="1"> <tr><th></th><th>mm</th><th>INCH</th></tr> <tr><td>4 PLACES</td><td>± .005</td><td>± .0004</td></tr> <tr><td>3 PLACES</td><td>± .005</td><td>± .0004</td></tr> <tr><td>2 PLACES</td><td>± .005</td><td>± .0004</td></tr> <tr><td>1 PLACE</td><td>± .005</td><td>± .0004</td></tr> <tr><td>ANGULAR</td><td>± .005°</td><td></td></tr> </table>		mm	INCH	4 PLACES	± .005	± .0004	3 PLACES	± .005	± .0004	2 PLACES	± .005	± .0004	1 PLACE	± .005	± .0004	ANGULAR	± .005°		DIMENSION STYLE MM ONLY	SCALE 1:1	DESIGN UNITS METRIC	THIRD ANGLE PROJECTION
		mm	INCH																					
	4 PLACES	± .005	± .0004																					
	3 PLACES	± .005	± .0004																					
2 PLACES	± .005	± .0004																						
1 PLACE	± .005	± .0004																						
ANGULAR	± .005°																							
DESCRIPTION F40	DRAWN BY SRAJENDRANAT	DATE 2008/05/09	TITLE MX123 73/80 CKT HRNS CONN ASSY	MOLEX INCORPORATED	DOCUMENT NO. SD-34566-001	SHEET NO. 27 OF 36																		
DRAFT WHERE APPLICABLE MUST REMAIN WITHIN DIMENSIONS	SEE BOM TABLE	THIS DRAWING CONTAINS INFORMATION THAT IS PROPRIETARY TO MOLEX INCORPORATED AND SHOULD NOT BE USED WITHOUT WRITTEN PERMISSION																						

20	19	18	17	16	15	14	13	12	11	10	9	8	7	6	5	4	3	2	1							
										STATUS	GM PART #	MATERIAL #	PART / MATERIAL REVISION	WIRE DRESS OPTION	KEY OPTION	COLOR (TPA)	NUMBERS INDICATE CAVITIES OPEN FOR CIRCUITS									
										AVAILABLE	NOT APPLICABLE	34566-2293	G	0	C	BLUE	72 70 68 66 63 59 57 53 52 51 48 47 46 44 42 40 39 34 33 73 30 26 25 22 21 20 19 18 17 15 14 13 12 11 10 9 8 7 6 5 4 3 2 1									
										AVAILABLE	NOT APPLICABLE	34566-2319	G	0	C	BLUE	72 70 68 66 63 59 57 53 52 51 48 47 46 44 42 40 39 34 33 73 30 26 25 22 21 20 19 18 17 15 14 13 12 11 10 9 8 7 6 5 4 3 2 1									
										AVAILABLE	NOT APPLICABLE	34566-2323	G	0	C	BLUE	72 70 68 66 63 59 57 53 52 51 48 47 46 44 42 40 39 34 33 73 30 26 25 22 21 20 19 18 17 15 14 13 12 11 10 9 8 7 6 5 4 3 2 1									
										AVAILABLE	NOT APPLICABLE	34566-2333	G	0	A	BLACK	71 69 68 65 64 63 61 59 57 56 55 54 53 52 50 49 47 46 45 44 43 42 41 39 38 37 36 35 34 33 73 32 31 30 29 28 27 26 25 24 23 22 21 20 19 18 17 16 15 14 13 12 11 10 9 8 7 6 5 4 3 2 1									
										AVAILABLE	NOT APPLICABLE	34566-2343	G	0	A	BLACK	72 70 68 67 66 65 64 63 62 61 59 57 55 54 53 52 51 49 47 46 45 44 43 42 41 39 37 35 34 33 73 32 30 27 25 24 23 22 21 20 19 18 17 15 14 13 12 11 10 9 8 7 6 5 4 3 2 1									
										AVAILABLE	NOT APPLICABLE	34566-2353	G	0	A	BLACK	72 70 67 66 65 64 63 62 61 59 57 55 54 53 52 51 49 47 46 45 44 43 42 41 39 37 35 34 33 73 32 30 27 25 24 23 22 21 20 19 18 17 15 14 13 12 11 10 9 8 7 6 5 4 3 2 1									
										AVAILABLE	NOT APPLICABLE	34566-2363	G	0	C	BLUE	72 70 67 66 63 62 59 57 53 52 51 48 47 46 44 42 40 39 38 34 33 73 32 30 27 26 25 24 23 22 21 20 19 18 17 15 14 13 12 11 10 9 8 7 6 5 4 3 2 1									
										AVAILABLE	NOT APPLICABLE	34566-2373	G	0	B	ST GRAY	68 67 66 65 64 61 60 59 58 57 55 54 53 51 50 49 48 47 46 45 43 42 41 40 39 38 37 35 34 33 73 32 31 30 26 24 23 22 21 20 19 18 17 16 15 14 13 12 11 10 9 8 7 6 5 4 3 2 1									
										AVAILABLE	NOT APPLICABLE	34566-2383	G	0	B	ST GRAY	65 59 57 55 53 50 49 48 46 44 43 42 41 40 39 38 37 35 34 33 73 15 29 24 23 21 20 19 18 17 6 5 4 3 2 1									

ENTER DESCRIPTION EC NO: UAU2010-151 DRAWN BY: SRAJENDRANAT CHECKED BY: TSK IVER APPROVED BY: VKOSHY DATE: 2010/03/18 SHEET NO: 28 OF 36	QUALITY SYMBOLS ◻=0 ◻=1 ◻=2 ◻=3 ◻=4 ◻=5 ◻=6 ◻=7 ◻=8 ◻=9 ◻=10 ◻=11 ◻=12 ◻=13 ◻=14 ◻=15 ◻=16 ◻=17 ◻=18 ◻=19 ◻=20	GENERAL TOLERANCES (UNLESS SPECIFIED) DIMENSION STYLE: MM ONLY SCALE: 1:1 DESIGN UNITS: METRIC THIRD ANGLE PROJECTION	DRAWN BY: SRAJENDRANAT CHECKED BY: TSK IVER APPROVED BY: VKOSHY DATE: 2010/03/18 MATERIAL NO.: DOCUMENT NO.: SHEET NO.: 28 OF 36	
	4 PLACES ±---+ 3 PLACES ±---+ 2 PLACES ±---+ 1 PLACE ±---+ ANGULAR ±---0	min INCH ±---+ ±---+ ±---+ ±---+ ±---0	TITLE: MX123 73/80 CKT HRNS CONN ASSY MOLEX INCORPORATED	SEE BOM TABLE THIS DRAWING CONTAINS INFORMATION THAT IS PROPRIETARY TO MOLEX INCORPORATED AND SHOULD NOT BE USED WITHOUT WRITTEN PERMISSION
	DRAFT WHERE APPLICABLE MUST REMAIN WITHIN DIMENSIONS		DRAFT WHERE APPLICABLE MUST REMAIN WITHIN DIMENSIONS	
	F40		D	

STATUS	GM PART #	MATERIAL #	PART / MATERIAL REVISION	WIRE DRESS OPTION	KEY OPTION	COLOR (TPA)	NUMBERS INDICATE CAVITIES OPEN FOR CIRCUITS																																																																															
AVAILABLE	NOT APPLICABLE	34566-2483	G	0	A	BLACK	<table border="1"> <tr><td></td><td></td><td>69</td><td></td><td></td><td></td><td>63</td><td>62</td><td>61</td><td></td><td>58</td><td>57</td><td>56</td><td>55</td><td>54</td><td>53</td></tr> <tr><td>52</td><td>51</td><td>49</td><td></td><td></td><td></td><td>44</td><td>43</td><td>42</td><td>41</td><td></td><td>37</td><td>36</td><td>35</td><td>34</td><td>33</td></tr> <tr><td colspan="2">73</td><td>32</td><td></td><td>29</td><td>28</td><td>27</td><td>26</td><td></td><td>23</td><td></td><td></td><td></td><td>19</td><td>18</td><td></td></tr> <tr><td colspan="2"></td><td>16</td><td></td><td>13</td><td>12</td><td>11</td><td>10</td><td></td><td>8</td><td></td><td></td><td></td><td>3</td><td></td><td></td></tr> </table>			69				63	62	61		58	57	56	55	54	53	52	51	49				44	43	42	41		37	36	35	34	33	73		32		29	28	27	26		23				19	18				16		13	12	11	10		8				3																	
		69				63	62	61		58	57	56	55	54	53																																																																							
52	51	49				44	43	42	41		37	36	35	34	33																																																																							
73		32		29	28	27	26		23				19	18																																																																								
		16		13	12	11	10		8				3																																																																									
AVAILABLE	NOT APPLICABLE	34566-2493	G	0	B	ST GRAY	<table border="1"> <tr><td>72</td><td>71</td><td>70</td><td>68</td><td>67</td><td>66</td><td></td><td></td><td>62</td><td>61</td><td>60</td><td>59</td><td>58</td><td>57</td><td>56</td><td>55</td><td>54</td><td>53</td></tr> <tr><td>52</td><td>51</td><td>50</td><td>48</td><td>47</td><td>46</td><td></td><td></td><td>42</td><td>41</td><td>40</td><td>39</td><td>38</td><td>37</td><td>36</td><td>35</td><td>34</td><td>33</td></tr> <tr><td colspan="2">73</td><td>32</td><td>31</td><td>30</td><td>29</td><td>28</td><td>27</td><td>26</td><td>25</td><td>24</td><td></td><td></td><td></td><td></td><td></td><td></td><td>17</td></tr> <tr><td colspan="2"></td><td>16</td><td>15</td><td>14</td><td>13</td><td></td><td></td><td>10</td><td>8</td><td></td><td></td><td></td><td></td><td></td><td></td><td>2</td><td>1</td></tr> </table>	72	71	70	68	67	66			62	61	60	59	58	57	56	55	54	53	52	51	50	48	47	46			42	41	40	39	38	37	36	35	34	33	73		32	31	30	29	28	27	26	25	24							17			16	15	14	13			10	8							2	1							
72	71	70	68	67	66			62	61	60	59	58	57	56	55	54	53																																																																					
52	51	50	48	47	46			42	41	40	39	38	37	36	35	34	33																																																																					
73		32	31	30	29	28	27	26	25	24							17																																																																					
		16	15	14	13			10	8							2	1																																																																					
AVAILABLE	NOT APPLICABLE	34566-2513	G	0	C	BLUE	<table border="1"> <tr><td>72</td><td>71</td><td>70</td><td>68</td><td>67</td><td>66</td><td></td><td></td><td>63</td><td>62</td><td></td><td>59</td><td>57</td><td></td><td></td><td></td><td></td><td>53</td></tr> <tr><td>52</td><td>51</td><td></td><td>48</td><td>47</td><td>46</td><td></td><td>44</td><td>42</td><td>41</td><td>40</td><td>39</td><td></td><td></td><td></td><td></td><td></td><td>34</td><td>33</td></tr> <tr><td colspan="2">73</td><td>32</td><td></td><td>30</td><td></td><td></td><td>27</td><td>26</td><td>25</td><td>24</td><td></td><td>22</td><td>21</td><td>20</td><td></td><td></td><td></td><td></td></tr> <tr><td colspan="2"></td><td></td><td>15</td><td>14</td><td></td><td></td><td></td><td>10</td><td>9</td><td></td><td>6</td><td>5</td><td>4</td><td></td><td></td><td></td><td></td><td></td></tr> </table>	72	71	70	68	67	66			63	62		59	57					53	52	51		48	47	46		44	42	41	40	39						34	33	73		32		30			27	26	25	24		22	21	20								15	14				10	9		6	5	4									
72	71	70	68	67	66			63	62		59	57					53																																																																					
52	51		48	47	46		44	42	41	40	39						34	33																																																																				
73		32		30			27	26	25	24		22	21	20																																																																								
			15	14				10	9		6	5	4																																																																									
AVAILABLE	NOT APPLICABLE	34566-2523	G	0	A	BLACK	<table border="1"> <tr><td>72</td><td>71</td><td>70</td><td>69</td><td>68</td><td>67</td><td>66</td><td>65</td><td>64</td><td>63</td><td>62</td><td>61</td><td>60</td><td>59</td><td></td><td></td><td>55</td><td>54</td><td>53</td></tr> <tr><td>52</td><td></td><td>49</td><td>48</td><td></td><td>45</td><td>44</td><td>43</td><td>42</td><td>41</td><td>40</td><td>39</td><td></td><td></td><td></td><td></td><td>35</td><td>34</td><td>33</td></tr> <tr><td colspan="2">73</td><td>32</td><td></td><td>29</td><td>28</td><td>27</td><td></td><td>25</td><td>24</td><td>23</td><td></td><td></td><td></td><td></td><td></td><td>19</td><td>18</td><td>17</td></tr> <tr><td colspan="2"></td><td>16</td><td></td><td>13</td><td>12</td><td>11</td><td></td><td>9</td><td>8</td><td>7</td><td>6</td><td>5</td><td>4</td><td>3</td><td>2</td><td>1</td><td></td><td></td></tr> </table>	72	71	70	69	68	67	66	65	64	63	62	61	60	59			55	54	53	52		49	48		45	44	43	42	41	40	39					35	34	33	73		32		29	28	27		25	24	23						19	18	17			16		13	12	11		9	8	7	6	5	4	3	2	1					
72	71	70	69	68	67	66	65	64	63	62	61	60	59			55	54	53																																																																				
52		49	48		45	44	43	42	41	40	39					35	34	33																																																																				
73		32		29	28	27		25	24	23						19	18	17																																																																				
		16		13	12	11		9	8	7	6	5	4	3	2	1																																																																						
AVAILABLE	NOT APPLICABLE	34566-2533	G	0	B	ST GRAY	<table border="1"> <tr><td></td><td></td><td></td><td>67</td><td>66</td><td>65</td><td>63</td><td></td><td></td><td></td><td>59</td><td>58</td><td>57</td><td>56</td><td>55</td><td></td><td></td><td></td><td>53</td></tr> <tr><td></td><td></td><td>50</td><td>49</td><td>48</td><td>46</td><td>45</td><td>43</td><td></td><td></td><td>39</td><td>38</td><td>37</td><td>36</td><td>35</td><td>34</td><td></td><td></td><td>33</td></tr> <tr><td colspan="2">73</td><td></td><td></td><td>29</td><td></td><td>27</td><td></td><td></td><td></td><td>23</td><td>22</td><td>21</td><td></td><td></td><td></td><td></td><td></td><td>18</td></tr> <tr><td colspan="2"></td><td></td><td>16</td><td>15</td><td>14</td><td>13</td><td></td><td></td><td></td><td>8</td><td>7</td><td>6</td><td>5</td><td>4</td><td>3</td><td></td><td></td><td></td></tr> </table>				67	66	65	63				59	58	57	56	55				53			50	49	48	46	45	43			39	38	37	36	35	34			33	73				29		27				23	22	21						18				16	15	14	13				8	7	6	5	4	3						
			67	66	65	63				59	58	57	56	55				53																																																																				
		50	49	48	46	45	43			39	38	37	36	35	34			33																																																																				
73				29		27				23	22	21						18																																																																				
			16	15	14	13				8	7	6	5	4	3																																																																							
AVAILABLE	NOT APPLICABLE	34566-2543	G	0	C	BLUE	<table border="1"> <tr><td>72</td><td>71</td><td>70</td><td></td><td></td><td>66</td><td></td><td></td><td>63</td><td></td><td></td><td>59</td><td>57</td><td></td><td></td><td></td><td></td><td></td><td>53</td></tr> <tr><td>52</td><td>51</td><td></td><td></td><td></td><td>46</td><td></td><td>44</td><td>42</td><td>41</td><td>40</td><td>39</td><td></td><td></td><td></td><td></td><td></td><td></td><td>34</td><td>33</td></tr> <tr><td colspan="2">73</td><td>32</td><td></td><td>30</td><td></td><td></td><td>27</td><td>26</td><td>25</td><td></td><td></td><td>22</td><td>21</td><td></td><td></td><td></td><td></td><td></td><td></td></tr> <tr><td colspan="2"></td><td></td><td>15</td><td>14</td><td></td><td></td><td></td><td>10</td><td>9</td><td></td><td>6</td><td></td><td></td><td></td><td></td><td></td><td></td><td></td><td></td></tr> </table>	72	71	70			66			63			59	57						53	52	51				46		44	42	41	40	39							34	33	73		32		30			27	26	25			22	21										15	14				10	9		6								
72	71	70			66			63			59	57						53																																																																				
52	51				46		44	42	41	40	39							34	33																																																																			
73		32		30			27	26	25			22	21																																																																									
			15	14				10	9		6																																																																											
AVAILABLE	NOT APPLICABLE	34566-2553	G	9	B	ST GRAY	<table border="1"> <tr><td>72</td><td>71</td><td>70</td><td>68</td><td>67</td><td>66</td><td></td><td></td><td>62</td><td>61</td><td>60</td><td>59</td><td>58</td><td>57</td><td>56</td><td>55</td><td>54</td><td>53</td></tr> <tr><td>52</td><td>51</td><td>50</td><td>48</td><td>47</td><td>46</td><td></td><td></td><td>42</td><td>41</td><td>40</td><td>39</td><td>38</td><td>37</td><td>36</td><td>35</td><td>34</td><td>33</td></tr> <tr><td colspan="2">73</td><td>32</td><td>31</td><td>30</td><td>29</td><td>28</td><td>27</td><td>26</td><td>25</td><td>24</td><td>23</td><td></td><td></td><td></td><td></td><td></td><td></td><td></td></tr> <tr><td colspan="2"></td><td>16</td><td>15</td><td>14</td><td>13</td><td></td><td></td><td>10</td><td>9</td><td>8</td><td></td><td></td><td></td><td></td><td></td><td></td><td></td><td></td></tr> </table>	72	71	70	68	67	66			62	61	60	59	58	57	56	55	54	53	52	51	50	48	47	46			42	41	40	39	38	37	36	35	34	33	73		32	31	30	29	28	27	26	25	24	23										16	15	14	13			10	9	8													
72	71	70	68	67	66			62	61	60	59	58	57	56	55	54	53																																																																					
52	51	50	48	47	46			42	41	40	39	38	37	36	35	34	33																																																																					
73		32	31	30	29	28	27	26	25	24	23																																																																											
		16	15	14	13			10	9	8																																																																												
AVAILABLE	NOT APPLICABLE	34566-2563	G	9	A	BLACK	<table border="1"> <tr><td></td><td></td><td>69</td><td></td><td></td><td></td><td></td><td></td><td>63</td><td>62</td><td>61</td><td></td><td>58</td><td>57</td><td>56</td><td>55</td><td>54</td><td>53</td></tr> <tr><td>52</td><td>51</td><td>50</td><td>49</td><td></td><td></td><td></td><td></td><td>44</td><td>43</td><td>42</td><td>41</td><td></td><td>37</td><td>36</td><td>35</td><td>34</td><td>33</td></tr> <tr><td colspan="2">73</td><td>32</td><td></td><td>29</td><td>28</td><td>27</td><td>26</td><td></td><td></td><td></td><td></td><td></td><td></td><td>19</td><td>18</td><td></td><td></td></tr> <tr><td colspan="2"></td><td>16</td><td></td><td>14</td><td>13</td><td>12</td><td>11</td><td>10</td><td></td><td></td><td></td><td></td><td></td><td>3</td><td></td><td></td><td></td></tr> </table>			69						63	62	61		58	57	56	55	54	53	52	51	50	49					44	43	42	41		37	36	35	34	33	73		32		29	28	27	26							19	18					16		14	13	12	11	10						3										
		69						63	62	61		58	57	56	55	54	53																																																																					
52	51	50	49					44	43	42	41		37	36	35	34	33																																																																					
73		32		29	28	27	26							19	18																																																																							
		16		14	13	12	11	10						3																																																																								
AVAILABLE	NOT APPLICABLE	34566-2573	G	9	C	BLUE	<table border="1"> <tr><td>72</td><td>71</td><td>70</td><td></td><td></td><td>67</td><td>66</td><td></td><td>63</td><td>62</td><td></td><td>59</td><td>57</td><td></td><td></td><td></td><td></td><td></td><td>53</td></tr> <tr><td>52</td><td>51</td><td></td><td></td><td></td><td>46</td><td>44</td><td></td><td>42</td><td>41</td><td>40</td><td>39</td><td></td><td></td><td></td><td></td><td></td><td></td><td>34</td><td>33</td></tr> <tr><td colspan="2">73</td><td></td><td></td><td>30</td><td></td><td></td><td></td><td>26</td><td>25</td><td></td><td></td><td>22</td><td>21</td><td>20</td><td></td><td></td><td></td><td></td><td></td></tr> <tr><td colspan="2"></td><td></td><td>15</td><td>14</td><td></td><td></td><td></td><td>10</td><td>9</td><td></td><td>6</td><td>5</td><td>4</td><td></td><td></td><td></td><td></td><td></td><td></td></tr> </table>	72	71	70			67	66		63	62		59	57						53	52	51				46	44		42	41	40	39							34	33	73				30				26	25			22	21	20									15	14				10	9		6	5	4						
72	71	70			67	66		63	62		59	57						53																																																																				
52	51				46	44		42	41	40	39							34	33																																																																			
73				30				26	25			22	21	20																																																																								
			15	14				10	9		6	5	4																																																																									

ENTER DESCRIPTION TEC NO. JAU2010-1551 DRAWN BY CHYKORFF JHS CHECKED BY APPR:VKOSHY DATE 2010/03/15 DATE 2008/05/09 DATE 2010/03/18	QUALITY SYMBOLS ▽=0 ▽=0	GENERAL TOLERANCES (UNLESS SPECIFIED) mm INCH 4 PLACES ±--- ±--- 3 PLACES ±--- ±--- 2 PLACES ±--- ±--- 1 PLACE ±--- ±--- ANGULAR ±----°	DIMENSION STYLE MM ONLY	SCALE 1:1	DESIGN UNITS METRIC	THIRD ANGLE PROJECTION 	
	DRAWN BY DATE SRAJENDRANAT 2008/05/09		CHECKED BY DATE TSK IVER 2008/05/09		APPROVED BY DATE VKOSHY 2010/03/18		MATERIAL NO. DATE MOLEX INCORPORATED
	DRAFT WHERE APPLICABLE MUST REMAIN WITHIN DIMENSIONS		SEE BOM TABLE		DOCUMENT NO. SHEET NO. SD-34566-001 30 OF 36		TITLE MX123 73/80 CKT HRNS CONN ASSY
	THIS DRAWING CONTAINS INFORMATION THAT IS PROPRIETARY TO MOLEX INCORPORATED AND SHOULD NOT BE USED WITHOUT WRITTEN PERMISSION						

STATUS	GM PART #	MATERIAL #	PART/MATERIAL REVISION	WIRE DRESS OPTION	KEY OPTION	COLOR (TPA)	NUMBERS INDICATE CAVITIES OPEN FOR CIRCUITS																																																																														
AVAILABLE	NOT APPLICABLE	34566-2583	G	0	A	BLACK	<table border="1"> <tr><td></td><td></td><td>69</td><td></td><td></td><td></td><td>63</td><td></td><td></td><td>58</td><td>56</td><td>55</td><td>54</td><td>53</td></tr> <tr><td>52</td><td>51</td><td>50</td><td>49</td><td></td><td></td><td>44</td><td>43</td><td>42</td><td>41</td><td>39</td><td></td><td>36</td><td>35</td><td>34</td><td>33</td></tr> <tr><td></td><td></td><td>73</td><td>32</td><td></td><td></td><td>28</td><td>26</td><td></td><td></td><td></td><td></td><td>19</td><td>18</td><td></td><td></td></tr> <tr><td></td><td></td><td></td><td>16</td><td></td><td>14</td><td>12</td><td>10</td><td></td><td></td><td></td><td></td><td></td><td>3</td><td></td><td></td></tr> </table>			69				63			58	56	55	54	53	52	51	50	49			44	43	42	41	39		36	35	34	33			73	32			28	26					19	18						16		14	12	10						3																		
		69				63			58	56	55	54	53																																																																								
52	51	50	49			44	43	42	41	39		36	35	34	33																																																																						
		73	32			28	26					19	18																																																																								
			16		14	12	10						3																																																																								
AVAILABLE	NOT APPLICABLE	34566-2593	G	0	C	BLUE	<table border="1"> <tr><td>72</td><td>70</td><td></td><td></td><td>66</td><td></td><td>63</td><td>62</td><td></td><td>59</td><td>57</td><td></td><td></td><td></td><td></td><td>53</td></tr> <tr><td>52</td><td>51</td><td></td><td></td><td>46</td><td>44</td><td>42</td><td>40</td><td>39</td><td></td><td></td><td></td><td></td><td></td><td>34</td><td>33</td></tr> <tr><td></td><td></td><td>73</td><td>32</td><td></td><td>30</td><td></td><td>27</td><td>26</td><td>25</td><td></td><td>22</td><td>21</td><td></td><td></td><td></td></tr> <tr><td></td><td></td><td></td><td></td><td>15</td><td>14</td><td></td><td></td><td>10</td><td>9</td><td></td><td>6</td><td></td><td></td><td></td><td></td></tr> </table>	72	70			66		63	62		59	57					53	52	51			46	44	42	40	39						34	33			73	32		30		27	26	25		22	21								15	14			10	9		6																		
72	70			66		63	62		59	57					53																																																																						
52	51			46	44	42	40	39						34	33																																																																						
		73	32		30		27	26	25		22	21																																																																									
				15	14			10	9		6																																																																										
AVAILABLE	NOT APPLICABLE	34566-2613	G	9	C	BLUE	<table border="1"> <tr><td>72</td><td>70</td><td></td><td>67</td><td>66</td><td></td><td>63</td><td>62</td><td></td><td>59</td><td>57</td><td></td><td></td><td></td><td></td><td>53</td></tr> <tr><td>52</td><td>51</td><td></td><td></td><td>46</td><td>44</td><td>42</td><td>40</td><td>39</td><td></td><td></td><td></td><td></td><td></td><td>34</td><td>33</td></tr> <tr><td></td><td></td><td>73</td><td></td><td></td><td>30</td><td></td><td>27</td><td>26</td><td>25</td><td></td><td>22</td><td>21</td><td>20</td><td></td><td></td></tr> <tr><td></td><td></td><td></td><td></td><td>15</td><td>14</td><td></td><td></td><td>10</td><td>9</td><td></td><td>6</td><td>5</td><td>4</td><td></td><td></td></tr> </table>	72	70		67	66		63	62		59	57					53	52	51			46	44	42	40	39						34	33			73			30		27	26	25		22	21	20							15	14			10	9		6	5	4																
72	70		67	66		63	62		59	57					53																																																																						
52	51			46	44	42	40	39						34	33																																																																						
		73			30		27	26	25		22	21	20																																																																								
				15	14			10	9		6	5	4																																																																								
AVAILABLE	NOT APPLICABLE	34566-2623	G	0	A	BLACK	<table border="1"> <tr><td></td><td>71</td><td>69</td><td>68</td><td>67</td><td>65</td><td>64</td><td>63</td><td></td><td>61</td><td>59</td><td>57</td><td>56</td><td></td><td></td><td></td></tr> <tr><td></td><td></td><td>50</td><td>49</td><td>47</td><td></td><td></td><td></td><td></td><td>41</td><td></td><td>38</td><td>37</td><td>36</td><td></td><td>34</td><td>33</td></tr> <tr><td></td><td></td><td></td><td>73</td><td>32</td><td>31</td><td>30</td><td>29</td><td>28</td><td>27</td><td></td><td>24</td><td>23</td><td></td><td>20</td><td>19</td><td>18</td></tr> <tr><td></td><td></td><td></td><td></td><td>16</td><td></td><td></td><td>13</td><td>12</td><td>11</td><td>10</td><td>9</td><td>7</td><td></td><td>4</td><td></td><td></td></tr> </table>		71	69	68	67	65	64	63		61	59	57	56						50	49	47					41		38	37	36		34	33				73	32	31	30	29	28	27		24	23		20	19	18					16			13	12	11	10	9	7		4													
	71	69	68	67	65	64	63		61	59	57	56																																																																									
		50	49	47					41		38	37	36		34	33																																																																					
			73	32	31	30	29	28	27		24	23		20	19	18																																																																					
				16			13	12	11	10	9	7		4																																																																							
AVAILABLE	NOT APPLICABLE	34566-2633	G	0	A	BLACK	<table border="1"> <tr><td></td><td>71</td><td>69</td><td>68</td><td>67</td><td>65</td><td>64</td><td></td><td></td><td>61</td><td>59</td><td>57</td><td>56</td><td></td><td></td><td></td><td>33</td></tr> <tr><td></td><td></td><td>50</td><td>49</td><td>47</td><td></td><td></td><td></td><td></td><td>41</td><td></td><td>38</td><td>37</td><td>36</td><td></td><td></td><td></td></tr> <tr><td></td><td></td><td></td><td>73</td><td>32</td><td>31</td><td>30</td><td>29</td><td>28</td><td>27</td><td></td><td>24</td><td>23</td><td></td><td>20</td><td>19</td><td>18</td></tr> <tr><td></td><td></td><td></td><td></td><td>16</td><td></td><td></td><td></td><td>11</td><td>10</td><td>9</td><td>7</td><td></td><td>4</td><td></td><td></td><td></td></tr> </table>		71	69	68	67	65	64			61	59	57	56				33			50	49	47					41		38	37	36							73	32	31	30	29	28	27		24	23		20	19	18					16				11	10	9	7		4													
	71	69	68	67	65	64			61	59	57	56				33																																																																					
		50	49	47					41		38	37	36																																																																								
			73	32	31	30	29	28	27		24	23		20	19	18																																																																					
				16				11	10	9	7		4																																																																								
AVAILABLE	NOT APPLICABLE	34566-2643	G	0	A	BLACK	<table border="1"> <tr><td></td><td>71</td><td>69</td><td>68</td><td>67</td><td>65</td><td>64</td><td>63</td><td></td><td>61</td><td>59</td><td>57</td><td>56</td><td></td><td></td><td></td><td></td></tr> <tr><td></td><td></td><td>50</td><td>49</td><td>47</td><td></td><td></td><td></td><td></td><td>41</td><td>39</td><td>38</td><td>37</td><td>36</td><td></td><td>34</td><td>33</td></tr> <tr><td></td><td></td><td></td><td>73</td><td>32</td><td>31</td><td>30</td><td>29</td><td>28</td><td>27</td><td></td><td>24</td><td>23</td><td>22</td><td></td><td>20</td><td>19</td><td>18</td></tr> <tr><td></td><td></td><td></td><td></td><td>16</td><td></td><td></td><td></td><td>13</td><td>12</td><td>11</td><td>10</td><td>9</td><td>7</td><td></td><td>4</td><td></td><td></td></tr> </table>		71	69	68	67	65	64	63		61	59	57	56							50	49	47					41	39	38	37	36		34	33				73	32	31	30	29	28	27		24	23	22		20	19	18					16				13	12	11	10	9	7		4										
	71	69	68	67	65	64	63		61	59	57	56																																																																									
		50	49	47					41	39	38	37	36		34	33																																																																					
			73	32	31	30	29	28	27		24	23	22		20	19	18																																																																				
				16				13	12	11	10	9	7		4																																																																						
AVAILABLE	NOT APPLICABLE	34566-2653	G	0	A	BLACK	<table border="1"> <tr><td></td><td>71</td><td>69</td><td>68</td><td>67</td><td>65</td><td>64</td><td></td><td></td><td>61</td><td>59</td><td>57</td><td>56</td><td></td><td></td><td></td><td>33</td></tr> <tr><td></td><td></td><td>50</td><td>49</td><td>47</td><td></td><td></td><td></td><td></td><td>41</td><td>39</td><td>38</td><td>37</td><td>36</td><td></td><td></td><td></td></tr> <tr><td></td><td></td><td></td><td>73</td><td>32</td><td>31</td><td>30</td><td>29</td><td>28</td><td>27</td><td></td><td>24</td><td>23</td><td>22</td><td></td><td>20</td><td>19</td><td>18</td></tr> <tr><td></td><td></td><td></td><td></td><td>16</td><td></td><td></td><td></td><td></td><td>11</td><td>10</td><td>9</td><td>7</td><td></td><td>4</td><td></td><td></td><td></td></tr> </table>		71	69	68	67	65	64			61	59	57	56				33			50	49	47					41	39	38	37	36							73	32	31	30	29	28	27		24	23	22		20	19	18					16					11	10	9	7		4											
	71	69	68	67	65	64			61	59	57	56				33																																																																					
		50	49	47					41	39	38	37	36																																																																								
			73	32	31	30	29	28	27		24	23	22		20	19	18																																																																				
				16					11	10	9	7		4																																																																							
AVAILABLE	NOT APPLICABLE	34566-2663	G	0	H	ST GRAY	<table border="1"> <tr><td></td><td>79</td><td>78</td><td>77</td><td>76</td><td>75</td><td>74</td><td>73</td><td>72</td><td>71</td><td>70</td><td>69</td><td>68</td><td></td><td>66</td><td>65</td><td>64</td><td>63</td><td>61</td></tr> <tr><td>60</td><td>59</td><td>58</td><td>57</td><td>56</td><td></td><td></td><td>53</td><td>52</td><td></td><td>50</td><td></td><td></td><td></td><td></td><td></td><td>44</td><td>43</td><td>41</td></tr> <tr><td>40</td><td>39</td><td>38</td><td>37</td><td></td><td>35</td><td>34</td><td></td><td>32</td><td></td><td>30</td><td>29</td><td></td><td>27</td><td>26</td><td></td><td></td><td></td><td>22</td><td>21</td></tr> <tr><td>20</td><td>19</td><td>18</td><td>17</td><td></td><td></td><td></td><td>13</td><td>12</td><td></td><td></td><td></td><td>8</td><td></td><td>6</td><td>5</td><td></td><td>3</td><td>2</td><td></td></tr> </table>		79	78	77	76	75	74	73	72	71	70	69	68		66	65	64	63	61	60	59	58	57	56			53	52		50						44	43	41	40	39	38	37		35	34		32		30	29		27	26				22	21	20	19	18	17				13	12				8		6	5		3	2	
	79	78	77	76	75	74	73	72	71	70	69	68		66	65	64	63	61																																																																			
60	59	58	57	56			53	52		50						44	43	41																																																																			
40	39	38	37		35	34		32		30	29		27	26				22	21																																																																		
20	19	18	17				13	12				8		6	5		3	2																																																																			
AVAILABLE	NOT APPLICABLE	34566-2673	G	0	H	ST GRAY	<table border="1"> <tr><td></td><td>79</td><td>78</td><td>77</td><td>76</td><td>75</td><td>74</td><td>73</td><td>72</td><td>71</td><td>70</td><td>69</td><td>68</td><td></td><td>66</td><td>65</td><td>64</td><td>63</td><td>61</td></tr> <tr><td>60</td><td>59</td><td>58</td><td>57</td><td>56</td><td></td><td></td><td>53</td><td>52</td><td></td><td>50</td><td></td><td></td><td></td><td></td><td></td><td>44</td><td>43</td><td>41</td></tr> <tr><td>40</td><td>39</td><td>38</td><td>37</td><td></td><td>35</td><td>34</td><td></td><td>32</td><td></td><td>30</td><td>29</td><td></td><td>27</td><td>26</td><td></td><td></td><td></td><td>22</td><td>21</td></tr> <tr><td>20</td><td>19</td><td>18</td><td>17</td><td>16</td><td></td><td></td><td>13</td><td>12</td><td></td><td></td><td></td><td>8</td><td></td><td>6</td><td>5</td><td></td><td>3</td><td>2</td><td></td></tr> </table>		79	78	77	76	75	74	73	72	71	70	69	68		66	65	64	63	61	60	59	58	57	56			53	52		50						44	43	41	40	39	38	37		35	34		32		30	29		27	26				22	21	20	19	18	17	16			13	12				8		6	5		3	2	
	79	78	77	76	75	74	73	72	71	70	69	68		66	65	64	63	61																																																																			
60	59	58	57	56			53	52		50						44	43	41																																																																			
40	39	38	37		35	34		32		30	29		27	26				22	21																																																																		
20	19	18	17	16			13	12				8		6	5		3	2																																																																			

ENTER DESCRIPTION TEC NO. UAU2010-1551 DRAWN BY: CHYKORFF CHECKED BY: CHYKORFF APPR: VKOSHY DATE: 2010/03/18	QUALITY SYMBOLS ▽=0 ▽=0	GENERAL TOLERANCES (UNLESS SPECIFIED) mm INCH 4 PLACES ±--- ±--- 3 PLACES ±--- ±--- 2 PLACES ±--- ±--- 1 PLACE ±--- ±--- ANGULAR ±---°	DIMENSION STYLE MM ONLY	SCALE 1:1	DESIGN UNITS METRIC	THIRD ANGLE PROJECTION 	
	DRAFT WHERE APPLICABLE MUST REMAIN WITHIN DIMENSIONS		DRAWN BY: SRAJENDRANAT CHECKED BY: TSK IVER APPROVED BY: VKOSHY DATE: 2008/05/09	TITLE MX123 73/80 CKT HRNS CONN ASSY	MATERIAL NO. NOT SEE BOM TABLE	DOCUMENT NO. SD-34566-001	SHEET NO. 31 OF 36
	MOLEX INCORPORATED						
	THIS DRAWING CONTAINS INFORMATION THAT IS PROPRIETARY TO MOLEX INCORPORATED AND SHOULD NOT BE USED WITHOUT WRITTEN PERMISSION						

STATUS	GM PART #	MATERIAL #	PART/MATERIAL REVISION	WIRE DRESS OPTION	KEY OPTION	COLOR (TPA)	NUMBERS INDICATE CAVITIES OPEN FOR CIRCUITS															
AVAILABLE	NOT APPLICABLE	34566-2893	G	0	A	BLACK	72		69	67	65	63		60		57	56		53			
									49	47	46	44	43		40		37	36	35	33		
							73		31	30	29	28		24		21	20		17			
									16	15	14	13		11	10			5	4	3	2	1
AVAILABLE	NOT APPLICABLE	34566-2913	G	0	B	ST GRAY			68	67		64					58					
										46	45						38					
							73		32	30	29	28	27			22						17
									15	13			10									1
AVAILABLE	NOT APPLICABLE	34566-2923	G	0	B	ST GRAY			68	67		64										
										46	45											
							73		32	30	29	28	27									17
									15	13			10									
AVAILABLE	NOT APPLICABLE	34566-2933	G	0	A	BLACK	72		69	67	65	63		60		57	56		53			
									49	47		44	43		40		37	36	35	33		
							73		31	30	29	28		24		21	20		17			
									16	15	14		11	10				5	4	3	2	1
AVAILABLE	NOT APPLICABLE	34566-2943	G	0	B	ST GRAY			68	67		64	63		59	57						
										46	45	43			39	37						
									32	30	29	28	27			21						
													10			6	5	4	3			
AVAILABLE	NOT APPLICABLE	34566-2953	G	0	B	ST GRAY			68	67		64	63		59							34
										46	45	43			39							
									32	30	29	28	27									
													10			6	5	4	3			
AVAILABLE	NOT APPLICABLE	34566-2963	G	0	H	ST GRAY	79			74	73	72	71	69	68	67		64	62	61		
							59			54	53	52		49	48	47			42	41		
								38			33			29	27		25					21
										15	14		11	10	9	8	7					
AVAILABLE	NOT APPLICABLE	34566-2973	G	0	G	BLUE	80	78	77	76	75	74	73	72	70	69	67	65	64	63	62	
							60	58	57	56	55	54	52	51	50	49	47	45				
							40	38	37			33	32	31			27	26	25	24		
							20	18	17						10	9	8	6	5	3	2	1

ENTER DESCRIPTION TEC NO: JAU2010-1551 DRAWN BY: 2010/03/15 CHKD: GRIFFITHS 2008/05/09 APPR: VKOSHY 2010/03/18	QUALITY SYMBOLS	GENERAL TOLERANCES (UNLESS SPECIFIED)	DIMENSION STYLE	SCALE	DESIGN UNITS	THIRD ANGLE PROJECTION
	▽=0	mm INCH	MM ONLY	2:1	METRIC	☉
	▽=0	4 PLACES ± --- ± ---	DRAWN BY DATE	TITLE		
	▽=0	3 PLACES ± --- ± ---	SRAJENDRANAT 2008/05/09	MX123 73/80 CKT HRNS CONN ASSY		
▽=0	2 PLACES ± --- ± ---	CHECKED BY DATE	MOLEX INCORPORATED			
▽=0	1 PLACE ± --- ± ---	TSK IVER 2008/05/09	SD-34566-001			
	ANGULAR ± ---°	APPROVED BY DATE	SHEET NO. 34 OF 36			
		VKOSHY 2010/03/18	THIS DRAWING CONTAINS INFORMATION THAT IS PROPRIETARY TO MOLEX INCORPORATED AND SHOULD NOT BE USED WITHOUT WRITTEN PERMISSION			
	DRAFT WHERE APPLICABLE MUST REMAIN WITHIN DIMENSIONS	MATERIAL NO.	DOCUMENT NO.			
		SEE BOM TABLE				

STATUS	GM PART #	MATERIAL #	PART / MATERIAL REVISION	WIRE DRESS OPTION	KEY OPTION	COLOR (TPA)	NUMBERS INDICATE CAVITIES OPEN FOR CIRCUITS																																																																																																				
AVAILABLE	NOT APPLICABLE	34566-9913	G	0	A	BLACK	<table border="1"> <tr><td>72</td><td>71</td><td></td><td></td><td>68</td><td>67</td><td>66</td><td>65</td><td>64</td><td></td><td></td><td></td><td></td><td></td><td>59</td><td></td><td></td><td></td><td></td><td></td></tr> <tr><td></td><td></td><td>50</td><td></td><td>48</td><td>47</td><td>46</td><td>45</td><td></td><td></td><td></td><td></td><td></td><td></td><td>40</td><td>39</td><td>38</td><td></td><td></td><td></td></tr> <tr><td></td><td></td><td></td><td></td><td>31</td><td>30</td><td></td><td></td><td></td><td></td><td></td><td></td><td></td><td>25</td><td>24</td><td></td><td>22</td><td>21</td><td>20</td><td></td></tr> <tr><td></td><td></td><td></td><td></td><td></td><td></td><td>14</td><td></td><td></td><td></td><td></td><td></td><td></td><td></td><td>9</td><td>7</td><td>6</td><td>5</td><td>4</td><td></td></tr> <tr><td></td><td></td><td></td><td></td><td></td><td></td><td></td><td></td><td></td><td></td><td></td><td></td><td></td><td></td><td></td><td></td><td></td><td></td><td>2</td><td>1</td></tr> </table>	72	71			68	67	66	65	64						59								50		48	47	46	45							40	39	38								31	30								25	24		22	21	20								14								9	7	6	5	4																				2	1
72	71			68	67	66	65	64						59																																																																																													
		50		48	47	46	45							40	39	38																																																																																											
				31	30								25	24		22	21	20																																																																																									
						14								9	7	6	5	4																																																																																									
																		2	1																																																																																								
AVAILABLE	NOT APPLICABLE	34566-9923	G	0	A	BLACK	<table border="1"> <tr><td>72</td><td>71</td><td></td><td></td><td></td><td>67</td><td>66</td><td></td><td></td><td></td><td>62</td><td>61</td><td>60</td><td></td><td></td><td>57</td><td></td><td>55</td><td>54</td></tr> <tr><td></td><td>51</td><td></td><td></td><td>48</td><td>46</td><td>45</td><td>44</td><td>43</td><td>42</td><td></td><td></td><td></td><td>39</td><td></td><td></td><td></td><td>35</td><td>33</td></tr> <tr><td></td><td></td><td></td><td></td><td></td><td>15</td><td>14</td><td></td><td></td><td></td><td></td><td></td><td></td><td>8</td><td>7</td><td>6</td><td>5</td><td>4</td><td>3</td></tr> <tr><td></td><td></td><td></td><td></td><td></td><td></td><td></td><td></td><td></td><td></td><td></td><td></td><td></td><td></td><td></td><td></td><td></td><td></td><td>2</td></tr> </table>	72	71				67	66				62	61	60			57		55	54		51			48	46	45	44	43	42				39				35	33						15	14							8	7	6	5	4	3																			2																								
72	71				67	66				62	61	60			57		55	54																																																																																									
	51			48	46	45	44	43	42				39				35	33																																																																																									
					15	14							8	7	6	5	4	3																																																																																									
																		2																																																																																									
AVAILABLE	NOT APPLICABLE	34566-9933	G	0	B	ST GRAY	<table border="1"> <tr><td></td><td></td><td>69</td><td></td><td></td><td>65</td><td>64</td><td>63</td><td></td><td></td><td></td><td></td><td></td><td></td><td></td><td></td><td></td><td></td><td></td><td></td></tr> <tr><td></td><td></td><td>49</td><td></td><td></td><td>45</td><td>44</td><td>43</td><td></td><td></td><td></td><td></td><td></td><td></td><td></td><td></td><td></td><td></td><td></td><td></td></tr> <tr><td></td><td></td><td></td><td></td><td></td><td></td><td></td><td></td><td></td><td></td><td></td><td></td><td></td><td></td><td></td><td>22</td><td>21</td><td>20</td><td>19</td><td>18</td></tr> <tr><td></td><td></td><td></td><td></td><td></td><td></td><td></td><td>12</td><td>11</td><td></td><td></td><td></td><td></td><td></td><td></td><td>6</td><td>5</td><td>4</td><td>3</td><td>2</td></tr> </table>			69			65	64	63															49			45	44	43																												22	21	20	19	18								12	11							6	5	4	3	2																				
		69			65	64	63																																																																																																				
		49			45	44	43																																																																																																				
															22	21	20	19	18																																																																																								
							12	11							6	5	4	3	2																																																																																								
AVAILABLE	NOT APPLICABLE	34566-9943	G	0	C	BLUE	<table border="1"> <tr><td></td><td>71</td><td>69</td><td></td><td></td><td>65</td><td>64</td><td></td><td></td><td>61</td><td>60</td><td></td><td></td><td>58</td><td></td><td>56</td><td>55</td><td>54</td><td></td></tr> <tr><td></td><td></td><td>50</td><td>49</td><td></td><td>45</td><td>43</td><td>41</td><td></td><td></td><td></td><td></td><td></td><td>37</td><td>36</td><td>35</td><td></td><td></td><td></td></tr> <tr><td></td><td></td><td></td><td></td><td>31</td><td>29</td><td>28</td><td></td><td></td><td>24</td><td>23</td><td></td><td></td><td></td><td></td><td>19</td><td>18</td><td>17</td><td></td></tr> <tr><td></td><td></td><td></td><td></td><td>16</td><td></td><td>13</td><td>12</td><td>11</td><td></td><td>8</td><td>7</td><td></td><td></td><td></td><td></td><td></td><td>3</td><td>2</td></tr> </table>		71	69			65	64			61	60			58		56	55	54				50	49		45	43	41						37	36	35								31	29	28			24	23					19	18	17						16		13	12	11		8	7						3	2																								
	71	69			65	64			61	60			58		56	55	54																																																																																										
		50	49		45	43	41						37	36	35																																																																																												
				31	29	28			24	23					19	18	17																																																																																										
				16		13	12	11		8	7						3	2																																																																																									
AVAILABLE	NOT APPLICABLE	34566-9953	G	0	A	BLACK	<table border="1"> <tr><td></td><td></td><td></td><td></td><td>67</td><td></td><td></td><td></td><td>62</td><td></td><td>60</td><td></td><td></td><td>57</td><td></td><td>55</td><td></td><td></td><td></td></tr> <tr><td></td><td></td><td>51</td><td></td><td>48</td><td>46</td><td>45</td><td>44</td><td>43</td><td></td><td></td><td></td><td>39</td><td></td><td></td><td>35</td><td></td><td></td><td></td></tr> <tr><td></td><td></td><td></td><td></td><td></td><td>15</td><td>14</td><td></td><td></td><td></td><td></td><td></td><td>7</td><td>6</td><td>5</td><td>4</td><td>3</td><td>2</td><td></td></tr> <tr><td></td><td></td><td></td><td></td><td></td><td></td><td></td><td></td><td></td><td></td><td></td><td></td><td></td><td></td><td></td><td></td><td></td><td></td><td></td></tr> </table>					67				62		60			57		55						51		48	46	45	44	43				39			35									15	14						7	6	5	4	3	2																																												
				67				62		60			57		55																																																																																												
		51		48	46	45	44	43				39			35																																																																																												
					15	14						7	6	5	4	3	2																																																																																										
AVAILABLE	NOT APPLICABLE	34566-9963	G	0	B	ST GRAY	<table border="1"> <tr><td></td><td></td><td></td><td></td><td>68</td><td>67</td><td></td><td></td><td>64</td><td>63</td><td></td><td></td><td></td><td>58</td><td></td><td>55</td><td></td><td></td><td></td></tr> <tr><td></td><td></td><td></td><td></td><td></td><td></td><td>46</td><td>45</td><td>43</td><td></td><td></td><td></td><td></td><td>38</td><td></td><td>35</td><td></td><td></td><td></td></tr> <tr><td></td><td></td><td>73</td><td></td><td>32</td><td>30</td><td>29</td><td>28</td><td>27</td><td></td><td></td><td></td><td></td><td>22</td><td></td><td>19</td><td>17</td><td></td><td></td></tr> <tr><td></td><td></td><td></td><td></td><td>15</td><td>13</td><td></td><td></td><td>10</td><td></td><td></td><td></td><td></td><td></td><td></td><td></td><td></td><td></td><td>1</td></tr> </table>					68	67			64	63				58		55										46	45	43					38		35						73		32	30	29	28	27					22		19	17							15	13			10										1																								
				68	67			64	63				58		55																																																																																												
						46	45	43					38		35																																																																																												
		73		32	30	29	28	27					22		19	17																																																																																											
				15	13			10										1																																																																																									
AVAILABLE	NOT APPLICABLE	34566-9973	G	0	B	ST GRAY	<table border="1"> <tr><td></td><td></td><td></td><td></td><td>68</td><td>67</td><td></td><td></td><td>64</td><td>63</td><td></td><td></td><td></td><td>58</td><td></td><td></td><td></td><td></td><td></td></tr> <tr><td></td><td></td><td></td><td></td><td></td><td></td><td>46</td><td>45</td><td>43</td><td></td><td></td><td></td><td></td><td>38</td><td></td><td></td><td></td><td></td><td></td></tr> <tr><td></td><td></td><td></td><td></td><td>32</td><td>30</td><td>29</td><td>28</td><td>27</td><td></td><td></td><td></td><td></td><td>22</td><td></td><td></td><td></td><td></td><td>17</td></tr> <tr><td></td><td></td><td></td><td></td><td>15</td><td>13</td><td></td><td></td><td>10</td><td></td><td></td><td></td><td></td><td></td><td></td><td></td><td></td><td></td><td></td></tr> </table>					68	67			64	63				58												46	45	43					38										32	30	29	28	27					22					17					15	13			10																																		
				68	67			64	63				58																																																																																														
						46	45	43					38																																																																																														
				32	30	29	28	27					22					17																																																																																									
				15	13			10																																																																																																			

ENTER DESCRIPTION TEC NO: JAU2010-1551 DRAWN BY: 2010/03/15 CHKD:DRFF HS 2008/05/09 APPR:VKOSHY 2010/03/18	QUALITY SYMBOLS ∇=0 ∇=0 ∇=0	GENERAL TOLERANCES (UNLESS SPECIFIED) <table border="1"> <tr><th></th><th>mm</th><th>INCH</th></tr> <tr><td>4 PLACES</td><td>±---</td><td>±---</td></tr> <tr><td>3 PLACES</td><td>±---</td><td>±---</td></tr> <tr><td>2 PLACES</td><td>±---</td><td>±---</td></tr> <tr><td>1 PLACE</td><td>±---</td><td>±---</td></tr> </table>		mm	INCH	4 PLACES	±---	±---	3 PLACES	±---	±---	2 PLACES	±---	±---	1 PLACE	±---	±---	DIMENSION STYLE MM ONLY	SCALE 1:1	DESIGN UNITS METRIC	THIRD ANGLE PROJECTION
		mm	INCH																		
	4 PLACES	±---	±---																		
	3 PLACES	±---	±---																		
2 PLACES	±---	±---																			
1 PLACE	±---	±---																			
DRAWN BY: SRAJENDRANAT DATE: 2008/05/09 CHECKED BY: TSK IVER DATE: 2008/05/09 APPROVED BY: VKOSHY DATE: 2010/03/18	DRAFT WHERE APPLICABLE MUST REMAIN WITHIN DIMENSIONS		MATERIAL NO: SEE BOM TABLE	DOCUMENT NO: SD-34566-001	TITLE MX123 73/80 CKT HRNS CONN ASSY	SHEET NO. 35 OF 36															
ANGULAR ±----			MOLEX INCORPORATED																		
THIS DRAWING CONTAINS INFORMATION THAT IS PROPRIETARY TO MOLEX INCORPORATED AND SHOULD NOT BE USED WITHOUT WRITTEN PERMISSION																					

