

**PLEASE CHECK WWW.MOLEX.COM FOR LATEST PART INFORMATION**

**Part Number:** **0345662003**  
**Status:** **Active**  
**Overview:** mx123 sealed connection systems  
**Description:** 2.54mm (.100") Pitch, MX123 Female Receptacle Housing, Keying Option H, Wire Dress Option 9, 80 Circuits, Gray TPA

**Documents:**

[Drawing \(PDF\)](#) [RoHS Certificate of Compliance \(PDF\)](#)  
[Product Specification PS-34566-0000 \(PDF\)](#)

**General**

Product Family	Crimp Housings
Series	<u>34566</u>
Comments	See Sales Drawing for number of Open Circuits
Overview	<u>mx123 sealed connection systems</u>
Product Name	MX123

**Physical**

Circuits (maximum)	80
Circuits Detail	80
Color - Resin	Gray
Gender	Female
Glow-Wire Compliant	No
Keying to Mating Part	Yes
Lock to Mating Part	Yes
Material - Resin	Nylon
Number of Rows	4
Packaging Type	Tray
Panel Mount	No
Pitch - Mating Interface (in)	0.100 In
Pitch - Mating Interface (mm)	2.54 mm
Pitch - Term. Interface (in)	0.100 In
Pitch - Term. Interface (mm)	2.54 mm
Polarized to Mating Part	Yes
Stackable	No
Temperature Range - Operating	-40°C to +125°C

**Electrical**

Current - Maximum per Contact	11A, 25A
-------------------------------	----------

**Material Info**

**Reference - Drawing Numbers**

Application Specification	AS-34566-001
Product Specification	PS-34566-0000



**EU RoHS**

**ELV and RoHS Compliant**  
**REACH SVHC**  
 Not Reviewed  
**Halogen-Free**  
**Status**  
**Not Reviewed**

**China RoHS**



**Need more information on product environmental compliance?**

Email [productcompliance@molex.com](mailto:productcompliance@molex.com)  
 For a multiple part number RoHS Certificate of Compliance, [click here](#)

Please visit the [Contact Us](#) section for any non-product compliance questions.

**Search Parts in this Series**

34566Series

**Mates With**

MX123 Female Header 31386 , 31387

**Use With**

MX64 Female Terminals 33467

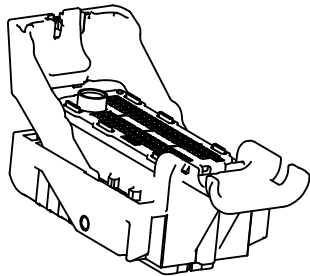

73 CKT  
SCALE 3:2

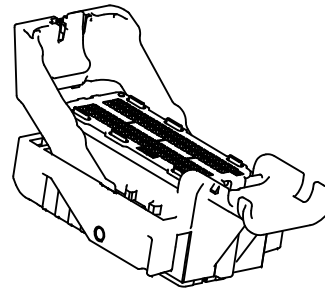
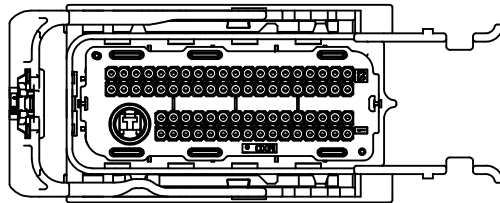

80 CKT  
SCALE 3:2

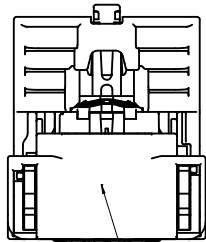

RECOMMENDED LOCATION  
FOR NOTE 2D

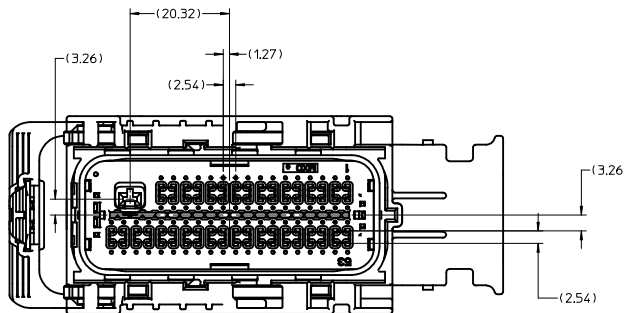
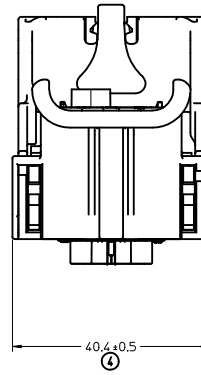
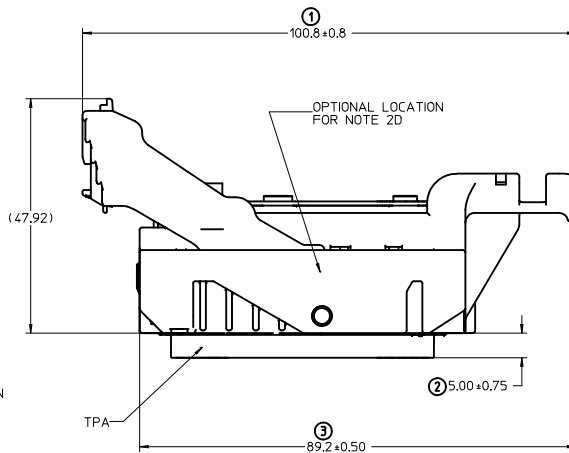

NOTES: UNLESS OTHERWISE SPECIFIED

1. MATERIAL:

- A. RESIN: SEE COMPONENT DRAWINGS
- B. COLOR: SEE TABLE

2. DESIGN - GENERAL:

- A. THIS IS A 100% CAD GENERATED PART. THE CAD MATHEMATICAL DATA IS THE MASTER FOR THIS PART. FOR DIMENSIONAL OR ANY INFORMATION NOT SHOWN ON THIS DRAWING, ANALYZE THE CAD MODEL.
- B. TOLERANCES:
  - a. LINEAR XX ± 0.30
  - XXX ± 0.10
  - XXXX ± 0.10
  - b. ANGULAR X° ± 3.0°
- C. CORNERS SHOWN AS SHARP TO BE R 0.2 MAX.
- D. FOLLOWING PRODUCTION CODES TO BE PERMANENTLY MARKED & HUMAN READABLE TO A LETTER HEIGHT < 3mm.
  - LINE #1: MATERIAL #: XXXX-XXXX
  - LINE #2: DATE CODE: JJYY (JULIAN DAY, LAST DIGIT OF YEAR)
  - LINE #3: INSPECTION MACHINE CODE # SERIAL #X\_XXXX
- E-1. PARTS MUST BE FREE OF DISCOLORATION, SALT RESIDUE AND OTHER IMPERFECTIONS THAT AFFECT FIT OR FUNCTION.
- E-2. SCRATCHES OR DENTS NOT TO EXCEED 0.10mm IN DEPTH.
- F. CHANGES IN DESIGN FROM PART PREVIOUSLY APPROVED REQUIRES PRIOR ENGINEERING APPROVAL. THIS INCLUDES BUT IS NOT LIMITED TO DRAFT, MATERIAL OR PROCESSING.
- G. SHALL CONFORM TO THE FOLLOWING PACKAGING SPECIFICATION 300-019

3. DESIGN - MANUFACTURING:

- A. DRAFT TO BE WITHIN TOLERANCE.
- B. ALLOWABLE FLASH 0.2 MAX HIGH X 0.13 MAX THICK.
- C. ALLOWABLE PARTING LINE MISMATCH 0.2 MAX.
- D. EJECTOR PINS MARK TO BE FLUSH TO 0.25 MAX DEPRESSED.
- E. ALLOWABLE GATE VESTIGE TO BE FLUSH TO 0.25 MAX PROTRUSION.

4. SYSTEM REQUIREMENTS:

WHEN TESTED TO SAE/USCAR-2 REV. 3, APRIL 2001, AND GMW #3191, AUGUST 22, 2000 (DRAFT).

- A. TPA (WITHOUT TERMINALS)
  - a. INSERTION FORCE FROM PRE-SET TO LOCK: ≥20
  - b. REMOVAL FORCE FROM PRE-SET: ≥20
- B. CPA
  - a. INSERTION FORCE FROM PRE-SET TO LOCK WITH CONNECTOR UN-MATED: ≥60N
  - b. REMOVAL FORCE FROM PRE-SET: ≥30N
- C. GROMMET CAP
  - a. REMOVAL FORCE FROM HOUSING WITH ENGAGED LATCHES: ≥110N
- D. MATE ASSIST LEVER
  - a. INADVERTENT ACTUATION FORCE DURING SHIPPING, HANDLING OR PRE-ASSEMBLY: ≥190N

F40	REVISED DRAWING---CIRCUIT 73 IS OPEN ON MATERIAL NUMBER 34566-2983
F39	ADD PART NUMBERS
F38	ADD PART NUMBERS
F37	ADD PART NUMBERS
F36	ADD PART NUMBERS
F35	ADD PART NUMBERS
F34	ADD PART NUMBERS
F33	ADD PART NUMBERS
F32	ADD PART NUMBERS & SHEET 33
F31	ADD PART NUMBERS
F30	ASSY # 34566-2683---KEY OPT H WAS A. COLOR ST BRY WAS BLACK
F29	ADD PART NUMBERS
REV	DESCRIPTION

ENTER DESCRIPTION REC NO: UAU2010-1551 DRAWN BY: 2010/03/15 CHYK/DGR/FF/THS 2008/05/09 APPROV: VKOSHY 2010/03/18	QUALITY SYMBOLS ▽=0 ▽=0	GENERAL TOLERANCES (UNLESS SPECIFIED)		DIMENSION STYLE MM ONLY		SCALE 2:1	DESIGN UNITS METRIC	THIRD ANGLE PROJECTION	
		4 PLACES ±---+--- 3 PLACES ±---+--- 2 PLACES ±---+--- 1 PLACE ±---+---	mm INCH	DRAWN BY SRAJENDRANAT	DATE 2008/05/09	TITLE MX123 73/80 CKT HRNS CONN ASSY			
		ANGULAR ±---°	APPROVED BY VKOSHY	DATE 2010/03/18	MOLEX INCORPORATED				
		DRAFT WHERE APPLICABLE MUST REMAIN WITHIN DIMENSIONS	SEE BOM TABLE	MATERIAL NO. SD-34566-001	DOCUMENT NO.	SHEET NO. 1 OF 36	THIS DRAWING CONTAINS INFORMATION THAT IS PROPRIETARY TO MOLEX INCORPORATED AND SHOULD NOT BE USED WITHOUT WRITTEN PERMISSION		

20 19 18 17 16 15 14 13 12 11 10 9 8 7 6 5 4 3 2 1

**WIRE DRESS OPTION 0**  
HOUSING ONLY, SHOWN FOR CLARITY

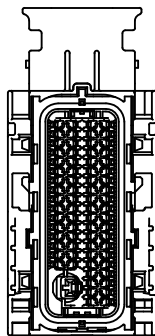

73 CKT  
KEY OPTION A

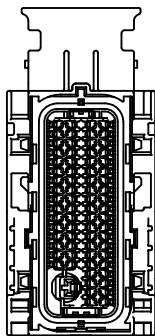

73 CKT  
KEY OPTION B

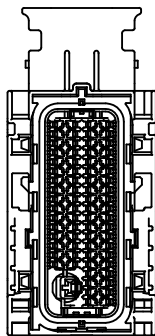

73 CKT  
KEY OPTION C

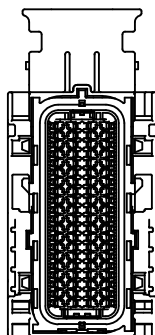

80 CKT  
KEY OPTION G

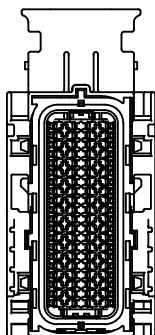

80 CKT  
KEY OPTION H

<b>ENTER DESCRIPTION</b> REC NO: UAU2010-1551 DRAWN BY: 2010/03/15 CHYKORRFF/THS 2008/05/09 APPR:VKOSHY 2010/03/18 REV:	QUALITY SYMBOLS	GENERAL TOLERANCES (UNLESS SPECIFIED)	DIMENSION STYLE	SCALE	DESIGN UNITS	THIRD ANGLE PROJECTION															
	▼=0 ▽=0	<table border="1"> <thead> <tr> <th></th> <th>mm</th> <th>INCH</th> </tr> </thead> <tbody> <tr> <td>4 PLACES</td> <td>±---</td> <td>±---</td> </tr> <tr> <td>3 PLACES</td> <td>±---</td> <td>±---</td> </tr> <tr> <td>2 PLACES</td> <td>±---</td> <td>±---</td> </tr> <tr> <td>1 PLACE</td> <td>±---</td> <td>±---</td> </tr> </tbody> </table> ANGULAR ±---°		mm	INCH	4 PLACES	±---	±---	3 PLACES	±---	±---	2 PLACES	±---	±---	1 PLACE	±---	±---	MM ONLY 1.5:1 METRIC	DRAWN BY: SRAJENDRANAT DATE: 2008/05/09 CHECKED BY: TSK IVER DATE: 2008/05/09 APPROVED BY: VKOSHY DATE: 2010/03/18	TITLE: MX123 73/80 CKT HRNS CONN ASSY	MOLEX INCORPORATED
		mm	INCH																		
	4 PLACES	±---	±---																		
3 PLACES	±---	±---																			
2 PLACES	±---	±---																			
1 PLACE	±---	±---																			
DRAFT WHERE APPLICABLE MUST REMAIN WITHIN DIMENSIONS	SEE BOM TABLE	MATERIAL NO: SD-34566-001	SHEET NO: 2 OF 36																		
SIZE D	THIS DRAWING CONTAINS INFORMATION THAT IS PROPRIETARY TO MOLEX INCORPORATED AND SHOULD NOT BE USED WITHOUT WRITTEN PERMISSION																				

19 18 17 16 15 14 13 12 11 10 9 8 7 6 5 4 3 2 1

20 19 18 17 16 15 14 13 12 11 10 9 8 7 6 5 4 3 2 1

**WIRE DRESS OPTION 9**  
HOUSING ONLY, SHOWN FOR CLARITY

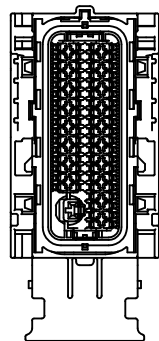

73 CKT  
KEY OPTION A

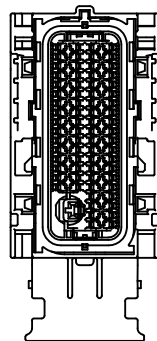

73 CKT  
KEY OPTION B

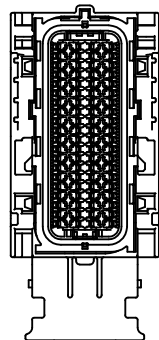

80 CKT  
KEY OPTION G

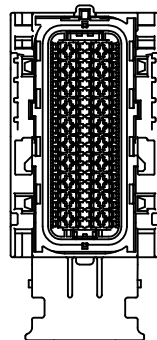

80 CKT  
KEY OPTION H

<b>ENTER DESCRIPTION</b> REC NO: UAU2010-1551 DRAWN BY: 2010/03/15 CHKD BY: FFJHS 2008/05/09 APPR: VKOSHY 2010/03/18	QUALITY SYMBOLS ▽=0 ▽=0	GENERAL TOLERANCES (UNLESS SPECIFIED)		DIMENSION STYLE <b>MM ONLY</b>	SCALE <b>1.5:1</b>	DESIGN UNITS <b>METRIC</b>	THIRD ANGLE PROJECTION
		4 PLACES #---# 3 PLACES #---# 2 PLACES #---# 1 PLACE #---#	mm INCH	DRAWN BY: SRAJENDRANAT DATE: 2008/05/09	TITLE <b>MX123 73/80 CKT HRNS CONN ASSY</b>		
		ANGULAR ±---°		CHECKED BY: TSK IVER DATE: 2008/05/09	APPROVED BY: VKOSHY DATE: 2010/03/18		
		DRAFT WHERE APPLICABLE MUST REMAIN WITHIN DIMENSIONS	SEE BOM TABLE	MATERIAL NO. DOCUMENT NO.		MOLEX INCORPORATED	

19 18 17 16 15 14 13 12 11 10 9 8 7 6 5 4 3 2 1

WIRE DRESS OPTION 0

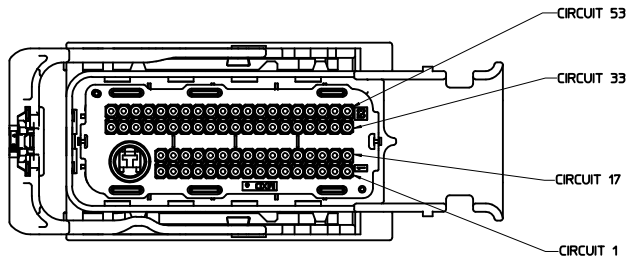

73 CKT

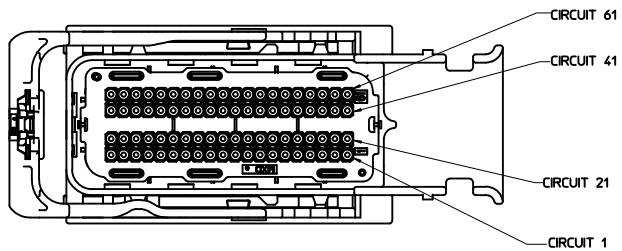

80 CKT

WIRE DRESS OPTION 9

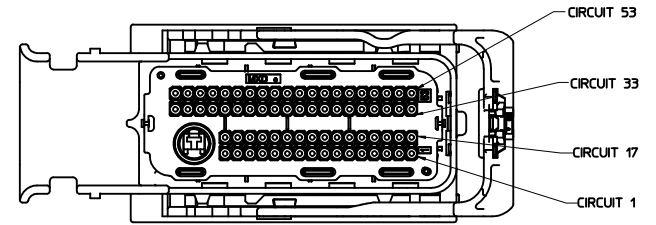

73 CKT

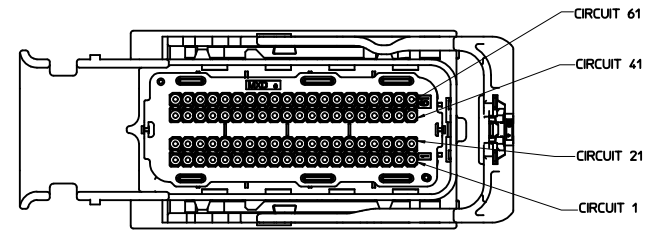

80 CKT

<b>ENTER DESCRIPTION</b> ECN NO: UAU2010-1551 DRAWN BY: DRWNAH01 CHECKED BY: CHKDGRFFHIS APPROVED BY: APPR.VKOSHY DATE: 2010/03/15 DATE: 2008/05/09 DATE: 2010/03/18	<b>QUALITY SYMBOLS</b> ▽=0 ▽=0	<b>GENERAL TOLERANCES (UNLESS SPECIFIED)</b>		<b>DIMENSION STYLE</b> MM ONLY	SCALE 2:1	DESIGN UNITS METRIC	THIRD ANGLE PROJECTION		
		4 PLACES ±---+--- 3 PLACES ±---+--- 2 PLACES ±---+--- 1 PLACE ±---+---	mm    INCH	DRAWN BY: SRAJENDRANAT DATE: 2008/05/09	CHECKED BY: TSKIVER DATE: 2008/05/09	TITLE MX123 73/80 CKT HRNS CONN ASSY			
		ANGULAR ±---°		APPROVED BY: VKOSHY DATE: 2010/03/18	MOLEX INCORPORATED				
		DRAFT WHERE APPLICABLE MUST REMAIN WITHIN DIMENSIONS		SEE BOM TABLE	MATERIAL NO. SD-34566-001	DOCUMENT NO. SD-34566-001	SHEET NO. 4 OF 36		



20 19 18 17 16 15 14 13 12 11 10 9 8 7 6 5 4 3 2 1

STATUS	GM PART #	MATERIAL #	PART/MATERIAL REVISION	WIRE DRESS OPTION	KEY OPTION	COLOR (TPA)	NUMBERS INDICATE CAVITIES OPEN FOR CIRCUITS																																																																																																																																																																																																																																																																																																																																																																																																																																																																																																																																																																																																													
AVAILABLE	NOT APPLICABLE	34566-2803	G	0	H	ST GR																																																																																																																																																																																																																																																																																																																																																																																																																																																																																																																																																																																																														
AVAILABLE	NOT APPLICABLE	34566-2903	G	0	A	BLACK	72	71	70	69	68	67	66	64	63	62	61	59			55	54	53								52	51	49	48	47	46	44	43	42	41	39			35	34	33								73			32	31	29	27	25	23			19	18	17											16		13	12	11	9	8	7	6	5	4	3	2	1	AVAILABLE	NOT APPLICABLE	34566-3003	G	0	A	BLACK	72	71	70	69	68	67	66	64	63	62	60	59	58	57	56	55	54	53								52	51	50	49	48	47	46	44	43	42	41	40	39	38	37	36	35	34	33								73			32	31	30	29	28	27	25	24	23	22	21	20	19	18	17											16	15	14	13	12	11	9	8	7	6	5	4	3	2	1	AVAILABLE	NOT APPLICABLE	34566-3103	G	0	B	ST GR							65		62		59		57		55		53											49	48		46		42		39		37		35		33								73						29		26		23		21				18																	9	8	7			4	3			AVAILABLE	NOT APPLICABLE	34566-3203	G	0	B	ST GR							67				60	59	58	57	56	55	53										50	49	48		46				39	38	37		35	34	33								73						29			23	22	21			18																	7	6	5	4	3			AVAILABLE	NOT APPLICABLE	34566-3303	G	0	B	ST GR											59	58	57	56	55	53										50	49	48		46				39	38	37		35	34	33								73						29			23	22	21			18																	7	6	5	4	3			AVAILABLE	NOT APPLICABLE	34566-3403	SEE 34566-3003																AVAILABLE	NOT APPLICABLE	34566-3503	G	0	A	BLACK	72	71	70	69	68	67	66	64	63	62	60	59													52		49	48		46		44	43	42	40	39					35	34	33								73						32		29		27		24	23			19	18	17																			9	8	7	6	5	4	3	2	1
							52	51	49	48	47	46	44	43	42	41	39			35	34	33								73			32	31	29	27	25	23			19	18	17											16		13	12	11	9	8	7	6	5	4	3	2	1	AVAILABLE	NOT APPLICABLE	34566-3003	G	0	A	BLACK	72	71	70	69	68	67	66	64	63	62	60	59	58	57	56	55	54	53								52	51	50	49	48	47	46	44	43	42	41	40	39	38	37	36	35	34	33								73			32	31	30	29	28	27	25	24	23	22	21	20	19	18	17											16	15	14	13	12	11	9	8	7	6	5	4	3	2	1	AVAILABLE	NOT APPLICABLE	34566-3103	G	0	B	ST GR							65		62		59		57		55		53											49	48		46		42		39		37		35		33								73						29		26		23		21				18																	9	8	7			4	3			AVAILABLE	NOT APPLICABLE	34566-3203	G	0	B	ST GR							67				60	59	58	57	56	55	53										50	49	48		46				39	38	37		35	34	33								73						29			23	22	21			18																	7	6	5	4	3			AVAILABLE	NOT APPLICABLE	34566-3303	G	0	B	ST GR											59	58	57	56	55	53										50	49	48		46				39	38	37		35	34	33								73						29			23	22	21			18																	7	6	5	4	3			AVAILABLE	NOT APPLICABLE	34566-3403	SEE 34566-3003																AVAILABLE	NOT APPLICABLE	34566-3503	G	0	A	BLACK	72	71	70	69	68	67	66	64	63	62	60	59													52		49	48		46		44	43	42	40	39					35	34	33								73						32		29		27		24	23			19	18	17																			9	8	7	6	5	4	3	2	1																								
							73			32	31	29	27	25	23			19	18	17											16		13	12	11	9	8	7	6	5	4	3	2	1	AVAILABLE	NOT APPLICABLE	34566-3003	G	0	A	BLACK	72	71	70	69	68	67	66	64	63	62	60	59	58	57	56	55	54	53								52	51	50	49	48	47	46	44	43	42	41	40	39	38	37	36	35	34	33								73			32	31	30	29	28	27	25	24	23	22	21	20	19	18	17											16	15	14	13	12	11	9	8	7	6	5	4	3	2	1	AVAILABLE	NOT APPLICABLE	34566-3103	G	0	B	ST GR							65		62		59		57		55		53											49	48		46		42		39		37		35		33								73						29		26		23		21				18																	9	8	7			4	3			AVAILABLE	NOT APPLICABLE	34566-3203	G	0	B	ST GR							67				60	59	58	57	56	55	53										50	49	48		46				39	38	37		35	34	33								73						29			23	22	21			18																	7	6	5	4	3			AVAILABLE	NOT APPLICABLE	34566-3303	G	0	B	ST GR											59	58	57	56	55	53										50	49	48		46				39	38	37		35	34	33								73						29			23	22	21			18																	7	6	5	4	3			AVAILABLE	NOT APPLICABLE	34566-3403	SEE 34566-3003																AVAILABLE	NOT APPLICABLE	34566-3503	G	0	A	BLACK	72	71	70	69	68	67	66	64	63	62	60	59													52		49	48		46		44	43	42	40	39					35	34	33								73						32		29		27		24	23			19	18	17																			9	8	7	6	5	4	3	2	1																																															
										16		13	12	11	9	8	7	6	5	4	3	2	1																																																																																																																																																																																																																																																																																																																																																																																																																																																																																																																																																																																													
AVAILABLE	NOT APPLICABLE	34566-3003	G	0	A	BLACK	72	71	70	69	68	67	66	64	63	62	60	59	58	57	56	55	54	53								52	51	50	49	48	47	46	44	43	42	41	40	39	38	37	36	35	34	33								73			32	31	30	29	28	27	25	24	23	22	21	20	19	18	17											16	15	14	13	12	11	9	8	7	6	5	4	3	2	1	AVAILABLE	NOT APPLICABLE	34566-3103	G	0	B	ST GR							65		62		59		57		55		53											49	48		46		42		39		37		35		33								73						29		26		23		21				18																	9	8	7			4	3			AVAILABLE	NOT APPLICABLE	34566-3203	G	0	B	ST GR							67				60	59	58	57	56	55	53										50	49	48		46				39	38	37		35	34	33								73						29			23	22	21			18																	7	6	5	4	3			AVAILABLE	NOT APPLICABLE	34566-3303	G	0	B	ST GR											59	58	57	56	55	53										50	49	48		46				39	38	37		35	34	33								73						29			23	22	21			18																	7	6	5	4	3			AVAILABLE	NOT APPLICABLE	34566-3403	SEE 34566-3003																AVAILABLE	NOT APPLICABLE	34566-3503	G	0	A	BLACK	72	71	70	69	68	67	66	64	63	62	60	59													52		49	48		46		44	43	42	40	39					35	34	33								73						32		29		27		24	23			19	18	17																			9	8	7	6	5	4	3	2	1																																																																																												
							52	51	50	49	48	47	46	44	43	42	41	40	39	38	37	36	35	34	33								73			32	31	30	29	28	27	25	24	23	22	21	20	19	18	17											16	15	14	13	12	11	9	8	7	6	5	4	3	2	1	AVAILABLE	NOT APPLICABLE	34566-3103	G	0	B	ST GR							65		62		59		57		55		53											49	48		46		42		39		37		35		33								73						29		26		23		21				18																	9	8	7			4	3			AVAILABLE	NOT APPLICABLE	34566-3203	G	0	B	ST GR							67				60	59	58	57	56	55	53										50	49	48		46				39	38	37		35	34	33								73						29			23	22	21			18																	7	6	5	4	3			AVAILABLE	NOT APPLICABLE	34566-3303	G	0	B	ST GR											59	58	57	56	55	53										50	49	48		46				39	38	37		35	34	33								73						29			23	22	21			18																	7	6	5	4	3			AVAILABLE	NOT APPLICABLE	34566-3403	SEE 34566-3003																AVAILABLE	NOT APPLICABLE	34566-3503	G	0	A	BLACK	72	71	70	69	68	67	66	64	63	62	60	59													52		49	48		46		44	43	42	40	39					35	34	33								73						32		29		27		24	23			19	18	17																			9	8	7	6	5	4	3	2	1																																																																																																																					
							73			32	31	30	29	28	27	25	24	23	22	21	20	19	18	17											16	15	14	13	12	11	9	8	7	6	5	4	3	2	1	AVAILABLE	NOT APPLICABLE	34566-3103	G	0	B	ST GR							65		62		59		57		55		53											49	48		46		42		39		37		35		33								73						29		26		23		21				18																	9	8	7			4	3			AVAILABLE	NOT APPLICABLE	34566-3203	G	0	B	ST GR							67				60	59	58	57	56	55	53										50	49	48		46				39	38	37		35	34	33								73						29			23	22	21			18																	7	6	5	4	3			AVAILABLE	NOT APPLICABLE	34566-3303	G	0	B	ST GR											59	58	57	56	55	53										50	49	48		46				39	38	37		35	34	33								73						29			23	22	21			18																	7	6	5	4	3			AVAILABLE	NOT APPLICABLE	34566-3403	SEE 34566-3003																AVAILABLE	NOT APPLICABLE	34566-3503	G	0	A	BLACK	72	71	70	69	68	67	66	64	63	62	60	59													52		49	48		46		44	43	42	40	39					35	34	33								73						32		29		27		24	23			19	18	17																			9	8	7	6	5	4	3	2	1																																																																																																																																															
										16	15	14	13	12	11	9	8	7	6	5	4	3	2	1																																																																																																																																																																																																																																																																																																																																																																																																																																																																																																																																																																																												
AVAILABLE	NOT APPLICABLE	34566-3103	G	0	B	ST GR							65		62		59		57		55		53											49	48		46		42		39		37		35		33								73						29		26		23		21				18																	9	8	7			4	3			AVAILABLE	NOT APPLICABLE	34566-3203	G	0	B	ST GR							67				60	59	58	57	56	55	53										50	49	48		46				39	38	37		35	34	33								73						29			23	22	21			18																	7	6	5	4	3			AVAILABLE	NOT APPLICABLE	34566-3303	G	0	B	ST GR											59	58	57	56	55	53										50	49	48		46				39	38	37		35	34	33								73						29			23	22	21			18																	7	6	5	4	3			AVAILABLE	NOT APPLICABLE	34566-3403	SEE 34566-3003																AVAILABLE	NOT APPLICABLE	34566-3503	G	0	A	BLACK	72	71	70	69	68	67	66	64	63	62	60	59													52		49	48		46		44	43	42	40	39					35	34	33								73						32		29		27		24	23			19	18	17																			9	8	7	6	5	4	3	2	1																																																																																																																																																																																																	
										49	48		46		42		39		37		35		33								73						29		26		23		21				18																	9	8	7			4	3			AVAILABLE	NOT APPLICABLE	34566-3203	G	0	B	ST GR							67				60	59	58	57	56	55	53										50	49	48		46				39	38	37		35	34	33								73						29			23	22	21			18																	7	6	5	4	3			AVAILABLE	NOT APPLICABLE	34566-3303	G	0	B	ST GR											59	58	57	56	55	53										50	49	48		46				39	38	37		35	34	33								73						29			23	22	21			18																	7	6	5	4	3			AVAILABLE	NOT APPLICABLE	34566-3403	SEE 34566-3003																AVAILABLE	NOT APPLICABLE	34566-3503	G	0	A	BLACK	72	71	70	69	68	67	66	64	63	62	60	59													52		49	48		46		44	43	42	40	39					35	34	33								73						32		29		27		24	23			19	18	17																			9	8	7	6	5	4	3	2	1																																																																																																																																																																																																																									
							73						29		26		23		21				18																	9	8	7			4	3			AVAILABLE	NOT APPLICABLE	34566-3203	G	0	B	ST GR							67				60	59	58	57	56	55	53										50	49	48		46				39	38	37		35	34	33								73						29			23	22	21			18																	7	6	5	4	3			AVAILABLE	NOT APPLICABLE	34566-3303	G	0	B	ST GR											59	58	57	56	55	53										50	49	48		46				39	38	37		35	34	33								73						29			23	22	21			18																	7	6	5	4	3			AVAILABLE	NOT APPLICABLE	34566-3403	SEE 34566-3003																AVAILABLE	NOT APPLICABLE	34566-3503	G	0	A	BLACK	72	71	70	69	68	67	66	64	63	62	60	59													52		49	48		46		44	43	42	40	39					35	34	33								73						32		29		27		24	23			19	18	17																			9	8	7	6	5	4	3	2	1																																																																																																																																																																																																																																																	
																9	8	7			4	3																																																																																																																																																																																																																																																																																																																																																																																																																																																																																																																																																																																														
AVAILABLE	NOT APPLICABLE	34566-3203	G	0	B	ST GR							67				60	59	58	57	56	55	53										50	49	48		46				39	38	37		35	34	33								73						29			23	22	21			18																	7	6	5	4	3			AVAILABLE	NOT APPLICABLE	34566-3303	G	0	B	ST GR											59	58	57	56	55	53										50	49	48		46				39	38	37		35	34	33								73						29			23	22	21			18																	7	6	5	4	3			AVAILABLE	NOT APPLICABLE	34566-3403	SEE 34566-3003																AVAILABLE	NOT APPLICABLE	34566-3503	G	0	A	BLACK	72	71	70	69	68	67	66	64	63	62	60	59													52		49	48		46		44	43	42	40	39					35	34	33								73						32		29		27		24	23			19	18	17																			9	8	7	6	5	4	3	2	1																																																																																																																																																																																																																																																																																																		
									50	49	48		46				39	38	37		35	34	33								73						29			23	22	21			18																	7	6	5	4	3			AVAILABLE	NOT APPLICABLE	34566-3303	G	0	B	ST GR											59	58	57	56	55	53										50	49	48		46				39	38	37		35	34	33								73						29			23	22	21			18																	7	6	5	4	3			AVAILABLE	NOT APPLICABLE	34566-3403	SEE 34566-3003																AVAILABLE	NOT APPLICABLE	34566-3503	G	0	A	BLACK	72	71	70	69	68	67	66	64	63	62	60	59													52		49	48		46		44	43	42	40	39					35	34	33								73						32		29		27		24	23			19	18	17																			9	8	7	6	5	4	3	2	1																																																																																																																																																																																																																																																																																																																										
							73						29			23	22	21			18																	7	6	5	4	3			AVAILABLE	NOT APPLICABLE	34566-3303	G	0	B	ST GR											59	58	57	56	55	53										50	49	48		46				39	38	37		35	34	33								73						29			23	22	21			18																	7	6	5	4	3			AVAILABLE	NOT APPLICABLE	34566-3403	SEE 34566-3003																AVAILABLE	NOT APPLICABLE	34566-3503	G	0	A	BLACK	72	71	70	69	68	67	66	64	63	62	60	59													52		49	48		46		44	43	42	40	39					35	34	33								73						32		29		27		24	23			19	18	17																			9	8	7	6	5	4	3	2	1																																																																																																																																																																																																																																																																																																																																																		
																7	6	5	4	3																																																																																																																																																																																																																																																																																																																																																																																																																																																																																																																																																																																																
AVAILABLE	NOT APPLICABLE	34566-3303	G	0	B	ST GR											59	58	57	56	55	53										50	49	48		46				39	38	37		35	34	33								73						29			23	22	21			18																	7	6	5	4	3			AVAILABLE	NOT APPLICABLE	34566-3403	SEE 34566-3003																AVAILABLE	NOT APPLICABLE	34566-3503	G	0	A	BLACK	72	71	70	69	68	67	66	64	63	62	60	59													52		49	48		46		44	43	42	40	39					35	34	33								73						32		29		27		24	23			19	18	17																			9	8	7	6	5	4	3	2	1																																																																																																																																																																																																																																																																																																																																																																																															
									50	49	48		46				39	38	37		35	34	33								73						29			23	22	21			18																	7	6	5	4	3			AVAILABLE	NOT APPLICABLE	34566-3403	SEE 34566-3003																AVAILABLE	NOT APPLICABLE	34566-3503	G	0	A	BLACK	72	71	70	69	68	67	66	64	63	62	60	59													52		49	48		46		44	43	42	40	39					35	34	33								73						32		29		27		24	23			19	18	17																			9	8	7	6	5	4	3	2	1																																																																																																																																																																																																																																																																																																																																																																																																																						
							73						29			23	22	21			18																	7	6	5	4	3			AVAILABLE	NOT APPLICABLE	34566-3403	SEE 34566-3003																AVAILABLE	NOT APPLICABLE	34566-3503	G	0	A	BLACK	72	71	70	69	68	67	66	64	63	62	60	59													52		49	48		46		44	43	42	40	39					35	34	33								73						32		29		27		24	23			19	18	17																			9	8	7	6	5	4	3	2	1																																																																																																																																																																																																																																																																																																																																																																																																																																														
																7	6	5	4	3																																																																																																																																																																																																																																																																																																																																																																																																																																																																																																																																																																																																
AVAILABLE	NOT APPLICABLE	34566-3403	SEE 34566-3003																																																																																																																																																																																																																																																																																																																																																																																																																																																																																																																																																																																																																	
AVAILABLE	NOT APPLICABLE	34566-3503	G	0	A	BLACK	72	71	70	69	68	67	66	64	63	62	60	59													52		49	48		46		44	43	42	40	39					35	34	33								73						32		29		27		24	23			19	18	17																			9	8	7	6	5	4	3	2	1																																																																																																																																																																																																																																																																																																																																																																																																																																																																																																														
							52		49	48		46		44	43	42	40	39					35	34	33								73						32		29		27		24	23			19	18	17																			9	8	7	6	5	4	3	2	1																																																																																																																																																																																																																																																																																																																																																																																																																																																																																																																																						
							73						32		29		27		24	23			19	18	17																			9	8	7	6	5	4	3	2	1																																																																																																																																																																																																																																																																																																																																																																																																																																																																																																																																																																
																		9	8	7	6	5	4	3	2	1																																																																																																																																																																																																																																																																																																																																																																																																																																																																																																																																																																																										

SEE NEXT PAGE FOR ADDITIONAL NUMBERS

<b>ENTER DESCRIPTION</b> EC NO: UAU2010-1551 DRAWN BY: 2010/03/15 CHKDGR: FFH APPR: VKOSHY 2010/03/18 2008/05/09 2010/03/18	QUALITY SYMBOLS	GENERAL TOLERANCES (UNLESS SPECIFIED)	DIMENSION STYLE	SCALE	DESIGN UNITS	THIRD ANGLE PROJECTION	
	▼=0 ▽=0	mm INCH 4 PLACES ±---+--- 3 PLACES ±---+--- 2 PLACES ±---+--- 1 PLACE ±---+---	MM ONLY	1:1	METRIC	DRAWN BY: SRAJENDRANAT DATE: 2008/05/09 CHECKED BY: TSKIVER DATE: 2008/05/09 APPROVED BY: VKOSHY DATE: 2010/03/18	
	DRAFT WHERE APPLICABLE MUST REMAIN WITHIN DIMENSIONS			SEE BOM TABLE		TITLE: MX123 73/80 CKT HRNS CONN ASSY MOLEX INCORPORATED DOCUMENT NO: SD-34566-001 SHEET NO: 6 OF 36	
	THIS DRAWING CONTAINS INFORMATION THAT IS PROPRIETARY TO MOLEX INCORPORATED AND SHOULD NOT BE USED WITHOUT WRITTEN PERMISSION						

19 18 17 16 15 14 13 12 11 10 9 8 7 6 5 4 3 2 1











20 19 18 17 16 15 14 13 12 11 10 9 8 7 6 5 4 3 2 1

STATUS	GM PART #	MATERIAL #	PART/MATERIAL REVISION	WIRE DRESS OPTION	KEY OPTION	COLOR (TPA)	NUMBERS INDICATE CAVITIES OPEN FOR CIRCUITS																																																																																											
AVAILABLE	NOT APPLICABLE	34566-7603	G	0	B	ST GRY	<table border="1"> <tr><td></td><td></td><td>69</td><td>68</td><td>66</td><td></td><td></td><td></td><td></td><td></td><td></td><td></td><td></td><td></td><td>59</td><td>57</td><td>55</td><td>53</td></tr> <tr><td></td><td></td><td>49</td><td>48</td><td>46</td><td></td><td>44</td><td></td><td></td><td></td><td></td><td></td><td></td><td></td><td>39</td><td>37</td><td>35</td><td>33</td></tr> <tr><td colspan="2">73</td><td></td><td></td><td></td><td>29</td><td>28</td><td></td><td></td><td></td><td></td><td></td><td></td><td>23</td><td>21</td><td></td><td>18</td><td>17</td></tr> <tr><td></td><td></td><td></td><td></td><td></td><td></td><td></td><td></td><td>12</td><td>11</td><td>10</td><td></td><td></td><td></td><td>7</td><td></td><td></td><td></td></tr> </table>																		69	68	66										59	57	55	53			49	48	46		44								39	37	35	33	73					29	28							23	21		18	17									12	11	10				7							
		69	68	66										59	57	55	53																																																																																	
		49	48	46		44								39	37	35	33																																																																																	
73					29	28							23	21		18	17																																																																																	
								12	11	10				7																																																																																				
AVAILABLE	NOT APPLICABLE	34566-7703	G	0	A	BLACK	<table border="1"> <tr><td>72</td><td>71</td><td>70</td><td>69</td><td>68</td><td>67</td><td>66</td><td></td><td>64</td><td>63</td><td>62</td><td></td><td>60</td><td>59</td><td></td><td></td><td>55</td><td>54</td><td>53</td></tr> <tr><td>52</td><td></td><td>49</td><td>48</td><td></td><td></td><td></td><td></td><td>44</td><td>43</td><td>42</td><td></td><td>40</td><td>39</td><td></td><td></td><td>35</td><td>34</td><td>33</td></tr> <tr><td colspan="2">73</td><td></td><td>32</td><td></td><td></td><td>29</td><td></td><td>27</td><td></td><td></td><td></td><td>24</td><td>23</td><td></td><td></td><td>19</td><td>18</td><td>17</td></tr> <tr><td></td><td></td><td>16</td><td></td><td></td><td>13</td><td>12</td><td>11</td><td></td><td></td><td>9</td><td>8</td><td>7</td><td>6</td><td>5</td><td>4</td><td>3</td><td>2</td><td>1</td></tr> </table>																72	71	70	69	68	67	66		64	63	62		60	59			55	54	53	52		49	48					44	43	42		40	39			35	34	33	73			32			29		27				24	23			19	18	17			16			13	12	11			9	8	7	6	5	4	3	2	1
72	71	70	69	68	67	66		64	63	62		60	59			55	54	53																																																																																
52		49	48					44	43	42		40	39			35	34	33																																																																																
73			32			29		27				24	23			19	18	17																																																																																
		16			13	12	11			9	8	7	6	5	4	3	2	1																																																																																
AVAILABLE	NOT APPLICABLE	34566-7803	G	0	A	BLACK	<table border="1"> <tr><td>72</td><td>71</td><td>70</td><td></td><td>68</td><td>66</td><td></td><td>64</td><td>63</td><td>62</td><td>61</td><td>60</td><td>59</td><td></td><td></td><td></td><td>55</td><td>54</td><td>53</td></tr> <tr><td>52</td><td></td><td>49</td><td>48</td><td></td><td>46</td><td></td><td>44</td><td>43</td><td>42</td><td></td><td>40</td><td>39</td><td></td><td></td><td></td><td>35</td><td>34</td><td>33</td></tr> <tr><td colspan="2">73</td><td></td><td>32</td><td></td><td></td><td>29</td><td></td><td>27</td><td></td><td></td><td>24</td><td>23</td><td></td><td></td><td></td><td>19</td><td>18</td><td>17</td></tr> <tr><td></td><td></td><td>16</td><td></td><td>14</td><td>13</td><td>12</td><td>11</td><td></td><td></td><td>9</td><td>8</td><td>7</td><td>6</td><td></td><td></td><td>3</td><td>2</td><td>1</td></tr> </table>																72	71	70		68	66		64	63	62	61	60	59				55	54	53	52		49	48		46		44	43	42		40	39				35	34	33	73			32			29		27			24	23				19	18	17			16		14	13	12	11			9	8	7	6			3	2	1
72	71	70		68	66		64	63	62	61	60	59				55	54	53																																																																																
52		49	48		46		44	43	42		40	39				35	34	33																																																																																
73			32			29		27			24	23				19	18	17																																																																																
		16		14	13	12	11			9	8	7	6			3	2	1																																																																																
AVAILABLE	NOT APPLICABLE	34566-7903	G	0	B	ST GRY	<table border="1"> <tr><td></td><td></td><td></td><td></td><td></td><td></td><td></td><td></td><td>64</td><td></td><td>61</td><td>59</td><td>57</td><td>55</td><td>53</td><td></td><td></td><td></td><td></td></tr> <tr><td></td><td></td><td></td><td></td><td></td><td></td><td></td><td></td><td></td><td></td><td>42</td><td></td><td>39</td><td></td><td>35</td><td>33</td><td></td><td></td><td></td></tr> <tr><td colspan="2">73</td><td></td><td></td><td></td><td></td><td></td><td></td><td></td><td></td><td></td><td></td><td>23</td><td></td><td>20</td><td>19</td><td>18</td><td>17</td><td></td></tr> <tr><td></td><td></td><td></td><td></td><td></td><td>15</td><td></td><td></td><td></td><td></td><td></td><td></td><td></td><td></td><td>4</td><td>3</td><td>2</td><td>1</td><td></td></tr> </table>																								64		61	59	57	55	53															42		39		35	33				73												23		20	19	18	17							15									4	3	2	1	
								64		61	59	57	55	53																																																																																				
										42		39		35	33																																																																																			
73												23		20	19	18	17																																																																																	
					15									4	3	2	1																																																																																	
AVAILABLE	NOT APPLICABLE	34566-8003	G	0	A	BLACK	<table border="1"> <tr><td></td><td></td><td>69</td><td>68</td><td></td><td></td><td>65</td><td>64</td><td>63</td><td></td><td>61</td><td>60</td><td>59</td><td>58</td><td>56</td><td></td><td></td><td></td><td></td></tr> <tr><td>52</td><td>50</td><td>49</td><td>48</td><td>47</td><td></td><td></td><td></td><td></td><td></td><td>41</td><td></td><td></td><td>38</td><td>37</td><td>36</td><td>34</td><td>33</td><td></td></tr> <tr><td colspan="2">73</td><td></td><td>32</td><td>31</td><td>30</td><td>29</td><td>28</td><td>27</td><td></td><td></td><td>24</td><td>23</td><td></td><td></td><td>20</td><td>19</td><td>18</td><td>17</td></tr> <tr><td></td><td></td><td>16</td><td></td><td></td><td></td><td>13</td><td>12</td><td>11</td><td>10</td><td>9</td><td></td><td></td><td></td><td></td><td></td><td></td><td></td><td>1</td></tr> </table>																		69	68			65	64	63		61	60	59	58	56					52	50	49	48	47						41			38	37	36	34	33		73			32	31	30	29	28	27			24	23			20	19	18	17			16				13	12	11	10	9								1
		69	68			65	64	63		61	60	59	58	56																																																																																				
52	50	49	48	47						41			38	37	36	34	33																																																																																	
73			32	31	30	29	28	27			24	23			20	19	18	17																																																																																
		16				13	12	11	10	9								1																																																																																
AVAILABLE	NOT APPLICABLE	34566-8103	G	0	H	ST GRY	<table border="1"> <tr><td></td><td>78</td><td></td><td></td><td></td><td></td><td></td><td>72</td><td>71</td><td>70</td><td>69</td><td>68</td><td></td><td>66</td><td>65</td><td>64</td><td>63</td><td>61</td><td></td></tr> <tr><td>60</td><td>59</td><td>58</td><td>57</td><td>56</td><td></td><td></td><td>53</td><td>52</td><td>50</td><td></td><td></td><td></td><td></td><td></td><td>44</td><td>43</td><td>41</td><td></td></tr> <tr><td>40</td><td></td><td>37</td><td></td><td>35</td><td>34</td><td>33</td><td>32</td><td></td><td>30</td><td>29</td><td></td><td>27</td><td>26</td><td>24</td><td></td><td>22</td><td>21</td><td></td></tr> <tr><td>20</td><td>19</td><td>18</td><td>17</td><td>16</td><td></td><td></td><td>13</td><td>12</td><td></td><td></td><td>8</td><td>6</td><td>5</td><td></td><td>3</td><td>2</td><td></td><td></td></tr> </table>																	78						72	71	70	69	68		66	65	64	63	61		60	59	58	57	56			53	52	50						44	43	41		40		37		35	34	33	32		30	29		27	26	24		22	21		20	19	18	17	16			13	12			8	6	5		3	2		
	78						72	71	70	69	68		66	65	64	63	61																																																																																	
60	59	58	57	56			53	52	50						44	43	41																																																																																	
40		37		35	34	33	32		30	29		27	26	24		22	21																																																																																	
20	19	18	17	16			13	12			8	6	5		3	2																																																																																		
AVAILABLE	NOT APPLICABLE	34566-8203	G	0	A	BLACK	<table border="1"> <tr><td></td><td>70</td><td></td><td>67</td><td>66</td><td></td><td></td><td></td><td></td><td></td><td></td><td></td><td>58</td><td>56</td><td>55</td><td>54</td><td></td><td></td><td></td></tr> <tr><td></td><td></td><td></td><td>47</td><td></td><td></td><td>44</td><td>43</td><td>42</td><td>41</td><td></td><td>39</td><td></td><td>37</td><td>36</td><td>34</td><td></td><td></td><td></td></tr> <tr><td colspan="2">73</td><td></td><td>31</td><td>30</td><td></td><td></td><td></td><td>27</td><td>25</td><td>24</td><td></td><td></td><td>21</td><td>20</td><td>19</td><td>18</td><td></td><td></td></tr> <tr><td></td><td></td><td></td><td></td><td></td><td></td><td>13</td><td></td><td></td><td></td><td></td><td></td><td></td><td>6</td><td>5</td><td>4</td><td>3</td><td>2</td><td>1</td></tr> </table>																	70		67	66								58	56	55	54							47			44	43	42	41		39		37	36	34				73			31	30				27	25	24			21	20	19	18									13							6	5	4	3	2	1
	70		67	66								58	56	55	54																																																																																			
			47			44	43	42	41		39		37	36	34																																																																																			
73			31	30				27	25	24			21	20	19	18																																																																																		
						13							6	5	4	3	2	1																																																																																
AVAILABLE	NOT APPLICABLE	34566-8303	G	0	A	BLACK	<table border="1"> <tr><td>72</td><td>71</td><td>69</td><td>68</td><td>67</td><td>66</td><td></td><td>64</td><td>63</td><td>62</td><td></td><td>59</td><td>58</td><td>57</td><td>56</td><td></td><td>54</td><td>53</td></tr> <tr><td>52</td><td>51</td><td>50</td><td>49</td><td>48</td><td>47</td><td>46</td><td></td><td>44</td><td>43</td><td>42</td><td></td><td>39</td><td>38</td><td>37</td><td>36</td><td>35</td><td>34</td><td>33</td></tr> <tr><td colspan="2">73</td><td></td><td>32</td><td>31</td><td>30</td><td>29</td><td></td><td>27</td><td></td><td></td><td>24</td><td>23</td><td>22</td><td>21</td><td>20</td><td>19</td><td>18</td><td>17</td></tr> <tr><td></td><td></td><td></td><td>15</td><td>14</td><td>13</td><td>12</td><td>11</td><td></td><td></td><td>9</td><td>8</td><td>7</td><td>6</td><td>5</td><td>4</td><td>3</td><td>2</td><td>1</td></tr> </table>																72	71	69	68	67	66		64	63	62		59	58	57	56		54	53	52	51	50	49	48	47	46		44	43	42		39	38	37	36	35	34	33	73			32	31	30	29		27			24	23	22	21	20	19	18	17				15	14	13	12	11			9	8	7	6	5	4	3	2	1	
72	71	69	68	67	66		64	63	62		59	58	57	56		54	53																																																																																	
52	51	50	49	48	47	46		44	43	42		39	38	37	36	35	34	33																																																																																
73			32	31	30	29		27			24	23	22	21	20	19	18	17																																																																																
			15	14	13	12	11			9	8	7	6	5	4	3	2	1																																																																																

SEE NEXT PAGE FOR ADDITIONAL NUMBERS

<b>ENTER DESCRIPTION</b> EC NO: UAU2010-1551 DRAWN BY: DRWNAH01 CHECKED BY: CHKDGRFFHS APPROVED BY: APPR.VKOSHY DATE: 2010/03/15 DATE: 2008/05/09 DATE: 2010/03/18 <b>F40</b>	<b>QUALITY SYMBOLS</b> ▽=0 ▽=0	<b>GENERAL TOLERANCES (UNLESS SPECIFIED)</b> <table border="1"> <tr><th></th><th>mm</th><th>INCH</th></tr> <tr><td>4 PLACES ±</td><td>---</td><td>---</td></tr> <tr><td>3 PLACES ±</td><td>---</td><td>---</td></tr> <tr><td>2 PLACES ±</td><td>---</td><td>---</td></tr> <tr><td>1 PLACE ±</td><td>---</td><td>---</td></tr> </table>		mm	INCH	4 PLACES ±	---	---	3 PLACES ±	---	---	2 PLACES ±	---	---	1 PLACE ±	---	---	<b>DIMENSION STYLE</b> <b>MM ONLY</b>	<b>SCALE</b> <b>1:1</b>	<b>DESIGN UNITS</b> <b>METRIC</b>	<b>THIRD ANGLE PROJECTION</b>
		mm	INCH																		
	4 PLACES ±	---	---																		
	3 PLACES ±	---	---																		
2 PLACES ±	---	---																			
1 PLACE ±	---	---																			
<b>DRAFT WHERE APPLICABLE MUST REMAIN WITHIN DIMENSIONS</b>	<b>SEE BOM TABLE</b>	<b>MATERIAL NO.</b> SD-34566-001	<b>DOCUMENT NO.</b> SD-34566-001	<b>SHEET NO.</b> 12 OF 36	<b>TITLE</b> MX123 73/80 CKT HRNS CONN ASSY																
<b>MOLEX INCORPORATED</b>																					
THIS DRAWING CONTAINS INFORMATION THAT IS PROPRIETARY TO MOLEX INCORPORATED AND SHOULD NOT BE USED WITHOUT WRITTEN PERMISSION																					

19 18 17 16 15 14 13 12 11 10 9 8 7 6 5 4 3 2 1









20 19 18 17 16 15 14 13 12 11 10 9 8 7 6 5 4 3 2 1

STATUS	GM PART #	MATERIAL #	PART/MATERIAL REVISION	WIRE DRESS OPTION	KEY OPTION	COLOR (TPA)	NUMBERS INDICATE CAVITIES OPEN FOR CIRCUITS																
AVAILABLE	NOT APPLICABLE	34566-1193	G	0	A	BLACK	72	71	69	68	67	66	64	63	62	60	59					54	53
							52		49	48	46	44	43	42		39					34	33	
							73		32		29	27			23						17		
										14	13	12	11		9	8	7	6	5	4	3	2	1
AVAILABLE	NOT APPLICABLE	34566-1213	G	0	A	BLACK	72	71	69	68	67	66	64	63	62		59				54	53	
							52		48	46	44	43	42		39						34	33	
							73		32		29	27			24	23					17		
										14	13	12	11		9	8			5	4	3	2	1
AVAILABLE	NOT APPLICABLE	34566-1223	G	0	B	ST GRY				67	66	65	63	62		59	57	55		53			
									48			43	42		39	37	35		33				
							73				29	27	26		23	21					17		
											12			9	7								
AVAILABLE	NOT APPLICABLE	34566-1233	G	0	B	ST GRY				48	46		65	62		59	57	55		53			
													42		39	37	35		33				
							73				29	26			23	21					17		
												12		9	7								
AVAILABLE	NOT APPLICABLE	34566-1243	G	0	B	ST GRY			50	48	46					59	57	55		53			
															40	39	37	35		33			
							73				29				23	21					17		
										15		12			7	6	5	4	3				
AVAILABLE	NOT APPLICABLE	34566-1253	G	9	B	ST GRY			49	48		65			60	59	57	55		53			
											46				40	39	37	35		33			
							73								24	23	21				2		
AVAILABLE	NOT APPLICABLE	34566-1263	G	9	A	BLACK	72	71	69	68	67	66	64	63	62		59		56		53		
							50		48	46	44	43	42		39		36	35		33			
							73		32	30	29	27			24	23					17		
										14	13	12	11		9	8			5	4	3	2	1
AVAILABLE	NOT APPLICABLE	34566-1273	G	0	A	BLACK		70	69	68		65	64	63		61	59	58	57	56			
							52	50	49	48	47				41		38	37	36		34	33	
							73		32	31	30	29	28	27		24	23			20	19	18	
									16			13	12	11	10	9						1	

<b>ENTER DESCRIPTION</b> EC NO: UAU2010-1551 DRAWN BY: 2010/03/15 CHECKED BY: 2008/05/09 APPROVED BY: 2010/03/18 T40	<b>QUALITY SYMBOLS</b> ▽=0 ▽=0	<b>GENERAL TOLERANCES (UNLESS SPECIFIED)</b> <table border="1"> <tr> <th></th> <th>mm</th> <th>INCH</th> </tr> <tr> <td>4 PLACES</td> <td>±---</td> <td>±---</td> </tr> <tr> <td>3 PLACES</td> <td>±---</td> <td>±---</td> </tr> <tr> <td>2 PLACES</td> <td>±---</td> <td>±---</td> </tr> <tr> <td>1 PLACE</td> <td>±---</td> <td>±---</td> </tr> </table>		mm	INCH	4 PLACES	±---	±---	3 PLACES	±---	±---	2 PLACES	±---	±---	1 PLACE	±---	±---	<b>DIMENSION STYLE</b> <b>MM ONLY</b>	<b>SCALE</b> <b>1:1</b>	<b>DESIGN UNITS</b> <b>METRIC</b>	<b>THIRD ANGLE PROJECTION</b>
		mm	INCH																		
	4 PLACES	±---	±---																		
	3 PLACES	±---	±---																		
2 PLACES	±---	±---																			
1 PLACE	±---	±---																			
<b>DESCRIPTION</b> MXT23 73/80 CKT HRNS CONN ASSY	<b>DRAWN BY</b> SRAJENDRANAT	<b>DATE</b> 2008/05/09	<b>TITLE</b> MXT23 73/80 CKT HRNS CONN ASSY	<b>APPROVED BY</b> VKOSHY	<b>DATE</b> 2010/03/18	<b>MATERIAL NO.</b> SD-34566-001															
<b>DRAFT WHERE APPLICABLE MUST REMAIN WITHIN DIMENSIONS</b>	<b>SEE BOM TABLE</b>	<b>MOLEX INCORPORATED</b>	<b>MOLEX INCORPORATED</b>	<b>DOCUMENT NO.</b> SD-34566-001	<b>SHEET NO.</b> 17 OF 36	<b>THIS DRAWING CONTAINS INFORMATION THAT IS PROPRIETARY TO MOLEX INCORPORATED AND SHOULD NOT BE USED WITHOUT WRITTEN PERMISSION</b>															

19 18 17 16 15 14 13 12 11 10 9 8 7 6 5 4 3 2 1

20 19 18 17 16 15 14 13 12 11 10 9 8 7 6 5 4 3 2 1

STATUS	GM PART #	MATERIAL #	PART/MATERIAL REVISION	WIRE DRESS OPTION	KEY OPTION	COLOR (TPA)	NUMBERS INDICATE CAVITIES OPEN FOR CIRCUITS																																																																														
AVAILABLE	NOT APPLICABLE	34566-1283	G	0	A	BLACK	<table border="1"> <tr><td>72</td><td>71</td><td>70</td><td>69</td><td>68</td><td>66</td><td>65</td><td>64</td><td>63</td><td>61</td><td>59</td><td>58</td><td>57</td><td>56</td><td>54</td></tr> <tr><td>52</td><td>50</td><td>49</td><td>48</td><td>47</td><td></td><td></td><td></td><td></td><td>42</td><td>41</td><td></td><td>38</td><td>37</td><td>36</td><td>34</td><td>33</td></tr> <tr><td colspan="4">73</td><td>32</td><td>31</td><td>30</td><td>29</td><td>28</td><td>27</td><td>26</td><td>24</td><td>23</td><td></td><td>20</td><td>19</td><td>18</td></tr> <tr><td colspan="4"></td><td>16</td><td></td><td></td><td>13</td><td>12</td><td>11</td><td>10</td><td>9</td><td></td><td></td><td></td><td></td><td></td></tr> </table>	72	71	70	69	68	66	65	64	63	61	59	58	57	56	54	52	50	49	48	47					42	41		38	37	36	34	33	73				32	31	30	29	28	27	26	24	23		20	19	18					16			13	12	11	10	9																	
72	71	70	69	68	66	65	64	63	61	59	58	57	56	54																																																																							
52	50	49	48	47					42	41		38	37	36	34	33																																																																					
73				32	31	30	29	28	27	26	24	23		20	19	18																																																																					
				16			13	12	11	10	9																																																																										
AVAILABLE	NOT APPLICABLE	34566-1293	G	0	A	BLACK	<table border="1"> <tr><td></td><td></td><td></td><td>68</td><td></td><td>65</td><td>64</td><td>63</td><td>61</td><td>59</td><td>58</td><td>56</td><td></td><td></td><td></td><td></td><td></td></tr> <tr><td>52</td><td>50</td><td></td><td>47</td><td></td><td></td><td></td><td></td><td>41</td><td></td><td>38</td><td>37</td><td>36</td><td>34</td><td>33</td><td></td><td></td></tr> <tr><td colspan="3">73</td><td>32</td><td>31</td><td>30</td><td>29</td><td>28</td><td>27</td><td>26</td><td>24</td><td>23</td><td></td><td>20</td><td>19</td><td>18</td><td>17</td></tr> <tr><td colspan="3"></td><td>16</td><td></td><td></td><td>13</td><td>12</td><td>11</td><td>10</td><td>9</td><td></td><td></td><td></td><td></td><td></td><td>1</td></tr> </table>				68		65	64	63	61	59	58	56						52	50		47					41		38	37	36	34	33			73			32	31	30	29	28	27	26	24	23		20	19	18	17				16			13	12	11	10	9						1										
			68		65	64	63	61	59	58	56																																																																										
52	50		47					41		38	37	36	34	33																																																																							
73			32	31	30	29	28	27	26	24	23		20	19	18	17																																																																					
			16			13	12	11	10	9						1																																																																					
AVAILABLE	NOT APPLICABLE	34566-1313	G	0	H	ST GRY	<table border="1"> <tr><td>80</td><td>78</td><td></td><td></td><td></td><td></td><td></td><td>72</td><td>71</td><td>70</td><td>69</td><td>68</td><td>66</td><td>65</td><td>64</td><td>63</td><td>61</td></tr> <tr><td></td><td>58</td><td>57</td><td>56</td><td>55</td><td>54</td><td>53</td><td></td><td></td><td></td><td></td><td></td><td>46</td><td></td><td>44</td><td>43</td><td>42</td></tr> <tr><td>40</td><td></td><td>37</td><td></td><td>35</td><td></td><td></td><td>32</td><td>30</td><td>29</td><td></td><td>27</td><td>26</td><td></td><td></td><td></td><td>21</td></tr> <tr><td>20</td><td>19</td><td>18</td><td>17</td><td></td><td>15</td><td></td><td>12</td><td></td><td></td><td>8</td><td>6</td><td>5</td><td></td><td>3</td><td>2</td><td></td></tr> </table>	80	78						72	71	70	69	68	66	65	64	63	61		58	57	56	55	54	53						46		44	43	42	40		37		35			32	30	29		27	26				21	20	19	18	17		15		12			8	6	5		3	2											
80	78						72	71	70	69	68	66	65	64	63	61																																																																					
	58	57	56	55	54	53						46		44	43	42																																																																					
40		37		35			32	30	29		27	26				21																																																																					
20	19	18	17		15		12			8	6	5		3	2																																																																						
AVAILABLE	NOT APPLICABLE	34566-1323	G	0	A	BLACK	<table border="1"> <tr><td>72</td><td>71</td><td>70</td><td>69</td><td>68</td><td>67</td><td>66</td><td>65</td><td>64</td><td>63</td><td>62</td><td>60</td><td>59</td><td>58</td><td>57</td><td>56</td><td>55</td><td>54</td><td>53</td></tr> <tr><td>52</td><td>51</td><td>50</td><td>49</td><td>48</td><td>47</td><td>46</td><td>45</td><td>44</td><td>43</td><td>42</td><td>41</td><td>40</td><td>39</td><td>38</td><td>37</td><td>36</td><td>35</td><td>34</td><td>33</td></tr> <tr><td colspan="4">73</td><td>32</td><td>31</td><td>30</td><td>29</td><td>28</td><td>27</td><td>25</td><td>24</td><td>23</td><td>22</td><td>21</td><td>20</td><td>19</td><td>18</td><td>17</td></tr> <tr><td colspan="4"></td><td>16</td><td>15</td><td>14</td><td>13</td><td>12</td><td>11</td><td></td><td>9</td><td>8</td><td>7</td><td>6</td><td>5</td><td>4</td><td>3</td><td>2</td><td>1</td></tr> </table>	72	71	70	69	68	67	66	65	64	63	62	60	59	58	57	56	55	54	53	52	51	50	49	48	47	46	45	44	43	42	41	40	39	38	37	36	35	34	33	73				32	31	30	29	28	27	25	24	23	22	21	20	19	18	17					16	15	14	13	12	11		9	8	7	6	5	4	3	2	1
72	71	70	69	68	67	66	65	64	63	62	60	59	58	57	56	55	54	53																																																																			
52	51	50	49	48	47	46	45	44	43	42	41	40	39	38	37	36	35	34	33																																																																		
73				32	31	30	29	28	27	25	24	23	22	21	20	19	18	17																																																																			
				16	15	14	13	12	11		9	8	7	6	5	4	3	2	1																																																																		
AVAILABLE	NOT APPLICABLE	34566-1333	G	0	A	BLACK	<table border="1"> <tr><td></td><td>70</td><td>69</td><td>68</td><td></td><td>65</td><td>64</td><td></td><td></td><td></td><td>59</td><td>58</td><td>56</td><td></td><td></td><td></td><td></td><td></td></tr> <tr><td>52</td><td>50</td><td>49</td><td>47</td><td></td><td></td><td></td><td></td><td></td><td>41</td><td></td><td>38</td><td>37</td><td>36</td><td>34</td><td></td><td></td><td></td><td></td></tr> <tr><td colspan="3">73</td><td>32</td><td>31</td><td>30</td><td>29</td><td>28</td><td>27</td><td></td><td></td><td>23</td><td></td><td>20</td><td>19</td><td>18</td><td>17</td><td></td><td></td></tr> <tr><td colspan="3"></td><td>16</td><td></td><td></td><td>13</td><td>12</td><td>11</td><td>10</td><td>9</td><td>8</td><td>6</td><td></td><td></td><td></td><td></td><td></td><td>1</td></tr> </table>		70	69	68		65	64				59	58	56						52	50	49	47						41		38	37	36	34					73			32	31	30	29	28	27			23		20	19	18	17						16			13	12	11	10	9	8	6						1			
	70	69	68		65	64				59	58	56																																																																									
52	50	49	47						41		38	37	36	34																																																																							
73			32	31	30	29	28	27			23		20	19	18	17																																																																					
			16			13	12	11	10	9	8	6						1																																																																			
AVAILABLE	NOT APPLICABLE	34566-1343	G	0	A	BLACK	<table border="1"> <tr><td>72</td><td>71</td><td></td><td>69</td><td>67</td><td>65</td><td>64</td><td>63</td><td></td><td></td><td>59</td><td>58</td><td>57</td><td>56</td><td></td><td></td><td></td><td></td><td></td></tr> <tr><td></td><td>50</td><td>49</td><td>48</td><td>47</td><td></td><td></td><td></td><td></td><td>41</td><td></td><td>38</td><td>37</td><td>36</td><td>34</td><td></td><td></td><td></td><td></td></tr> <tr><td colspan="3">73</td><td>32</td><td>31</td><td>30</td><td>29</td><td>28</td><td>27</td><td></td><td></td><td>23</td><td></td><td>20</td><td>19</td><td>18</td><td>17</td><td></td><td></td></tr> <tr><td colspan="3"></td><td>16</td><td></td><td></td><td>13</td><td>12</td><td>11</td><td>10</td><td>9</td><td>7</td><td>6</td><td>4</td><td>3</td><td>2</td><td>1</td><td></td><td></td></tr> </table>	72	71		69	67	65	64	63			59	58	57	56							50	49	48	47					41		38	37	36	34					73			32	31	30	29	28	27			23		20	19	18	17						16			13	12	11	10	9	7	6	4	3	2	1				
72	71		69	67	65	64	63			59	58	57	56																																																																								
	50	49	48	47					41		38	37	36	34																																																																							
73			32	31	30	29	28	27			23		20	19	18	17																																																																					
			16			13	12	11	10	9	7	6	4	3	2	1																																																																					
AVAILABLE	NOT APPLICABLE	34566-1353	G	0	H	ST GRY	<table border="1"> <tr><td>79</td><td>78</td><td>77</td><td>76</td><td>75</td><td>74</td><td>73</td><td>72</td><td>71</td><td>70</td><td>69</td><td>68</td><td>66</td><td>65</td><td>64</td><td>63</td><td>61</td></tr> <tr><td>60</td><td>59</td><td>58</td><td>57</td><td>56</td><td></td><td>53</td><td></td><td>50</td><td></td><td></td><td></td><td></td><td></td><td>44</td><td>43</td><td>41</td></tr> <tr><td>40</td><td>39</td><td>38</td><td>37</td><td></td><td>35</td><td>34</td><td>32</td><td>30</td><td>29</td><td></td><td>27</td><td>26</td><td></td><td></td><td></td><td>22</td><td>21</td></tr> <tr><td>20</td><td>19</td><td>18</td><td>17</td><td></td><td></td><td>13</td><td>12</td><td>11</td><td></td><td>8</td><td>6</td><td>5</td><td></td><td>3</td><td>2</td><td></td><td></td></tr> </table>	79	78	77	76	75	74	73	72	71	70	69	68	66	65	64	63	61	60	59	58	57	56		53		50						44	43	41	40	39	38	37		35	34	32	30	29		27	26				22	21	20	19	18	17			13	12	11		8	6	5		3	2										
79	78	77	76	75	74	73	72	71	70	69	68	66	65	64	63	61																																																																					
60	59	58	57	56		53		50						44	43	41																																																																					
40	39	38	37		35	34	32	30	29		27	26				22	21																																																																				
20	19	18	17			13	12	11		8	6	5		3	2																																																																						
AVAILABLE	NOT APPLICABLE	34566-1363	G	0	A	BLACK	<table border="1"> <tr><td>72</td><td>71</td><td></td><td>69</td><td>68</td><td>67</td><td>66</td><td>64</td><td>63</td><td>62</td><td></td><td>59</td><td></td><td></td><td></td><td></td><td></td><td></td><td>53</td></tr> <tr><td></td><td></td><td></td><td>48</td><td>46</td><td></td><td></td><td>44</td><td>43</td><td>42</td><td></td><td>39</td><td></td><td></td><td></td><td></td><td></td><td></td><td>33</td></tr> <tr><td colspan="3">73</td><td>32</td><td></td><td>29</td><td>27</td><td></td><td></td><td>24</td><td>23</td><td></td><td></td><td></td><td></td><td></td><td></td><td></td><td>17</td></tr> <tr><td colspan="3"></td><td></td><td></td><td>14</td><td>13</td><td>12</td><td>11</td><td></td><td>9</td><td>8</td><td></td><td></td><td>5</td><td>4</td><td>3</td><td>2</td><td>1</td></tr> </table>	72	71		69	68	67	66	64	63	62		59							53				48	46			44	43	42		39							33	73			32		29	27			24	23								17						14	13	12	11		9	8			5	4	3	2	1		
72	71		69	68	67	66	64	63	62		59							53																																																																			
			48	46			44	43	42		39							33																																																																			
73			32		29	27			24	23								17																																																																			
					14	13	12	11		9	8			5	4	3	2	1																																																																			

<b>ENTER DESCRIPTION</b> EC NO: UAU2010-1551 DRAWN BY: 2010/03/15 CHKDGR: FFH 2008/05/09 APPR: VKOSHY 2010/03/18 REV: T40	<b>QUALITY SYMBOLS</b> ▽=0 ▽=0	<b>GENERAL TOLERANCES (UNLESS SPECIFIED)</b> <table border="1"> <tr><th></th><th>mm</th><th>INCH</th></tr> <tr><td>4 PLACES</td><td>±---</td><td>±---</td></tr> <tr><td>3 PLACES</td><td>±---</td><td>±---</td></tr> <tr><td>2 PLACES</td><td>±---</td><td>±---</td></tr> <tr><td>1 PLACE</td><td>±---</td><td>±---</td></tr> </table>		mm	INCH	4 PLACES	±---	±---	3 PLACES	±---	±---	2 PLACES	±---	±---	1 PLACE	±---	±---	<b>DIMENSION STYLE</b> <b>MM ONLY</b>	<b>SCALE</b> <b>1:1</b>	<b>DESIGN UNITS</b> <b>METRIC</b>	<b>THIRD ANGLE PROJECTION</b>
		mm	INCH																		
	4 PLACES	±---	±---																		
	3 PLACES	±---	±---																		
2 PLACES	±---	±---																			
1 PLACE	±---	±---																			
<b>DRAFT WHERE APPLICABLE MUST REMAIN WITHIN DIMENSIONS</b>	<b>SEE BOM TABLE</b>	<b>MATERIAL NO.</b> SD-34566-001	<b>SCALE</b> <b>1:1</b>	<b>DESIGN UNITS</b> <b>METRIC</b>	<b>THIRD ANGLE PROJECTION</b>	<b>DOCUMENT NO.</b> MX123 73/80 CKT HRNS CONN ASSY															
<b>SIZE D</b>	<b>THIS DRAWING CONTAINS INFORMATION THAT IS PROPRIETARY TO MOLEX INCORPORATED AND SHOULD NOT BE USED WITHOUT WRITTEN PERMISSION</b>	<b>SHEET NO.</b> 18 OF 36	<b>DATE</b> 2008/05/09	<b>DATE</b> 2008/05/09	<b>DATE</b> 2010/03/18	<b>MOLEX INCORPORATED</b>															
<b>APPROVED BY</b> VKOSHY	<b>DATE</b> 2010/03/18	<b>MOLEX INCORPORATED</b>	<b>DATE</b> 2008/05/09	<b>DATE</b> 2008/05/09	<b>DATE</b> 2010/03/18	<b>MOLEX INCORPORATED</b>															

19 18 17 16 15 14 13 12 11 10 9 8 7 6 5 4 3 2 1



20 19 18 17 16 15 14 13 12 11 10 9 8 7 6 5 4 3 2 1

STATUS	GM PART #	MATERIAL #	PART/MATERIAL REVISION	WIRE DRESS OPTION	KEY OPTION	COLOR (TPA)	NUMBERS INDICATE CAVITIES OPEN FOR CIRCUITS																					
AVAILABLE	NOT APPLICABLE	34566-1473	G	0	A	BLACK	72	71	69	68	67	66	64	63	62	59										54	53	
							52		49	48	46	44	43	42	39											34	33	
										32		29	27		24	23										17		
												14	13	12	11	9	8	7	6	5	4	3	2	1				
AVAILABLE	NOT APPLICABLE	34566-1483	G	0	A	BLACK	72	71	69	68		65	64	63	61	59	58		56						34	33		
							52	50	49		47				41		38	37	36						20	19	18	17
																24	23										1	
AVAILABLE	NOT APPLICABLE	34566-1493	G	0	B	ST GRY				68						59	58	57		55						53		
										49	48	46					39	38	37		35					33		
																	23	22	21							18	17	
																											1	
AVAILABLE	NOT APPLICABLE	34566-1513	G	0	B	ST GRY										59		57		55						53		
									49	48	46						39		37		35					33		
																	23		21							17		
AVAILABLE	NOT APPLICABLE	34566-1523	G	0	A	BLACK		70	69	68		65	64			59	58		56		54							
							52	50	49		47				42	41		38	37	36		34						
																	23											
AVAILABLE	NOT APPLICABLE	34566-1533	G	0	A	BLACK	72	71	70	69	68		65	64	63	61	59	58	57	56								
							52	51	50	49		47				41		38	37	36		34				33		
																	24	23								17		
AVAILABLE	NOT APPLICABLE	34566-1543	G	0	B	ST GRY				69	68	66					59		57		55							
										49	48	46					39		37		35					33		
																	23		21									
AVAILABLE	NOT APPLICABLE	34566-1583	G	0	A	BLACK		70		67	66	65				61		58	57		55	54						
									49		47	45	44	43	42	41	39		37		34							

<b>ENTER DESCRIPTION</b> EC NO: UAU2010-1551 DRAWN BY: DRWN:AM01 CHECKED BY: CHKD:GRFF:HS APPROVED BY: APPR:VKOSHY DATE: 2010/03/15 DATE: 2008/05/09 DATE: 2010/03/18 REV: F40	<b>QUALITY SYMBOLS</b> ▽=0 ▽=0	<b>GENERAL TOLERANCES (UNLESS SPECIFIED)</b> <table border="1"> <tr> <th></th> <th>mm</th> <th>INCH</th> </tr> <tr> <td>4 PLACES ±</td> <td>---</td> <td>---</td> </tr> <tr> <td>3 PLACES ±</td> <td>---</td> <td>---</td> </tr> <tr> <td>2 PLACES ±</td> <td>---</td> <td>---</td> </tr> <tr> <td>1 PLACE ±</td> <td>---</td> <td>---</td> </tr> </table>		mm	INCH	4 PLACES ±	---	---	3 PLACES ±	---	---	2 PLACES ±	---	---	1 PLACE ±	---	---	<b>DIMENSION STYLE</b> <b>MM ONLY</b>	<b>SCALE</b> <b>1:1</b>	<b>DESIGN UNITS</b> <b>METRIC</b>	<b>THIRD ANGLE PROJECTION</b>
		mm	INCH																		
	4 PLACES ±	---	---																		
	3 PLACES ±	---	---																		
2 PLACES ±	---	---																			
1 PLACE ±	---	---																			
		<b>DRAFT WHERE APPLICABLE MUST REMAIN WITHIN DIMENSIONS</b>	<b>DRAWN BY</b> SRAJENDRANAT <b>CHECKED BY</b> TSKIVER <b>APPROVED BY</b> VKOSHY <b>DATE</b> 2008/05/09 <b>DATE</b> 2010/03/18	<b>DATE</b> 2008/05/09 <b>DATE</b> 2010/03/18	<b>TITLE</b> <b>MX123</b> <b>73/80 CKT</b> <b>HRNS CONN ASSY</b>	<b>MOLEX INCORPORATED</b>															
			<b>SEE BOM TABLE</b>	<b>DOCUMENT NO.</b> SD-34566-001	<b>SHEET NO.</b> 20 OF 36	<b>THIS DRAWING CONTAINS INFORMATION THAT IS PROPRIETARY TO MOLEX INCORPORATED AND SHOULD NOT BE USED WITHOUT WRITTEN PERMISSION</b>															

19 18 17 16 15 14 13 12 11 10 9 8 7 6 5 4 3 2 1





20 19 18 17 16 15 14 13 12 11 10 9 8 7 6 5 4 3 2 1

STATUS	GM PART #	MATERIAL #	PART / MATERIAL REVISION	WIRE DRESS OPTION	KEY OPTION	COLOR (TPA)	NUMBERS INDICATE CAVITIES OPEN FOR CIRCUITS																		
AVAILABLE	NOT APPLICABLE	34566-1773	G	0	C	BLUE	72	70		67	66		63	62		59	57					53			
							52	51			46	44		42	40	39						34	33		
							73				30			27	26	25		22	21	20					
										15	14			10	9		6	5	4						
AVAILABLE	NOT APPLICABLE	34566-1783	G	0	C	BLUE	72	70		67	66		63	62		59	57					53			
							52	51			46	44		42	40	39						34	33		
							73				30			26	25		22	21	20						
										15	14			10	9		6	5	4						
AVAILABLE	NOT APPLICABLE	34566-1793	G	0	A	BLACK			69				63	62	61		58	57	56	55	54	53			
							52	51	49				44	43	42	41			37	36	35	34	33		
							73				32		29	28	27	26					19	18			
										16		13	12	11	10						3				
AVAILABLE	NOT APPLICABLE	34566-1813	G	0	B	ST GRAY	72	71	70	68	67	66		62	61	60	59	58	57	56	55	54	53		
							52	51	50	48	47	46		42	41	40	39	38	37	36	35	34	33		
							73				32	31	30	29	28	27	26	25	24	23					
										16	15	14	13		10	9	8								
AVAILABLE	NOT APPLICABLE	34566-1823	G	0	A	BLACK	72	71	70	69	68	66	65	64		61	59	58	56	55	54	53			
							52	50	49		47				42	41		38	37	36		34	33		
							73				32	31	30	29	28	27	26	24	23	22	21	20	19	18	17
										16		13	12	11	10	9	8							1	
AVAILABLE	NOT APPLICABLE	34566-1833	G	0	A	BLACK				68		65	63	61	59	58	56								
							52	50			47				41		38	37	36		34	33			
							73				32	31	30	29	28	27	25	24	23		20	19	18	17	
										16		13	12	11	10									1	
AVAILABLE	NOT APPLICABLE	34566-1843	G	0	A	BLACK				68		65	63	61	59	58	56								
							52	50			47				41		38	37	36		34	33			
							73				32	31	30	29	28	27	24	23	22	21	20	19	18	17	
										16	15	14	13	12	11	10								1	
AVAILABLE	NOT APPLICABLE	34566-1853	G	0	A	BLACK	72	70	69	68	67		65	63	61	60		57	56	55	54	53			
							52	50	49	48	47		44	43	41	40			37	36	35	34	33		
							73				30	29	28		25	24		21	20	19	18	17			
										16	15			11	10	9	8	7	6	5	4	3	2	1	
AVAILABLE	NOT APPLICABLE	34566-1863	G	0	B	ST GRAY				68	67	66	65	64	63										
															43										
										32	30	29	28	27									17		
										16					10										

<b>ENTER DESCRIPTION</b> EC NO: UAU2010-1551 DRAWN BY: DRWNAH01 CHECKED BY: CHKDRFF1 APPROVED BY: APPR.VKOSHY DATE: 2010/03/15 DATE: 2008/05/09 DATE: 2010/03/18	<b>QUALITY SYMBOLS</b> ▽=0 ▽=0	<b>GENERAL TOLERANCES (UNLESS SPECIFIED)</b> <table border="1"> <tr> <th></th> <th>mm</th> <th>INCH</th> </tr> <tr> <td>4 PLACES ±</td> <td>---</td> <td>---</td> </tr> <tr> <td>3 PLACES ±</td> <td>---</td> <td>---</td> </tr> <tr> <td>2 PLACES ±</td> <td>---</td> <td>---</td> </tr> <tr> <td>1 PLACE ±</td> <td>---</td> <td>---</td> </tr> </table>		mm	INCH	4 PLACES ±	---	---	3 PLACES ±	---	---	2 PLACES ±	---	---	1 PLACE ±	---	---	<b>DIMENSION STYLE</b> <b>MM ONLY</b>	<b>SCALE</b> <b>1:1</b>	<b>DESIGN UNITS</b> <b>METRIC</b>	<b>THIRD ANGLE PROJECTION</b>
		mm	INCH																		
	4 PLACES ±	---	---																		
	3 PLACES ±	---	---																		
2 PLACES ±	---	---																			
1 PLACE ±	---	---																			
<b>DESCRIPTION</b> <b>740</b>	<b>DRAFT WHERE APPLICABLE MUST REMAIN WITHIN DIMENSIONS</b>	<b>DRAWN BY</b> SRAJENDRANAT	<b>DATE</b> 2008/05/09	<b>CHECKED BY</b> TSKIVER	<b>DATE</b> 2008/05/09	<b>APPROVED BY</b> VKOSHY	<b>DATE</b> 2010/03/18														
<b>MATERIAL NO.</b> <b>SD-34566-001</b>	<b>DRAWING NO.</b> <b>SD-34566-001</b>	<b>SHEET NO.</b> 23 OF 36	<b>MOLEX INCORPORATED</b>																		
<b>THIS DRAWING CONTAINS INFORMATION THAT IS PROPRIETARY TO MOLEX INCORPORATED AND SHOULD NOT BE USED WITHOUT WRITTEN PERMISSION</b>																					

19 18 17 16 15 14 13 12 11 10 9 8 7 6 5 4 3 2 1









20	19	18	17	16	15	14	13	12	11	10	9	8	7	6	5	4	3	2	1							
										STATUS	GM PART #	MATERIAL #	PART / MATERIAL REVISION	WIRE DRESS OPTION	KEY OPTION	COLOR (TPA)	NUMBERS INDICATE CAVITIES OPEN FOR CIRCUITS									
										AVAILABLE	NOT APPLICABLE	34566-2293	G	0	C	BLUE	72 70 68 66 63 59 57 53 52 51 48 47 46 44 42 40 39 34 33 73 30 26 25 22 21 15 14 10 9 6									
										AVAILABLE	NOT APPLICABLE	34566-2319	G	0	C	BLUE	72 70 66 63 59 57 53 52 51 46 44 42 40 39 34 33 73 30 26 25 22 21 15 14 10 9 6									
										AVAILABLE	NOT APPLICABLE	34566-2323	G	0	C	BLUE	72 70 68 66 63 59 57 53 52 51 48 47 46 44 42 40 39 34 33 73 30 26 25 22 21 20 15 14 10 9 6 5 4									
										AVAILABLE	NOT APPLICABLE	34566-2333	G	0	A	BLACK	71 69 68 65 64 63 61 59 57 56 54 53 52 50 49 47 46 45 44 43 42 41 39 38 37 36 34 33 73 32 31 30 29 28 27 26 25 24 23 22 20 19 18 16 15 14 13 12 11 10 9 8 7 6 5 4 3 2 1									
										AVAILABLE	NOT APPLICABLE	34566-2343	G	0	A	BLACK	72 70 68 67 66 65 64 63 62 61 59 57 55 53 52 51 49 47 46 45 44 43 42 41 39 37 35 34 33 73 32 30 27 25 24 23 22 21 20 19 18 17 16 15 14 13 9 8 6 5 3 1									
										AVAILABLE	NOT APPLICABLE	34566-2353	G	0	A	BLACK	72 70 67 66 65 64 63 62 61 59 57 55 53 52 51 49 47 46 45 44 43 42 41 39 37 35 34 33 73 32 30 27 25 24 23 22 21 20 19 18 17 16 15 14 13 9 8 6 5 3 1									
										AVAILABLE	NOT APPLICABLE	34566-2363	G	0	C	BLUE	72 70 67 66 63 62 59 57 53 52 51 46 44 42 40 39 38 34 33 73 32 30 27 26 25 22 21 20 15 14 10 9 6 5 4									
										AVAILABLE	NOT APPLICABLE	34566-2373	G	0	B	ST GRAY	68 67 66 65 64 61 60 59 58 57 55 54 53 51 50 49 48 47 46 45 43 42 41 40 39 38 37 35 34 33 73 32 31 30 26 24 23 22 21 20 16 15 14 13 10 9 8 7 6 5 4 3 2									
										AVAILABLE	NOT APPLICABLE	34566-2383	G	0	B	ST GRAY	65 59 57 55 53 50 49 48 46 44 43 42 41 39 37 35 33 73 15 29 24 23 21 7 6 5 4 3									

<b>ENTER DESCRIPTION</b> SEC NO: UAU2010-151 DRAWN BY: SRAJENDRANAT CHECKED BY: TSK IVER APPROVED BY: VKOSHY DATE: 2010/03/18 APPR: VKOSHY	QUALITY SYMBOLS	GENERAL TOLERANCES (UNLESS SPECIFIED)	DIMENSION STYLE	SCALE	DESIGN UNITS	THIRD ANGLE PROJECTION	
	$\nabla=0$ $\nabla=0$	mm INCH 4 PLACES ±--- ±--- 3 PLACES ±--- ±--- 2 PLACES ±--- ±--- 1 PLACE ±--- ±--- ANGULAR ±---°	DRAWN BY DATE SRAJENDRANAT 2008/05/09 CHECKED BY DATE TSK IVER 2008/05/09 APPROVED BY DATE VKOSHY 2010/03/18	MM ONLY	1:1	METRIC	TITLE MX123 73/80 CKT HRNS CONN ASSY
	DRAFT WHERE APPLICABLE MUST REMAIN WITHIN DIMENSIONS	SEE BOM TABLE	MATERIAL NO. SD-34566-001	MOLEX INCORPORATED			
	F40		DOCUMENT NO. SD-34566-001	SHEET NO. 28 OF 36			



STATUS	GM PART #	MATERIAL #	PART / MATERIAL REVISION	WIRE DRESS OPTION	KEY OPTION	COLOR (TPA)	NUMBERS INDICATE CAVITIES OPEN FOR CIRCUITS																																																																																									
AVAILABLE	NOT APPLICABLE	34566-2483	G	0	A	BLACK	<table border="1"> <tr><td></td><td></td><td>69</td><td></td><td></td><td></td><td>63</td><td>62</td><td>61</td><td></td><td>58</td><td>57</td><td>56</td><td>55</td><td>54</td><td>53</td></tr> <tr><td>52</td><td>51</td><td>49</td><td></td><td></td><td></td><td>44</td><td>43</td><td>42</td><td>41</td><td></td><td>37</td><td>36</td><td>35</td><td>34</td><td>33</td></tr> <tr><td></td><td></td><td>73</td><td></td><td>32</td><td></td><td>29</td><td>28</td><td>27</td><td>26</td><td></td><td>23</td><td></td><td></td><td>19</td><td>18</td></tr> <tr><td></td><td></td><td></td><td></td><td>16</td><td></td><td>13</td><td>12</td><td>11</td><td>10</td><td></td><td>8</td><td></td><td></td><td>3</td><td></td></tr> </table>			69				63	62	61		58	57	56	55	54	53	52	51	49				44	43	42	41		37	36	35	34	33			73		32		29	28	27	26		23			19	18					16		13	12	11	10		8			3																										
		69				63	62	61		58	57	56	55	54	53																																																																																	
52	51	49				44	43	42	41		37	36	35	34	33																																																																																	
		73		32		29	28	27	26		23			19	18																																																																																	
				16		13	12	11	10		8			3																																																																																		
AVAILABLE	NOT APPLICABLE	34566-2493	G	0	B	ST GRAY	<table border="1"> <tr><td>72</td><td>71</td><td>70</td><td></td><td>68</td><td>67</td><td>66</td><td></td><td></td><td></td><td>62</td><td>61</td><td>60</td><td>59</td><td>58</td><td>57</td><td>56</td><td>55</td><td>54</td><td>53</td></tr> <tr><td>52</td><td>51</td><td>50</td><td></td><td>48</td><td>47</td><td>46</td><td></td><td></td><td></td><td>42</td><td>41</td><td>40</td><td>39</td><td>38</td><td>37</td><td>36</td><td>35</td><td>34</td><td>33</td></tr> <tr><td></td><td></td><td>73</td><td></td><td>32</td><td>31</td><td>30</td><td>29</td><td>28</td><td>27</td><td>26</td><td>25</td><td>24</td><td></td><td></td><td></td><td></td><td></td><td></td><td>17</td></tr> <tr><td></td><td></td><td></td><td></td><td>16</td><td>15</td><td>14</td><td>13</td><td></td><td></td><td>10</td><td></td><td>8</td><td></td><td></td><td></td><td></td><td></td><td></td><td>2</td><td>1</td></tr> </table>	72	71	70		68	67	66				62	61	60	59	58	57	56	55	54	53	52	51	50		48	47	46				42	41	40	39	38	37	36	35	34	33			73		32	31	30	29	28	27	26	25	24							17					16	15	14	13			10		8							2	1								
72	71	70		68	67	66				62	61	60	59	58	57	56	55	54	53																																																																													
52	51	50		48	47	46				42	41	40	39	38	37	36	35	34	33																																																																													
		73		32	31	30	29	28	27	26	25	24							17																																																																													
				16	15	14	13			10		8							2	1																																																																												
AVAILABLE	NOT APPLICABLE	34566-2513	G	0	C	BLUE	<table border="1"> <tr><td>72</td><td>71</td><td>70</td><td></td><td>68</td><td>67</td><td>66</td><td></td><td></td><td></td><td>63</td><td>62</td><td></td><td></td><td>59</td><td>57</td><td></td><td></td><td></td><td>53</td></tr> <tr><td>52</td><td>51</td><td></td><td></td><td>48</td><td>47</td><td>46</td><td></td><td></td><td></td><td>44</td><td>42</td><td>40</td><td>39</td><td></td><td></td><td></td><td></td><td></td><td>34</td><td>33</td></tr> <tr><td></td><td></td><td>73</td><td></td><td>32</td><td></td><td>30</td><td></td><td></td><td></td><td>27</td><td>26</td><td>25</td><td></td><td></td><td>22</td><td>21</td><td>20</td><td></td><td></td><td></td></tr> <tr><td></td><td></td><td></td><td></td><td>15</td><td>14</td><td></td><td></td><td></td><td></td><td>10</td><td>9</td><td></td><td></td><td>6</td><td>5</td><td>4</td><td></td><td></td><td></td><td></td></tr> </table>	72	71	70		68	67	66				63	62			59	57				53	52	51			48	47	46				44	42	40	39						34	33			73		32		30				27	26	25			22	21	20								15	14					10	9			6	5	4										
72	71	70		68	67	66				63	62			59	57				53																																																																													
52	51			48	47	46				44	42	40	39						34	33																																																																												
		73		32		30				27	26	25			22	21	20																																																																															
				15	14					10	9			6	5	4																																																																																
AVAILABLE	NOT APPLICABLE	34566-2523	G	0	A	BLACK	<table border="1"> <tr><td>72</td><td>71</td><td>70</td><td>69</td><td>68</td><td>67</td><td>66</td><td>65</td><td>64</td><td>63</td><td>62</td><td></td><td></td><td>60</td><td>59</td><td></td><td></td><td></td><td>55</td><td>54</td><td>53</td></tr> <tr><td>52</td><td></td><td>49</td><td>48</td><td></td><td></td><td></td><td></td><td>45</td><td>44</td><td>43</td><td>42</td><td>41</td><td>40</td><td>39</td><td></td><td></td><td></td><td></td><td>35</td><td>34</td><td>33</td></tr> <tr><td></td><td></td><td>73</td><td></td><td>32</td><td></td><td></td><td></td><td>29</td><td>28</td><td>27</td><td></td><td></td><td>25</td><td>24</td><td>23</td><td></td><td></td><td></td><td>19</td><td>18</td><td>17</td></tr> <tr><td></td><td></td><td></td><td></td><td>16</td><td></td><td></td><td></td><td>13</td><td>12</td><td>11</td><td></td><td></td><td>9</td><td>8</td><td>7</td><td>6</td><td>5</td><td>4</td><td>3</td><td>2</td><td>1</td></tr> </table>	72	71	70	69	68	67	66	65	64	63	62			60	59				55	54	53	52		49	48					45	44	43	42	41	40	39					35	34	33			73		32				29	28	27			25	24	23				19	18	17					16				13	12	11			9	8	7	6	5	4	3	2	1		
72	71	70	69	68	67	66	65	64	63	62			60	59				55	54	53																																																																												
52		49	48					45	44	43	42	41	40	39					35	34	33																																																																											
		73		32				29	28	27			25	24	23				19	18	17																																																																											
				16				13	12	11			9	8	7	6	5	4	3	2	1																																																																											
AVAILABLE	NOT APPLICABLE	34566-2533	G	0	B	ST GRAY	<table border="1"> <tr><td></td><td></td><td></td><td></td><td>67</td><td>66</td><td>65</td><td></td><td></td><td></td><td></td><td></td><td></td><td></td><td>59</td><td>58</td><td>57</td><td>56</td><td>55</td><td></td><td>53</td></tr> <tr><td></td><td></td><td></td><td>50</td><td>49</td><td>48</td><td></td><td>46</td><td>45</td><td>43</td><td></td><td></td><td></td><td></td><td>39</td><td>38</td><td>37</td><td>36</td><td>35</td><td>34</td><td>33</td></tr> <tr><td></td><td></td><td>73</td><td></td><td></td><td></td><td></td><td></td><td>29</td><td>27</td><td></td><td></td><td></td><td></td><td>23</td><td>22</td><td>21</td><td></td><td></td><td></td><td>18</td></tr> <tr><td></td><td></td><td></td><td></td><td>16</td><td>15</td><td>14</td><td>13</td><td></td><td></td><td></td><td></td><td></td><td>8</td><td>7</td><td>6</td><td>5</td><td>4</td><td>3</td><td></td><td></td></tr> </table>					67	66	65								59	58	57	56	55		53				50	49	48		46	45	43					39	38	37	36	35	34	33			73						29	27					23	22	21				18					16	15	14	13						8	7	6	5	4	3							
				67	66	65								59	58	57	56	55		53																																																																												
			50	49	48		46	45	43					39	38	37	36	35	34	33																																																																												
		73						29	27					23	22	21				18																																																																												
				16	15	14	13						8	7	6	5	4	3																																																																														
AVAILABLE	NOT APPLICABLE	34566-2543	G	0	C	BLUE	<table border="1"> <tr><td>72</td><td>71</td><td>70</td><td></td><td></td><td></td><td>66</td><td></td><td></td><td></td><td>63</td><td></td><td></td><td></td><td>59</td><td>57</td><td></td><td></td><td></td><td></td><td>53</td></tr> <tr><td>52</td><td>51</td><td></td><td></td><td></td><td></td><td>46</td><td></td><td></td><td></td><td>44</td><td>42</td><td>40</td><td>39</td><td></td><td></td><td></td><td></td><td></td><td></td><td>34</td><td>33</td></tr> <tr><td></td><td></td><td>73</td><td></td><td></td><td></td><td>32</td><td></td><td></td><td></td><td>30</td><td></td><td></td><td></td><td>27</td><td>26</td><td>25</td><td></td><td></td><td>22</td><td>21</td><td></td></tr> <tr><td></td><td></td><td></td><td></td><td></td><td></td><td>15</td><td>14</td><td></td><td></td><td></td><td></td><td></td><td>10</td><td>9</td><td></td><td></td><td></td><td>6</td><td></td><td></td><td></td></tr> </table>	72	71	70				66				63				59	57					53	52	51					46				44	42	40	39							34	33			73				32				30				27	26	25			22	21								15	14						10	9				6					
72	71	70				66				63				59	57					53																																																																												
52	51					46				44	42	40	39							34	33																																																																											
		73				32				30				27	26	25			22	21																																																																												
						15	14						10	9				6																																																																														
AVAILABLE	NOT APPLICABLE	34566-2553	G	9	B	ST GRAY	<table border="1"> <tr><td>72</td><td>71</td><td>70</td><td></td><td>68</td><td>67</td><td>66</td><td></td><td></td><td></td><td>62</td><td>61</td><td>60</td><td>59</td><td>58</td><td>57</td><td>56</td><td>55</td><td>54</td><td>53</td></tr> <tr><td>52</td><td>51</td><td>50</td><td></td><td>48</td><td>47</td><td>46</td><td></td><td></td><td></td><td>42</td><td>41</td><td>40</td><td>39</td><td>38</td><td>37</td><td>36</td><td>35</td><td>34</td><td>33</td></tr> <tr><td></td><td></td><td>73</td><td></td><td>32</td><td>31</td><td>30</td><td>29</td><td>28</td><td>27</td><td>26</td><td>25</td><td>24</td><td>23</td><td></td><td></td><td></td><td></td><td></td><td></td><td></td></tr> <tr><td></td><td></td><td></td><td></td><td>16</td><td>15</td><td>14</td><td>13</td><td></td><td></td><td>10</td><td>9</td><td>8</td><td></td><td></td><td></td><td></td><td></td><td></td><td></td><td></td></tr> </table>	72	71	70		68	67	66				62	61	60	59	58	57	56	55	54	53	52	51	50		48	47	46				42	41	40	39	38	37	36	35	34	33			73		32	31	30	29	28	27	26	25	24	23												16	15	14	13			10	9	8															
72	71	70		68	67	66				62	61	60	59	58	57	56	55	54	53																																																																													
52	51	50		48	47	46				42	41	40	39	38	37	36	35	34	33																																																																													
		73		32	31	30	29	28	27	26	25	24	23																																																																																			
				16	15	14	13			10	9	8																																																																																				
AVAILABLE	NOT APPLICABLE	34566-2563	G	9	A	BLACK	<table border="1"> <tr><td></td><td></td><td>69</td><td></td><td></td><td></td><td></td><td></td><td></td><td></td><td>63</td><td>62</td><td>61</td><td></td><td>58</td><td>57</td><td>56</td><td>55</td><td>54</td><td>53</td></tr> <tr><td>52</td><td>51</td><td>50</td><td>49</td><td></td><td></td><td></td><td></td><td></td><td></td><td>44</td><td>43</td><td>42</td><td>41</td><td></td><td></td><td></td><td></td><td>37</td><td>36</td><td>35</td><td>34</td><td>33</td></tr> <tr><td></td><td></td><td>73</td><td></td><td>32</td><td></td><td></td><td></td><td>29</td><td>28</td><td>27</td><td>26</td><td></td><td></td><td></td><td></td><td></td><td></td><td></td><td>19</td><td>18</td><td></td><td></td></tr> <tr><td></td><td></td><td></td><td></td><td>16</td><td></td><td></td><td></td><td>14</td><td>13</td><td>12</td><td>11</td><td>10</td><td></td><td></td><td></td><td></td><td></td><td></td><td>3</td><td></td><td></td><td></td></tr> </table>			69								63	62	61		58	57	56	55	54	53	52	51	50	49							44	43	42	41					37	36	35	34	33			73		32				29	28	27	26								19	18							16				14	13	12	11	10							3			
		69								63	62	61		58	57	56	55	54	53																																																																													
52	51	50	49							44	43	42	41					37	36	35	34	33																																																																										
		73		32				29	28	27	26								19	18																																																																												
				16				14	13	12	11	10							3																																																																													
AVAILABLE	NOT APPLICABLE	34566-2573	G	9	C	BLUE	<table border="1"> <tr><td>72</td><td>71</td><td>70</td><td></td><td></td><td></td><td>67</td><td>66</td><td></td><td></td><td>63</td><td>62</td><td></td><td></td><td>59</td><td>57</td><td></td><td></td><td></td><td></td><td>53</td></tr> <tr><td>52</td><td>51</td><td></td><td></td><td></td><td></td><td>46</td><td>44</td><td></td><td></td><td>42</td><td>40</td><td>39</td><td></td><td></td><td></td><td></td><td></td><td></td><td></td><td>34</td><td>33</td></tr> <tr><td></td><td></td><td>73</td><td></td><td></td><td></td><td>30</td><td></td><td></td><td></td><td>26</td><td>25</td><td></td><td></td><td></td><td>22</td><td>21</td><td>20</td><td></td><td></td><td></td><td></td></tr> <tr><td></td><td></td><td></td><td></td><td></td><td></td><td>15</td><td>14</td><td></td><td></td><td>10</td><td>9</td><td></td><td></td><td>6</td><td>5</td><td>4</td><td></td><td></td><td></td><td></td><td></td></tr> </table>	72	71	70				67	66			63	62			59	57					53	52	51					46	44			42	40	39								34	33			73				30				26	25				22	21	20											15	14			10	9			6	5	4							
72	71	70				67	66			63	62			59	57					53																																																																												
52	51					46	44			42	40	39								34	33																																																																											
		73				30				26	25				22	21	20																																																																															
						15	14			10	9			6	5	4																																																																																

<b>ENTER DESCRIPTION</b> TEC NO. JAU2010-1551 DRAWN BY CHYKORFF JHS CHECKED BY APPR:VKOSHY DATE 2010/03/15 DATE 2008/05/09 DATE 2010/03/18	QUALITY SYMBOLS ▽=0 ▽=0	GENERAL TOLERANCES (UNLESS SPECIFIED) mm INCH 4 PLACES ±--- ±--- 3 PLACES ±--- ±--- 2 PLACES ±--- ±--- 1 PLACE ±--- ±--- ANGULAR ±---°	DIMENSION STYLE <b>MM ONLY</b>	SCALE <b>1:1</b>	DESIGN UNITS <b>METRIC</b>	THIRD ANGLE PROJECTION ☉	
	DRAWN BY DATE SRAJENDRANAT 2008/05/09	CHECKED BY DATE TSK IVER 2008/05/09	APPROVED BY DATE VKOSHY 2010/03/18	MATERIAL NO. <b>SEE BOM TABLE</b>	DOCUMENT NO. <b>SD-34566-001</b>	TITLE <b>MX123 73/80 CKT HRNS CONN ASSY</b>	SHEET NO. <b>30 OF 36</b>
	MOLEX INCORPORATED						
	THIS DRAWING CONTAINS INFORMATION THAT IS PROPRIETARY TO MOLEX INCORPORATED AND SHOULD NOT BE USED WITHOUT WRITTEN PERMISSION						

STATUS	GM PART #	MATERIAL #	PART/MATERIAL REVISION	WIRE DRESS OPTION	KEY OPTION	COLOR (TPA)	NUMBERS INDICATE CAVITIES OPEN FOR CIRCUITS																																																																										
AVAILABLE	NOT APPLICABLE	34566-2583	G	0	A	BLACK	<table border="1"> <tr><td></td><td></td><td>69</td><td></td><td></td><td></td><td>63</td><td></td><td></td><td>58</td><td>56</td><td>55</td><td>54</td><td>53</td></tr> <tr><td>52</td><td>51</td><td>50</td><td>49</td><td></td><td></td><td>44</td><td>43</td><td>42</td><td>41</td><td>39</td><td></td><td>36</td><td>35</td><td>34</td><td>33</td></tr> <tr><td></td><td></td><td>73</td><td>32</td><td></td><td></td><td>28</td><td>26</td><td></td><td></td><td></td><td></td><td>19</td><td>18</td><td></td><td></td></tr> <tr><td></td><td></td><td></td><td>16</td><td>14</td><td></td><td>12</td><td>10</td><td></td><td></td><td></td><td></td><td></td><td>3</td><td></td><td></td></tr> </table>			69				63			58	56	55	54	53	52	51	50	49			44	43	42	41	39		36	35	34	33			73	32			28	26					19	18						16	14		12	10						3														
		69				63			58	56	55	54	53																																																																				
52	51	50	49			44	43	42	41	39		36	35	34	33																																																																		
		73	32			28	26					19	18																																																																				
			16	14		12	10						3																																																																				
AVAILABLE	NOT APPLICABLE	34566-2593	G	0	C	BLUE	<table border="1"> <tr><td>72</td><td>70</td><td></td><td></td><td>66</td><td></td><td>63</td><td>62</td><td></td><td>59</td><td>57</td><td></td><td></td><td></td><td></td><td>53</td></tr> <tr><td>52</td><td>51</td><td></td><td></td><td>46</td><td>44</td><td>42</td><td>41</td><td>40</td><td>39</td><td></td><td></td><td></td><td></td><td>34</td><td>33</td></tr> <tr><td></td><td></td><td>73</td><td>32</td><td>30</td><td></td><td>27</td><td>26</td><td>25</td><td></td><td>22</td><td>21</td><td></td><td></td><td></td><td></td></tr> <tr><td></td><td></td><td></td><td></td><td>15</td><td>14</td><td></td><td></td><td>10</td><td>9</td><td>6</td><td></td><td></td><td></td><td></td><td></td></tr> </table>	72	70			66		63	62		59	57					53	52	51			46	44	42	41	40	39					34	33			73	32	30		27	26	25		22	21									15	14			10	9	6															
72	70			66		63	62		59	57					53																																																																		
52	51			46	44	42	41	40	39					34	33																																																																		
		73	32	30		27	26	25		22	21																																																																						
				15	14			10	9	6																																																																							
AVAILABLE	NOT APPLICABLE	34566-2613	G	9	C	BLUE	<table border="1"> <tr><td>72</td><td>70</td><td></td><td>67</td><td>66</td><td></td><td>63</td><td>62</td><td></td><td>59</td><td>57</td><td></td><td></td><td></td><td></td><td>53</td></tr> <tr><td>52</td><td>51</td><td></td><td></td><td>46</td><td>44</td><td>42</td><td>41</td><td>40</td><td>39</td><td></td><td></td><td></td><td></td><td>34</td><td>33</td></tr> <tr><td></td><td></td><td>73</td><td></td><td>30</td><td></td><td>27</td><td>26</td><td>25</td><td></td><td>22</td><td>21</td><td>20</td><td></td><td></td><td></td></tr> <tr><td></td><td></td><td></td><td></td><td>15</td><td>14</td><td></td><td></td><td>10</td><td>9</td><td>6</td><td>5</td><td>4</td><td></td><td></td><td></td></tr> </table>	72	70		67	66		63	62		59	57					53	52	51			46	44	42	41	40	39					34	33			73		30		27	26	25		22	21	20								15	14			10	9	6	5	4													
72	70		67	66		63	62		59	57					53																																																																		
52	51			46	44	42	41	40	39					34	33																																																																		
		73		30		27	26	25		22	21	20																																																																					
				15	14			10	9	6	5	4																																																																					
AVAILABLE	NOT APPLICABLE	34566-2623	G	0	A	BLACK	<table border="1"> <tr><td></td><td>71</td><td>69</td><td>68</td><td>67</td><td>65</td><td>64</td><td>63</td><td>61</td><td>59</td><td>57</td><td>56</td><td></td><td></td><td></td><td></td></tr> <tr><td></td><td></td><td>50</td><td>49</td><td>47</td><td></td><td></td><td></td><td>41</td><td></td><td>38</td><td>37</td><td>36</td><td></td><td>34</td><td>33</td></tr> <tr><td></td><td></td><td>73</td><td>32</td><td>31</td><td>30</td><td>29</td><td>28</td><td>27</td><td></td><td>24</td><td>23</td><td></td><td>20</td><td>19</td><td>18</td></tr> <tr><td></td><td></td><td></td><td>16</td><td></td><td></td><td>13</td><td>12</td><td>11</td><td>10</td><td>9</td><td>7</td><td></td><td>4</td><td></td><td></td></tr> </table>		71	69	68	67	65	64	63	61	59	57	56							50	49	47				41		38	37	36		34	33			73	32	31	30	29	28	27		24	23		20	19	18				16			13	12	11	10	9	7		4												
	71	69	68	67	65	64	63	61	59	57	56																																																																						
		50	49	47				41		38	37	36		34	33																																																																		
		73	32	31	30	29	28	27		24	23		20	19	18																																																																		
			16			13	12	11	10	9	7		4																																																																				
AVAILABLE	NOT APPLICABLE	34566-2633	G	0	A	BLACK	<table border="1"> <tr><td></td><td>71</td><td>69</td><td>68</td><td>67</td><td>65</td><td>64</td><td></td><td>61</td><td>59</td><td>57</td><td>56</td><td></td><td></td><td></td><td></td></tr> <tr><td></td><td></td><td>50</td><td>49</td><td>47</td><td></td><td></td><td></td><td>41</td><td></td><td>38</td><td>37</td><td>36</td><td></td><td>34</td><td>33</td></tr> <tr><td></td><td></td><td>73</td><td>32</td><td>31</td><td>30</td><td>29</td><td>28</td><td>27</td><td></td><td>24</td><td>23</td><td></td><td>20</td><td>19</td><td>18</td></tr> <tr><td></td><td></td><td></td><td>16</td><td></td><td></td><td></td><td></td><td>11</td><td>10</td><td>9</td><td>7</td><td></td><td>4</td><td></td><td></td></tr> </table>		71	69	68	67	65	64		61	59	57	56							50	49	47				41		38	37	36		34	33			73	32	31	30	29	28	27		24	23		20	19	18				16					11	10	9	7		4												
	71	69	68	67	65	64		61	59	57	56																																																																						
		50	49	47				41		38	37	36		34	33																																																																		
		73	32	31	30	29	28	27		24	23		20	19	18																																																																		
			16					11	10	9	7		4																																																																				
AVAILABLE	NOT APPLICABLE	34566-2643	G	0	A	BLACK	<table border="1"> <tr><td></td><td>71</td><td>69</td><td>68</td><td>67</td><td>65</td><td>64</td><td>63</td><td>61</td><td>59</td><td>57</td><td>56</td><td></td><td></td><td></td><td></td></tr> <tr><td></td><td></td><td>50</td><td>49</td><td>47</td><td></td><td></td><td></td><td>41</td><td>39</td><td>38</td><td>37</td><td>36</td><td></td><td>34</td><td>33</td></tr> <tr><td></td><td></td><td>73</td><td>32</td><td>31</td><td>30</td><td>29</td><td>28</td><td>27</td><td></td><td>24</td><td>23</td><td>22</td><td></td><td>20</td><td>19</td><td>18</td></tr> <tr><td></td><td></td><td></td><td>16</td><td></td><td></td><td>13</td><td>12</td><td>11</td><td>10</td><td>9</td><td>7</td><td></td><td>4</td><td></td><td></td><td></td></tr> </table>		71	69	68	67	65	64	63	61	59	57	56							50	49	47				41	39	38	37	36		34	33			73	32	31	30	29	28	27		24	23	22		20	19	18				16			13	12	11	10	9	7		4											
	71	69	68	67	65	64	63	61	59	57	56																																																																						
		50	49	47				41	39	38	37	36		34	33																																																																		
		73	32	31	30	29	28	27		24	23	22		20	19	18																																																																	
			16			13	12	11	10	9	7		4																																																																				
AVAILABLE	NOT APPLICABLE	34566-2653	G	0	A	BLACK	<table border="1"> <tr><td></td><td>71</td><td>69</td><td>68</td><td>67</td><td>65</td><td>64</td><td></td><td>61</td><td>59</td><td>57</td><td>56</td><td></td><td></td><td></td><td></td></tr> <tr><td></td><td></td><td>50</td><td>49</td><td>47</td><td></td><td></td><td></td><td>41</td><td>39</td><td>38</td><td>37</td><td>36</td><td></td><td>34</td><td>33</td></tr> <tr><td></td><td></td><td>73</td><td>32</td><td>31</td><td>30</td><td>29</td><td>28</td><td>27</td><td></td><td>24</td><td>23</td><td>22</td><td></td><td>20</td><td>19</td><td>18</td></tr> <tr><td></td><td></td><td></td><td>16</td><td></td><td></td><td></td><td></td><td>11</td><td>10</td><td>9</td><td>7</td><td></td><td>4</td><td></td><td></td><td></td></tr> </table>		71	69	68	67	65	64		61	59	57	56							50	49	47				41	39	38	37	36		34	33			73	32	31	30	29	28	27		24	23	22		20	19	18				16					11	10	9	7		4											
	71	69	68	67	65	64		61	59	57	56																																																																						
		50	49	47				41	39	38	37	36		34	33																																																																		
		73	32	31	30	29	28	27		24	23	22		20	19	18																																																																	
			16					11	10	9	7		4																																																																				
AVAILABLE	NOT APPLICABLE	34566-2663	G	0	H	ST GRAY	<table border="1"> <tr><td></td><td>79</td><td>78</td><td>77</td><td>76</td><td>75</td><td>74</td><td>73</td><td>72</td><td>71</td><td>70</td><td>69</td><td>68</td><td>66</td><td>65</td><td>64</td><td>63</td><td>61</td></tr> <tr><td>60</td><td>59</td><td>58</td><td>57</td><td>56</td><td></td><td></td><td>53</td><td>52</td><td></td><td>50</td><td></td><td></td><td></td><td></td><td>44</td><td>43</td><td>41</td></tr> <tr><td>40</td><td>39</td><td>38</td><td>37</td><td></td><td>35</td><td>34</td><td></td><td>32</td><td></td><td>30</td><td>29</td><td></td><td>27</td><td>26</td><td></td><td></td><td>22</td><td>21</td></tr> <tr><td>20</td><td>19</td><td>18</td><td>17</td><td></td><td></td><td></td><td>13</td><td>12</td><td></td><td></td><td></td><td>8</td><td>6</td><td>5</td><td></td><td>3</td><td>2</td><td></td></tr> </table>		79	78	77	76	75	74	73	72	71	70	69	68	66	65	64	63	61	60	59	58	57	56			53	52		50					44	43	41	40	39	38	37		35	34		32		30	29		27	26			22	21	20	19	18	17				13	12				8	6	5		3	2	
	79	78	77	76	75	74	73	72	71	70	69	68	66	65	64	63	61																																																																
60	59	58	57	56			53	52		50					44	43	41																																																																
40	39	38	37		35	34		32		30	29		27	26			22	21																																																															
20	19	18	17				13	12				8	6	5		3	2																																																																
AVAILABLE	NOT APPLICABLE	34566-2673	G	0	H	ST GRAY	<table border="1"> <tr><td></td><td>79</td><td>78</td><td>77</td><td>76</td><td>75</td><td>74</td><td>73</td><td>72</td><td>71</td><td>70</td><td>69</td><td>68</td><td>66</td><td>65</td><td>64</td><td>63</td><td>61</td></tr> <tr><td>60</td><td>59</td><td>58</td><td>57</td><td>56</td><td></td><td></td><td>53</td><td>52</td><td></td><td>50</td><td></td><td></td><td></td><td></td><td>44</td><td>43</td><td>41</td></tr> <tr><td>40</td><td>39</td><td>38</td><td>37</td><td></td><td>35</td><td>34</td><td></td><td>32</td><td></td><td>30</td><td>29</td><td></td><td>27</td><td>26</td><td></td><td></td><td>22</td><td>21</td></tr> <tr><td>20</td><td>19</td><td>18</td><td>17</td><td>16</td><td></td><td></td><td>13</td><td>12</td><td></td><td></td><td></td><td>8</td><td>6</td><td>5</td><td></td><td>3</td><td>2</td><td></td></tr> </table>		79	78	77	76	75	74	73	72	71	70	69	68	66	65	64	63	61	60	59	58	57	56			53	52		50					44	43	41	40	39	38	37		35	34		32		30	29		27	26			22	21	20	19	18	17	16			13	12				8	6	5		3	2	
	79	78	77	76	75	74	73	72	71	70	69	68	66	65	64	63	61																																																																
60	59	58	57	56			53	52		50					44	43	41																																																																
40	39	38	37		35	34		32		30	29		27	26			22	21																																																															
20	19	18	17	16			13	12				8	6	5		3	2																																																																

<b>ENTER DESCRIPTION</b> TEC NO. UAU2010-1551 DRAWN BY: CHYKORFF   HS CHECKED BY: APPR:VKOSHY DATE: 2010/03/18 DATE: 2008/05/09 DATE: 2010/03/18	QUALITY SYMBOLS ▽=0 ▽=0	GENERAL TOLERANCES (UNLESS SPECIFIED) mm INCH 4 PLACES ±--- ±--- 3 PLACES ±--- ±--- 2 PLACES ±--- ±--- 1 PLACE ±--- ±--- ANGULAR ±---°	DIMENSION STYLE <b>MM ONLY</b>	SCALE <b>1:1</b>	DESIGN UNITS <b>METRIC</b>	THIRD ANGLE PROJECTION 	
	DRAFT WHERE APPLICABLE MUST REMAIN WITHIN DIMENSIONS		DRAWN BY: SRAJENDRANAT   DATE: 2008/05/09 CHECKED BY: TSK   DATE: 2008/05/09 APPROVED BY: VKOSHY   DATE: 2010/03/18	TITLE <b>MX123 73/80 CKT HRNS CONN ASSY</b>		MATERIAL NO. NOT <b>SEE BOM TABLE</b>	DOCUMENT NO. <b>SD-34566-001</b>
	SIZE <b>D</b>		THIS DRAWING CONTAINS INFORMATION THAT IS PROPRIETARY TO MOLEX INCORPORATED AND SHOULD NOT BE USED WITHOUT WRITTEN PERMISSION		MOLEX INCORPORATED		SHEET NO. <b>31 OF 36</b>
	MOLEX INCORPORATED						





STATUS	GM PART #	MATERIAL #	PART/MATERIAL REVISION	WIRE DRESS OPTION	KEY OPTION	COLOR (TPA)	NUMBERS INDICATE CAVITIES OPEN FOR CIRCUITS																																																																													
AVAILABLE	NOT APPLICABLE	34566-2893	G	0	A	BLACK	<table border="1"> <tr><td>72</td><td></td><td>69</td><td>67</td><td>65</td><td>63</td><td></td><td>60</td><td></td><td>57</td><td>56</td><td></td><td>53</td></tr> <tr><td></td><td></td><td>49</td><td>47</td><td>46</td><td>44</td><td>43</td><td></td><td>40</td><td></td><td>37</td><td>36</td><td>35</td><td>33</td></tr> <tr><td></td><td>73</td><td></td><td>31</td><td>30</td><td>29</td><td>28</td><td></td><td>24</td><td></td><td>21</td><td>20</td><td></td><td>17</td></tr> <tr><td></td><td></td><td>16</td><td>15</td><td>14</td><td>13</td><td></td><td>11</td><td>10</td><td></td><td></td><td>5</td><td>4</td><td>3</td><td>2</td><td>1</td></tr> </table>	72		69	67	65	63		60		57	56		53			49	47	46	44	43		40		37	36	35	33		73		31	30	29	28		24		21	20		17			16	15	14	13		11	10			5	4	3	2	1																				
72		69	67	65	63		60		57	56		53																																																																								
		49	47	46	44	43		40		37	36	35	33																																																																							
	73		31	30	29	28		24		21	20		17																																																																							
		16	15	14	13		11	10			5	4	3	2	1																																																																					
AVAILABLE	NOT APPLICABLE	34566-2913	G	0	B	ST GRAY	<table border="1"> <tr><td></td><td></td><td></td><td>68</td><td>67</td><td></td><td>64</td><td></td><td></td><td></td><td></td><td></td><td></td><td>58</td><td></td><td></td><td></td><td></td></tr> <tr><td></td><td></td><td></td><td></td><td></td><td>46</td><td>45</td><td></td><td></td><td></td><td></td><td></td><td></td><td>38</td><td></td><td></td><td></td><td></td></tr> <tr><td></td><td>73</td><td></td><td>32</td><td></td><td>30</td><td>29</td><td>28</td><td>27</td><td></td><td></td><td></td><td></td><td>22</td><td></td><td></td><td></td><td>17</td></tr> <tr><td></td><td></td><td></td><td></td><td>15</td><td>13</td><td></td><td></td><td>10</td><td></td><td></td><td></td><td></td><td></td><td></td><td></td><td></td><td>1</td></tr> </table>				68	67		64							58										46	45							38						73		32		30	29	28	27					22				17					15	13			10									1					
			68	67		64							58																																																																							
					46	45							38																																																																							
	73		32		30	29	28	27					22				17																																																																			
				15	13			10									1																																																																			
AVAILABLE	NOT APPLICABLE	34566-2923	G	0	B	ST GRAY	<table border="1"> <tr><td></td><td></td><td></td><td>68</td><td>67</td><td></td><td>64</td><td></td><td></td><td></td><td></td><td></td><td></td><td></td><td></td><td></td><td></td><td></td></tr> <tr><td></td><td></td><td></td><td></td><td></td><td>46</td><td>45</td><td></td><td></td><td></td><td></td><td></td><td></td><td></td><td></td><td></td><td></td><td></td></tr> <tr><td></td><td>73</td><td></td><td>32</td><td></td><td>30</td><td>29</td><td>28</td><td>27</td><td></td><td></td><td></td><td></td><td></td><td></td><td></td><td></td><td>17</td></tr> <tr><td></td><td></td><td></td><td></td><td>15</td><td>13</td><td></td><td></td><td>10</td><td></td><td></td><td></td><td></td><td></td><td></td><td></td><td></td><td></td></tr> </table>				68	67		64																	46	45													73		32		30	29	28	27									17					15	13			10														
			68	67		64																																																																														
					46	45																																																																														
	73		32		30	29	28	27									17																																																																			
				15	13			10																																																																												
AVAILABLE	NOT APPLICABLE	34566-2933	G	0	A	BLACK	<table border="1"> <tr><td>72</td><td></td><td>69</td><td>67</td><td>65</td><td>63</td><td></td><td>60</td><td></td><td>57</td><td>56</td><td></td><td>53</td></tr> <tr><td></td><td></td><td>49</td><td>47</td><td></td><td>44</td><td>43</td><td></td><td>40</td><td></td><td>37</td><td>36</td><td>35</td><td>33</td></tr> <tr><td></td><td>73</td><td></td><td>31</td><td>30</td><td>29</td><td>28</td><td></td><td>24</td><td></td><td>21</td><td>20</td><td></td><td>17</td></tr> <tr><td></td><td></td><td>16</td><td>15</td><td>14</td><td></td><td></td><td>11</td><td>10</td><td></td><td></td><td></td><td>5</td><td>4</td><td>3</td><td>2</td><td>1</td></tr> </table>	72		69	67	65	63		60		57	56		53			49	47		44	43		40		37	36	35	33		73		31	30	29	28		24		21	20		17			16	15	14			11	10				5	4	3	2	1																			
72		69	67	65	63		60		57	56		53																																																																								
		49	47		44	43		40		37	36	35	33																																																																							
	73		31	30	29	28		24		21	20		17																																																																							
		16	15	14			11	10				5	4	3	2	1																																																																				
AVAILABLE	NOT APPLICABLE	34566-2943	G	0	B	ST GRAY	<table border="1"> <tr><td></td><td></td><td></td><td>68</td><td>67</td><td></td><td>64</td><td>63</td><td></td><td></td><td>59</td><td>57</td><td></td><td></td><td></td><td></td><td></td><td></td></tr> <tr><td></td><td></td><td></td><td></td><td></td><td>46</td><td>45</td><td>43</td><td></td><td></td><td>39</td><td>37</td><td></td><td></td><td></td><td></td><td></td><td></td></tr> <tr><td></td><td></td><td></td><td>32</td><td></td><td>30</td><td>29</td><td>28</td><td>27</td><td></td><td></td><td></td><td>21</td><td></td><td></td><td></td><td></td><td></td></tr> <tr><td></td><td></td><td></td><td></td><td></td><td></td><td></td><td></td><td>10</td><td></td><td></td><td></td><td>6</td><td>5</td><td>4</td><td>3</td><td></td><td></td></tr> </table>				68	67		64	63			59	57												46	45	43			39	37										32		30	29	28	27				21														10				6	5	4	3							
			68	67		64	63			59	57																																																																									
					46	45	43			39	37																																																																									
			32		30	29	28	27				21																																																																								
								10				6	5	4	3																																																																					
AVAILABLE	NOT APPLICABLE	34566-2953	G	0	B	ST GRAY	<table border="1"> <tr><td></td><td></td><td></td><td>68</td><td>67</td><td></td><td>64</td><td>63</td><td></td><td></td><td>59</td><td></td><td></td><td></td><td></td><td></td><td></td><td></td></tr> <tr><td></td><td></td><td></td><td></td><td></td><td>46</td><td>45</td><td>43</td><td></td><td></td><td>39</td><td></td><td></td><td></td><td></td><td></td><td>34</td><td></td></tr> <tr><td></td><td></td><td></td><td>32</td><td></td><td>30</td><td>29</td><td>28</td><td>27</td><td></td><td></td><td></td><td></td><td></td><td></td><td></td><td></td><td></td></tr> <tr><td></td><td></td><td></td><td></td><td></td><td></td><td></td><td></td><td>10</td><td></td><td></td><td></td><td>6</td><td>5</td><td>4</td><td>3</td><td></td><td></td></tr> </table>				68	67		64	63			59													46	45	43			39						34					32		30	29	28	27																		10				6	5	4	3							
			68	67		64	63			59																																																																										
					46	45	43			39						34																																																																				
			32		30	29	28	27																																																																												
								10				6	5	4	3																																																																					
AVAILABLE	NOT APPLICABLE	34566-2963	G	0	H	ST GRAY	<table border="1"> <tr><td></td><td>79</td><td></td><td></td><td></td><td>74</td><td>73</td><td>72</td><td>71</td><td></td><td>69</td><td>68</td><td>67</td><td></td><td></td><td>64</td><td></td><td>62</td><td>61</td></tr> <tr><td></td><td>59</td><td></td><td></td><td></td><td>54</td><td>53</td><td>52</td><td></td><td></td><td>49</td><td>48</td><td>47</td><td></td><td></td><td></td><td></td><td>42</td><td>41</td></tr> <tr><td></td><td></td><td>38</td><td></td><td></td><td></td><td></td><td>33</td><td></td><td></td><td>29</td><td>27</td><td></td><td>25</td><td></td><td></td><td></td><td></td><td>21</td></tr> <tr><td></td><td></td><td></td><td></td><td></td><td>15</td><td>14</td><td></td><td></td><td>11</td><td>10</td><td>9</td><td>8</td><td>7</td><td></td><td></td><td></td><td></td><td></td></tr> </table>		79				74	73	72	71		69	68	67			64		62	61		59				54	53	52			49	48	47					42	41			38					33			29	27		25					21						15	14			11	10	9	8	7						
	79				74	73	72	71		69	68	67			64		62	61																																																																		
	59				54	53	52			49	48	47					42	41																																																																		
		38					33			29	27		25					21																																																																		
					15	14			11	10	9	8	7																																																																							
AVAILABLE	NOT APPLICABLE	34566-2973	G	0	G	BLUE	<table border="1"> <tr><td>80</td><td>78</td><td>77</td><td>76</td><td>75</td><td>74</td><td>73</td><td>72</td><td></td><td>70</td><td>69</td><td>67</td><td></td><td>65</td><td>64</td><td>63</td><td>62</td><td></td><td></td></tr> <tr><td>60</td><td>58</td><td>57</td><td>56</td><td>55</td><td>54</td><td></td><td>52</td><td>51</td><td>50</td><td>49</td><td>47</td><td></td><td>45</td><td></td><td></td><td></td><td></td><td></td></tr> <tr><td>40</td><td>38</td><td>37</td><td></td><td></td><td></td><td></td><td>33</td><td>32</td><td>31</td><td></td><td></td><td>27</td><td>26</td><td>25</td><td>24</td><td></td><td></td><td></td></tr> <tr><td>20</td><td>18</td><td>17</td><td></td><td></td><td></td><td></td><td></td><td></td><td></td><td>10</td><td>9</td><td>8</td><td></td><td>6</td><td>5</td><td></td><td>3</td><td>2</td><td>1</td></tr> </table>	80	78	77	76	75	74	73	72		70	69	67		65	64	63	62			60	58	57	56	55	54		52	51	50	49	47		45						40	38	37					33	32	31			27	26	25	24				20	18	17								10	9	8		6	5		3	2	1
80	78	77	76	75	74	73	72		70	69	67		65	64	63	62																																																																				
60	58	57	56	55	54		52	51	50	49	47		45																																																																							
40	38	37					33	32	31			27	26	25	24																																																																					
20	18	17								10	9	8		6	5		3	2	1																																																																	

<b>ENTER DESCRIPTION</b> TEC NO: JAU2010-1551 DRAWN BY: 2010/03/15 CHKD OR FFF: 2008/05/09 APPR: VKOSHY 2010/03/18	QUALITY SYMBOLS	GENERAL TOLERANCES (UNLESS SPECIFIED)	DIMENSION STYLE	SCALE	DESIGN UNITS	THIRD ANGLE PROJECTION	
	∇=0 ∇=0 ∇=0	mm INCH 4 PLACES ± --- ± --- 3 PLACES ± --- ± --- 2 PLACES ± --- ± --- 1 PLACE ± --- ± ---	MM ONLY	2:1	METRIC	DRAWN BY: SRAJENDRANAT 2008/05/09 CHECKED BY: DATE TSK IVER 2008/05/09 APPROVED BY: DATE VKOSHY 2010/03/18	TITLE: MX123 73/80 CKT HRNS CONN ASSY
	DRAFT WHERE APPLICABLE MUST REMAIN WITHIN DIMENSIONS	SEE BOM TABLE	MATERIAL NO.	DOCUMENT NO.	MOLEX INCORPORATED SD-34566-001		SHEET NO. 34 OF 36
	THIS DRAWING CONTAINS INFORMATION THAT IS PROPRIETARY TO MOLEX INCORPORATED AND SHOULD NOT BE USED WITHOUT WRITTEN PERMISSION						

STATUS	GM PART #	MATERIAL #	PART / MATERIAL REVISION	WIRE DRESS OPTION	KEY OPTION	COLOR (TPA)	NUMBERS INDICATE CAVITIES OPEN FOR CIRCUITS																																																																																																									
AVAILABLE	NOT APPLICABLE	34566-9913	G	0	A	BLACK	<table border="1"> <tr><td>72</td><td>71</td><td></td><td></td><td>68</td><td>67</td><td>66</td><td>65</td><td>64</td><td></td><td></td><td></td><td></td><td></td><td></td><td>59</td><td></td><td></td><td></td><td></td><td></td></tr> <tr><td></td><td></td><td>50</td><td></td><td>48</td><td>47</td><td>46</td><td>45</td><td></td><td></td><td></td><td></td><td></td><td></td><td></td><td>40</td><td>39</td><td>38</td><td></td><td></td><td></td></tr> <tr><td></td><td></td><td></td><td></td><td>31</td><td>30</td><td></td><td></td><td></td><td></td><td></td><td></td><td></td><td></td><td>25</td><td>24</td><td></td><td>22</td><td>21</td><td>20</td><td></td></tr> <tr><td></td><td></td><td></td><td></td><td></td><td></td><td>14</td><td></td><td></td><td></td><td></td><td></td><td></td><td></td><td></td><td>9</td><td>7</td><td>6</td><td>5</td><td>4</td><td></td></tr> <tr><td></td><td></td><td></td><td></td><td></td><td></td><td></td><td></td><td></td><td></td><td></td><td></td><td></td><td></td><td></td><td></td><td></td><td></td><td></td><td>2</td><td>1</td></tr> </table>	72	71			68	67	66	65	64							59								50		48	47	46	45								40	39	38								31	30									25	24		22	21	20								14									9	7	6	5	4																					2	1
72	71			68	67	66	65	64							59																																																																																																	
		50		48	47	46	45								40	39	38																																																																																															
				31	30									25	24		22	21	20																																																																																													
						14									9	7	6	5	4																																																																																													
																			2	1																																																																																												
AVAILABLE	NOT APPLICABLE	34566-9923	G	0	A	BLACK	<table border="1"> <tr><td>72</td><td>71</td><td></td><td></td><td></td><td>67</td><td>66</td><td></td><td></td><td></td><td>62</td><td>61</td><td>60</td><td></td><td></td><td>57</td><td></td><td></td><td>55</td><td>54</td></tr> <tr><td></td><td>51</td><td></td><td></td><td></td><td>48</td><td>46</td><td>45</td><td>44</td><td>43</td><td>42</td><td></td><td></td><td></td><td></td><td>39</td><td></td><td></td><td></td><td>35</td><td>33</td></tr> <tr><td></td><td></td><td></td><td></td><td></td><td></td><td>15</td><td>14</td><td></td><td></td><td></td><td></td><td></td><td></td><td>8</td><td>7</td><td>6</td><td>5</td><td>4</td><td>3</td><td>2</td></tr> </table>	72	71				67	66				62	61	60			57			55	54		51				48	46	45	44	43	42					39				35	33							15	14							8	7	6	5	4	3	2																																											
72	71				67	66				62	61	60			57			55	54																																																																																													
	51				48	46	45	44	43	42					39				35	33																																																																																												
						15	14							8	7	6	5	4	3	2																																																																																												
AVAILABLE	NOT APPLICABLE	34566-9933	G	0	B	ST GRY	<table border="1"> <tr><td></td><td></td><td></td><td>69</td><td></td><td></td><td>65</td><td>64</td><td>63</td><td></td><td></td><td></td><td></td><td></td><td></td><td></td><td></td><td></td><td></td><td></td><td></td></tr> <tr><td></td><td></td><td></td><td>49</td><td></td><td></td><td>45</td><td>44</td><td>43</td><td></td><td></td><td></td><td></td><td></td><td></td><td></td><td></td><td></td><td></td><td></td><td></td></tr> <tr><td></td><td></td><td></td><td></td><td></td><td></td><td></td><td></td><td></td><td></td><td></td><td></td><td></td><td></td><td></td><td></td><td>22</td><td>21</td><td>20</td><td>19</td><td>18</td><td>17</td></tr> <tr><td></td><td></td><td></td><td></td><td></td><td></td><td></td><td></td><td></td><td></td><td></td><td></td><td></td><td></td><td></td><td></td><td>6</td><td>5</td><td>4</td><td>3</td><td>2</td><td>1</td></tr> </table>				69			65	64	63																49			45	44	43																													22	21	20	19	18	17																	6	5	4	3	2	1																			
			69			65	64	63																																																																																																								
			49			45	44	43																																																																																																								
																22	21	20	19	18	17																																																																																											
																6	5	4	3	2	1																																																																																											
AVAILABLE	NOT APPLICABLE	34566-9943	G	0	C	BLUE	<table border="1"> <tr><td></td><td>71</td><td>69</td><td></td><td></td><td>65</td><td>64</td><td></td><td></td><td>61</td><td>60</td><td></td><td></td><td>58</td><td></td><td>56</td><td>55</td><td>54</td><td></td><td></td><td></td></tr> <tr><td></td><td></td><td>50</td><td>49</td><td></td><td></td><td>45</td><td>43</td><td>41</td><td></td><td></td><td></td><td></td><td></td><td>37</td><td>36</td><td>35</td><td></td><td></td><td></td><td></td></tr> <tr><td></td><td></td><td></td><td></td><td></td><td>31</td><td>29</td><td>28</td><td></td><td></td><td>24</td><td>23</td><td></td><td></td><td></td><td></td><td>19</td><td>18</td><td>17</td><td></td><td></td></tr> <tr><td></td><td></td><td></td><td></td><td></td><td>16</td><td></td><td>13</td><td>12</td><td>11</td><td></td><td>8</td><td>7</td><td></td><td></td><td></td><td></td><td></td><td>3</td><td>2</td><td>1</td></tr> </table>		71	69			65	64			61	60			58		56	55	54						50	49			45	43	41						37	36	35										31	29	28			24	23					19	18	17								16		13	12	11		8	7						3	2	1																					
	71	69			65	64			61	60			58		56	55	54																																																																																															
		50	49			45	43	41						37	36	35																																																																																																
					31	29	28			24	23					19	18	17																																																																																														
					16		13	12	11		8	7						3	2	1																																																																																												
AVAILABLE	NOT APPLICABLE	34566-9953	G	0	A	BLACK	<table border="1"> <tr><td></td><td></td><td></td><td></td><td></td><td>67</td><td></td><td></td><td></td><td>62</td><td>60</td><td></td><td></td><td>57</td><td></td><td></td><td>55</td><td></td><td></td><td></td><td></td></tr> <tr><td></td><td></td><td></td><td></td><td></td><td>51</td><td></td><td>48</td><td>46</td><td>45</td><td>44</td><td>43</td><td></td><td></td><td></td><td>39</td><td></td><td></td><td></td><td>35</td><td></td></tr> <tr><td></td><td></td><td></td><td></td><td></td><td></td><td></td><td></td><td></td><td></td><td></td><td></td><td>25</td><td></td><td></td><td></td><td></td><td></td><td></td><td></td><td></td></tr> <tr><td></td><td></td><td></td><td></td><td></td><td></td><td></td><td></td><td></td><td></td><td></td><td></td><td></td><td></td><td>7</td><td>6</td><td>5</td><td>4</td><td>3</td><td>2</td><td>1</td></tr> </table>						67				62	60			57			55										51		48	46	45	44	43				39				35														25																							7	6	5	4	3	2	1																					
					67				62	60			57			55																																																																																																
					51		48	46	45	44	43				39				35																																																																																													
												25																																																																																																				
														7	6	5	4	3	2	1																																																																																												
AVAILABLE	NOT APPLICABLE	34566-9963	G	0	B	ST GRY	<table border="1"> <tr><td></td><td></td><td></td><td></td><td>68</td><td>67</td><td></td><td></td><td>64</td><td>63</td><td></td><td></td><td></td><td></td><td>58</td><td></td><td></td><td>55</td><td></td><td></td><td></td></tr> <tr><td></td><td></td><td></td><td></td><td></td><td></td><td></td><td>46</td><td>45</td><td>43</td><td></td><td></td><td></td><td></td><td>38</td><td></td><td></td><td>35</td><td></td><td></td><td></td></tr> <tr><td></td><td></td><td></td><td>73</td><td></td><td>32</td><td></td><td>30</td><td>29</td><td>28</td><td>27</td><td></td><td></td><td></td><td></td><td>22</td><td></td><td>19</td><td>17</td><td></td><td></td></tr> <tr><td></td><td></td><td></td><td></td><td></td><td>15</td><td></td><td>13</td><td></td><td></td><td>10</td><td></td><td></td><td></td><td></td><td></td><td></td><td></td><td></td><td></td><td>1</td></tr> </table>					68	67			64	63					58			55											46	45	43					38			35							73		32		30	29	28	27					22		19	17								15		13			10										1																					
				68	67			64	63					58			55																																																																																															
							46	45	43					38			35																																																																																															
			73		32		30	29	28	27					22		19	17																																																																																														
					15		13			10										1																																																																																												
AVAILABLE	NOT APPLICABLE	34566-9973	G	0	B	ST GRY	<table border="1"> <tr><td></td><td></td><td></td><td></td><td>68</td><td>67</td><td></td><td></td><td>64</td><td>63</td><td></td><td></td><td></td><td></td><td>58</td><td></td><td></td><td></td><td></td><td></td><td></td></tr> <tr><td></td><td></td><td></td><td></td><td></td><td></td><td></td><td>46</td><td>45</td><td>43</td><td></td><td></td><td></td><td></td><td>38</td><td></td><td></td><td></td><td></td><td></td><td></td></tr> <tr><td></td><td></td><td></td><td></td><td>32</td><td></td><td></td><td>30</td><td>29</td><td>28</td><td>27</td><td></td><td></td><td></td><td></td><td>22</td><td></td><td></td><td></td><td></td><td>17</td></tr> <tr><td></td><td></td><td></td><td></td><td></td><td>15</td><td></td><td>13</td><td></td><td></td><td>10</td><td></td><td></td><td></td><td></td><td></td><td></td><td></td><td></td><td></td><td></td></tr> </table>					68	67			64	63					58														46	45	43					38											32			30	29	28	27					22					17						15		13			10																															
				68	67			64	63					58																																																																																																		
							46	45	43					38																																																																																																		
				32			30	29	28	27					22					17																																																																																												
					15		13			10																																																																																																						

<b>ENTER DESCRIPTION</b> TEC NO: JAU2010-1551 DRAWN BY: 2010/03/15 CHKD:DRFF   HS 2008/05/09 APPR:VKOSHY 2010/03/18	QUALITY SYMBOLS ▽=0 ▽=0 ▽=0	GENERAL TOLERANCES (UNLESS SPECIFIED) <table border="1"> <tr><th></th><th>mm</th><th>INCH</th></tr> <tr><td>4 PLACES</td><td>±---</td><td>±---</td></tr> <tr><td>3 PLACES</td><td>±---</td><td>±---</td></tr> <tr><td>2 PLACES</td><td>±---</td><td>±---</td></tr> <tr><td>1 PLACE</td><td>±---</td><td>±---</td></tr> </table>		mm	INCH	4 PLACES	±---	±---	3 PLACES	±---	±---	2 PLACES	±---	±---	1 PLACE	±---	±---	DIMENSION STYLE <b>MM ONLY</b>	SCALE <b>1:1</b>	DESIGN UNITS <b>METRIC</b>	THIRD ANGLE PROJECTION 
		mm	INCH																		
	4 PLACES	±---	±---																		
	3 PLACES	±---	±---																		
2 PLACES	±---	±---																			
1 PLACE	±---	±---																			
DRAWN BY: SRAJENDRANAT 2008/05/09 CHECKED BY: TSK IVER 2008/05/09 APPROVED BY: VKOSHY 2010/03/18	DRAFT WHERE APPLICABLE MUST REMAIN WITHIN DIMENSIONS		MATERIAL NO: <b>SEE BOM TABLE</b>	DOCUMENT NO: <b>SD-34566-001</b>	TITLE <b>MX123 73/80 CKT HRNS CONN ASSY</b>	SHEET NO. <b>35 OF 36</b>															
MATERIAL NO: <b>SEE BOM TABLE</b>			DOCUMENT NO: <b>SD-34566-001</b>		TITLE <b>MX123 73/80 CKT HRNS CONN ASSY</b>																
THIS DRAWING CONTAINS INFORMATION THAT IS PROPRIETARY TO MOLEX INCORPORATED AND SHOULD NOT BE USED WITHOUT WRITTEN PERMISSION																					

