

**PLEASE CHECK WWW.MOLEX.COM FOR LATEST PART INFORMATION**

**Part Number:** **0346750003**  
**Status:** **Active**  
**Overview:** mx150 sealed connector system  
**Description:** 5.00mm (.197") Pitch MX150™ 2 Way Inline Male Assembly with TPA, Single Row, 2 Circuits, Keying Option C, with Clip Slot, Black

**Documents:**

<a href="#">3D Model</a>	<a href="#">Product Specification PS-34062-000 (PDF)</a>
<a href="#">Application Specification (PDF)</a>	<a href="#">RoHS Certificate of Compliance (PDF)</a>
<a href="#">Drawing (PDF)</a>	

**General**

Product Family	Crimp Housings
Series	34675
Comments	With Clipslot
More Detailed Tech Information	<a href="http://ewcap.uscarteams.org">http://ewcap.uscarteams.org</a>
Overview	<u>mx150 sealed connector system</u>
Product Name	MX150™

**Physical**

Circuits (maximum)	2
Circuits Detail	2
Color - Resin	Black
Gender	Male
Glow-Wire Compliant	No
Keying to Mating Part	Yes
Lock to Mating Part	Yes
Material - Resin	Nylon
Number of Rows	2
Packaging Type	Bag
Panel Mount	No
Pitch - Mating Interface (in)	0.197 In
Pitch - Mating Interface (mm)	5.00 mm
Pitch - Term. Interface (in)	0.197 In
Pitch - Term. Interface (mm)	5.00 mm
Polarized to Mating Part	Yes
Stackable	No
Temperature Range - Operating	-40°C to +120°C

**Electrical**

Current - Maximum per Contact	22A
-------------------------------	-----

**Material Info**

**Reference - Drawing Numbers**

Application Specification	AS-34062-000
Packaging Specification	PK-31300-635
Product Specification	PS-34062-000
Sales Drawing	SD-34675-001



**EU RoHS**

**ELV and RoHS Compliant**  
**REACH SVHC Contains SVHC: No**  
**Halogen-Free Status**  
**Not Reviewed**

**China RoHS**



**Need more information on product environmental compliance?**

Email [productcompliance@molex.com](mailto:productcompliance@molex.com)  
 For a multiple part number RoHS Certificate of Compliance, [click here](#)

Please visit the [Contact Us](#) section for any non-product compliance questions.

**Search Parts in this Series**

[34675Series](#)

**Mates With**

[340620023](#) MX150™ Sealed Female Receptacle

**Use With**

[34080](#) Male Terminal

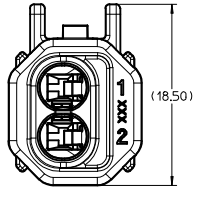

KEY OPTION C

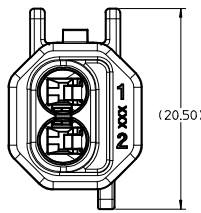

KEY OPTION B

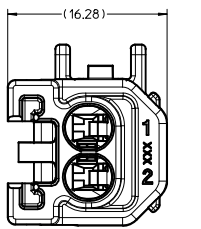

KEY OPTION C W/CLIP SLOT

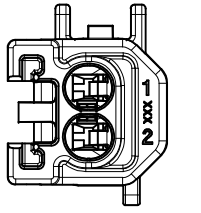

KEY OPTION B W/CLIP SLOT

TERMINAL INFORMATION 1.5 MM CABLE SEAL BLADE				CABLE SEAL INFORMATION			
TERMINAL PART NUMBER	GRIP SIZE	PLATING	PAYOFF DIRECTION	OSR PART NUMBER	YAZAKI PART NUMBER	COLOR	WIRE OD RANGE
34080-0001	14	TIN	RIGHT	-	7158-3033-40	GRAY	2.54 - 2.69
34080-1001	14	TIN	LEFT	-	7158-3033-40	GRAY	2.54 - 2.69
34080-0001	16	TIN	RIGHT	E-1644-02	-	YELLOW	2.18 - 2.40
34080-1001	16	TIN	LEFT	E-1644-02	-	YELLOW	2.18 - 2.40
34080-0002	18/20	TIN	RIGHT	E-1644-00	-	GREEN	1.70 - 2.10
34080-1002	18/20	TIN	LEFT	E-1644-00	-	GREEN	1.70 - 2.10
34080-0003	22	TIN	RIGHT	E-1644-01	-	PINK	1.40 - 1.65
34080-1003	22	TIN	LEFT	E-1644-01	-	PINK	1.40 - 1.65

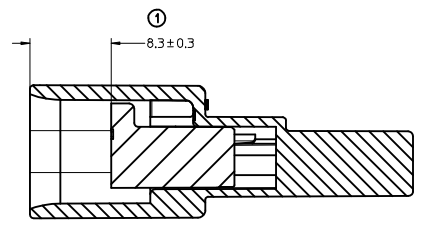

SECTION A-A  
TPA SHOWN IN PRE-LOCK POSITION

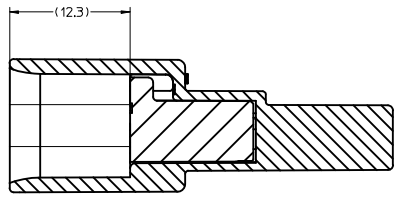

SECTION A-A  
TPA SHOWN IN FINAL LOCK POSITION

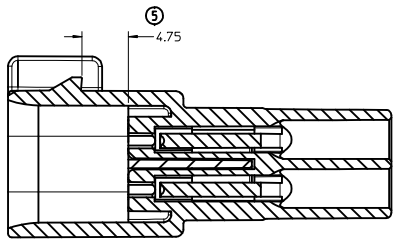
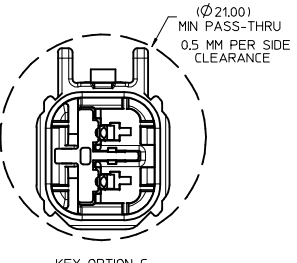
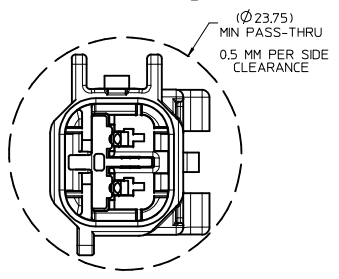
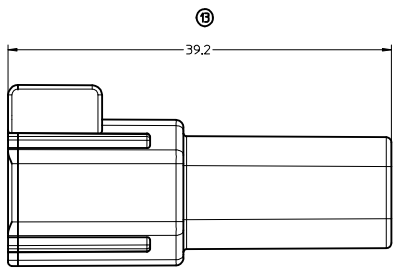
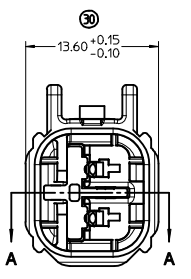
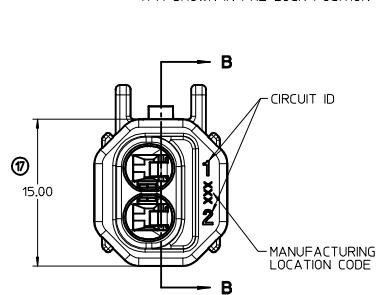

SECTION B-B

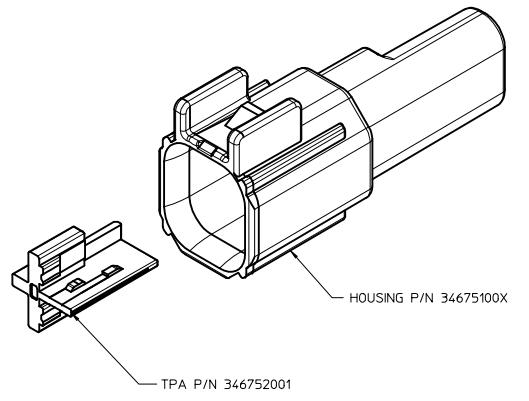

- NOTES: UNLESS OTHERWISE SPECIFIED
- PART MUST CONFORM TO SAE/USCAR-2 REV. 4 CLASS 3 EXCEPTIONS:  
a) THE FORCE TO MOVE THE TPA FROM FINAL-LOCK TO PRE-LOCK SHALL NOT BE LESS THAN 12 N  
b) POLARIZATION FEATURE EFFECTIVENESS: CONFORMS TO USCAR-2 REV 5
  - MATERIAL: HOUSING & TPA NYLON 6 30% GLASS FILLED.
  - SHALL CONFORM TO PRODUCT SPECIFICATION PS-34675-000
  - SHALL CONFORM TO PACKAGING SPECIFICATION PK-31300-635
  - ASSEMBLY SHIPPED WITH TPA IN PRE-LOCK POSITION (SEE SECTION A-A PRE-LOCK), UPON FULL TERMINAL ASSEMBLY, EACH TPA MUST BE SNAPPED INTO ITS FINAL-LOCK POSITION.
  - DESIGNED TO MATE WITH RECEPTACLE ASSEMBLY SPECIFIED IN CHART.
  - FOR BLADE TERMINALS TO BE USED WITH THIS ASSEMBLY SEE CHART. TERMINAL SALES DRAWING NUMBER: 34080-001

ASSEMBLY NUMBER	KEY OPTION	COLOR	CLIPSLOT	MATING RECEPTACLE ASSEMBLY PART NUMBER
34675-0001	C	BLACK	NO	34062-0023/34062-0033
34675-0002	B	GRAY	NO	34062-0022/34062-0032
34675-0003	C	BLACK	YES	34062-0023/34062-0033
34675-0004	B	GRAY	YES	34062-0022/34062-0032

<b>ENTER DESCRIPTION</b> EC NO. JAU2009-0045 DRAWN BY M. VANSIAMBRO 2008/07/15 CHKD BY S. VERZYL 2008/07/16 APPR. BY KYOSHI 2008/07/16	<b>QUALITY SYMBOLS</b> ▽=0 ▽=0	<b>GENERAL TOLERANCES (UNLESS SPECIFIED)</b>		<b>DIMENSION STYLE</b> MM ONLY		SCALE 4:1	DESIGN UNITS METRIC	THIRD ANGLE PROJECTION	
		4 PLACES ± --- ± --- 3 PLACES ± --- ± --- 2 PLACES ± 0.10 ± --- 1 PLACE ± 0.2 ± ---	mm INCH ± --- ± --- ± --- ± --- ± --- ± ---	APPROVED BY DATE S. MARCEAU		TITLE 2 WAY INLINE MALE ASSEMBLY		MATERIAL NO. DOCUMENT NO. SEE CHART SD-34675-001	
		DRAFT WHERE APPLICABLE MUST REMAIN WITHIN DIMENSIONS		MOLEX INCORPORATED		SHEET NO. 1 OF 1			