

**PLEASE CHECK WWW.MOLEX.COM FOR LATEST PART INFORMATION**

**Part Number:** [0395433102](#)  
**Status:** **Active**  
**Description:** 5.00mm (.197") Pitch Eurostyle™ Horizontal Fixed Mount PCB Terminal Block, 2 Circuits

**Documents:**

[3D Model](#)  
[Drawing \(PDF\)](#)

[RoHS Certificate of Compliance \(PDF\)](#)

**General**

Product Family	Terminal Blocks
Series	<a href="#">39543</a>
Application	Wire-to-Board
Component Type	One Piece
Product Literature Order No	USA-355
Product Name	ESE, Eurostyle™ Fixed Mount
Type	Euro Block

**Physical**

Circuits (Loaded)	2
Entry Angle	Vertical
Lock to Mating Part	None
Number of Rows	1
Orientation	Horizontal
PC Tail Length (in)	0.138 In
PC Tail Length (mm)	3.50 mm
PCB Thickness Recommended (in)	0.098 In
PCB Thickness Recommended (mm)	2.50 mm
Panel Mount	No
Pitch - Mating Interface (in)	0.197 In
Pitch - Mating Interface (mm)	5.00 mm
Polarized to Mating Part	N/A
Stackable	No
Temperature Range - Operating	-40°C to +105°C
Wire Size AWG	16, 18, 20, 22, 24
Wire Size mm²	0.20 - 1.31

**Electrical**

Current - Maximum per Contact	10A
Voltage - Maximum	300V

**Solder Process Data**

Duration at Max. Process Temperature (seconds)	5
Lead-free Process Capability	Wave Capable (TH only)
Max. Cycles at Max. Process Temperature	135
Process Temperature max. C	260

**Material Info**

**Reference - Drawing Numbers**

Sales Drawing SD-39501-002, SD-39543-006

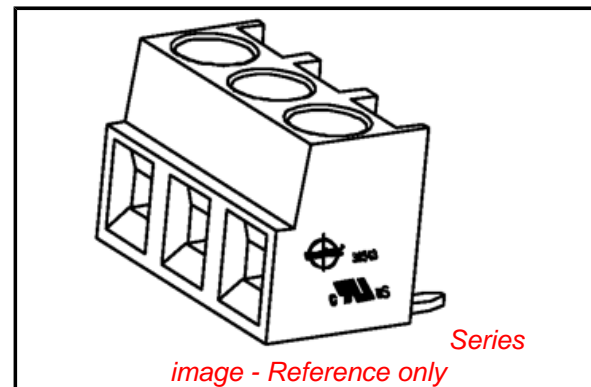

*image - Reference only*

**EU RoHS**

**ELV and RoHS Compliant**  
**REACH SVHC**  
 Not Reviewed  
**Halogen-Free Status**

**China RoHS**



**Not Reviewed**

**Need more information on product environmental compliance?**

Email [productcompliance@molex.com](mailto:productcompliance@molex.com)  
 For a multiple part number RoHS Certificate of Compliance, [click here](#)

Please visit the [Contact Us](#) section for any non-product compliance questions.

**Search Parts in this Series**

[39543Series](#)

3950X SERIES  
3.50mm HEADERS

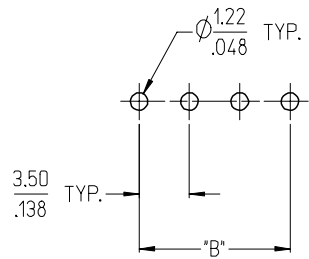

3952X & 3954X SERIES  
5.00mm HEADERS  
5.00mm 10 AMP FIXED

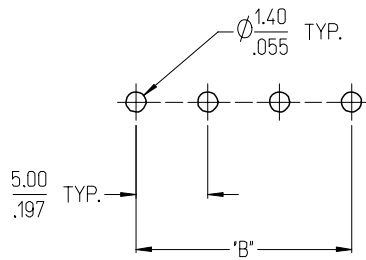

3953X SERIES  
5.08mm HEADERS

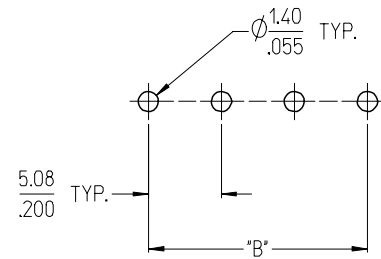

3951X SERIES  
3.81mm HEADERS

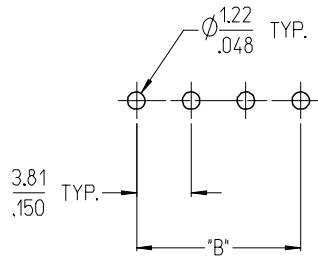

3954X SERIES  
5.00mm 15 AMP FIXED

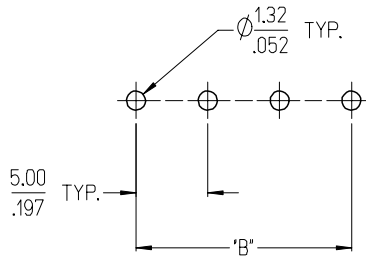

3954X SERIES  
5.08mm 15 AMP FIXED

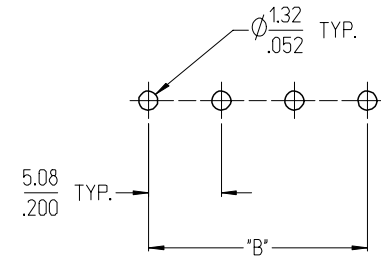

NOTES:

- REFER TO INDIVIDUAL PRODUCT SALES DRAWINGS FOR "B" DIMENSION.
- DOES NOT APPLY TO DUAL LEVEL HEADERS, SERIES 39528 AND 39538.
- TYP. = TYPICAL.

INITIAL RELEASE  
EC NO: ETC2007-0096  
DRAWN: CLYORK 2006/10/02  
CHKD: JMACNEIL 2006/10/04  
APPR: JMACNEIL 2006/10/04

QUALITY SYMBOLS

GENERAL TOLERANCES (UNLESS SPECIFIED)	
	MM/IN
4 PLACES	± .005 / ± .002
3 PLACES	± .005 / ± .002
2 PLACES	± 0.13 / ± .01
1 PLACE	± 0.3 / ± .01
ANGULAR ± 2 °	

DIMENSION STYLE	
MM/IN	
DRAWN BY	DATE
C. YORK	2006/08/25
CHECKED BY	DATE
J. MACNEIL	2006/08/25
APPROVED BY	DATE
J. MACNEIL	2006/08/25
MATERIAL NO.	
--	

SCALE	DESIGN UNITS	THIRD ANGLE PROJECTION
3:1	INCH	
TITLE		
RECOMMENDED PCB LAYOUT FOR ESE TERMINAL BLOCKS		
APPROVED BY		
J. MACNEIL		
DATE		
2006/08/25		
MATERIAL NO.		
SD-39501-002		
SHEET NO.		
1 OF 1		

10 9 8 7 6 5 4 3 2 1

F  
E  
D  
C  
B  
A

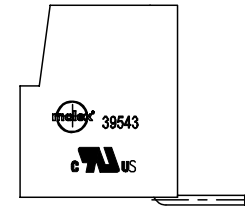
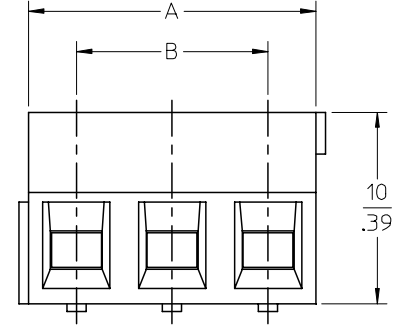
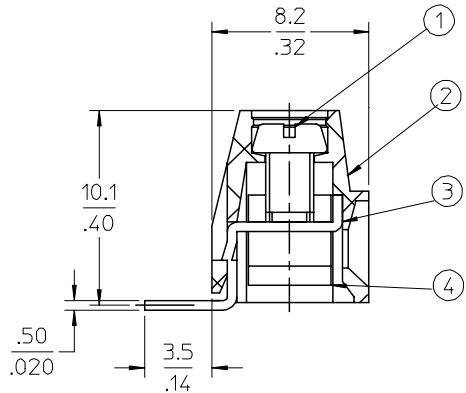
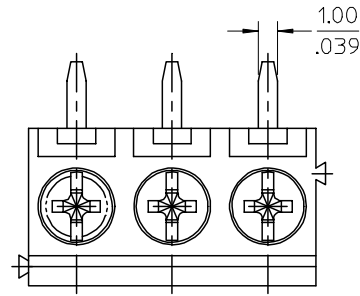
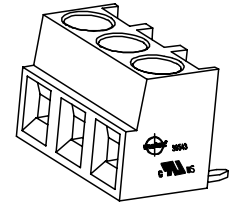

- NOTES:  
SPECIFICATIONS:
- Material:
    - Screw: C1010,
    - Body: PA66
    - Terminal: Brass
    - Cage: Brass
  - Wire range: 24 - 16AWG.
  - Electrical rating: 300V, 10A.
  - MAX TORQUE: 3.5 in-lbs.
  - Wire strip length: 5.5mm.
  - Dielectric withstands: AC2500V for 1 minute.
  - Breakdown voltage: 4000v(1.2/50us), 5 times.
  - Insulation resistance: DC500V, 1000M.
  - Operating temperature: -40C to +105C.
  - A = N x P.
  - B = (N - 1) x P
  - P = (Pitch) = 5.00MM (.197").
  - N = Number of positions available 2 through 24.

ENTER DESCRIPTION EC NO: NEO2006-0310 DRWNL:ROTHAUS 2006/01/09 CHKD:CYORK 2006/01/09 APPR:JPAMLIK 2006/01/10 DESCRIPTION	QUALITY SYMBOLS	GENERAL TOLERANCES (UNLESS SPECIFIED)	DIMENSION STYLE	SCALE	DESIGN UNITS	THIRD ANGLE PROJECTION															
	$\nabla=0$ $\nabla=0$	<table border="1"> <thead> <tr> <th></th> <th>mm</th> <th>INCH</th> </tr> </thead> <tbody> <tr> <td>4 PLACES</td> <td>± ---</td> <td>±.0015</td> </tr> <tr> <td>3 PLACES</td> <td>±0.038</td> <td>±.005</td> </tr> <tr> <td>2 PLACES</td> <td>±0.13</td> <td>±.01</td> </tr> <tr> <td>1 PLACE</td> <td>±0.3</td> <td>± ---</td> </tr> </tbody> </table>		mm	INCH	4 PLACES	± ---	±.0015	3 PLACES	±0.038	±.005	2 PLACES	±0.13	±.01	1 PLACE	±0.3	± ---	MM/IN	4:1	INCH	
		mm	INCH																		
	4 PLACES	± ---	±.0015																		
3 PLACES	±0.038	±.005																			
2 PLACES	±0.13	±.01																			
1 PLACE	±0.3	± ---																			
	DRAWN BY: LROTHAUS CHECKED BY: C. YORK APPROVED BY:	DATE: 12/6/05 DATE: 01/06/06 DATE:	TITLE: 5.0MM, EURO TERM BLOCK RIGHT ANGLE, PC MOUNT STACKABLE, STAMPED TERM																		
REV A		DRAFT WHERE APPLICABLE MUST REMAIN WITHIN DIMENSIONS	MATERIAL NO.: SEE CHART SIZE B	DOCUMENT NO.: SD-39543-006	MOLEX INCORPORATED SHEET NO. 1 OF 1																

9 8 7 6 5 4 3 2 1

Description	Circuit size	Material Numbers Molded to Length						Material Numbers Stackable						Dimensional Information				
		Black			Green			Black			Green							
		100% Tin						100% Tin										
		Printing Options		Printing Options		Printing Options		Printing Options		Printing Options		Printing Options		Dim A		Dim B		
None	10A	11A	None	10A	11A	None	10A	11A	None	10A	11A	None	10A	11A	mm	inch	mm	inch
5.0mm, Euro Block, PC Mount, Right Angle	2	395433102	395435102	395437102	395933102	395935102	395937102	395434502	395436502	395438502	395934502	395936502	395938502	10.00	0.394	5.00	0.197	
5.0mm, Euro Block, PC Mount, Right Angle	3	395433103	395435103	395437103	395933103	395935103	395937103	395434503	395436503	395438503	395934503	395936503	395938503	15.00	0.591	10.00	0.394	
5.0mm, Euro Block, PC Mount, Right Angle	4	395433104	395435104	395437104	395933104	395935104	395937104	N/A	N/A	N/A	N/A	N/A	N/A	20.00	0.787	15.00	0.591	
5.0mm, Euro Block, PC Mount, Right Angle	5	395433105	395435105	395437105	395933105	395935105	395937105	N/A	N/A	N/A	N/A	N/A	N/A	25.00	0.984	20.00	0.787	
5.0mm, Euro Block, PC Mount, Right Angle	6	395433106	395435106	395437106	395933106	395935106	395937106	N/A	N/A	N/A	N/A	N/A	N/A	30.00	1.181	25.00	0.984	
5.0mm, Euro Block, PC Mount, Right Angle	7	395433107	395435107	395437107	395933107	395935107	395937107	N/A	N/A	N/A	N/A	N/A	N/A	35.00	1.378	30.00	1.181	
5.0mm, Euro Block, PC Mount, Right Angle	8	395433108	395435108	395437108	395933108	395935108	395937108	N/A	N/A	N/A	N/A	N/A	N/A	40.00	1.575	35.00	1.378	
5.0mm, Euro Block, PC Mount, Right Angle	9	395433109	395435109	395437109	395933109	395935109	395937109	N/A	N/A	N/A	N/A	N/A	N/A	45.00	1.772	40.00	1.575	
5.0mm, Euro Block, PC Mount, Right Angle	10	395433110	395435110	395437110	395933110	395935110	395937110	N/A	N/A	N/A	N/A	N/A	N/A	50.00	1.969	45.00	1.772	
5.0mm, Euro Block, PC Mount, Right Angle	11	395433111	395435111	395437111	395933111	395935111	395937111	N/A	N/A	N/A	N/A	N/A	N/A	55.00	2.165	50.00	1.969	
5.0mm, Euro Block, PC Mount, Right Angle	12	395433112	395435112	395437112	395933112	395935112	395937112	N/A	N/A	N/A	N/A	N/A	N/A	60.00	2.362	55.00	2.165	
5.0mm, Euro Block, PC Mount, Right Angle	13	395433113	395435113	395437113	395933113	395935113	395937113	N/A	N/A	N/A	N/A	N/A	N/A	65.00	2.559	60.00	2.362	
5.0mm, Euro Block, PC Mount, Right Angle	14	395433114	395435114	395437114	395933114	395935114	395937114	N/A	N/A	N/A	N/A	N/A	N/A	70.00	2.756	65.00	2.559	
5.0mm, Euro Block, PC Mount, Right Angle	15	395433115	395435115	395437115	395933115	395935115	395937115	N/A	N/A	N/A	N/A	N/A	N/A	75.00	2.953	70.00	2.756	
5.0mm, Euro Block, PC Mount, Right Angle	16	395433116	395435116	395437116	395933116	395935116	395937116	N/A	N/A	N/A	N/A	N/A	N/A	80.00	3.150	75.00	2.953	
5.0mm, Euro Block, PC Mount, Right Angle	17	395433117	395435117	395437117	395933117	395935117	395937117	N/A	N/A	N/A	N/A	N/A	N/A	85.00	3.346	80.00	3.150	
5.0mm, Euro Block, PC Mount, Right Angle	18	395433118	395435118	395437118	395933118	395935118	395937118	N/A	N/A	N/A	N/A	N/A	N/A	90.00	3.543	85.00	3.346	
5.0mm, Euro Block, PC Mount, Right Angle	19	395433119	395435119	395437119	395933119	395935119	395937119	N/A	N/A	N/A	N/A	N/A	N/A	95.00	3.740	90.00	3.543	
5.0mm, Euro Block, PC Mount, Right Angle	20	395433120	395435120	395437120	395933120	395935120	395937120	N/A	N/A	N/A	N/A	N/A	N/A	100.00	3.937	95.00	3.740	
5.0mm, Euro Block, PC Mount, Right Angle	21	395433121	395435121	395437121	395933121	395935121	395937121	N/A	N/A	N/A	N/A	N/A	N/A	105.00	4.134	100.00	3.937	
5.0mm, Euro Block, PC Mount, Right Angle	22	395433122	395435122	395437122	395933122	395935122	395937122	N/A	N/A	N/A	N/A	N/A	N/A	110.00	4.331	105.00	4.134	
5.0mm, Euro Block, PC Mount, Right Angle	23	395433123	395435123	395437123	395933123	395935123	395937123	N/A	N/A	N/A	N/A	N/A	N/A	115.00	4.528	110.00	4.331	
5.0mm, Euro Block, PC Mount, Right Angle	24	395433124	395435124	395437124	395933124	395935124	395937124	N/A	N/A	N/A	N/A	N/A	N/A	120.00	4.724	115.00	4.528	

SEE SHEET 1 EC NO: NEC02006-0310 DRWNL: LROTHAUS 2006/01/09 CHKDC: CYORK 2006/01/09 APPR: J.PAWLIK 2006/01/10	QUALITY SYMBOLS ▽=0 ▽=0	GENERAL TOLERANCES (UNLESS SPECIFIED)		DIMENSION STYLE		SCALE	DESIGN UNITS	THIRD ANGLE PROJECTION
		mm	INCH	MM/IN		4:1	INCH	
		4 PLACES ± ---	± .0015	DRAWN BY	DATE	TITLE		
		3 PLACES ± 0.038	± .005	LROTHAUS	12/6/05	5.0MM, EURO TERM. BLOCK RIGHT ANGLE, PC MOUNT, STACKABLE, STAMPED TERM.		
2 PLACES ± 0.13	± .01	CHECKED BY	DATE	MATERIAL NO.		DOCUMENT NO.	SHEET NO.	
1 PLACE ± 0.3	± ---	C. YORK	01/06/06	SEE CHART		SD-39543-006	2 OF 2	
ANGULAR ± 2 °		APPROVED BY	DATE	THIS DRAWING CONTAINS INFORMATION THAT IS PROPRIETARY TO MOLEX INCORPORATED AND SHOULD NOT BE USED WITHOUT WRITTEN PERMISSION				