

**PLEASE CHECK WWW.MOLEX.COM FOR LATEST PART INFORMATION**

**Part Number:** **0877591214**  
**Status:** **Active**  
**Overview:** milligrd  
**Description:** 2.00mm (.079") Pitch Milli-Grid™ Header, Surface Mount, Vertical, 12 Circuits, 0.38µm (15µ") Gold (Au) Selective Plating, without Press-fit Plastic Pegs, Lead-free

**Documents:**

[3D Model](#) [Product Specification PS-87761-100 \(PDF\)](#)  
[Drawing \(PDF\)](#) [RoHS Certificate of Compliance \(PDF\)](#)

**Agency Certification**

UL E29179

**General**

Product Family PCB Headers  
 Series [87759](#)  
 Application Board-to-Board  
 Overview [milligrd](#)  
 Product Name Milli-Grid™

**Physical**

Breakaway Yes  
 Circuits (Loaded) 12  
 Circuits (maximum) 12  
 Color - Resin Black  
 Durability (mating cycles max) 100  
 First Mate / Last Break No  
 Flammability 94V-0  
 Glow-Wire Compliant No  
 Guide to Mating Part No  
 Keying to Mating Part None  
 Lock to Mating Part None  
 Mated Height (in) 0.150 In  
 Mated Height (mm) 3.80 mm  
 Material - Metal Phosphor Bronze  
 Material - Plating Mating Gold  
 Material - Plating Termination Tin  
 Material - Resin Nylon  
 Number of Rows 2  
 Orientation Vertical  
 PCB Locator No  
 PCB Retention None  
 Packaging Type Tube  
 Pitch - Mating Interface (in) 0.079 In  
 Pitch - Mating Interface (mm) 2.00 mm  
 Pitch - Term. Interface (in) 0.079 In  
 Pitch - Term. Interface (mm) 2.00 mm  
 Plating min: Mating (µin) 15  
 Plating min: Mating (µm) 0.38  
 Polarized to Mating Part No  
 Polarized to PCB No  
 Shrouded No  
 Stackable No  
 Temperature Range - Operating -55°C to +105°C  
 Termination Interface: Style Surface Mount

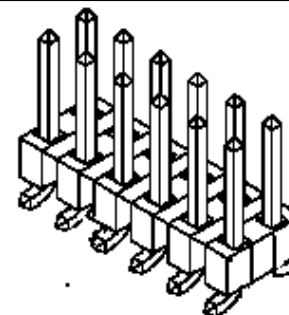

Series

image - Reference only

**EU RoHS**

**ELV and RoHS Compliant**  
**REACH SVHC Contains SVHC: No**  
**Halogen-Free Status**

**China RoHS**



**Need more information on product environmental compliance?**

Email [productcompliance@molex.com](mailto:productcompliance@molex.com)  
 For a multiple part number RoHS Certificate of Compliance, [click here](#)

Please visit the [Contact Us](#) section for any non-product compliance questions.

**Search Parts in this Series**

[87759Series](#)

**Mates With**

[79107](#) Milli-Grid™ Receptacle, Vertical, Through Hole. [79108](#) Milli-Grid™ Flex-to-Board, Vertical Receptacle. Milli-Grid™ Receptacle, Surface Mount. [79109](#). [87381](#)

**Electrical**

Current - Maximum per Contact	2A
Voltage - Maximum	125V

**Solder Process Data**

Duration at Max. Process Temperature (seconds)	10
Lead-free Process Capability	Reflow Capable (SMT only)
Max. Cycles at Max. Process Temperature	3
Process Temperature max. C	260

**Material Info****Reference - Drawing Numbers**

Packaging Specification	PK-89990-475
Product Specification	PS-87761-100
Sales Drawing	SD-87759-117

This document was generated on 05/25/2010

**PLEASE CHECK [WWW.MOLEX.COM](http://WWW.MOLEX.COM) FOR LATEST PART INFORMATION**

F

E

D

C

B

A

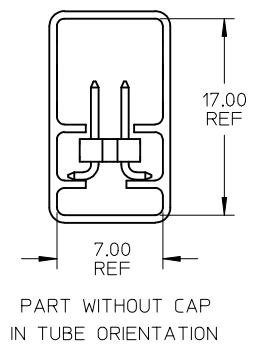
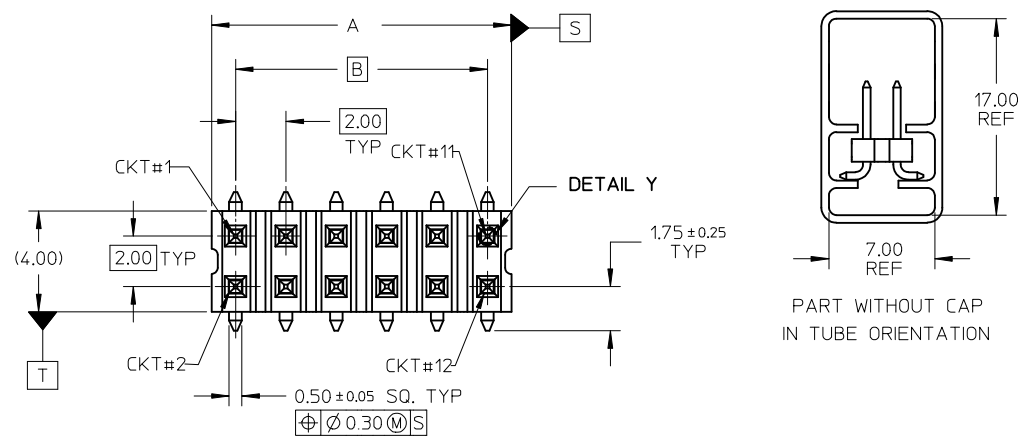

NOTE:

1. MATERIAL:  
HSG & CAP - NYLON, GLASS FILLED  
UL 94V-0, COLOUR BLACK
- PIN - 0.50 SQ PHOSPHOR BRONZE
2. PLATING:  
0.38um MIN GOLD PLATE AT CONTACT AREA,  
TIN PLATE AT SOLDER AREA,  
BOTH OVER NICKEL UNDERPLATE
3. PIN PUSHOUT FORCE: 1KG MIN IN EITHER DIRECTION
4. PRODUCT SPEC PS-87761-100 APPLIES.
- 5 BEND DEPRESSION IS ACCEPTABLE SO LONG AS IT DOES NOT AFFECT THE OVERALL COPLANARITY OF TAIL.
- 6 COPLANARITY IS TO BE MEASURED BY RESTING THE SOLDER TAIL ON A FLAT SURFACE.
- 7 CAP TO BE LOCATED AS CENTRAL OF PART AS POSSIBLE  
TOP SURFACE OF CAP TO BE FLAT FOR THE PURPOSE OF PICK & PLACE BY VACUUM SUCTION NOZZLE.
8. FOR ILLUSTRATION PURPOSES, 12CKT IS SHOWN.
- 9 CKT 4 & 6 IS CUT FROM CKT 8 & 12 RESPECTIVELY  
ROUGH EDGES ARE EXPECTED ALONG THE CUTTING EDGES.
- 10 PART TO BE PACKED IN TRAY ONLY.
11. TUBE LENGTH IS 560MM REF STANDARD.

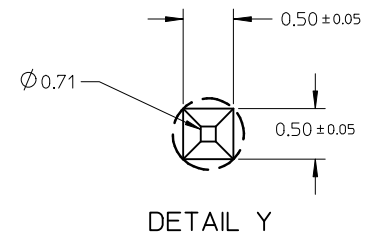
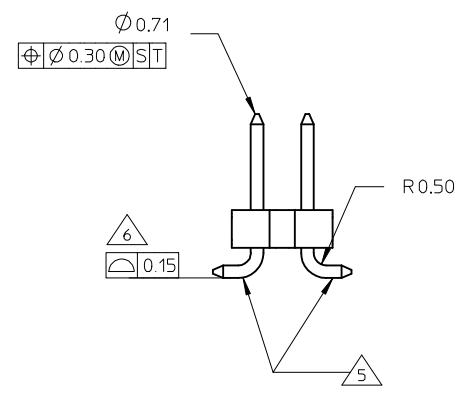
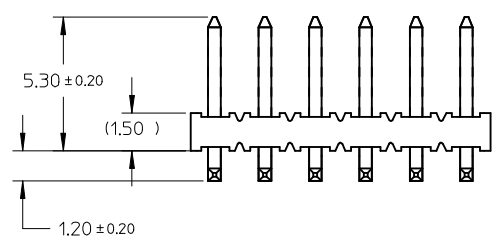

ADD. OPTION EC NO: S2009-0510 DRWN:ATSEE 2009/01/23 CHKD:SKANG 2009/02/09 APPR:MLONG 2009/02/17	QUALITY SYMBOLS ▽=0 ◻=0	GENERAL TOLERANCES (UNLESS SPECIFIED)		DIMENSION STYLE MM ONLY	SCALE NTS	DESIGN UNITS METRIC	THIRD ANGLE PROJECTION		
		mm	INCH	DRAWN BY	DATE	TITLE			
		4 PLACES	± ---	± ---	KSEE	2003/12/12	CUSTOM HEADER		
		3 PLACES	± ---	± ---	CHECKED BY	DATE	MGRID, 2MM DUAL ROW HDR.		
2 PLACES	± 0.2	± ---	KCL ING	2004/01/12	SMT				
1 PLACE	± ---	± ---	APPROVED BY	DATE	MOLEX INCORPORATED				
ANGULAR ± 3 °				SKTOH	2004/01/12	DOCUMENT NO.			
DRAFT WHERE APPLICABLE MUST REMAIN WITHIN DIMENSIONS				SEE TABLE		SD-87759-117			
				SIZE	THIS DRAWING CONTAINS INFORMATION THAT IS PROPRIETARY TO MOLEX INCORPORATED AND SHOULD NOT BE USED WITHOUT WRITTEN PERMISSION				
				A3	SHEET NO.				
						1 OF 6			

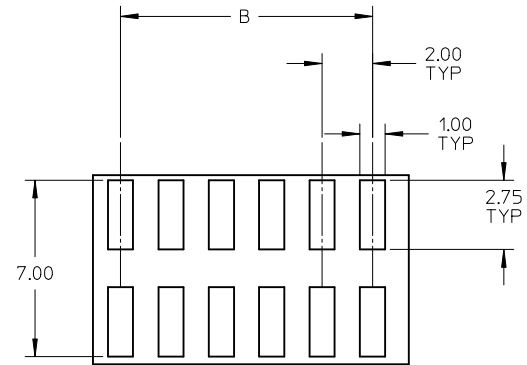
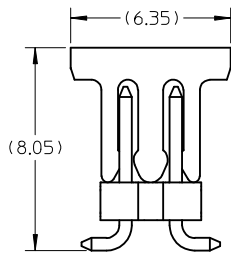
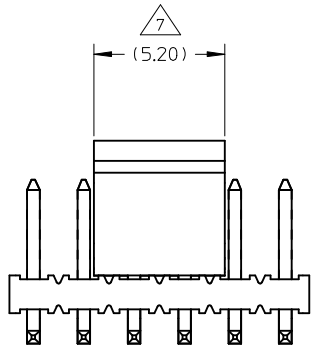

RECOMMENDED SOLDER PAD LAYOUT

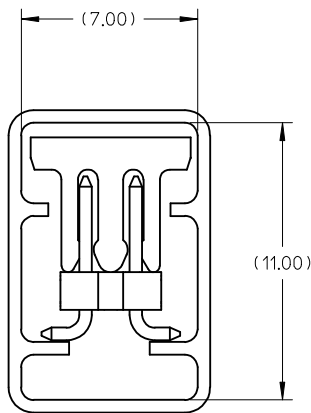
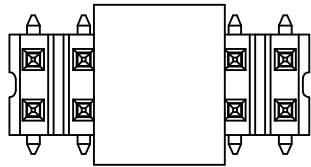

ADD. OPTION EC NO: S2009-0510 DRWN:ATSEE 2009/01/23 CHKD:SKANG 2009/02/09 APPR:MLONG 2009/02/17	QUALITY SYMBOLS ▽=0 ◻=0	GENERAL TOLERANCES (UNLESS SPECIFIED)		DIMENSION STYLE MM ONLY	SCALE NTS	DESIGN UNITS METRIC	THIRD ANGLE PROJECTION																
		<table border="1"> <thead> <tr> <th></th> <th>mm</th> <th>INCH</th> </tr> </thead> <tbody> <tr> <td>4 PLACES</td> <td>± ---</td> <td>± ---</td> </tr> <tr> <td>3 PLACES</td> <td>± ---</td> <td>± ---</td> </tr> <tr> <td>2 PLACES</td> <td>± 0.2</td> <td>± ---</td> </tr> <tr> <td>1 PLACE</td> <td>± ---</td> <td>± ---</td> </tr> </tbody> </table>		mm	INCH	4 PLACES	± ---	± ---	3 PLACES	± ---	± ---	2 PLACES	± 0.2	± ---	1 PLACE	± ---	± ---	DRAWN BY KSEE	DATE 2003/12/12	TITLE CUSTOM HEADER MGRID, 2MM DUAL ROW HDR. SMT			
		mm	INCH																				
	4 PLACES	± ---	± ---																				
3 PLACES	± ---	± ---																					
2 PLACES	± 0.2	± ---																					
1 PLACE	± ---	± ---																					
	ANGULAR ± 3 °	CHECKED BY KCLING	DATE 2004/01/12	MOLEX INCORPORATED																			
B2	DESCRIPTION REV	DRAFT WHERE APPLICABLE MUST REMAIN WITHIN DIMENSIONS		APPROVED BY SKTOH	DATE 2004/01/12	MATERIAL NO. SEE TABLE	DOCUMENT NO. SD-87759-117	SHEET NO. 2 OF 6															

EMBOSSED CARRIER TAPE TYPE "A"

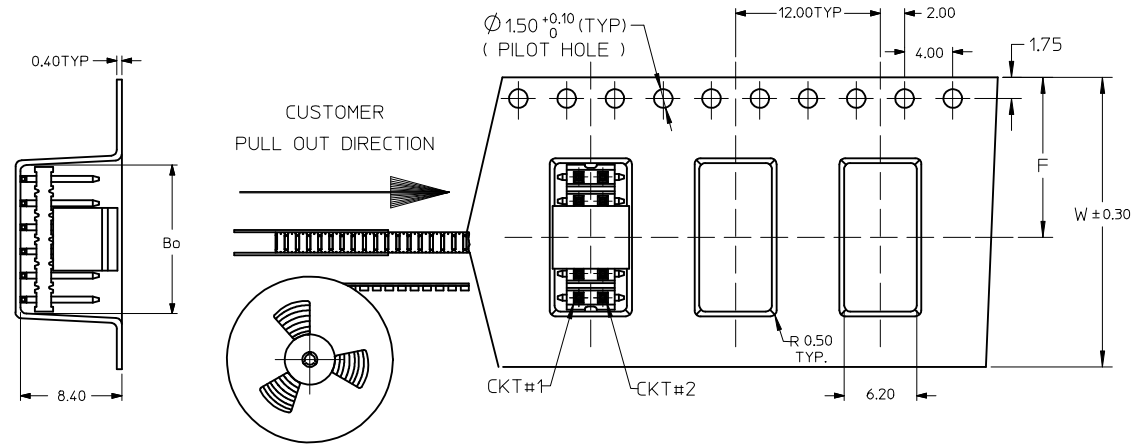

NOTES:

12. LEADER AND TRAILER TAPE

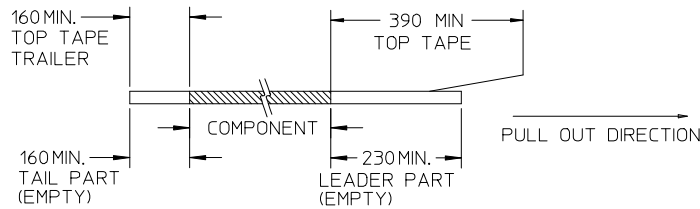

13. PEELING OFF FORCE OF THE TOP TAPE: 20-80gf.  
(PEELING DIRECTION AS SHOWN IN FOLLOWING FIGURE)

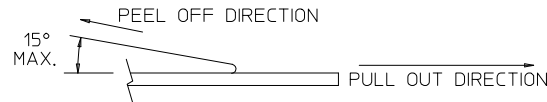

14. PACKAGING STANDARD IS AS PER EIA-481.

15. TAPE & REEL QUANTITY = 750 PCS/REEL

16. THE TAPE IS TREATED FOR ANTI-STATIC

ADD. OPTION EC NO: S2009-0510 DRWN:ATSEE 2009/01/23 CHKD:SKANG 2009/02/09 APPR:MLONG 2009/02/17 REV B2	QUALITY SYMBOLS ▽=0 ▽=0	GENERAL TOLERANCES (UNLESS SPECIFIED) mm INCH 4 PLACES ± --- ± --- 3 PLACES ± --- ± --- 2 PLACES ± 0.2 ± --- 1 PLACE ± --- ± --- ANGULAR ± 3 °	DIMENSION STYLE MM ONLY DRAWN BY: KSEE CHECKED BY: KCLING APPROVED BY: SKTOH DATE: 2003/12/12 DATE: 2004/01/12 DATE: 2004/01/12	SCALE NTS DESIGN UNITS METRIC THIRD ANGLE PROJECTION	TITLE CUSTOM HEADER MGRID, 2MM DUAL ROW HDR. SMT MOLEX INCORPORATED DOCUMENT NO. SD-87759-117 SHEET NO. 3 OF 6	
	DRAFT WHERE APPLICABLE MUST REMAIN WITHIN DIMENSIONS	SIZE A3	THIS DRAWING CONTAINS INFORMATION THAT IS PROPRIETARY TO MOLEX INCORPORATED AND SHOULD NOT BE USED WITHOUT WRITTEN PERMISSION			

EMBOSSED CARRIER TAPE TYPE "B"

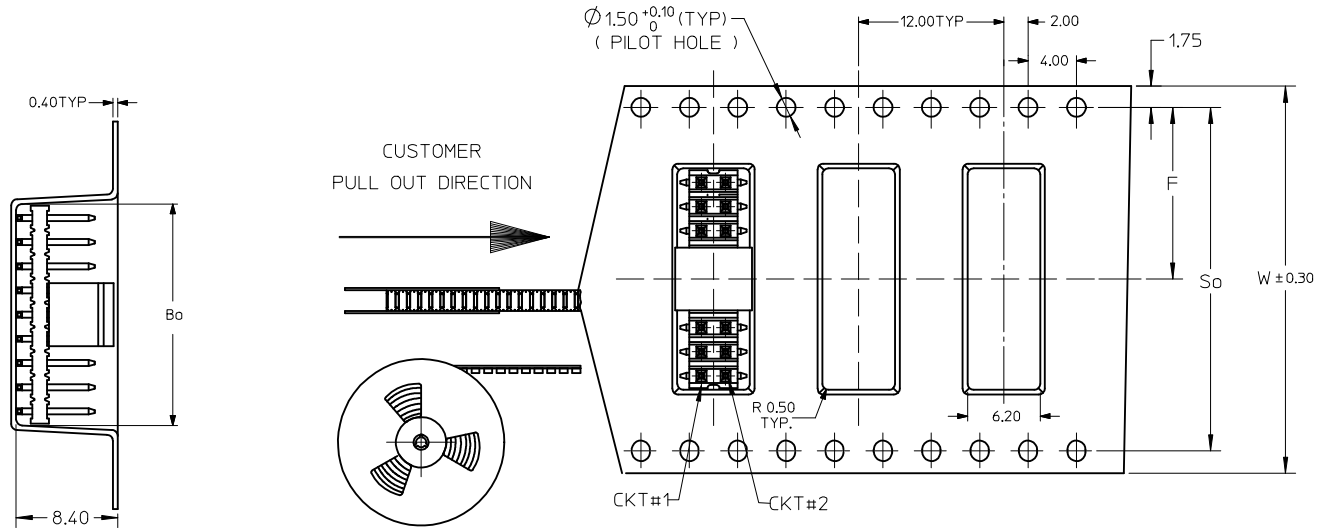

ADD. OPTION EC NO: S2009-0510 DRWN:ATSEE 2009/01/23 CHKD:SKANG 2009/02/09 APPR:MLONG 2009/02/17	QUALITY SYMBOLS ▽=0 ◻=0	GENERAL TOLERANCES (UNLESS SPECIFIED) mm INCH 4 PLACES ± --- ± --- 3 PLACES ± --- ± --- 2 PLACES ± 0.2 ± --- 1 PLACE ± --- ± --- ANGULAR ± 3 °	DIMENSION STYLE MM ONLY DRAWN BY: KSEE DATE: 2003/12/12 CHECKED BY: KCLING DATE: 2004/01/12 APPROVED BY: SKTOH DATE: 2004/01/12	SCALE: NTS DESIGN UNITS: METRIC THIRD ANGLE PROJECTION	TITLE: CUSTOM HEADER MGRID, 2MM DUAL ROW HDR. SMT MOLEX INCORPORATED DOCUMENT NO. SD-87759-117	SHEET NO. 4 OF 6
	DRAFT WHERE APPLICABLE MUST REMAIN WITHIN DIMENSIONS	SEE TABLE	THIS DRAWING CONTAINS INFORMATION THAT IS PROPRIETARY TO MOLEX INCORPORATED AND SHOULD NOT BE USED WITHOUT WRITTEN PERMISSION			
	B2	REV				

THIS TYPE OF CARRIER IS FOR CKT SIZE 8 AND BELOW.

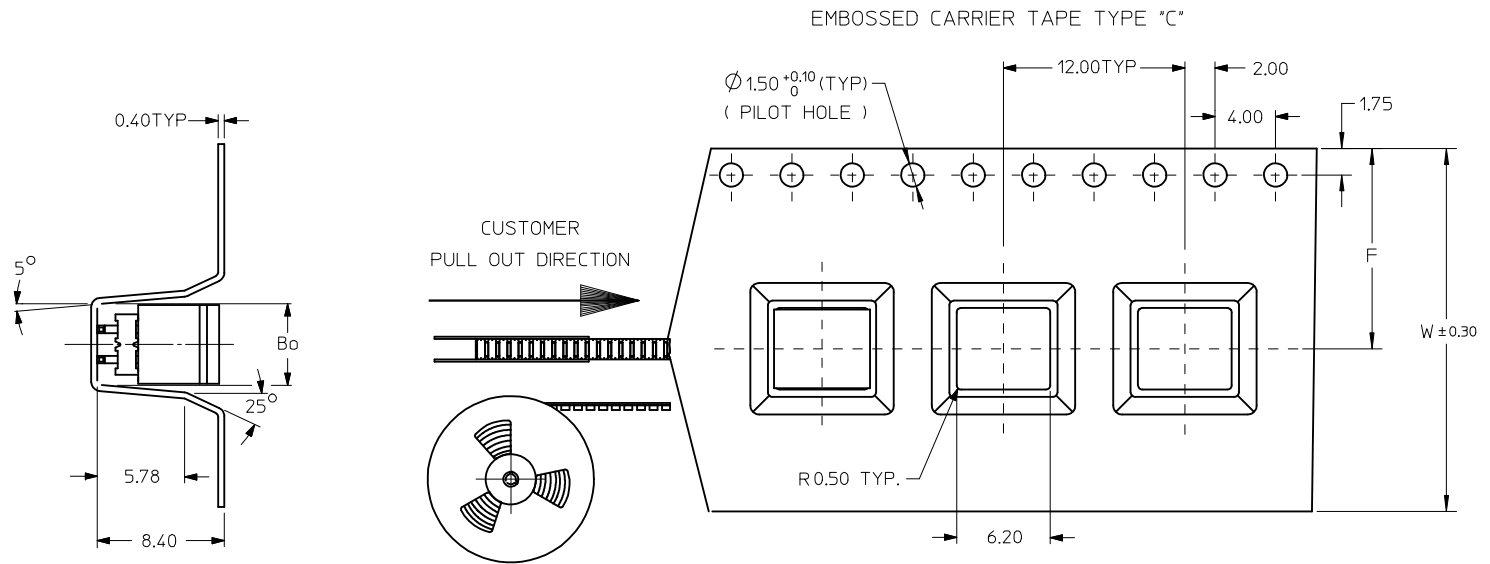

<b>ADD. OPTION</b> EC NO: S2009-0510 DRWN:ATSEE 2009/01/23 CHKD:SKANG 2009/02/09 APPR:MLONG 2009/02/17	DESCRIPTION REV	QUALITY SYMBOLS ▽=0 ◻=0	GENERAL TOLERANCES (UNLESS SPECIFIED)		DIMENSION STYLE <b>MM ONLY</b>		SCALE NTS	DESIGN UNITS METRIC	THIRD ANGLE PROJECTION		
			mm	INCH	DRAWN BY	DATE	TITLE				
		4 PLACES	± ---	± ---	KSEE	2003/12/12	<b>CUSTOM HEADER          MGRID, 2MM DUAL ROW HDR.          SMT</b>				
		3 PLACES	± ---	± ---	CHECKED BY	DATE					
	± 0.2	± ---	KCLING	2004/01/12	<b>MOLEX INCORPORATED</b>						
2 PLACES	± 0.2	± ---	APPROVED BY	DATE							
1 PLACE	± ---	± ---	SKTOH	2004/01/12	MATERIAL NO.      DOCUMENT NO.						
ANGULAR ± 3 °			DRAFT WHERE APPLICABLE MUST REMAIN WITHIN DIMENSIONS							SIZE	
					A3		THIS DRAWING CONTAINS INFORMATION THAT IS PROPRIETARY TO MOLEX INCORPORATED AND SHOULD NOT BE USED WITHOUT WRITTEN PERMISSION		5 OF 6		

	10	9	8	7	6	5	4	3	2	1		
	PART NUMBER WITHOUT CAP IN TUBE	PART NUMBER WITH CAP IN TUBE	PART NUMBER WITH CAP IN TAPE AND REEL.	CKT SIZE	VOID CKTS	A	B	Bo	F	So	W	EMBOSSED TYPE
F	87759-0414 $\triangle_9 \triangle_{10}$	87759-0464	87759-0474	4	--	NA	2.00	5.40	11.50	-	24.00	C
	87759-0614 $\triangle_9$	87759-0664	87759-0674	6	--	NA	4.00	7.20	11.50	-	24.00	C
	87759-0814	87759-0864	87759-0874	8	--	7.90	6.00	8.20	11.50	-	24.00	C
	87759-1014	87759-1064	87759-1074	10	--	9.90	8.00	10.20	11.50	-	24.00	A
	87759-1002 $\triangle_A$	87759-1003 $\triangle_A$	87759-1004 $\triangle_A$	10	10	9.90	8.00	10.20	11.50	-	24.00	A
	87759-1214	87759-1264	87759-1274	12	--	11.90	10.00	12.20	11.50	-	24.00	A
E	87759-1414	87759-1464	87759-1474	14	--	13.90	12.00	14.20	11.50	-	24.00	A
	87759-1614	87759-1664	87759-1674	16	--	15.90	14.00	16.20	14.20	28.40	32.00	B
	87759-1814	87759-1864	87759-1874	18	--	17.90	16.00	18.20	14.20	28.40	32.00	B
	87759-2014	87759-2064	87759-2074	20	--	19.90	18.00	20.20	14.20	28.40	32.00	B
	87759-2214	87759-2264	87759-2274	22	--	21.90	20.00	22.20	20.20	40.40	44.00	B
D	87759-2414	87759-2464	87759-2474	24	--	23.90	22.00	24.20	20.20	40.40	44.00	B
	87759-2614	87759-2664	87759-2674	26	--	25.90	24.00	26.20	20.20	40.40	44.00	B
	87759-2814	87759-2864	87759-2874	28	--	27.90	26.00	28.20	20.20	40.40	44.00	B
	87759-3014	87759-3064	87759-3074	30	--	29.90	28.00	30.20	20.20	40.40	44.00	B
	87759-3214	87759-3264	87759-3274	32	--	31.90	30.00	32.20	20.20	40.40	44.00	B
	87759-3414	87759-3464	87759-3474	34	--	33.90	32.00	34.20	26.20	52.40	56.00	B
	87759-3614	87759-3664	87759-3674	36	--	35.90	34.00	36.20	26.20	52.40	56.00	B
C	87759-3814	87759-3864	87759-3874	38	--	37.90	36.00	38.20	26.20	52.40	56.00	B
	87759-4014	87759-4064	87759-4074	40	--	39.90	38.00	40.20	26.20	52.40	56.00	B
	87759-4214	87759-4264	87759-4274	42	--	41.90	40.00	42.20	26.20	52.40	56.00	B
	87759-4414	87759-4464	87759-4474	44	--	43.90	42.00	44.20	26.20	52.40	56.00	B
	87759-4614	87759-4664	87759-4674	46	--	45.90	44.00	46.20	26.20	52.40	56.00	B
	87759-4814	87759-4864	87759-4874	48	--	47.90	46.00	48.20	26.20	52.40	56.00	B
B	87759-5014	87759-5064	87759-5074	50	--	49.90	48.00	50.20	34.20	68.40	72.00	B

NOTES:

$\triangle_A$  VOIDED PIN CKT#10 FOR PART#87759-1002

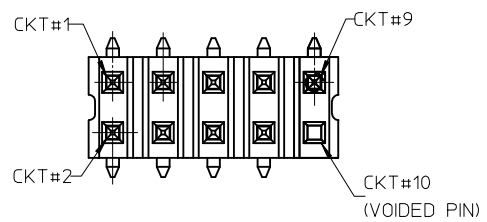

<b>ADD. OPTION</b> EC NO: S2009-0510 DRWN:ATSEE 2009/01/23 CHKD:SKANG 2009/02/09 APPR:MLONG 2009/02/17 B2	<b>QUALITY SYMBOLS</b> $\nabla=0$ $\triangle=0$	<b>GENERAL TOLERANCES (UNLESS SPECIFIED)</b> <table border="1"> <tr> <th></th> <th>mm</th> <th>INCH</th> </tr> <tr> <td>4 PLACES</td> <td><math>\pm</math> ---</td> <td><math>\pm</math> ---</td> </tr> <tr> <td>3 PLACES</td> <td><math>\pm</math> ---</td> <td><math>\pm</math> ---</td> </tr> <tr> <td>2 PLACES</td> <td><math>\pm</math> 0.2</td> <td><math>\pm</math> ---</td> </tr> <tr> <td>1 PLACE</td> <td><math>\pm</math> ---</td> <td><math>\pm</math> ---</td> </tr> </table>		mm	INCH	4 PLACES	$\pm$ ---	$\pm$ ---	3 PLACES	$\pm$ ---	$\pm$ ---	2 PLACES	$\pm$ 0.2	$\pm$ ---	1 PLACE	$\pm$ ---	$\pm$ ---	<b>DIMENSION STYLE</b> <b>MM ONLY</b> DRAWN BY: KSEE DATE: 2003/12/12 CHECKED BY: KCLING DATE: 2004/01/12 APPROVED BY: SKTOH DATE: 2004/01/12 MATERIAL NO. SKTOH	<b>SCALE</b> NTS <b>DESIGN UNITS</b> METRIC <b>THIRD ANGLE PROJECTION</b>	<b>TITLE</b> CUSTOM HEADER MGRID, 2MM DUAL ROW HDR. SMT <b>MOLEX INCORPORATED</b> DOCUMENT NO. SD-87759-117 SHEET NO. 6 OF 6
				mm	INCH															
			4 PLACES	$\pm$ ---	$\pm$ ---															
			3 PLACES	$\pm$ ---	$\pm$ ---															
2 PLACES	$\pm$ 0.2	$\pm$ ---																		
1 PLACE	$\pm$ ---	$\pm$ ---																		
<b>ANGULAR</b> $\pm$ 3°	<b>DRAFT WHERE APPLICABLE MUST REMAIN WITHIN DIMENSIONS</b>	<b>SIZE</b> A3	THIS DRAWING CONTAINS INFORMATION THAT IS PROPRIETARY TO MOLEX INCORPORATED AND SHOULD NOT BE USED WITHOUT WRITTEN PERMISSION																	