



### FEATURES

High AC Voltage - High current

### APPLICATIONS

Induction Heating, Tank Circuits

<b>KVAR</b>	<b>200</b>
<b>CAPACITANCE TOLERANCE</b>	<b>+/-10%</b>
<b>MAXIMUM CORE TEMPERATURE</b>	<b>+85°C</b>
<b>SURFACE TEMPERATURE</b>	<b>+45°C</b> (Above 45°C the KVAR rating must be de-rated by 2.25%/°C)
<b>CONSTRUCTION</b>	<b>Self-healing</b>
<b>SELF INDUCTANCE</b>	<b>&lt;3 nH</b>
<b>DIELECTRIC</b>	<b>Polypropylene</b>
<b>FLAME RETARDANT</b>	<b>UL94V0</b>

### Standard part listing

Capacitance (µF)	VAC	IC part number	Maximum RMS current (A)	MAX power kvar	Frequency range (kHz)	ESR (mΩ) 100kHz, +25°C	Dimensions (mm)			Terminal Style
							B	H	L	
0.05	1000	503HC2102K2CM6	250	200	636-994	1.5	30.2	30	68	2CM6
0.1	1000	104HC2102K2CM6	250	200	318-498	1.2	30.2	30	68	2CM6
0.17	900	174HC2900K2CM6	300	200	232-422	1	30.2	30	68	2CM6
0.25	800	254HC2800K2CM6	300	200	199-286	0.9	30.2	30	68	2CM6
0.33	800	334HC2800K2CM6	300	200	150-216	0.8	30.2	30	68	2CM6
0.5	800	504HC2800K2CM6	350	200	98-194	0.6	30.2	30	68	2CM6
0.66	700	664HC2700K2CM6	400	200	98-193	0.4	30.2	30	68	2CM6
1.2	600	125HC2600K2CM6	450	200	74-134	0.4	30.2	30	68	2CM6
1.33	600	135HC2600K2CM6	450	200	65-120	0.4	30.2	30	68	2CM6
2.4	450	245HC2450K2CM6	500	200	65-85	0.3	30.2	30	68	2CM6



### LEAD STYLE: 2CM6

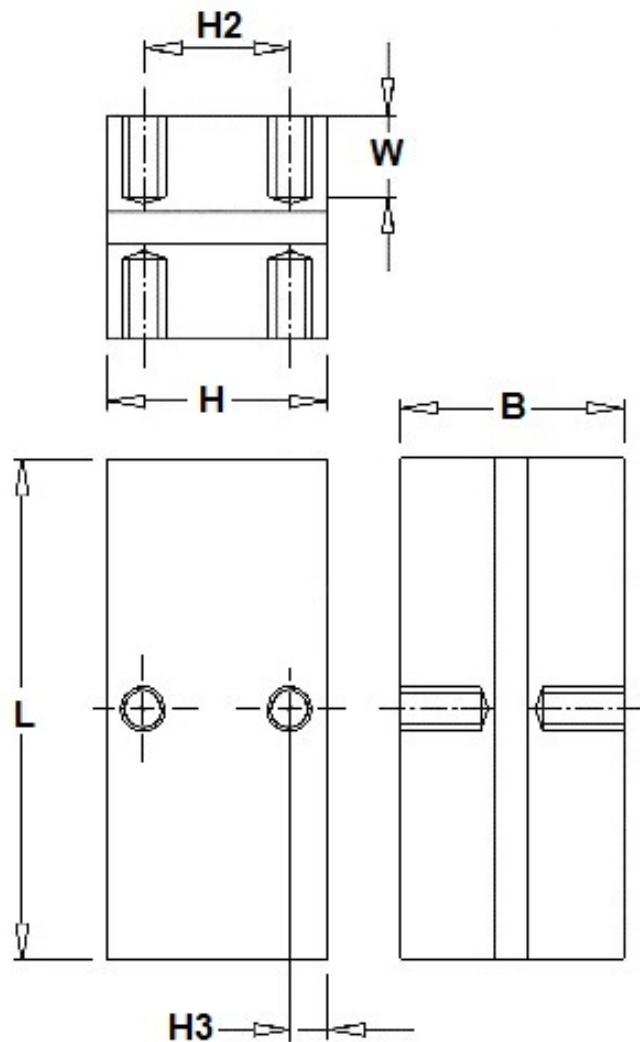

L	H	B	H2	H3	W
68 $\pm$ 0.5	30 $\pm$ 0.5	30.2 $\pm$ 0.1	20	5	10
Mounting Holes: M6x1 Tap fitted with SS helicoil					
Tightening torque: 15Nm MAX					

# HC2

## High Power Resonant Capacitors



### Frequency Derating

—●— Voltage    —■— Current    —▲— Power

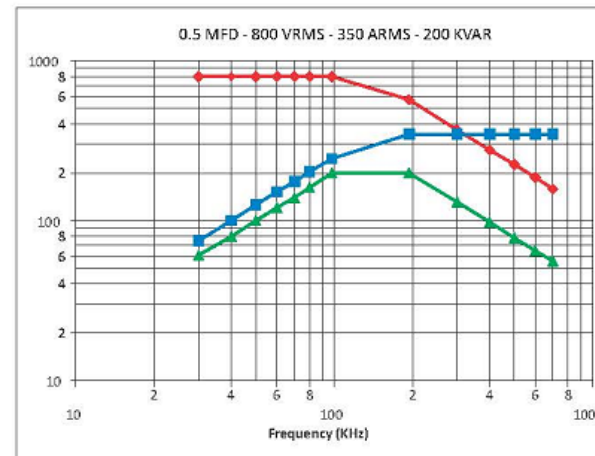
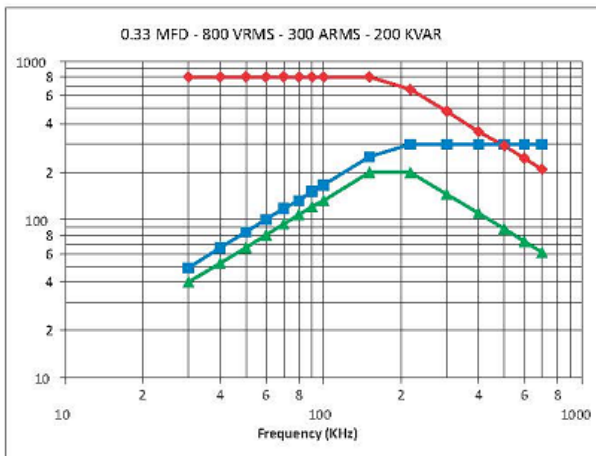
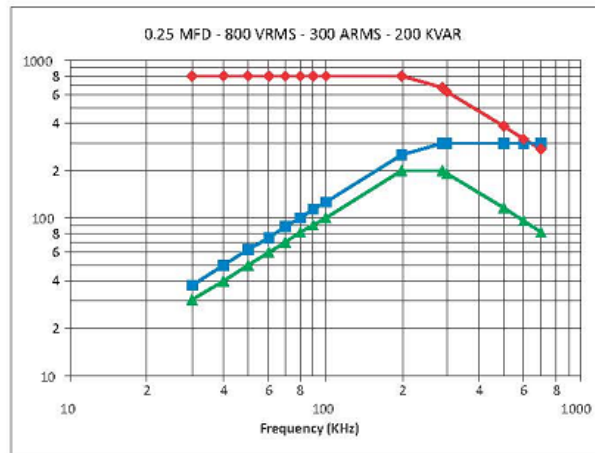
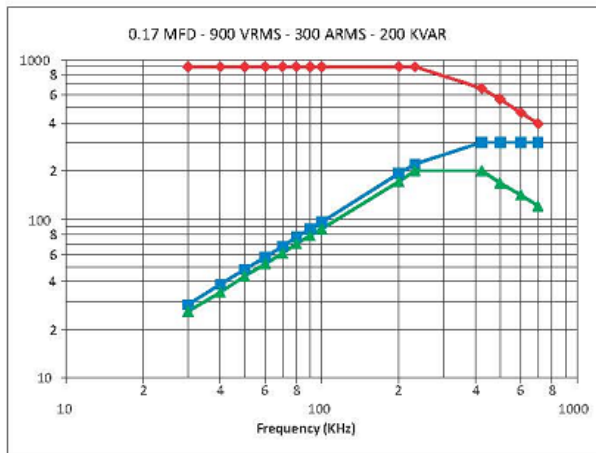
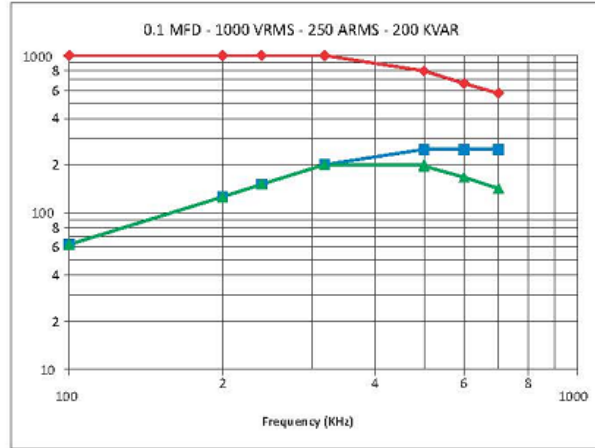
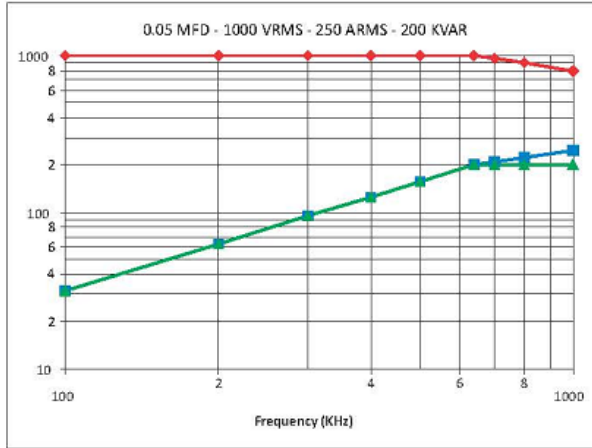

Your Global Source for World-Class Capacitors

© 2013 Illinois Capacitor, Inc.

**North America**  
Tel: 847.675.1760  
sales@illcap.com

**Asia**  
Tel: 852.2793 0931  
sales@illcap.com.hk

# HC2

## High Power Resonant Capacitors



### Frequency Derating

— Voltage — Current — Power

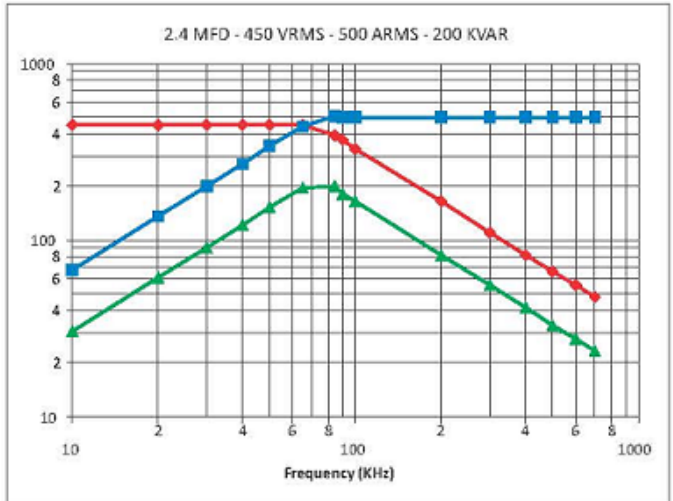
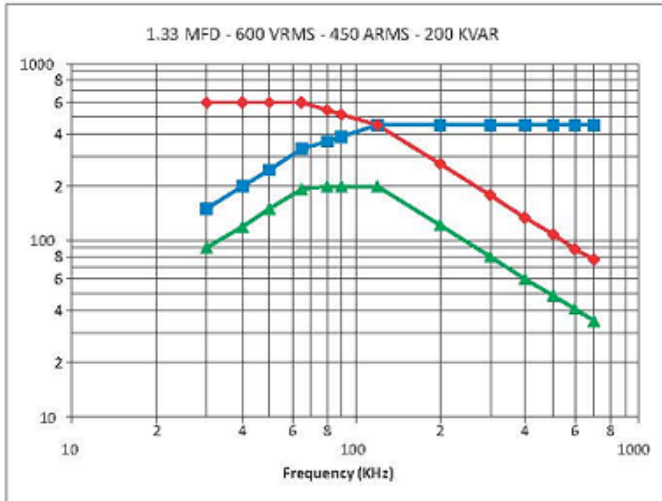
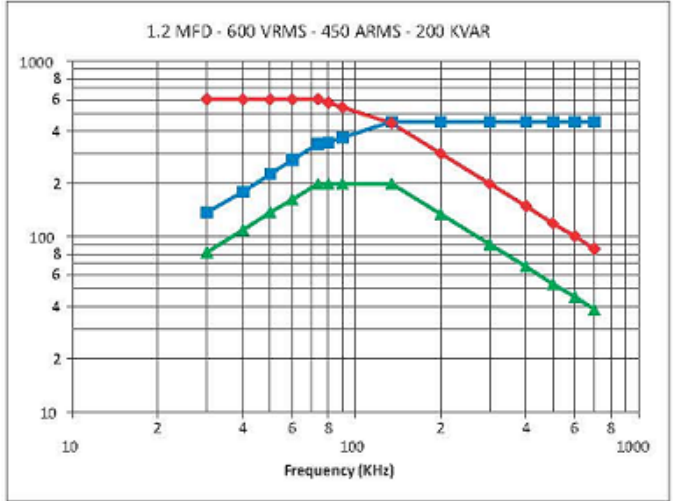
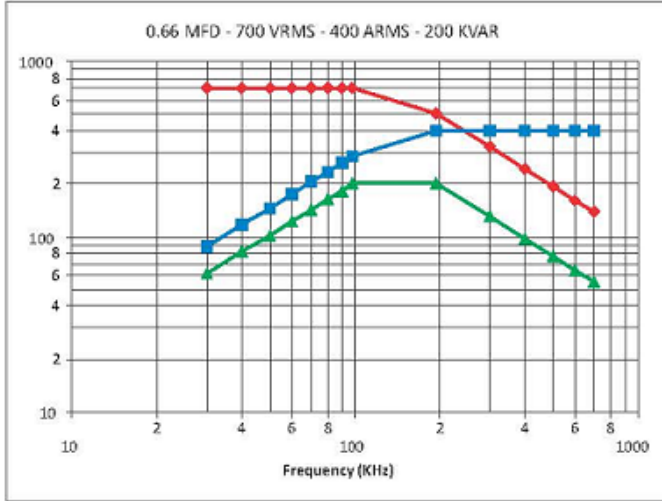

Your Global Source for World-Class Capacitors

© 2013 Illinois Capacitor, Inc.

**North America**  
Tel: 847.675.1760  
sales@illcap.com

**Asia**  
Tel: 852.2793 0931  
sales@illcap.com.hk