

PLEASE CHECK WWW.MOLEX.COM FOR LATEST PART INFORMATION

Part Number: [0003092158](#)
Status: **Active**
Overview: [standard_093](#)
Description: 2.36mm (.093") Diameter Standard .093 Pin and Socket Plug Housing, 15 Circuits, 3 Rows

Documents:

3D Model	Product Specification PS-1375-001 (PDF)
Packaging Specification (PDF)	Product Specification PS-1375-002 (PDF)
Drawing (PDF)	RoHS Certificate of Compliance (PDF)
Product Specification PS-02-09 (PDF)	

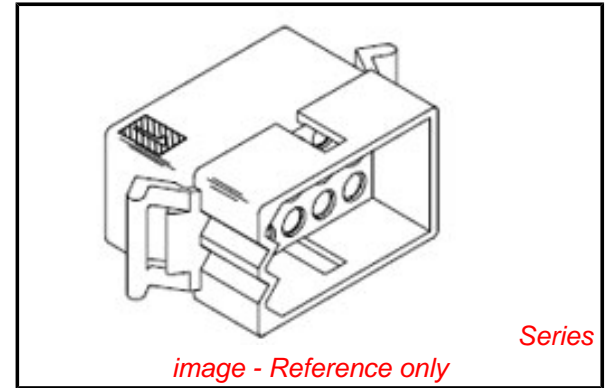

Agency Certification

CSA	LR19980
UL	E29179

General

Product Family	Crimp Housings
Series	1375
Comments	12.5A max. can be achieved when housing is used with 42477 or 42478 terminals
Overview	standard_093
Product Name	Standard .093"

Physical

Circuits (maximum)	15
Color - Resin	Natural
Flammability	94V-2
Gender	Dual
Glow-Wire Compliant	No
Material - Resin	Nylon
Number of Rows	3
Packaging Type	Bag
Panel Mount	No
Pitch - Mating Interface (in)	0.198 In
Pitch - Mating Interface (mm)	5.03 mm
Stackable	No
Temperature Range - Operating	-40°C to +105°C

Electrical

Current - Maximum per Contact	9.5A
-------------------------------	------

Material Info

Old Part Number	1375P7
-----------------	--------

Reference - Drawing Numbers

Packaging Specification	PK-1375-001
Product Specification	PS-02-09, PS-1375-001, PS-1375-002
Sales Drawing	SD-1375-*

EU RoHS

ELV and RoHS Compliant
REACH SVHC Contains SVHC: No
Halogen-Free Status
Not Reviewed

China RoHS



Need more information on product environmental compliance?

Email productcompliance@molex.com
 For a multiple part number RoHS Certificate of Compliance, [click here](#)

Please visit the [Contact Us](#) section for any non-product compliance questions.

Search Parts in this Series

[1375Series](#)

Mates With

[1375r](#)

Use With

[1189](#) Crimp Terminals, [1190](#) Crimp Terminals, [1376](#) Male PC Tail Terminals, [1377](#) Female PC Tail Terminals, [1380](#) Male Crimp Terminals, [1381](#) Female Crimp Terminals, [1433](#) Crimp Terminals, [1434](#) Male Crimp Terminals, [1973](#) , [2151](#) , [2273](#) , [2870](#) , [2871](#) , [4272](#) , [4550](#) , [6271](#) , [6310](#) , [42477](#) , [42478](#)

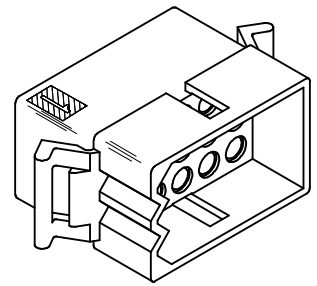
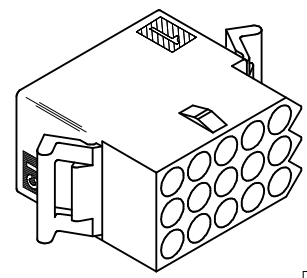
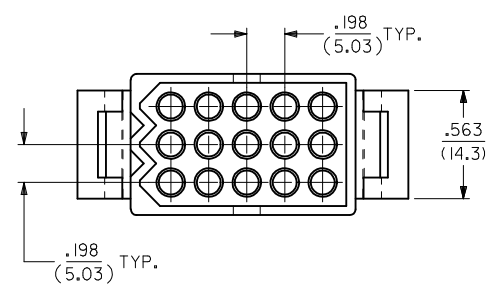
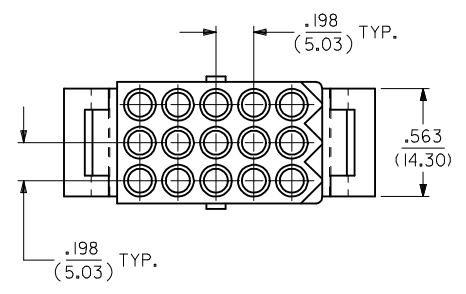
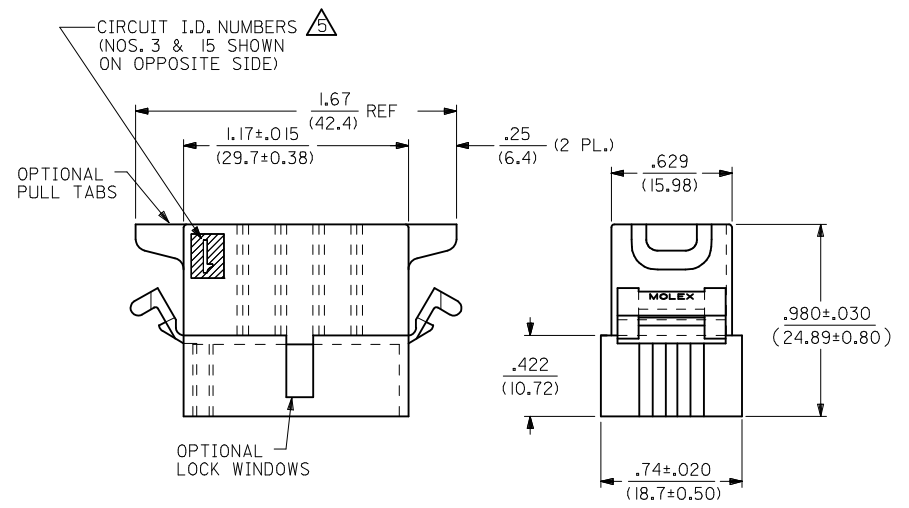
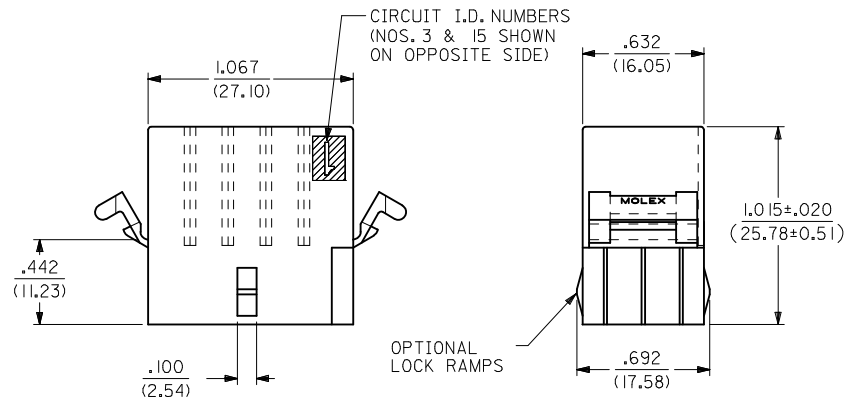
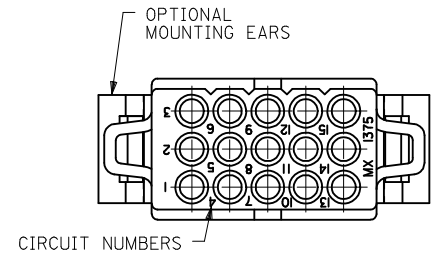
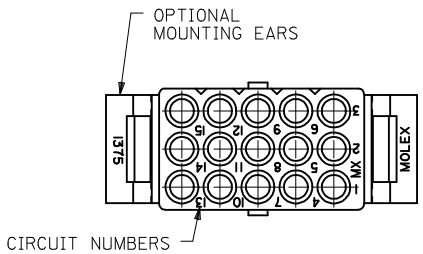

RECEPTACLE

PLUG

UPDATE TITLE BLOCK EC NO: UCP2007-2415 DRAWN: ELHAG CHKD: LSCHMIDT APPR: FSM LTH	2007/04/17 2007/05/03 2007/05/03	QUALITY SYMBOLS ▽=0 ▽=0	GENERAL TOLERANCES (UNLESS SPECIFIED) mm INCH	DIMENSION STYLE IN/MM	SCALE 2:1	DESIGN UNITS INCH	THIRD ANGLE PROJECTION
		4 PLACES ± --- ± --- 3 PLACES ± --- ± .010 2 PLACES ± 0.25 ± .014 1 PLACE ± 0.35 ± --- ANGULAR ± 1/2°	DRAWN BY DATE KBW 01/14/1989 CHECKED BY DATE RW 01/14/1989 APPROVED BY DATE RAS 01/14/1989	TITLE .093/(2.36) HOUSINGS PLUG & RECEPTACLE 15 CIRCUIT .198/(5.03)CL	MATERIAL NO. SEE CHART	DOCUMENT NO. SD-1375-*	SHEET NO. 1 OF 2
AE	REV	DESCRIPTION	DRAFT WHERE APPLICABLE MUST REMAIN WITHIN DIMENSIONS	THIS DRAWING CONTAINS INFORMATION THAT IS PROPRIETARY TO MOLEX INCORPORATED AND SHOULD NOT BE USED WITHOUT WRITTEN PERMISSION			

