

# Pressure Sensors

140PC Series

## Absolute, Differential, Gage, Vacuum Gage/Amplified

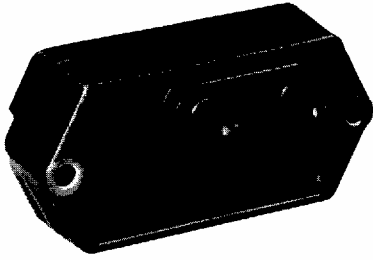

### FEATURES

- PCB terminals on opposite side from the ports
- Fully signal conditioned

### 140PC SERIES PERFORMANCE CHARACTERISTICS at 8.0 ±0.01 VDC Excitation, 25°C

	Min.	Typ.	Max.	Units
Excitation*	7.00	8.00	16.0	VDC
Supply Current	---	8.00	20.0	mA
Current Sourcing Output	---	---	10	mA
Null Offset (141/142PC)	0.95	1.00	1.05	V
Null Offset (143PC)**	3.45	3.50	3.55	V
Null Offset				
142PC15A @ 2 psia	1.62	1.67	1.72	V
142PC30A @ 2 psia	1.28	1.33	1.38	V
Output at Full Pressure	5.90	6.00	6.10	V
Span† (141/142PC)	4.95	5.00	5.05	V
Span† (143PC)**	---	5.00	---	V
Span				
142PC15A	4.28	4.33	4.48	V
142PC30A	4.62	4.67	4.72	V
Ratiometricity Error				
7 to 8 V or 8 to 9 V	---	±0.50	---	%Span
9 to 12 V	---	±2.00	---	
Stability over One Year	---	±0.50	---	%Span
Response Time	---	---	1.00	msec
Common Mode Pressure***	---	---	40	psi
Weight	---	5	---	grams
Short Circuit Protection	Output may be shorted indefinitely to ground			
Output Ripple	None, DC device			
Ground Reference	Supply and output are common			

\*8.0 VDC excitation is recommended with 1 psi unit.

\*\*Positive and negative pressure measurement.

\*\*\*Higher common mode pressures possible if sensor is not used over entire operating temperature range.

†Span is defined as the algebraic difference between end points. Please note: actual output is 1 V to 6 V (at 8.00 ±0.01 VDC). Span is then 5V.

### ENVIRONMENTAL SPECIFICATIONS

Operating Temperature	-40° to +85°C (-40° to +185°F)
Storage Temperature	-55° to +125°C (-67° to +257°F)
Compensated Temperature	-18° to +63°C (0° to +145°F)
Shock	MIL-STD-202, Method 213 (50 g, half sine, 11 msec)
Vibration	MIL-STD-202, Method 204 (10 to 2000 Hz at 10 g)
Media	P2 port Wetted materials; polyester housing, epoxy adhesive, silicon, borosilicate glass, and silicon-to-glass bond*
	P1 port Dry gases only

\*Liquid media containing some highly ionic solutions could potentially neutralize the chip-to-glass tube bond.

# Pressure Sensors

140PC Series

## Absolute, Differential, Gage, Vacuum Gage/Amplified

### 140PC SERIES ORDER GUIDE, VACUUM GAGE TYPE

Catalog Listing	Pressure Range psi	Combined Null & Sensitivity Shift (% Span)				Sensitivity V/psi	Overpressure psi Max.	Linearity, B.F.S.L.		Repeatability & Hysteresis %Span Typ.		
		25 to 5° 25 to 45°C		25 to -18° 25 to +63°C	25 to -40° 25 to 85°C			P2 > P1	P2 < P1			
		%Span						Max.	Max.			
		Typ.	Max.	Max.	Max.			Max.	Max.			
141PC01G	0-1	---	±1.50	---	---	5.000	20	---	±0.75	±0.30		
141PC05G	0-5	±0.50	---	±1.00	±2.00	1.000	20	---	±0.75	±0.25		
141PC15G	0-15	±0.50	---	±1.00	±2.00	0.333	45	---	±0.40	±0.15		

### 140PC SERIES ORDER GUIDE, GAGE TYPE

Catalog Listing	Pressure Range psi	Combined Null & Sensitivity Shift (% Span)				Sensitivity V/psi	Overpressure psi Max.	Linearity, B.F.S.L.		Repeatability & Hysteresis %Span Typ.		
		25 to 5° 25 to 45°C		25 to -18° 25 to +63°C	25 to -40° 25 to 85°C			P2 > P1	P2 < P1			
		%Span						Max.	Max.			
		Typ.	Max.	Max.	Max.			Max.	Max.			
142PC01G	0-1	---	±1.50	---	---	5.000	20	±0.75	---	±0.30		
142PC02G	0-2	---	±1.50	---	---	2.500	20	±0.75	---	±0.30		
142PC05G	0-5	±0.50	---	±1.00	±2.00	1.000	20	±1.50	---	±0.25		
142PC15G	0-15	±0.50	---	±1.00	±2.00	0.333	45	±0.75	---	±0.15		
142PC30G	0-30	±0.50	---	±1.00	±2.00	0.167	60	±0.75	---	±0.15		
143PC03G	±2.5	---	---	±1.00	±1.50	1.000	20	±0.75	---	±0.25		
143PC05G	±5	---	---	±1.00	±1.50	0.500	30	±0.75	---	±0.15		
143PC15G	±15	---	---	±1.00	±1.50	0.177	50	±0.75	---	±0.15		

### 140PC SERIES ORDER GUIDE, DIFFERENTIAL TYPE

Catalog Listing	Pressure Range psi	Combined Null & Sensitivity Shift (% Span)				Sensitivity V/psi	Overpressure psi Max.	Linearity, B.F.S.L.		Repeatability & Hysteresis %Span Typ.		
		25 to 5° 25 to 45°C		25 to -18° 25 to +63°C	25 to -40° 25 to 85°C			P2 > P1	P2 < P1			
		%Span						Max.	Max.			
		Typ.	Max.	Max.	Max.			Max.	Max.			
142PC01D	0-1	---	±1.50	---	---	5.000	20	±0.75	±0.40	±0.30		
142PC02D	0-2	---	±1.50	---	---	2.500	20	±0.75	±0.40	±0.30		
142PC05D	0-5	±0.50	---	±1.00	±2.00	1.000	20	±1.50	±0.75	±0.25		
142PC15D	0-15	±0.50	---	±1.00	±2.00	0.333	45	±0.75	±0.40	±0.15		
142PC30D	0-30	±0.50	---	±1.00	±2.00	0.167	60	±0.75	±0.40	±0.15		
143PC03D	±2.5	---	---	±1.00	±1.50	1.000	20	±0.75	±0.40	±0.25		
143PC05D	±5	---	---	±1.00	±1.50	0.500	30	±0.75	±0.40	±0.15		
143PC15D	±15	---	---	±1.00	±1.50	0.177	50	±0.75	±0.40	±0.15		

Amplified

### 140PC SERIES ORDER GUIDE, ABSOLUTE TYPE\*

Catalog Listing	Pressure Range psia	Combined Null & Sensitivity Shift (% Span)				Sensitivity V/psi	Overpressure psi Max.	Linearity, B.F.S.L.		Repeatability & Hysteresis %Span Typ.		
		25 to 5° 25 to 45°C		25 to -18° 25 to +63°C	25 to -40° 25 to 85°C			P2 > P1	P2 < P1			
		%Span						Max.	Max.			
		Typ.	Max.	Max.	Max.			Max.	Max.			
142PC15A	0-15	±0.50	---	±1.00	±2.00	0.333	45	---	±0.40	±0.15		
142PC30A	0-30	±0.50	---	±1.00	±2.00	0.167	60	---	±0.40	±0.15		

\* Tested at 2 psia reference

# Pressure Sensors

140PC Series

## Absolute, Differential, Gage, Vacuum Gage/Amplified

### ELECTRICAL CONNECTION

#### Voltage Excitation

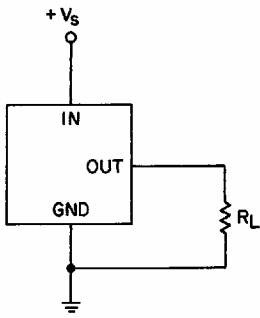

### NOTES

1. Terminals are labeled on the sensor.
2. Input and output share a common ground.
3.  $R_L$  must be greater than or equal to 3000 ohms.

### INTERNAL CIRCUITRY

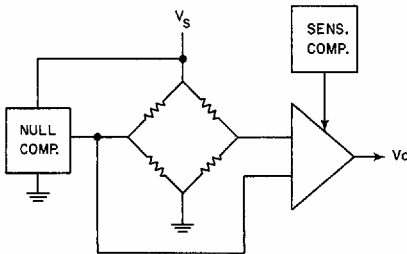

### RATIOMETRICITY

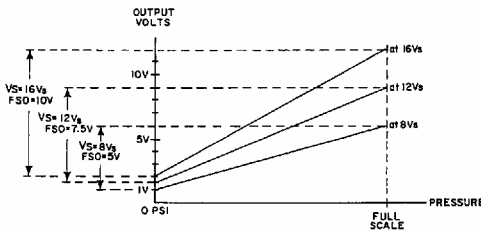

Ratiometricity refers to the output voltage being directly proportional to the supply voltage. 140PC sensors in this catalog are calibrated at 8 VDC supply voltage to provide a 1-6 volt (5V Span) output swing. For example, if supply increases by 50% to 12 VDC, the output voltage increases by 50% to 1.5-9 volts (7.5 V Span).

### NOTE

The output is not perfectly ratiometric. See specifications for the degree of error.

### NULL AND SENSITIVITY TEMPERATURE SHIFT

Amplified pressure sensors are 100% tested to insure that the maximum null and sensitivity temperature shift does not exceed the specification. The diagram below illustrates how null and sensitivity shift relates to temperature. Note that the maximum shift occurs at temperature extremes. Therefore, if a sensor is not ex-

posed to the entire temperature range, the maximum null and sensitivity shift will actually be less than the value specified.

This diagram indicates the temperature shift pertaining to a few listings. Maximum null and sensitivity shift varies from listing to listing.

NULL AND SENSITIVITY SHIFT (% F.S.O.)

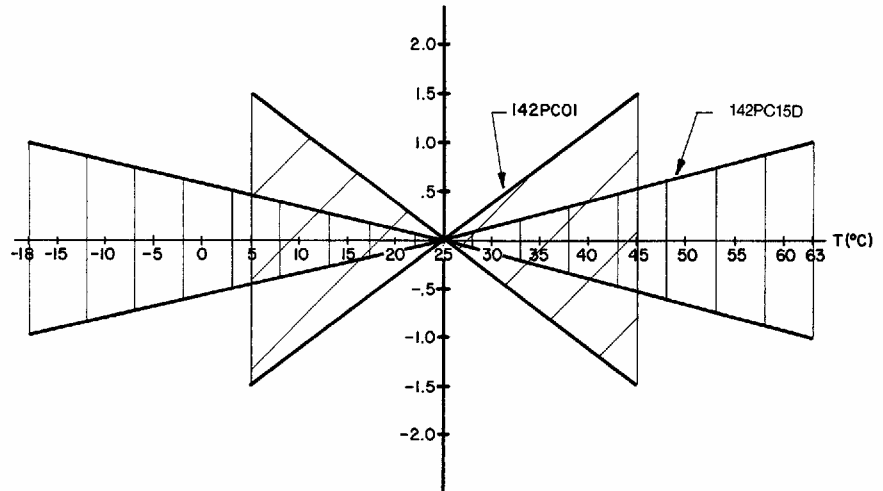

### SCALING OF 140PC SERIES SENSORS WITH 8V EXCITATION

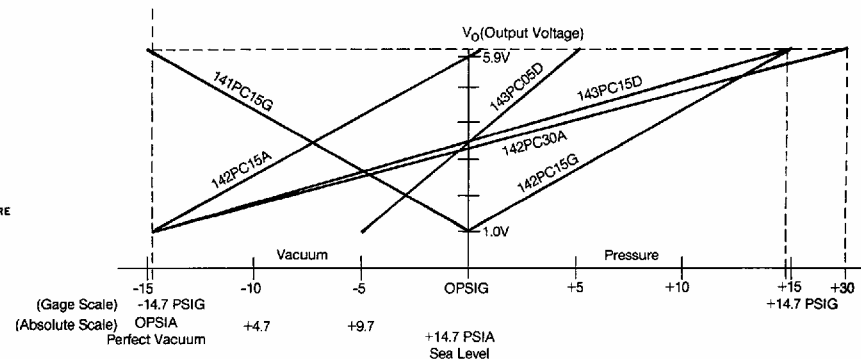

142PC15A	Absolute	$V_O = 1 \text{ V at } 0 \text{ psia} \ \& \ 6 \text{ V at } 15 \text{ psia}$
142PC30A	Absolute	$V_O = 1 \text{ V at } 0 \text{ psia} \ \& \ 6 \text{ V at } 30 \text{ psia}$
142PC15G	Gage	$V_O = 1 \text{ V at } 0 \text{ psig} \ \& \ 6 \text{ V at } 15 \text{ psig}$
141PC15G	Vacuum Gage	$V_O = 1 \text{ V at } 0 \text{ psig} \ \& \ 6 \text{ V at } -15 \text{ psig}$
143PC05D	Differential	$V_O = 1 \text{ V at } -5 \text{ psig} \ \& \ 6 \text{ V at } 5 \text{ psig}$
143PC15D	Differential	$V_O = 1 \text{ V at } -15 \text{ psig} \ \& \ 6 \text{ V at } 15 \text{ psig}$

NOTE: 141PC sensors are scaled for vacuum pressure on P2.

142PC sensors are scaled for greater pressure on the P2 side of the chip. Input pressures on absolute units are applied to the P1 port.

Other scalings available upon request.

# Pressure Sensors

140PC Series

## Absolute, Differential, Gage, Vacuum Gage/Amplified

### MOUNTING DIMENSIONS (For reference only)

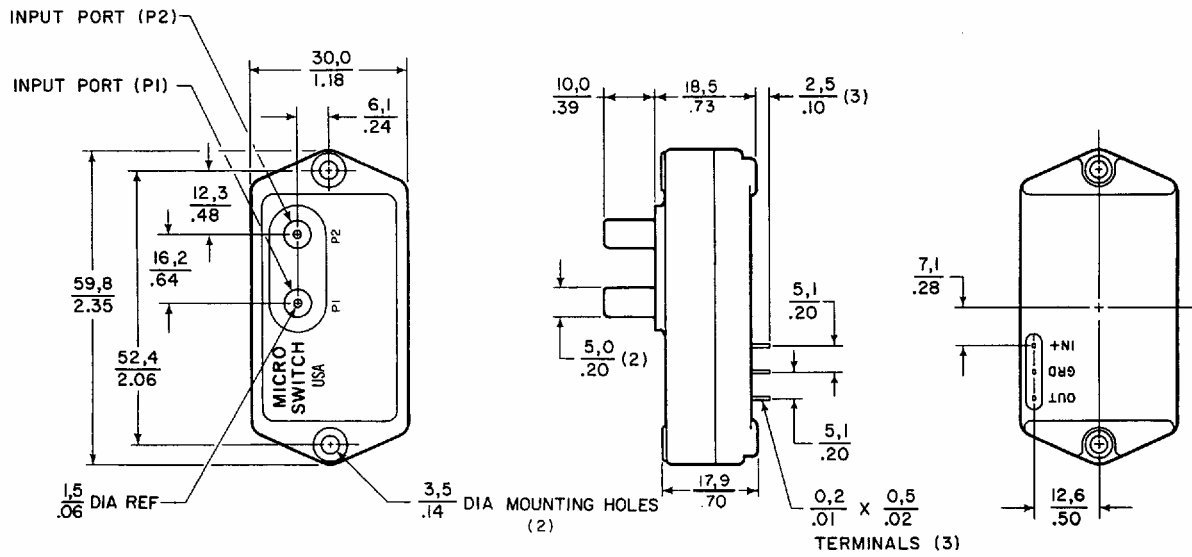

Dimensions shown apply to Differential and Absolute versions. Gage units are identical, except the P1 port is absent.

### 140PC CONSTRUCTION

