

Mutter / nut

Bolzen / bolt

Gewinde / thread  
M3 / #4-40

ohne / without

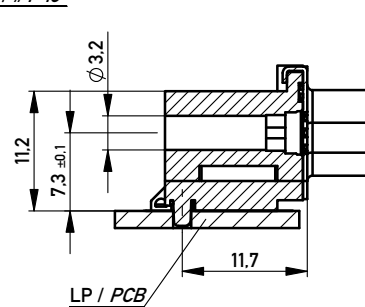
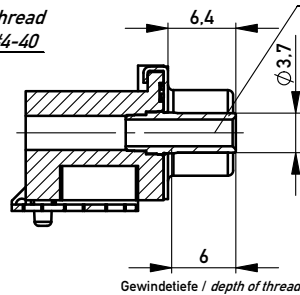
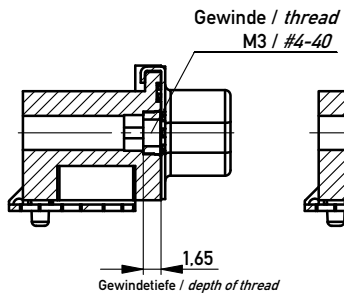

Anschlussbereich verzinkt  
terminal area tin plating

Koplanarität der Anschlüsse ≤ 0.1 mm  
coplanarity area of termination ≤ 0.1 mm

Anforderungsstufe: 2  
class: 2

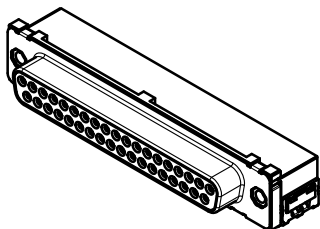

	174443	Ø3.2			
	154250			#4-40	
	154249			M3	
	154248		#4-40		
	154247		M3		
Ident-Nr. part-no. Gurt tape on reel	Ident-Nr. part-no. Tray tray	ohne without	Mutter nut	Bolzen bolt	Bemerkung remark

Verpackt in Tray  
Verpackungseinheit 16 Stück  
tray packaging  
packaging unit 16 pcs

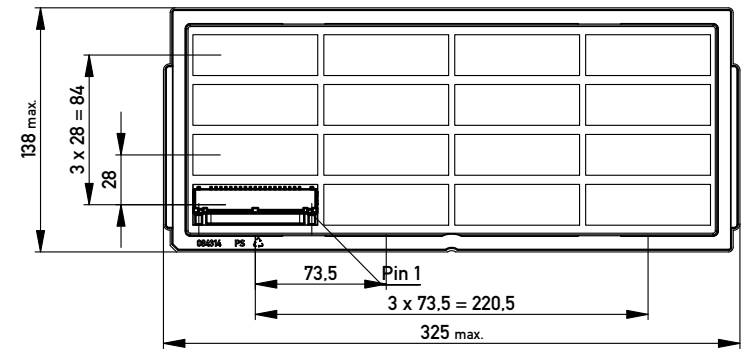

Sonstige Angaben siehe Zeichnung 204629 / additional indications according to drawing 204629

Verpackt in Gurtverpackung - Tape on Reel Packaging  
Verpackungseinheit: 75 Stück - Packaging unit: 75 pcs

Abspulrichtung - Reel off Direction

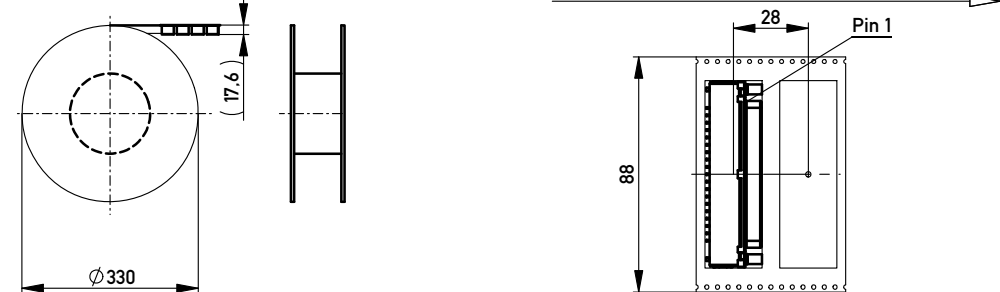

Sonstige Angaben siehe Zeichnung 204655 / additional indication according to drawing 204655

Layoutvorschlag  
recommended  
layout

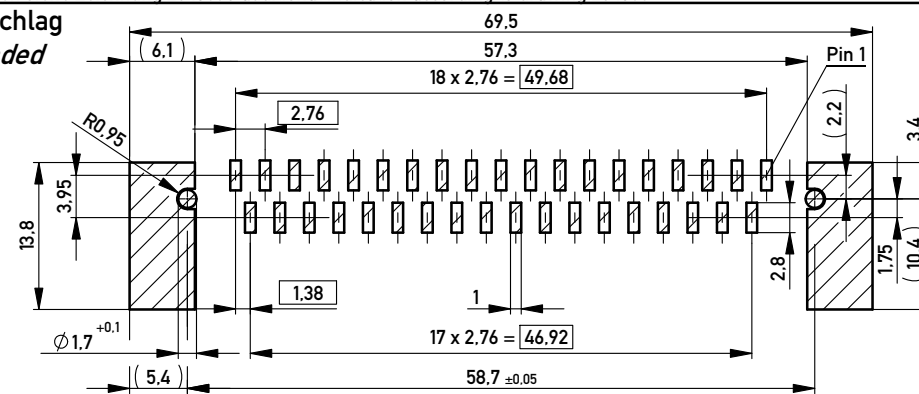

Fehlende Masse und Angaben siehe DIN 41652 / Missing information and dimensions according to DIN 41652  
Sonstige Angaben siehe Fertigungsunterlagen / Additional indications according to production documentation

Information:  All rights reserved. Only for Information. To ensure that this is the latest version of this drawing, please contact one of the ERNI companies before using.	Tolerances	 All Dimensions in mm	Scale 2:1
	Subject to modification without prior notice. Drawing will not be updated.		Designation <b>TMC-S-37-SMD-Standard-BA8</b> <i>TMC-S-37-SMD-Standard-BA8</i>
www.ERNI.com	<b>144842</b>		I A3
i Index	08.12.2011 Date	Class	TMCS