

PART No. 1486D12

for more information visit
www.hammfg.com

Data subject to change without notice

Isometric drawing Not to Scale

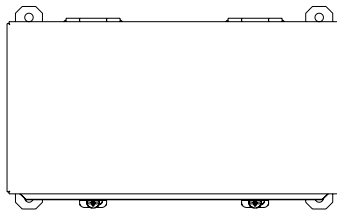

TOP VIEW

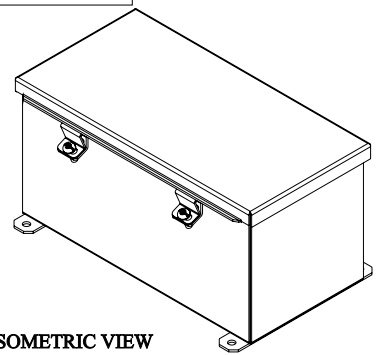

ISOMETRIC VIEW

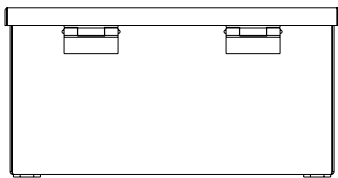

BACK VIEW

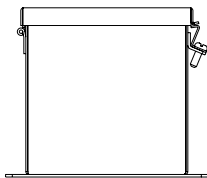

SIDE VIEW

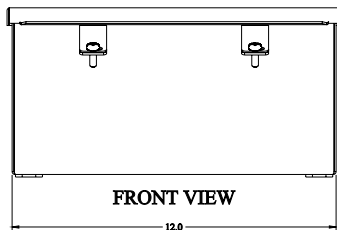

FRONT VIEW

12.0

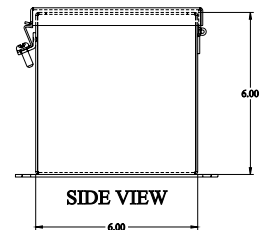

SIDE VIEW

6.00

6.00

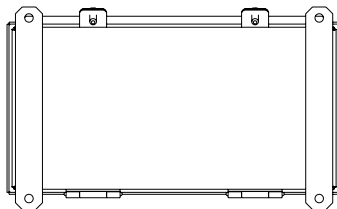

BOTTOM VIEW