

PART No. 1487D9P

for more information visit
www.hammfg.com

Data subject to change without notice

Isometric drawing Not to Scale

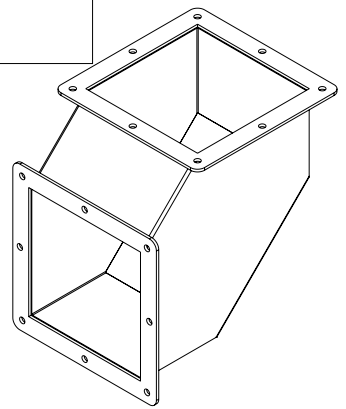

ISOMETRIC VIEW

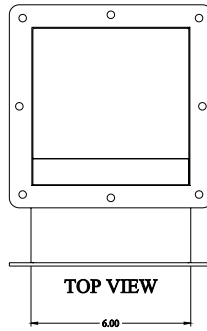

TOP VIEW

6.00

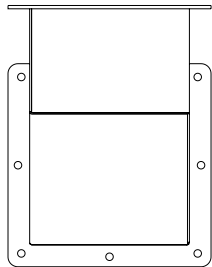

BACK VIEW

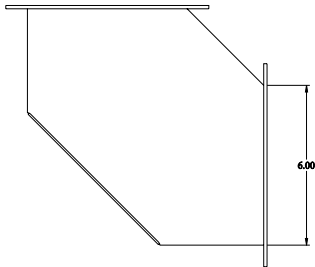

SIDE VIEW

6.00

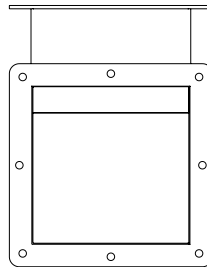

FRONT VIEW

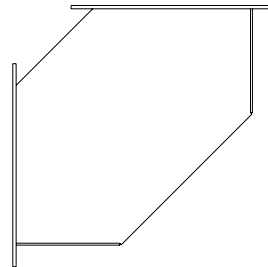

SIDE VIEW

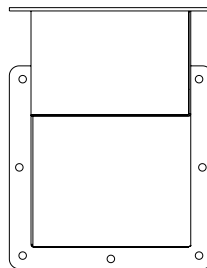

BOTTOM VIEW