

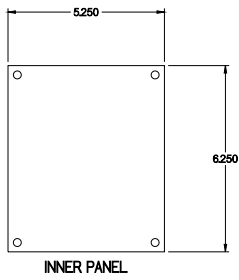

PART No. 1489P4
 for more information visit
www.hammfg.com
 Data subject to change without notice
 Isometric drawing Not to Scale

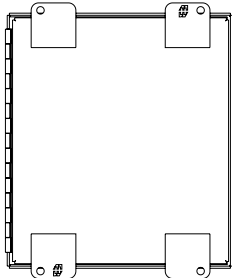

INNER PANEL



BACK VIEW

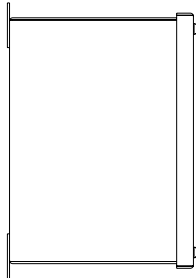

LEFT SIDE VIEW

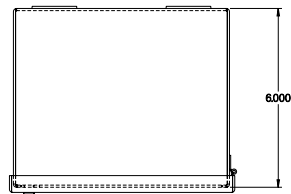

TOP VIEW

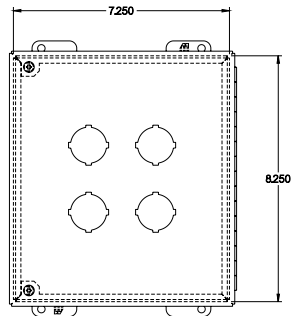

FRONT VIEW

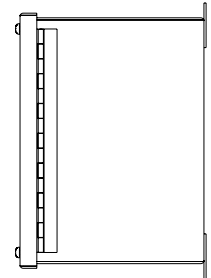

RIGHT SIDE VIEW

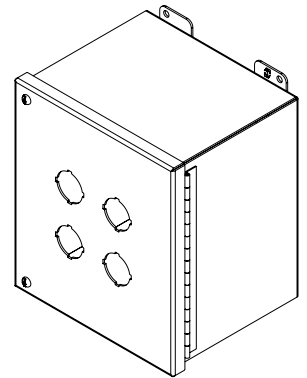

ISOMETRIC VIEW

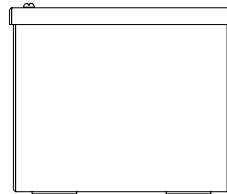

BOTTOM VIEW