

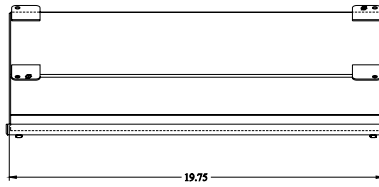

**PART No. 1490G16**  
 for more information visit  
[www.hammfg.com](http://www.hammfg.com)  
 Data subject to change without notice  
 Isometric drawing Not to Scale

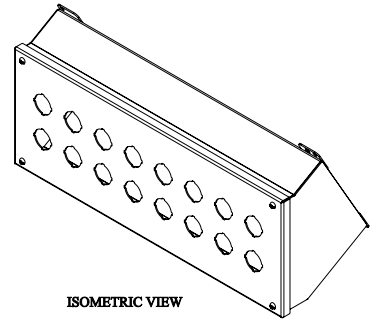

TOP VIEW

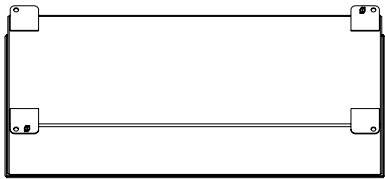

ISOMETRIC VIEW



BACK VIEW

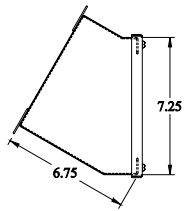

LEFT SIDE VIEW

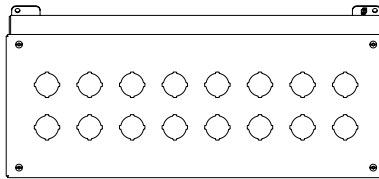

FRONT VIEW

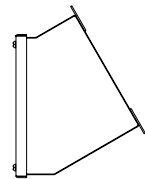

RIGHT SIDE VIEW

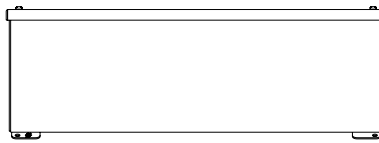

BOTTOM VIEW