

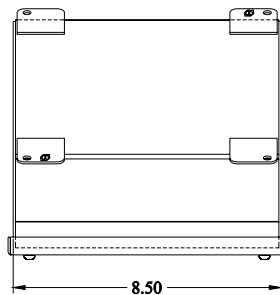

PART No. 1490H9
for more information visit
www.hammfg.com
Data subject to change without notice
Isometric drawing Not to Scale

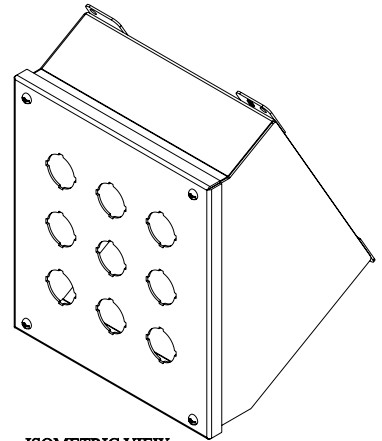

TOP VIEW



ISOMETRIC VIEW

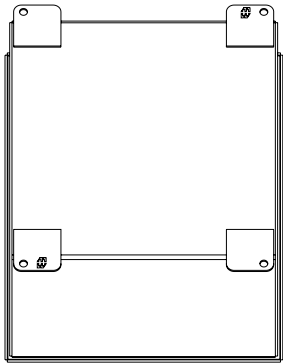

BACK VIEW

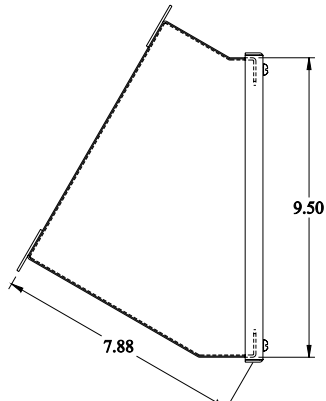

LEFT SIDE VIEW

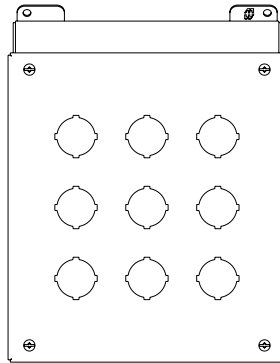

FRONT VIEW

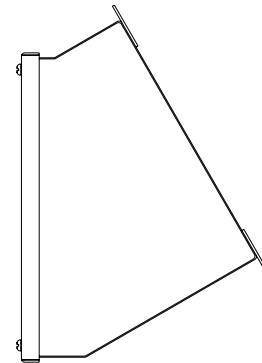

RIGHT SIDE VIEW

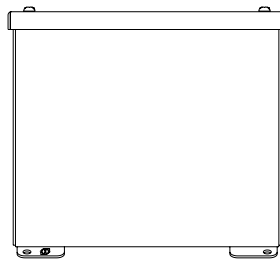

BOTTOM VIEW