



**WORLD PRODUCTS INC.**

# METAL OXIDE VARISTORS



**WORLD PRODUCTS INC.** || 19654 Eighth Street East || P.O. Box 517 || Sonoma, CA 95476  
Phone: (707) 996.5201 || FAX: (707) 996.3380 || [www.worldproducts.com](http://www.worldproducts.com) || [sales@worldproducts.com](mailto:sales@worldproducts.com)  
©2013 World Products Inc.



**THIS PAGE WAS INTENTIONALLY LEFT BLANK.**

## Table of Contents

Features . . . . .	2
Definition of Terms (according to IEEE specifications C62.33) . . . . .	2
Power Dissipation Ratings . . . . .	2
General Characteristics . . . . .	3
Part Marking . . . . .	3
Approvals . . . . .	4
Part Number System . . . . .	6
Standard Dimensions and Lead Modification Options . . . . .	7
D Series — Electrical Characteristics (5, 7, 10, 14, 20, 25 mm) . . . . .	18
High Energy E Series — Electrical Characteristics (5, 7, 10, 14, 20, 25 mm) . . . . .	24
VZ25R Series - Electrical Characteristics . . . . .	28
VZ32 KW (Wire Lead) Series — Electrical Characteristics . . . . .	29
VZ32 Series — Electrical Characteristics & Dimensions . . . . .	30
VZ34 Single Series — Electrical Characteristics & Dimensions . . . . .	32
VZ34 Dual Series — Electrical Characteristics & Dimensions . . . . .	34
VZ40 Series — Electrical Characteristics & Dimensions . . . . .	36
VZ53 Series — Electrical Characteristics & Dimensions . . . . .	38
Peak Pulse and Derating Curves . . . . .	40
V-I Characteristics . . . . .	41
Soldering Profile . . . . .	45
5mm / 7mm Taping Specifications . . . . .	48
10mm Taping Specifications . . . . .	50
14mm Taping Specifications . . . . .	54
18mm / 20mm Taping Specifications . . . . .	58
Standard Bulk Packaging . . . . .	60
Applications . . . . .	61
Circuit Examples . . . . .	62

## Features

- Our Metal Oxide Varistors have UL, CSA and VDE approvals. VDE approvals are in conjunction with IEC61051-2. Plus specific types comply with Accelerated Aging Test Requirements per ANSI/IEEE C62.11. The factory is ISO and TS16949 certified. Taped Parts conform to EIA standards. All electrical specifications are to industry standards with definitions conforming to IEEE specifications. Solderability to MIL STD. Epoxy flammability rating of 94V0.
- RoHS Compliance - Metal Oxide Varistors utilizing suffix (-N) denoting RoHS compliant types for disk sizes 05, 07, 10,14, 18, 20, 25, 32, 34, 40, and 53 purchased from World Products, LLC comply with RoHS Directive 2002/95/EC of the European Parliament and of the Council of 27 January 2003 on the restriction of the use of certain hazardous substances in electrical and electronic equipment. Our metal oxide varistors contain a maximum concentration value of 0.1% by weight in homogeneous materials for lead, mercury, hexavalent chromium, polybrominated biphenyls (PBB) and polybrominated diphenyl ethers (PBDE) and of 0.01% weight in homogeneous materials for cadmium. See Part Number System for more details.
- Product consistency is maintained through extremely stringent quality and statistical control. On-line automatic test equipment provides 100% inspection.
- Extensive selection of equivalents to essentially all metal oxide varistor types. All specifications available for proper accurate design-in purposes.
- Extremely low leakage current levels achieved and exceptional surge handling capability through proprietary formulations.
- Epoxy conformity and control providing for consistent physical dimensions and improved solderability.
- Varistor product design flexibility and quick design cycles in order to assist our customers with their most stringent varistor applications.



## Definition of Terms (according to IEEE specifications C62.33)

**Average Power Dissipation:** Tested using two consecutive pulses at rated peak current using a 10/1000 $\mu$ s test waveform with a minimum pulse period of 60 seconds between pulses (IEC 61000-4-5).

**Rated RMS Voltage, Rated DC Voltage:** The maximum designated values of power system voltage that may be applied continuously between the terminals of a device.

**Varistor Voltage:** Test characteristic that is used to classify varistors by type. A test current of 1mA DC is typically used to determine varistor voltage classification type. Varistor voltage clamping characteristics can be defined at various test levels.

**Rated Peak Single Pulse Transient Current:** Maximum surge current, 8/20 $\mu$ s waveform which a varistor is rated to withstand for a single surge.

**Rated Single Pulse Transient Energy:** Maximum allowable energy for a single impulse (see specified waveforms).

**Maximum Clamping Voltage:** Measured peak voltage across the device terminals when a current impulse of specified amplitude and waveform is conducted through the varistor.

**Typical Capacitance:** Typical capacitance values are measured at a test frequency of 1KHZ.

## Power Dissipation Ratings

Disk Size	Pm-watts
5mm (< 50 VAC)	0.01
5mm ( $\geq$ 50 VAC)	0.20
7mm (< 50 VAC)	0.02
7mm ( $\geq$ 50 VAC)	0.25
10mm (< 50 VAC)	0.05
10mm ( $\geq$ 50 VAC)	0.40
14mm (< 50 VAC)	0.10
14mm ( $\geq$ 50 VAC)	0.60

Disk Size	Pm-watts
20mm (< 50 VAC)	0.20
20mm ( $\geq$ 50 VAC)	1.00
25mm	1.20
32mm	1.60
34mm (Single)	2.10
34mm (Dual)	2.73
40mm	2.10
53mm	2.50

## General Characteristics

Storage Temperature	- 55° C to + 125° C
Operating Surface Temperature	125° C
Operating Ambient Temperature	- 55° C to + 85° C (without derating)
Maximum Voltage-Temperature Coefficient	< -0.01 % / °C
Insulation Resistance	1000 Megohm min.
Hi POT (Leads to Case, 1 min.)	2500 VDC (Phenolic coating 500 VDC and 2000 VDC ratings)
Typical Response Time	< 15 nsec.
Epoxy Rating	94 V-0
Current/Energy Derating (>85°C)	- 2.5 % / °C
DC Leakage Current	200µA Max (at rated DC working voltage)
Solderability	MIL STD 202G, Method 208H
Failure Criteria	Voltage change ± 10% from initially measured Varistor Voltage. When determining if varistor is within aforementioned criteria the same temperature must be observed as was used for initial Varistor Voltage measurements.

## Part Marking

Example: 20E241K-VB

<b>20</b>	<b>E</b>	<b>241</b>	<b>K</b>	<b>- N</b>	<b>B</b>
(1)	(2)	(3)	(4)	(5)	(6)

### (1) Disk Diameter

5 = 5mm, 7 = 7mm, 10 = 10mm,  
 14 = 14mm, 18 = 18mm, 20 = 20mm,  
 25 = 25mm, 32 = 32mm, 34 = 34mm,  
 40 = 40mm, 53 = 53mm

### (2) Type

**D** = Standard  
**E** = High Energy  
**R** = (applicable only for 34mm Types)

### (3) Varistor Voltage

**241** =  $24 \times 10^1 = 240$

### (4) Tolerance

**J** = ±5%, **K** = ±10%, **M** = ±20%

(5) **N** = RoHs Compliant Series (as of October 2007 forward, per Date Code)

(6) **B** = Phenolic coating rated at 500 VDC. Phenolic coating rated at 2000 VDC requires no marking.

### Date Code

037 = First digit represents year (0 = 2010). Second and third digits represent the week of the year. This new date code system was implemented from 9/15/05.

**NOTE:** Parts will be marked **SINCERA**. (This is the brand name.)

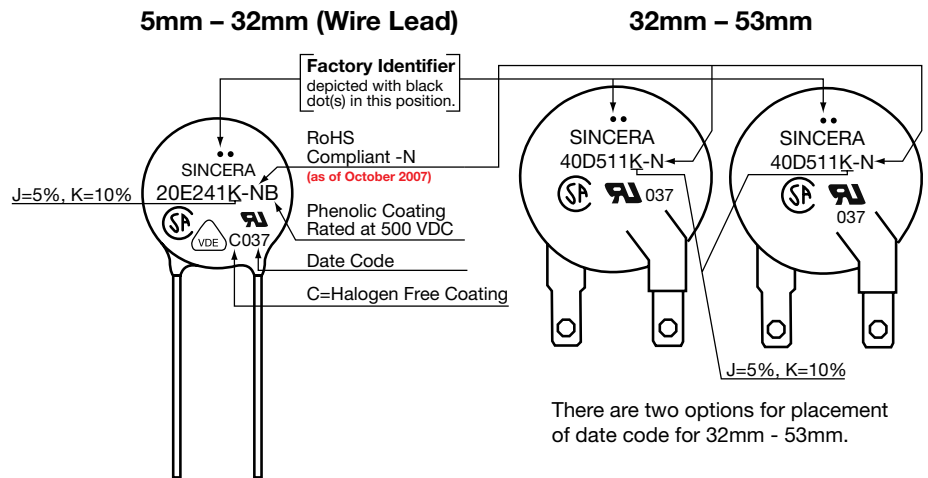

## Approvals

APPROVAL & FILE #	DISK SIZE / SERIES															
	5mm "D" Series		5mm "E" Series		7mm "D" Series		7mm "E" Series		10mm "D" Series		10mm "E" Series		14mm "D" Series		14mm "E" Series	
	TYPE		TYPE		TYPE		TYPE		TYPE		TYPE		TYPE		TYPE	
	PB	RoHS	PB	RoHS	PB	RoHS	PB	RoHS	PB	RoHS	PB	RoHS	PB	RoHS	PB	RoHS
UL/CUL 1449 3RD EDITION, FILE#E321567*	N/A <sup>(1)</sup>	√	N/A <sup>(1)</sup>	511K, 581K, 621K, 681K NOT APPROVED	N/A <sup>(1)</sup>	√	N/A <sup>(1)</sup>	√	N/A <sup>(1)</sup>	√	N/A <sup>(1)</sup>	√	N/A <sup>(1)</sup>	√	N/A <sup>(1)</sup>	√
UL1414** (VALUES ≥201K) FILE #E71602	√	√	√	√	√	√	√	√	√	√	√	√	√	√	√	√
CSA22.1 #1 (VALUES ≥201K) FILE #227006	√	√	√	√	√	√	√	√	√	√	√	√	√	√	√	√
CSA 22.2 #1 FILE #241120																
VDE FILE #40012632					√	√			√	√			√	√		
VDE FILE #40012630							√	√			√	√			√	√
VDE FILE #40028559 ANNEX Q <sub>2</sub>															N/A <sup>(1)</sup>	√
VDE FILE #40028554 ANNEX Q <sub>2</sub>													N/A <sup>(1)</sup>	√		
COMPLIES WITH UL ACCELERATED AGING TEST PU: ANSI/IEEE C62.11 FILE #E196885																
COMPLIES WITH UL ACCELERATED AGING TEST PER: ANSI/IEEE C62.11 FILE #E321567	N/A <sup>(1)</sup>		N/A <sup>(1)</sup>		N/A <sup>(1)</sup>		N/A <sup>(1)</sup>		N/A <sup>(1)</sup>		N/A <sup>(1)</sup>		N/A <sup>(1)</sup>		N/A <sup>(1)</sup>	

**NOTES:**

(1) N/A - Denotes "not applicable".

(2) IEC 61051-1:2007-04, IEC 61051-2:1991-01, IEC 61051-2-2: 1991-01

\*UL 1449 3rd Edition parts are recognized to SPD Application Category Types:

VZ05-VZ10 both "D" & "E" types (ALL), VZ14D (ALL), VZ14E (180-680 values only), and VZ20D (180-680 values only) – other.

VZ14E (820-112 values only) – Type 3.

VZ20D (820-112 values only) – Type 2.

VZ18E, VZ 20E and VZ25D – Type 2.

VZ32D - VZ53D – Type 1.

\*\*Metal Oxide Varistors will not be recognized to UL1414 from December 25, 2013.

Approvals stated above are for "series types" as stated. Modification to the above "series types" denoted by special suffixes may vary with regards to above stated approvals. Please consult the Part Numbering System portion of the catalog for this information.

Approvals

APPROVAL & FILE #	DISK SIZE / SERIES																	
	18mm "E" Series		20mm "D" Series		20mm "E" Series		25mm "D" Series		25mm "R" Series		32mm		34mm		40mm		53mm	
	TYPE		TYPE		TYPE		TYPE		TYPE		TYPE		TYPE		TYPE		TYPE	
	PB	RoHS	PB	RoHS	PB	RoHS	PB	RoHS	PB	RoHS	PB	RoHS	PB	RoHS	PB	RoHS	PB	RoHS
UL/CUL 1449 3RD EDITION, FILE#...E321567*	N/A <sup>(1)</sup>	√	N/A <sup>(1)</sup>	√	N/A <sup>(1)</sup>	√	N/A <sup>(1)</sup>	√	N/A <sup>(1)</sup>	√	N/A <sup>(1)</sup>	√ <sup>(2)</sup>	N/A <sup>(1)</sup>	√ <sup>(2)</sup>	N/A <sup>(1)</sup>	√ <sup>(2)</sup>	N/A <sup>(1)</sup>	√ <sup>(2)</sup>
UL1414** (VALUES ≥201K) FILE #E71602	√	√	√	√	√	√												
CSA 22.1 #1 (VALUES ≥201K) FILE #227006	√	√	√	√	√	√	√	√										
CSA 22.2 #1 FILE #241120											√	√	√	√	√	√	√	√
VDE FILE #40012632			√	√														
VDE FILE #40012630	√	√																
VDE FILE #40028559 ANNEX Q <sup>(3)</sup>	N/A <sup>(1)</sup>	√			N/A <sup>(1)</sup>	√												
VDE FILE #40028554 ANNEX Q <sup>(3)</sup>																		
COMPLIES WITH UL ACCELERATED AGING TEST PU: ANSI/IEEE C62.11 FILE #E196885	√	√			√	√			√	√			√	√				
COMPLIES WITH UL ACCELERATED AGING TEST PER: ANSI/IEEE C62.11 FILE #E321567	N/A <sup>(1)</sup>	VALUES 820K - 241K NOT APPROVED	N/A <sup>(1)</sup>		N/A <sup>(1)</sup>	VALUES 820K & 751K - 112K ONLY	N/A <sup>(1)</sup>	√				N/A <sup>(1)</sup>	N/A <sup>(1)</sup>		N/A <sup>(1)</sup>		N/A <sup>(1)</sup>	

NOTES:

(1) N/A - Denotes "not applicable".

(2) 32mm (wire lead type - suffix "KW") is not recognized at this time. The following types are not CUL recognized: 32mm (122K & 152K), 34mm (single disk - 122K), 34mm (dual disk - 122K), 40mm (122K & 152K), 53mm (301K thru 471K).

(3) IEC 61051-1:2007-04, IEC 61051-2:1991-01, IEC 61051-2-2: 1991-01

\*UL 1449 3rd Edition parts are recognized to SPD Application Category Types:

VZ05-VZ10 both "D" & "E" types (ALL), VZ14D (ALL), VZ14E (180-680 values only), and VZ20D (180-680 values only). - other.

VZ14E (820-112 values only) - Type 3.

VZ20D (820-112 values only) - Type 2.

VZ18E, VZ 20E and VZ25D - Type 2.

VZ32D - VZ53D - Type 1.

\*\*Metal Oxide Varistors will not be recognized to UL1414 from December 25, 2013.

Approvals stated above are for "series types" as stated. Modification to the above "series types" denoted by special suffixes may vary with regards to above stated approvals. Please consult the Part Numbering System portion of the catalog for this information.

## Part Number System

Example: VZ20D241KBOCX-VPN

<u>V</u>	<u>Z</u>	<u>20</u>	<u>E</u>	<u>241</u>	<u>K</u>	<u>B</u>	<u>O</u>	<u>C</u>	<u>X</u>	-	<u>V</u>	<u>P</u>	<u>N</u>
(1)	(2)	(3)	(4)	(5)	(6)	(7)	(8)	(9)	(10)		(11)	(12)	(13)

**(1) Series**

V = Varistor

**(2) Type**

Z = Zinc Oxide

**(3) Disk Diameter**

05 = 5mm, 07 = 7mm, 10 = 10mm, 14 = 14mm,  
18 = 18mm, 20 = 20mm, 25 = 25mm, 32 = 32mm,  
34 = 34mm, 40 = 40mm, 53 = 53mm

**(4) Type**

D = Standard

E = High Energy Type

R = (applicable only for 34mm Types)

**(5) Varistor Voltage**

241 =  $24 \times 10^1 = 240$  (DC Volts)

**(6) Tolerance**

J = 5%, K = 10%

**(7) Packing Code**

B = Bulk Pack

(For taped parts packing code, see Taping Specifications.)

Note: For sizes 32 and larger please reference specification pages for fields beyond (6).

**(8) Lead Configuration (For Bulk Parts)**

S = Straight

O = Outward Crimp

I = Inward Crimp

L = Inline Crimp

N = Bulk parts for 320VAC and larger come standard with inline crimp (see illustration below) for straight disk seating on PC boards. If straight leads are required instead of inline crimp please use code "N" in the appropriate position as stated above.

Note: Also applicable for 32mm (KW Series) with wire leads.

R = Bare disk without leads (no epoxy).

Available in 20mm & 25mm disk sizes\*\* (RoHS Compliant).

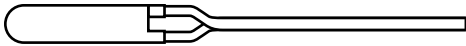

\* Compliant with Directive 2002/95/EC of the European Parliament and of the Council of 27 January 2003 on the restriction of the use of certain hazardous substances in electrical and electronic equipment (RoHS Directive). Please note solderability profile on page 107.

\*\* 32mm – 53mm types are also available as bare disk with and without leads. Reference suffix codes stated in Electrical/Dimensions section for these types in this catalog.

**(9) Lead Cutting**

A =  $4.0 \pm 1.0\text{mm}$  (.16"  $\pm$  .04")  
(Crimped lead)

B =  $3.0 \pm 1.0\text{mm}$  (.12"  $\pm$  .04")  
(Crimped lead)

C =  $4.5 \pm 1.5\text{mm}$  (.18"  $\pm$  .06")  
(Crimped lead)

D =  $6.5 \pm 1.0\text{mm}$  (.26"  $\pm$  .04")  
(Crimped lead)

E =  $4.0 \pm 1.0\text{mm}$  (.18"  $\pm$  .04")  
(Straight lead)

F =  $5.0 \pm 1.0\text{mm}$  (.2"  $\pm$  .04")  
(Crimped lead)

G =  $3.3 \pm 0.5\text{mm}$  (.13"  $\pm$  .02")  
(Crimped lead)

(For lead length reference points see Standard Lead Modifications).

Note: Also applicable for 32mm (KW Series) with wire leads.

**(10) Lead Spacing**

X = 10mm (0.4") lead spacing 1mm (0.039") lead diameter.  
(For 18mm and 20mm disk diameter only.)

Z = 5mm (0.2") leadspacing.  
(For 10mm and 14mm disk diameters.)

**(11) Extremely High Energy Rating**

V = 15KA for 20mm, 12KA for 18mm and 7.5KA for 14mm, "E Series" parts only. Available in varistor voltages 14mm and 20mm (181-112), 18mm (181-781) (UL1414 and UL1449 3rd Edition recognized parts). CSA recognized for 14, 18 & 20mm "E Series" parts all values  $\geq 201$  with the exception of 14E (911, 102 & 112). 14E "V" series parts are rated at 7.5KA. (If you have a special voltage request, please inquire).\*\*\*

**(12) Coating Option**

P = Phenolic Coating with 2000VDC rating. Applicable for UL1414 (5mm – 20mm), UL1449 3rd Edition (14mm, 18mm and 20mm "V" type only), and CSA (5mm – 20mm) recognized parts.\*\*\*

B = Phenolic Coating with 500VDC rating. Applicable for UL1414 (5mm – 20mm) and CSA (5mm - 20mm) recognized parts.\*\*\*

Y = Bare disk with leads (no epoxy).

Available in 20mm & 25mm disk size\*\* (RoHS Compliant 20E suffix "V" 181K - 471K CSA c/us certified File #154862).

C = Halogen Free Coating. Applicable for UL1449 (3rd Edition), UL1414, (5mm-20mm), CSA (5mm-25mm) and VDE (14D, 14E, 18E and 20E only).\*\*\*

**(13) RoHS Compliant\***

N = RoHS Compliant

(Available in disk sizes 5mm – 53mm)

\*\*\*Metal Oxide Varistors may not be recognized to UL1414 from December 25, 2013.



## Standard Dimensions and Lead Modification Options

+ Dmax for Phenolic "P" Type is 8mm (.31").

\* For 10mm lead spacing use suffix "X" for bulk parts (18mm and 20mm disk diameter)

### Straight Leads

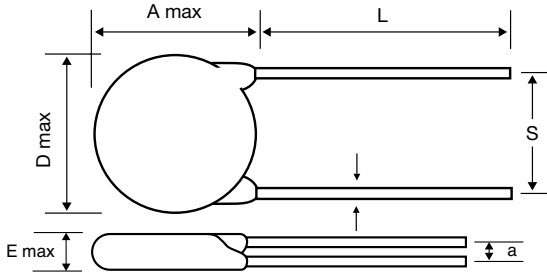

### Inward Crimp

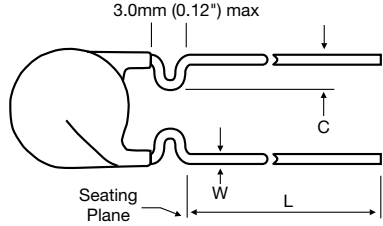

### Outward Crimp

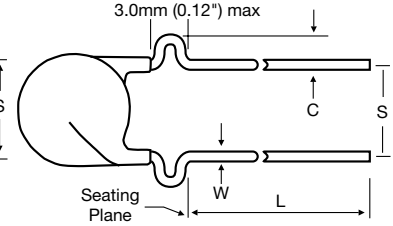

### Inline Crimp

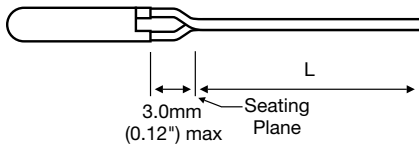

### 25R Series

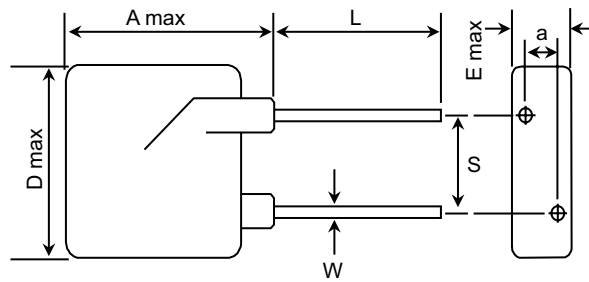

Dimensions of Bare Disk	
Disk Size	D
20mm	20.0±1.0mm
25mm	25.0±1.0mm

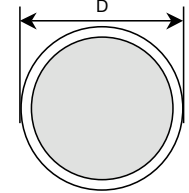

Disk Size	A max		D max		S		W nom		C		L	Dimension E max and a
	mm	in	mm	in	mm ± 1	in ± .04	mm ± .02	in ± .001	mm	in		
5	10.0	0.4	+7.0	+0.28	5.0	0.2	0.6	0.024	1.6 ± 0.4	0.06 ± 0.016	For other than standard (straight lead) lead length, please see Definitions, "Part Number System" "(9) Lead Cutting" for specs and suffix codes.	Please see E Maximum Thickness and Off-set (a) Dimension by Part Number (Next Page)
7	12.0	0.47	9.5	0.37	5.0	0.2	0.6	0.024	1.6 ± 0.4	0.06 ± 0.016		
10	17.0	0.67	12.5	0.49	7.5	0.3	0.8	0.031	1.6 ± 0.4	0.06 ± 0.016		
14	20.5	0.8	16.5	0.65	7.5	0.3	0.8	0.031	1.6 ± 0.4	0.06 ± 0.016		
18	24.0	0.94	20.0	0.79	7.5	0.3	0.8	0.031	2.05 ± 0.4	0.08 ± 0.016		
18*	24.0	0.94	20.0	0.79	10.0	0.4	1.0	0.039	2.05 ± 0.4	0.08 ± 0.016		
20	28.0	1.10	24.0	0.94	7.5	0.3	0.8	0.031	2.05 ± 0.4	0.08 ± 0.016		
20*	28.0	1.10	24.0	0.94	10.0	0.4	1.0	0.039	2.05 ± 0.4	0.08 ± 0.016		
25	31.75	1.25	27.9	1.10	12.7	0.5	1.0	0.039	2.05 ± 0.4	0.08 ± 0.016		
25R	34.5	1.35	29.0	1.14	12.7 ± 1	0.5	1.0 ± 0.2	0.040			20.0	
32KW (wire lead)	45.0	1.77	40.0	1.57	22.5 ± 1.5	0.9 ± 0.059	1.5 ± 0.5	0.06 ± 0.02				For other than standard (straight lead) lead length, please see Definitions, "Part Number System" "(9) Lead Cutting" for specs and suffix codes.

**Notes:**

- Maximum epoxy extending on leads (measured from bottom most portion of disk) is 3mm for all disk sizes with exception of 20mm, 25mm and 32mm disk sizes which are 4mm.
- Reduced dimensions, special lead diameters and special lead spacing may be available upon request.
- Bulk parts for 320VAC and larger come standard with inline crimp (as referenced above) for straight disk seating on PC boards. If 320VAC and larger size are required without in-line crimp, please reference "Part Number System" position # (8) and add "N" and reference "a" off-set dimensions.
- The maximum straight lead length available for 5mm leadspacing is 40mm max, 7.5mm leadspacing is 32mm max, 10mm leadspacing is 35mm max.

**Standard Dimensions and Lead Modification Options (continued)**

**E Max Dimensions (For Standard Epoxy)**

Dimensions are in mm (inches)

**5D Series**

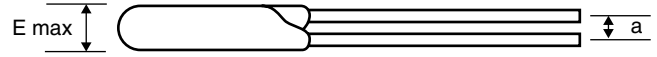

Style	E Max mm (in)	Off-set Dimension (a) ±1 (±0.04) mm (in)
5D180K	3.4 (.13)	1.2 (.05)
5D220K	3.6 (.14)	1.3 (.05)
5D270K	3.8 (.15)	1.4 (.055)
5D330K	3.9 (.15)	1.2 (.05)
5D390K	4.0 (.16)	1.3 (.05)
5D470K	3.8 (.15)	1.5 (.06)
5D560K	3.9 (.15)	1.6 (.063)
5D680K	4.2 (.165)	1.8 (.07)
5D820K	3.4 (.13)	1.2 (.05)
5D101K	3.6 (.14)	1.2 (.05)
5D121K	3.8 (.15)	1.3 (.05)
5D151K	3.9 (.15)	1.3 (.05)
5D181K	3.5 (.138)	1.5 (.06)
5D201K	3.6 (.14)	1.6 (.063)

Style	E Max mm (in)	Off-set Dimension (a) ±1 (±0.04) mm (in)
5D221K	3.6 (.14)	1.6 (.063)
5D241K	3.7 (.145)	1.8 (.07)
5D271K	3.8 (.15)	2.0 (.08)
5D301K	3.9 (.15)	2.3 (.09)
5D331K	4.1 (.16)	2.4 (.094)
5D361K	4.4 (.17)	2.5 (.1)
5D391K	4.5 (.18)	2.7 (.1)
5D431K	4.7 (.185)	2.9 (.11)
5D471K	4.9 (.19)	3.6 (.14)
5D511K	5.1 (.2)	*3.1 (.12)
5D561K	5.3 (.21)	*3.3 (.13)
5D621K	5.5 (.22)	*3.9 (.15)
5D681K	5.7 (.22)	*4.3 (.17)

**7D Series**

Style	E Max mm (in)	Off-set Dimension (a) ±1 (±0.04) mm (in)
7D180K	3.4 (.13)	1.2 (.05)
7D220K	3.6 (.14)	1.3 (.05)
7D270K	3.8 (.15)	1.4 (.055)
7D330K	3.9 (.15)	1.2 (.05)
7D390K	4.0 (.16)	1.3 (.05)
7D470K	3.8 (.15)	1.5 (.06)
7D560K	3.9 (.15)	1.6 (.063)
7D680K	4.2 (.165)	1.8 (.07)
7D820K	3.4 (.13)	1.2 (.05)
7D101K	3.6 (.14)	1.2 (.05)
7D121K	3.8 (.15)	1.3 (.05)
7D151K	3.9 (.15)	1.3 (.05)
7D181K	3.5 (.138)	1.5 (.06)
7D201K	3.6 (.14)	1.6 (.063)

Style	E Max mm (in)	Off-set Dimension (a) ±1 (±0.04) mm (in)
7D221K	3.6 (.14)	1.6 (.063)
7D241K	3.7 (.145)	1.8 (.07)
7D271K	3.8 (.15)	2.0 (.08)
7D301K	3.9 (.15)	2.3 (.09)
7D331K	4.1 (.16)	2.4 (.094)
7D361K	4.4 (.17)	2.5 (.1)
7D391K	4.5 (.18)	2.7 (.1)
7D431K	4.7 (.185)	2.9 (.11)
7D471K	4.9 (.19)	3.6 (.14)
7D511K	5.1 (.2)	*3.1 (.12)
7D561K	5.3 (.21)	*3.3 (.13)
7D621K	5.5 (.22)	*3.9 (.15)
7D681K	5.7 (.22)	*4.3 (.17)

\* Bulk parts for 320VAC and larger come standard with inline crimp (as referenced at beginning of “Standard Dimensions and Lead Modification Options” section ) for straight disk seating on PC boards. Therefore, “a” dimension is not applicable. If 320VAC and larger size are required without in-line crimp, please reference “Part Number System” position # (8) and add “N” and reference “a” dimensions (for off-set) above.

## Standard Dimensions and Lead Modification Options (continued)

### E Max Dimensions (For Standard Epoxy)

Dimensions are in mm (inches)

#### 10D Series



Style	E Max mm (in)	Off-set Dimension (a) ±1 (±0.04) mm (in)
10D180K	3.8 (.15)	1.4 (.055)
10D220K	4.0 (.16)	1.5 (.06)
10D270K	4.2 (.165)	1.6 (.063)
10D330K	4.3 (.17)	1.8 (.07)
10D390K	4.4 (.17)	1.6 (.063)
10D470K	4.4 (.17)	1.7 (.067)
10D560K	4.4 (.17)	1.8 (.07)
10D680K	4.6 (.18)	2.1 (.083)
10D820K	3.8 (.15)	1.4 (.055)
10D101K	3.8 (.15)	1.4 (.055)
10D121K	4.0 (.16)	1.5 (.06)
10D151K	4.2 (.165)	1.5 (.06)
10D181K	4.2 (.165)	1.6 (.063)
10D201K	4.2 (.165)	1.8 (.07)
10D221K	4.1 (.16)	1.8 (.07)
10D241K	4.2 (.165)	2.0 (.08)
10D271K	4.3 (.17)	2.2 (.087)

Style	E Max mm (in)	Off-set Dimension (a) ±1 (±0.04) mm (in)
10D301K	4.4 (.17)	2.5 (.1)
10D331K	4.6 (.18)	2.5 (.1)
10D361K	4.9 (.19)	2.7 (.1)
10D391K	5.0 (.2)	2.9 (.11)
10D431K	5.2 (.2)	3.1 (.12)
10D471K	5.4 (.21)	3.6 (.14)
10D511K	5.5 (.22)	*3.4 (.13)
10D561K	5.8 (.23)	*3.5 (.138)
10D621K	6.1 (.24)	*4.2 (.165)
10D681K	6.4 (.25)	*4.6 (.18)
10D751K	6.7 (.26)	*5.0 (.197)
10D781K	6.9 (.27)	*5.0 (.197)
10D821K	7.1 (.28)	*5.4 (.2)
10D911K	7.5 (.3)	*5.9 (.23)
10D102K	7.6 (.3)	*6.4 (.25)
10D112K	7.8 (.31)	*7.0 (.275)

#### 14D Series

Style	E Max mm (in)	Off-set Dimension (a) ±1 (±0.04) mm (in)
14D180K	3.9 (.15)	1.4 (.055)
14D220K	4.1 (.16)	1.5 (.06)
14D270K	4.3 (.17)	1.7 (.067)
14D330K	4.5 (.18)	1.9 (.075)
14D390K	4.5 (.18)	1.7 (.067)
14D470K	4.3 (.17)	1.8 (.07)
14D560K	4.5 (.18)	2.0 (.08)
14D680K	4.7 (.185)	2.2 (.087)
14D820K	3.8 (.15)	1.4 (.055)
14D101K	3.8 (.15)	1.5 (.06)
14D121K	4.0 (.16)	1.5 (.06)
14D151K	4.2 (.165)	1.5 (.06)
14D181K	4.4 (.17)	1.7 (.067)
14D201K	4.6 (.18)	1.9 (.075)
14D221K	4.1 (.16)	1.9 (.075)
14D241K	4.2 (.165)	2.1 (.083)
14D271K	4.3 (.17)	2.2 (.087)

Style	E Max mm (in)	Off-set Dimension (a) ±1 (±0.04) mm (in)
14D301K	4.4 (.17)	2.6 (.1)
14D331K	4.6 (.18)	2.6 (.1)
14D361K	4.9 (.19)	2.8 (.11)
14D391K	5.0 (.2)	3.0 (.12)
14D431K	5.2 (.2)	3.2 (.126)
14D471K	5.4 (.21)	3.8 (.15)
14D511K	5.5 (.22)	*3.4 (.13)
14D561K	5.8 (.23)	*3.5 (.138)
14D621K	6.1 (.24)	*4.2 (.165)
14D681K	6.4 (.25)	*4.7 (.185)
14D751K	6.7 (.26)	*5.1 (.2)
14D781K	6.9 (.27)	*5.1 (.2)
14D821K	7.1 (.28)	*5.5 (.22)
14D911K	7.5 (.3)	*6.0 (.24)
14D102K	7.6 (.3)	*6.5 (.255)
14D112K	8.0 (.31)	*7.2 (.28)

\* Bulk parts for 320VAC and larger come standard with inline crimp (as referenced at beginning of "Standard Dimensions and Lead Modification Options" section ) for straight disk seating on PC boards. Therefore, "a" dimension is not applicable. If 320VAC and larger size are required without in-line crimp, please reference "Part Number System" position # (8) and add "N" and reference "a" dimensions (for off-set) above.

**Standard Dimensions and Lead Modification Options (continued)**

**E Max Dimensions (For Standard Epoxy)**

Dimensions are in mm (inches)

**20D Series**

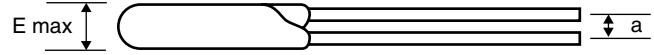

Style	E Max mm (in)	Off-set Dimension (a) ±1 (±0.04) mm (in)
20D180K	4.3 (.17)	1.5 (.06)
20D220K	4.5 (.18)	1.6 (.063)
20D270K	4.7 (.185)	1.8 (.07)
20D330K	4.9 (.19)	2.1 (.083)
20D390K	5.1 (.2)	2.1 (.083)
20D470K	5.3 (.21)	2.2 (.087)
20D560K	5.5 (.22)	2.2 (.087)
20D680K	5.7 (.22)	2.4 (.094)
20D820K	4.3 (.17)	1.5 (.06)
20D101K	4.3 (.17)	1.6 (.063)
20D121K	4.4 (.17)	1.6 (.063)
20D151K	4.6 (.18)	1.6 (.063)
20D181K	4.6 (.18)	1.8 (.07)
20D201K	4.7 (.185)	2.0 (.08)
20D221K	4.8 (.19)	2.0 (.08)
20D241K	4.9 (.19)	2.2 (.087)
20D271K	4.9 (.19)	2.3 (.09)

Style	E Max mm (in)	Off-set Dimension (a) ±1 (±0.04) mm (in)
20D301K	5.0 (.2)	2.6 (.1)
20D331K	5.0 (.2)	2.7 (.1)
20D361K	5.4 (.21)	2.9 (.11)
20D391K	5.5 (.22)	3.1 (.12)
20D431K	5.7 (.22)	3.3 (.13)
20D471K	5.5 (.22)	4.0 (.157)
20D511K	5.7 (.22)	*3.4 (.13)
20D561K	5.9 (.23)	*3.8 (.15)
20D621K	6.2 (.24)	*4.5 (.18)
20D681K	6.5 (.26)	*4.8 (.19)
20D751K	6.8 (.27)	*5.2 (.2)
20D781K	7.0 (.275)	*5.4 (.2)
20D821K	7.2 (.28)	*5.6 (.22)
20D911K	7.5 (.3)	*6.5 (.255)
20D102K	7.9 (.31)	*6.6 (.26)
20D112K	8.4 (.33)	*7.3 (.287)

**25D Series**

Style	E Max mm (in)	Off-set Dimension (a) ±1 (±0.04) mm (in)
25D181K	4.8 (.19)	2.2 (.087)
25D201K	5.0 (.2)	2.2 (.087)
25D221K	5.0 (.2)	2.2 (.087)
25D241K	5.3 (.21)	2.4 (.094)
25D271K	5.5 (.22)	2.5 (.1)
25D301K	5.6 (.22)	2.7 (.1)
25D331K	5.9 (.23)	2.8 (.11)
25D361K	5.9 (.23)	3.0 (.12)
25D391K	6.0 (.24)	3.3 (.13)
25D431K	6.5 (.256)	3.5 (.138)
25D471K	6.5 (.26)	5.0 (.197)

Style	E Max mm (in)	Off-set Dimension (a) ±1 (±0.04) mm (in)
25D511K	6.8 (.27)	*3.5 (.138)
25D561K	7.0 (.275)	*3.9 (.15)
25D621K	7.4 (.29)	*4.8 (.19)
25D681K	7.5 (.29)	*5.0 (.197)
25D751K	7.6 (.30)	*5.4 (.2)
25D781K	8.0 (.31)	*5.5 (.22)
25D821K	8.2 (.32)	*5.8 (.23)
25D911K	8.2 (.32)	*7.0 (.275)
25D102K	8.8 (.35)	*7.2 (.28)
25D112K	9.4 (.37)	*7.4 (.29)

\* Bulk parts for 320VAC and larger come standard with inline crimp (as referenced at beginning of “Standard Dimensions and Lead Modification Options” section ) for straight disk seating on PC boards. Therefore, “a” dimension is not applicable. If 320VAC and larger size are required without in-line crimp, please reference “Part Number System” position # (8) and add “N” and reference “a” dimensions (for off-set) above.

## Standard Dimensions and Lead Modification Options (continued)

### E Max Dimensions (For Standard Epoxy)

Dimensions are in mm (inches)

#### 25R Series



Style	E Max mm (in)	Off-set Dimension (a) ±1 (±0.04) mm (in)
25R181KBS	5.75 (.23)	2.55 (.10)
25R201KBS	5.92 (.23)	2.72 (.11)
25R221KBS	6.08 (.24)	2.88 (.11)
25R241KBS	6.25 (.25)	3.05 (.12)
25R271KBS	5.80 (.23)	2.60 (.10)
25R301KBS	5.98 (.23)	2.78 (.11)
25R331KBS	6.15 (.24)	2.95 (.12)
25R361KBS	6.35 (.25)	3.15 (.12)
25R391KBS	6.50 (.25)	3.30 (.13)
25R431KBS	6.75 (.27)	3.55 (.14)
25R471KBS	7.00 (.28)	3.80 (.15)

Style	E Max mm (in)	Off-set Dimension (a) ±1 (±0.04) mm (in)
25R511KBS	7.20 (.28)	4.00 (.158)
25R561KBS	7.50 (.30)	4.30 (.17)
25R621KBS	7.85 (.30)	4.65 (.20)
25R681KBS	8.20 (.32)	5.00 (.20)
25R751KBS	8.28 (.32)	5.08 (.20)
25R781KBS	8.47 (.33)	5.27 (.20)
25R821KBS	8.70 (.34)	5.50 (.21)
25R911KBS	9.18 (.36)	5.98 (.23)
25R102KBS	9.66 (.39)	6.46 (.25)
25R112KBS	10.20 (.40)	7.00 (.27)
25R122KBS	10.70 (.42)	7.50 (.30)

#### 32D Series

Style	E Max mm (in)	Off-set Dimension (a) ±1 (±0.04) mm (in)
32D201KW	5.6 (.22)	2.6 (.1)
32D221KW	5.7 (.22)	2.7 (.11)
32D241KW	5.8 (.23)	2.8 (.11)
32D271KW	5.9 (.23)	2.9 (.11)
32D331KW	6.3 (.25)	3.3 (.13)
32D361KW	6.5 (.255)	3.5 (.137)
32D391KW	6.6 (.26)	3.6 (.14)
32D431KW	6.8 (.27)	3.8 (.15)
32D471KW	6.9 (.27)	3.9 (.15)
32D511KW	7.3 (.29)	*4.3 (.17)
32D561KW	7.3 (.29)	*4.3 (.17)

Style	E Max mm (in)	Off-set Dimension (a) ±1 (±0.04) mm (in)
32D621KW	7.9 (.31)	*4.9 (.19)
32D681KW	8.1 (.32)	*5.1 (.2)
32D751KW	8.5 (.33)	*5.5 (.216)
32D781KW	8.7 (.34)	*5.7 (.22)
32D821KW	9.0 (.35)	*6.0 (.236)
32D911KW	9.4 (.37)	*6.4 (.25)
32D951KW	9.8 (.39)	*6.7 (.26)
32D102KW	10.0 (.39)	*7.0 (.275)
32D112KW	10.5 (.41)	*7.5 (.295)
32D122KW	11.0 (.43)	*8.0 (.31)
32D152KW	12.5 (.49)	*9.5 (.37)

\* Bulk parts for 320VAC and larger come standard with inline crimp (as referenced at beginning of “Standard Dimensions and Lead Modification Options” section ) for straight disk seating on PC boards. Therefore, “a” dimension is not applicable. If 320VAC and larger size are required without in-line crimp, please reference “Part Number System” position # (8) and add “N” and reference “a” dimensions (for off-set) above.

## Standard Dimensions and Lead Modification Options (continued)

### E Max Dimensions (For Standard Epoxy)

Dimensions are in mm (inches)

#### 5E High Energy Series

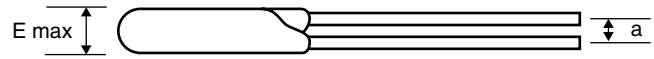

Style	E Max mm (in)	Off-set Dimension (a) ±1 (±0.04) mm (in)
5E820K	3.4 (.13)	1.2 (.05)
5E181K	3.5 (.138)	1.5 (.06)
5E201K	3.6 (.14)	1.6 (.063)
5E221K	3.6 (.14)	1.6 (.063)
5E241K	3.7 (.145)	1.8 (.07)
5E271K	3.8 (.15)	2.0 (.08)

Style	E Max mm (in)	Off-set Dimension (a) ±1 (±0.04) mm (in)
5E331K	4.1 (.16)	2.4 (.094)
5E361K	4.4 (.17)	2.5 (.1)
5E391K	4.5 (.18)	2.7 (.1)
5E431K	4.7 (.185)	2.9 (.11)
5E471K	4.9 (.19)	3.6 (.14)

#### 7E High Energy Series

Style	E Max mm (in)	Off-set Dimension (a) ±1 (±0.04) mm (in)
7E820K	3.4 (.13)	1.2 (.05)
7E181K	3.5 (.138)	1.5 (.06)
7E201K	3.6 (.14)	1.6 (.063)
7E221K	3.6 (.14)	1.6 (.063)
7E241K	3.7 (.145)	1.8 (.07)
7E271K	3.8 (.15)	2.0 (.08)

Style	E Max mm (in)	Off-set Dimension (a) ±1 (±0.04) mm (in)
7E331K	4.1 (.16)	2.4 (.094)
7E361K	4.4 (.17)	2.5 (.1)
7E391K	4.5 (.18)	2.7 (.1)
7E431K	4.7 (.185)	2.9 (.11)
7E471K	4.9 (.19)	3.6 (.14)

#### 10E High Energy Series

Style	E Max mm (in)	Off-set Dimension (a) ±1 (±0.04) mm (in)
10E820K	3.8 (.15)	1.4 (.055)
10E181K	4.2 (.165)	1.8 (.07)
10E201K	4.2 (.165)	1.8 (.07)
10E221K	4.1 (.16)	1.8 (.07)
10E241K	4.2 (.165)	2.0 (.08)
10E271K	4.3 (.17)	2.2 (.087)
10E331K	4.6 (.18)	2.5 (.1)

Style	E Max mm (in)	Off-set Dimension (a) ±1 (±0.04) mm (in)
10E361K	4.9 (.19)	2.7 (.1)
10E391K	5.0 (.2)	2.9 (.11)
10E431K	5.2 (.2)	3.1 (.12)
10E471K	5.4 (.21)	3.6 (.14)
10E511K	5.5 (.22)	*3.4 (.13)
10E561K	5.8 (.23)	*3.5 (.138)
10E821K	7.1 (.28)	*5.4 (.2)

\* Bulk parts for 320VAC and larger come standard with inline crimp (as referenced at beginning of “Standard Dimensions and Lead Modification Options” section ) for straight disk seating on PC boards. Therefore, “a” dimension is not applicable. If 320VAC and larger size are required without in-line crimp, please reference “Part Number System” position # (8) and add “N” and reference “a” dimensions (for off-set) above.

\*\* For suffix “V” (Extremely High Energy Type) add 0.1 (0.004) to “E Max.”

**Standard Dimensions and Lead Modification Options (continued)**

**E Max Dimensions (For Standard Epoxy)**

Dimensions are in mm (inches)

**14E High Energy Series**

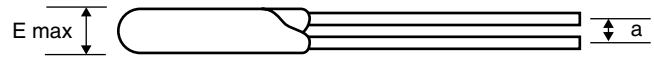

Style	E Max mm (in)	Off-set Dimension (a) ±1 (±0.04) mm (in)
**14E820K	3.8 (.15)	1.4 (.055)
**14E181K	4.4 (.17)	1.7 (.067)
**14E201K	4.6 (.18)	1.9 (.075)
**14E221K	4.5 (.18)	1.9 (.075)
**14E241K	4.5 (.18)	2.1 (.083)
**14E271K	4.5 (.18)	2.2 (.087)
**14E331K	4.6 (.18)	2.6 (.1)

Style	E Max mm (in)	Off-set Dimension (a) ±1 (±0.04) mm (in)
**14E361K	4.9 (.19)	2.8 (.11)
**14E391K	5.0 (.2)	3.0 (.12)
**14E431K	5.2 (.2)	3.2 (.126)
**14E471K	5.4 (.21)	3.8 (.15)
**14E511K	5.5 (.22)	*3.4 (.13)
**14E561K	5.8 (.23)	*3.5 (.138)
**14E821K	7.1 (.28)	*5.5 (.22)

**18E High Energy Series**

Style	E Max mm (in)	Off-set Dimension (a) ±1 (±0.04) mm (in)
**18E820K	4.1 (.16)	1.5 (.06)
**18E181K	4.4 (.17)	1.9 (.075)
**18E201K	4.7 (.185)	1.9 (.075)
**18E221K	4.9 (.19)	1.9 (.075)
**18E241K	5.0 (.2)	2.0 (.08)
**18E271K	5.1 (.2)	2.2 (.08)
**18E301K	5.2 (.2)	2.3 (.09)
**18E331K	5.2 (.2)	2.7 (.11)
**18E361K	5.4 (.21)	2.8 (.11)
**18E391K	5.5 (.22)	3.0 (.12)
**18E431K	5.7 (.22)	3.2 (.126)

Style	E Max mm (in)	Off-set Dimension (a) ±1 (±0.04) mm (in)
**18E471K	5.8 (.23)	3.9 (.15)
**18E511K	6.1 (.24)	*3.4 (.13)
**18E561K	6.2 (.24)	*3.8 (.15)
**18E621K	6.2 (.24)	*3.2 (.13)
**18E681K	6.3 (.25)	*3.3 (.13)
**18E751K	6.5 (.26)	*3.5 (.14)
**18E781K	6.8 (.27)	*3.7 (.15)
**18E821K	7.4 (.29)	*5.5 (.22)
**18E911K	7.6 (.3)	*4.1 (.16)
**18E102K	7.9 (.31)	*4.4 (.18)
**18E112K	8.3 (.32)	*4.8 (.19)

**20E High Energy Series**

Style	E Max mm (in)	Off-set Dimension (a) ±1 (±0.04) mm (in)
**20E820K	4.3 (.17)	1.5 (.06)
**20E181K	4.6 (.18)	1.8 (.07)
**20E201K	4.9 (.19)	2.0 (.08)
**20E221K	5.0 (.2)	2.0 (.08)
**20E241K	5.1 (.2)	2.2 (.087)
**20E271K	5.4 (.21)	2.3 (.09)
**20E301K	5.5 (.22)	2.6 (.1)
**20E331K	5.8 (.23)	2.7 (.1)
**20E361K	5.4 (.21)	2.9 (.11)
**20E391K	5.5 (.22)	3.1 (.12)
**20E431K	5.7 (.22)	3.3 (.13)

Style	E Max mm (in)	Off-set Dimension (a) ±1 (±0.04) mm (in)
**20E471K	5.8 (.23)	4.0 (.157)
**20E511K	5.9 (.23)	*3.4 (.13)
**20E561K	5.9 (.23)	*3.8 (.15)
**20E621K	6.6 (.26)	*4.5 (.18)
**20E681K	6.9 (.27)	*4.8 (.19)
**20E751K	7.2 (.28)	*5.2 (.2)
**20E781K	7.4 (.29)	*5.4 (.2)
**20E821K	7.2 (.28)	*5.6 (.22)
**20E911K	8.0 (.32)	*6.5 (.255)
**20E102K	8.4 (.33)	*6.6 (.26)
**20E112K	8.4 (.33)	*7.3 (.287)

## Standard Dimensions and Lead Modification Options (continued)

### E Max Dimensions (For Phenolic Coating)

Dimensions are in mm (inches)

#### 5D Series

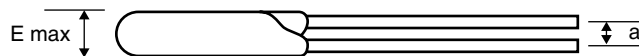

Style	E Max mm (in)		Off-set Dimension (a) ±1 (±0.04) mm (in)
	B	P	
5D180K	3.8 (.15)	5.0 (.196)	1.2 (.05)
5D220K	3.9 (.15)	5.1 (.2)	1.3 (.05)
5D270K	4.0 (.157)	5.2 (.2)	1.4 (.055)
5D330K	4.0 (.157)	5.2 (.2)	1.2 (.05)
5D390K	4.1 (.16)	5.3 (.21)	1.3 (.05)
5D470K	4.1 (.16)	5.3 (.21)	1.5 (.06)
5D560K	4.2 (.165)	5.4 (.21)	1.6 (.063)
5D680K	4.4 (.17)	5.8 (.23)	1.8 (.07)
**5D820K	3.8 (.15)	5.2 (.2)	1.2 (.05)
**5D101K	3.8 (.15)	5.2 (.2)	1.2 (.05)
**5D121K	3.9 (.15)	5.3 (.21)	1.3 (.05)
**5D151K	3.9 (.15)	5.3 (.21)	1.3 (.05)
**5D181K	4.1 (.16)	5.5 (.216)	1.5 (.06)
**5D201K	4.1 (.16)	5.5 (.216)	1.6 (.063)

Style	E Max mm (in)		Off-set Dimension (a) ±1 (±0.04) mm (in)
	B	P	
**5D221K	4.5 (.177)	5.4 (.21)	1.6 (.063)
**5D241K	4.7 (.185)	5.5 (.216)	1.8 (.07)
**5D271K	4.8 (.19)	5.5 (.216)	2.0 (.08)
**5D301K	4.9 (.19)	5.6 (.22)	2.3 (.09)
**5D331K	5.0 (.196)	5.6 (.22)	2.4 (.094)
**5D361K	5.1 (.2)	5.7 (.22)	2.5 (.1)
**5D391K	5.2 (.2)	5.9 (.23)	2.7 (.1)
**5D431K	5.3 (.21)	6.0 (.236)	2.9 (.11)
**5D471K	6.0 (.236)	7.2 (.28)	3.6 (.14)
5D511K	6.3 (.25)	7.5 (.295)	*3.1 (.12)
5D561K	5.5 (.216)	6.7 (.26)	*3.3 (.13)
5D621K	5.6 (.22)	6.8 (.267)	*3.9 (.15)
5D681K	5.9 (.23)	7.1 (.28)	*4.3 (.17)

#### 7D Series

Style	E Max mm (in)		Off-set Dimension (a) ±1 (±0.04) mm (in)
	B	P	
7D180K	3.9 (.15)	5.1 (.2)	1.2 (.05)
7D220K	4.0 (.157)	5.2 (.2)	1.3 (.05)
7D270K	4.1 (.16)	5.3 (.21)	1.4 (.055)
7D330K	4.1 (.16)	5.3 (.21)	1.2 (.05)
7D390K	4.2 (.165)	5.4 (.21)	1.3 (.05)
7D470K	4.2 (.165)	5.4 (.21)	1.5 (.06)
7D560K	4.4 (.17)	5.6 (.22)	1.6 (.063)
7D680K	4.6 (.18)	6.0 (.236)	1.8 (.07)
**7D820K	3.8 (.15)	5.2 (.2)	1.2 (.05)
**7D101K	3.8 (.15)	5.2 (.2)	1.2 (.05)
**7D121K	3.9 (.15)	5.3 (.21)	1.3 (.05)
**7D151K	3.9 (.15)	5.3 (.21)	1.3 (.05)
**7D181K	4.1 (.16)	5.5 (.216)	1.5 (.06)
**7D201K	4.1 (.16)	5.5 (.216)	1.6 (.063)

Style	E Max mm (in)		Off-set Dimension (a) ±1 (±0.04) mm (in)
	B	P	
**7D221K	4.5 (.177)	5.4 (.21)	1.6 (.063)
**7D241K	4.7 (.185)	5.5 (.216)	1.8 (.07)
**7D271K	4.8 (.19)	5.5 (.216)	2.0 (.08)
**7D301K	4.9 (.19)	5.6 (.22)	2.3 (.09)
**7D331K	5.0 (.196)	5.7 (.22)	2.4 (.094)
**7D361K	5.1 (.2)	5.7 (.22)	2.5 (.1)
**7D391K	5.2 (.2)	5.9 (.23)	2.7 (.1)
**7D431K	5.3 (.21)	6.1 (.24)	2.9 (.11)
**7D471K	6.0 (.236)	7.2 (.28)	3.6 (.14)
7D511K	6.4 (.25)	7.6 (.3)	*3.1 (.12)
7D561K	5.6 (.22)	6.8 (.267)	*3.3 (.13)
7D621K	5.7 (.22)	6.9 (.27)	*3.9 (.15)
7D681K	5.9 (.23)	7.1 (.28)	*4.3 (.17)

\* Bulk parts for 320VAC and larger come standard with inline crimp (as referenced at beginning of “Standard Dimensions and Lead Modification Options” section ) for straight disk seating on PC boards. Therefore, “a” dimension is not applicable. If 320VAC and larger size are required without in-line crimp, please reference “Part Number System” position # (8) and add “N” and reference “a” dimensions (for off-set) above.

\*\* These dimensions also apply to “E” Series (High Energy) parts. For suffix “V” (Extremely High Energy Type) add 0.1 (0.004) to “E Max.”



## Standard Dimensions and Lead Modification Options (continued)

### E Max Dimensions (For Phenolic Coating)

Dimensions are in mm (inches)

#### 10D Series



Style	E Max mm (in)		Off-set Dimension (a) ±1 (±0.04) mm (in)
	B	P	
10D180K	4.3 (.17)	5.5 (.216)	1.4 (.055)
10D220K	4.5 (.177)	5.7 (.22)	1.5 (.06)
10D270K	4.7 (.185)	5.9 (.23)	1.6 (.063)
10D330K	4.8 (.19)	6.0 (.236)	1.8 (.07)
10D390K	4.9 (.19)	6.1 (.24)	1.6 (.063)
10D470K	4.8 (.19)	6.1 (.24)	1.7 (.067)
10D560K	4.9 (.19)	6.1 (.24)	1.8 (.07)
10D680K	5.1 (.2)	6.5 (.256)	2.1 (.083)
**10D820K	4.4 (.17)	5.8 (.23)	1.4 (.055)
**10D101K	4.3 (.17)	5.7 (.22)	1.4 (.055)
**10D121K	4.4 (.17)	5.8 (.23)	1.5 (.06)
**10D151K	4.5 (.177)	5.9 (.23)	1.5 (.06)
**10D181K	4.7 (.185)	6.1 (.24)	1.6 (.063)
**10D201K	4.7 (.185)	6.1 (.24)	1.8 (.07)
**10D221K	4.8 (.19)	5.8 (.23)	1.8 (.07)
**10D241K	5.0 (.196)	5.9 (.23)	2.0 (.08)
**10D271K	5.1 (.2)	6.0 (.236)	2.2 (.087)

Style	E Max mm (in)		Off-set Dimension (a) ±1 (±0.04) mm (in)
	B	P	
**10D301K	5.2 (.2)	6.1 (.24)	2.5 (.1)
**10D331K	5.3 (.21)	6.3 (.25)	2.5 (.1)
**10D361K	5.4 (.21)	6.4 (.25)	2.7 (.1)
**10D391K	5.5 (.216)	6.5 (.256)	2.9 (.11)
**10D431K	5.6 (.22)	6.7 (.26)	3.1 (.12)
**10D471K	5.6 (.22)	6.8 (.267)	3.6 (.14)
**10D511K	5.9 (.23)	7.1 (.28)	*3.4 (.13)
**10D561K	6.0 (.236)	7.2 (.28)	*3.5 (.138)
**10D621K	6.3 (.25)	7.5 (.295)	*4.2 (.165)
**10D681K	6.6 (.26)	7.8 (.307)	*4.6 (.18)
**10D751K	6.8 (.267)	8.0 (.315)	*5.0 (.197)
**10D781K	7.1 (.28)	8.1 (.32)	*5.0 (.197)
**10D821K	7.4 (.29)	8.4 (.33)	*5.4 (.2)
10D911K	7.8 (.307)	8.8 (.346)	*5.9 (.23)
10D102K	8.2 (.32)	9.2 (.36)	*6.4 (.25)
10D112K	8.5 (.335)	9.5 (.37)	*7.0 (.275)

#### 14D Series

Style	E Max mm (in)		Off-set Dimension (a) ±1 (±0.04) mm (in)
	B	P	
14D180K	4.4 (.17)	5.6 (.22)	1.4 (.055)
14D220K	4.6 (.18)	5.8 (.23)	1.5 (.06)
14D270K	4.8 (.19)	6.0 (.236)	1.7 (.067)
14D330K	5.0 (.196)	6.2 (.24)	1.9 (.075)
14D390K	4.7 (.185)	5.9 (.23)	1.7 (.067)
14D470K	4.8 (.19)	6.2 (.24)	1.8 (.07)
14D560K	5.0 (.196)	6.2 (.24)	2.0 (.08)
14D680K	5.2 (.2)	6.6 (.26)	2.2 (.087)
**14D820K	4.4 (.17)	5.8 (.23)	1.4 (.055)
**14D101K	4.4 (.17)	5.8 (.23)	1.5 (.06)
**14D121K	4.5 (.177)	5.9 (.23)	1.5 (.06)
**14D151K	4.5 (.177)	5.9 (.23)	1.5 (.06)
**14D181K	4.7 (.185)	6.1 (.24)	1.7 (.067)
**14D201K	4.7 (.185)	6.1 (.24)	1.9 (.075)
**14D221K	4.8 (.19)	5.8 (.23)	1.9 (.075)
**14D241K	5.0 (.196)	5.9 (.23)	2.1 (.083)
**14D271K	5.1 (.2)	6.0 (.236)	2.2 (.087)

Style	E Max mm (in)		Off-set Dimension (a) ±1 (±0.04) mm (in)
	B	P	
**14D301K	5.2 (.2)	6.1 (.24)	2.6 (.1)
**14D331K	5.3 (.21)	6.3 (.25)	2.6 (.1)
**14D361K	5.4 (.21)	6.4 (.25)	2.8 (.11)
**14D391K	5.5 (.216)	6.5 (.256)	3.0 (.12)
**14D431K	5.6 (.22)	6.7 (.26)	3.2 (.126)
**14D471K	5.7 (.22)	6.9 (.27)	3.8 (.15)
**14D511K	5.9 (.23)	7.1 (.28)	*3.4 (.13)
**14D561K	6.2 (.24)	7.4 (.29)	*3.5 (.138)
**14D621K	6.4 (.25)	7.6 (.3)	*4.2 (.165)
**14D681K	6.6 (.26)	7.8 (.307)	*4.7 (.185)
**14D751K	6.9 (.27)	8.1 (.32)	*5.1 (.2)
**14D781K	7.3 (.287)	8.2 (.32)	*5.1 (.2)
**14D821K	7.5 (.3)	8.5 (.335)	*5.5 (.22)
14D911K	7.9 (.31)	8.9 (.35)	*6.0 (.24)
14D102K	8.2 (.32)	9.2 (.36)	*6.5 (.255)
14D112K	8.7 (.34)	9.7 (.38)	*7.2 (.28)

\* Bulk parts for 320VAC and larger come standard with inline crimp (as referenced at beginning of “Standard Dimensions and Lead Modification Options” section ) for straight disk seating on PC boards. Therefore, “a” dimension is not applicable. If 320VAC and larger size are required without in-line crimp, please reference “Part Number System” position # (8) and add “N” and reference “a” dimensions (for off-set) above.

\*\* These dimensions also apply to “E” Series (High Energy) parts. For suffix “V” (Extremely High Energy Type) add 0.1 (0.004) to “E Max.”

## Standard Dimensions and Lead Modification Options (continued)

### E Max Dimensions (For Phenolic Coating)

Dimensions are in mm (inches)

#### 20D Series



Style	E Max mm (in)		Off-set Dimension (a) ±1 (±0.04) mm (in)
	B	P	
20D180K	4.8 (.19)	6.0 (.236)	1.5 (.06)
20D220K	5.1 (.2)	6.2 (.24)	1.6 (.063)
20D270K	5.2 (.2)	6.4 (.25)	1.8 (.07)
20D330K	5.4 (.21)	6.6 (.26)	2.1 (.083)
20D390K	5.2 (.2)	6.4 (.25)	2.1 (.083)
20D470K	5.4 (.21)	6.6 (.26)	2.2 (.087)
20D560K	5.6 (.22)	6.8 (.27)	2.2 (.087)
20D680K	5.9 (.23)	7.3 (.287)	2.4 (.094)
**20D820K	4.8 (.19)	6.2 (.24)	1.5 (.06)
**20D101K	4.8 (.19)	6.2 (.24)	1.6 (.063)
**20D121K	4.9 (.19)	6.3 (.25)	1.6 (.063)
**20D151K	5.0 (.196)	6.4 (.25)	1.6 (.063)
**20D181K	5.1 (.2)	6.5 (.256)	1.8 (.07)
**20D201K	5.2 (.2)	6.6 (.26)	2.0 (.08)
**20D221K	5.4 (.21)	6.5 (.256)	2.0 (.08)
**20D241K	5.7 (.22)	6.6 (.26)	2.2 (.087)
**20D271K	5.8 (.23)	6.6 (.26)	2.3 (.09)

Style	E Max mm (in)		Off-set Dimension (a) ±1 (±0.04) mm (in)
	B	P	
**20D301K	5.7 (.22)	6.7 (.28)	2.6 (.1)
**20D331K	5.8 (.23)	6.8 (.27)	2.7 (.1)
**20D361K	5.9 (.23)	6.8 (.27)	2.9 (.11)
**20D391K	6.0 (.236)	7.0 (.275)	3.1 (.12)
**20D431K	6.0 (.236)	7.1 (.28)	3.3 (.13)
**20D471K	6.1 (.24)	7.3 (.287)	4.0 (.157)
**20D511K	6.3 (.25)	7.5 (.3)	*3.4 (.13)
**20D561K	6.6 (.26)	7.8 (.307)	*3.8 (.15)
**20D621K	6.8 (.27)	8.0 (.31)	*4.5 (.18)
**20D681K	7.0 (.275)	8.2 (.32)	*4.8 (.19)
**20D751K	7.3 (.287)	8.5 (.335)	*5.2 (.2)
**20D781K	7.6 (.3)	8.6 (.34)	*5.4 (.2)
**20D821K	7.8 (.31)	8.8 (.346)	*5.6 (.22)
**20D911K	8.2 (.32)	9.2 (.36)	*6.5 (.255)
**20D102K	8.6 (.34)	9.6 (.377)	*6.6 (.26)
**20D112K	9.1 (.36)	10.1 (.397)	*7.3 (.287)

\* Bulk parts for 320VAC and larger come standard with inline crimp (as referenced at beginning of “Standard Dimensions and Lead Modification Options” section ) for straight disk seating on PC boards. Therefore, “a” dimension is not applicable. If 320VAC and larger size are required without in-line crimp, please reference “Part Number System” position # (8) and add “N” and reference “a” dimensions (for off-set) above.

\*\* These dimensions also apply to “E” Series (High Energy) parts. For suffix “V” (Extremely High Energy Type) add 0.1 (0.004) to “E Max.”

## Standard Dimensions and Lead Modification Options (continued)

### E Max Dimensions (For Phenolic Coating)

Dimensions are in mm (inches)

#### 18E High Energy Series

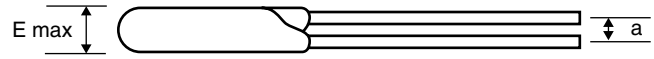

Style	E Max mm (in)		Off-set Dimension (a) ±1 (±0.04) mm (in)
	B	P	
**18E820K	4.5 (.177)	5.9 (.23)	1.5 (.06)
**18E181K	5.0 (.196)	6.4 (.25)	1.9 (.075)
**18E201K	5.0 (.196)	6.4 (.25)	1.9 (.075)
**18E221K	5.3 (.21)	6.4 (.25)	1.9 (.075)
**18E241K	5.5 (.216)	6.4 (.25)	2.0 (.08)
**18E271K	5.6 (.22)	6.4 (.25)	2.2 (.08)
**18E301K	5.7 (.22)	6.6 (.26)	2.3 (.09)
**18E331K	5.7 (.22)	6.6 (.26)	2.7 (.11)
**18E361K	5.7 (.22)	6.6 (.26)	2.8 (.11)
**18E391K	5.8 (.23)	6.9 (.27)	3.0 (.12)
**18E431K	5.9 (.23)	7.0 (.275)	3.2 (.126)

Style	E Max mm (in)		Off-set Dimension (a) ±1 (±0.04) mm (in)
	B	P	
**18E471K	6.0 (.236)	7.2 (.28)	3.9 (.15)
**18E511K	6.2 (.24)	7.4 (.29)	*3.4 (.13)
**18E561K	6.5 (.256)	7.7 (.3)	*3.8 (.15)
**18E621K	6.7 (.26)	7.9 (.31)	*3.2 (.13)
**18E681K	6.9 (.27)	8.1 (.32)	*3.3 (.13)
**18E751K	7.2 (.28)	8.4 (.33)	*3.5 (1.4)
**18E781K	7.5 (.3)	8.5 (.33)	*3.7 (.15)
**18E821K	7.7 (.3)	8.7 (.34)	*5.5 (.22)
**18E911K	8.1 (.32)	9.1 (.36)	*4.1 (.16)
**18E102K	8.5 (.33)	9.5 (.37)	*4.4 (.18)
**18E112K	9.0 (.35)	10 (.39)	*4.8 (.19)

\* Bulk parts for 320VAC and larger come standard with inline crimp (as referenced at beginning of “Standard Dimensions and Lead Modification Options” section ) for straight disk seating on PC boards. Therefore, “a” dimension is not applicable. If 320VAC and larger size are required without in-line crimp, please reference “Part Number System” position # (8) and add “N” and reference “a” dimensions (for off-set) above.

\*\* For suffix “V” (Extremely High Energy Type) add 0.1 (0.004) to “E Max.”

# METAL OXIDE VARISTORS

## D Series – Electrical Characteristics (5, 7, 10, 14, 20, 25 mm)

Part Number	Maximum Continuous Rated Voltage		Rated Single Pulse Transient			Varistor Voltage @1mA DC		Maximum Clamping Voltage @Test Current 8/20µs		Typical Capacitance @1KHZ 25°C
			Energy		Peak					
	AC RMS Volts	DC Volts	2ms Joules	10/1000µs Joules	8/20µs Amps	Min Volts	Max Volts	Volts	Amps	pF
VZ05D180KBS	11	14	0.4	0.6	100	16.2	19.8	36	1	1500
VZ07D180KBS			0.8	1.0	250			36	2.5	2900
VZ10D180KBS			1.7	2.1	500			36	5	6000
VZ14D180KBS			3.5	4.0	1000			36	10	15000
VZ20D180KBS			10	12	2000			36	20	27000
VZ05D220KBS	14	18	0.6	0.8	100	20	24	43	1	1260
VZ07D220KBS			0.9	1.3	250			43	2.5	2400
VZ10D220KBS			2.0	2.5	500			43	5	5000
VZ14D220KBS			4.0	5.0	1000			43	10	12000
VZ20D220KBS			13	15	2000			43	20	20000
VZ05D270KBS	17	22	0.7	0.9	100	24	30	53	1	1050
VZ07D270KBS			1.1	1.4	250			53	2.5	1800
VZ10D270KBS			2.5	3.0	500			53	5	4000
VZ14D270KBS			5.0	6.0	1000			53	10	8500
VZ20D270KBS			15	17	2000			53	20	15000
VZ05D330KBS	20	26	0.9	1.2	100	30	36	65	1	850
VZ07D330KBS			1.3	1.7	250			65	2.5	1500
VZ10D330KBS			3.1	4.0	500			65	5	3500
VZ14D330KBS			6.0	7.5	1000			65	10	7200
VZ20D330KBS			20	22	2000			65	20	12200
VZ05D390KBS	25	31	1.1	1.3	100	35	43	77	1	600
VZ07D390KBS			1.6	2.1	250			77	2.5	1230
VZ10D390KBS			3.7	4.6	500			77	5	3100
VZ14D390KBS			7.0	8.6	1000			77	10	6300
VZ20D390KBS			24	26	2000			77	20	10000
VZ05D470KBS	30	38	1.4	1.6	100	42	52	93	1	500
VZ07D470KBS			2.0	2.5	250			93	2.5	950
VZ10D470KBS			4.5	5.5	500			93	5	2800
VZ14D470KBS			9.0	10	1000			93	10	5500
VZ20D470KBS			30	33	2000			93	20	9350

**D Series – Electrical Characteristics (5, 7, 10, 14, 20, 25 mm) (cont.)**

Part Number	Maximum Continuous Rated Voltage		Rated Single Pulse Transient			Varistor Voltage @1mA DC		Maximum Clamping Voltage @Test Current 8/20µs		Typical Capacitance @1KHZ 25°C
			Energy		Peak			Volts	Amps	pF
	AC RMS Volts	DC Volts	2ms Joules	10/1000µs Joules	8/20µs Amps	Min Volts	Max Volts			
VZ05D560KBS	35	45	1.5	1.9	100	50	62	110	1	400
VZ07D560KBS			2.5	3.1	250			110	2.5	890
VZ10D560KBS			5.5	7.0	500			110	5	2400
VZ14D560KBS			10	11	1000			110	10	4800
VZ20D560KBS			35	38	2000			110	20	8000
VZ05D680KBS	40	56	1.8	2.3	100	61.2	74.8	135	1	360
VZ07D680KBS			3.0	3.8	250			135	2.5	850
VZ10D680KBS			6.5	8.2	500			135	5	2100
VZ14D680KBS			13	14	1000			135	10	4000
VZ20D680KBS			40	43	2000			135	20	6800
VZ05D820KBS	50	66	2.4	3.0	400	74	90	135	5	350
VZ07D820KBS			4.2	5.5	1200			135	10	830
VZ10D820KBS			8.4	12	2500			135	25	1600
VZ14D820KBS			15	22	4500			135	50	3300
VZ20D820KBS			37	48	6500			135	100	5600
VZ05D101KBS	60	85	2.4	3.5	400	90	110	165	5	320
VZ07D101KBS			4.8	6.5	1200			165	10	730
VZ10D101KBS			10	15	2500			165	25	1400
VZ14D101KBS			20	30	4500			165	50	2900
VZ20D101KBS			38	50	6500			165	100	4700
VZ05D121KBS	75	102	3.0	5.0	400	108	132	200	5	250
VZ07D121KBS			5.9	7.8	1200			200	10	570
VZ10D121KBS			12	18	2500			200	25	1200
VZ14D121KBS			22	34	4500			200	50	2600
VZ20D121KBS			40	55	6500			200	100	4100

**D Series – Electrical Characteristics (5, 7, 10, 14, 20, 25 mm) (cont.)**

Part Number	Maximum Continuous Rated Voltage		Rated Single Pulse Transient			Varistor Voltage @1mA DC		Maximum Clamping Voltage @Test Current 8/20µs		Typical Capacitance @1KHZ 25°C
			Energy		Peak					
	AC RMS Volts	DC Volts	2ms Joules	10/1000µs Joules	8/20µs Amps	Min Volts	Max Volts	Volts	Amps	pF
VZ05D151KBS	95	127	3.5	5.5	400	135	165	250	5	180
VZ07D151KBS			7.6	9.7	1200			250	10	400
VZ10D151KBS			16	22	2500			250	25	1100
VZ14D151KBS			30	45	4500			250	50	2000
VZ20D151KBS			50	70	6500			250	100	3200
VZ05D181KBS	120	160	4.2	8.0	400	170	207	320	5	155
VZ07D181KBS			8.8	12	1200			300	10	305
VZ10D181KBS			18.5	27.5	2500			300	25	700
VZ14D181KBS			33	53	4500			300	50	1400
VZ20D181KBS			60	85	10000			300	100	2500
VZ25D181KBS			90	180	18000			300	100	3900
VZ05D201KBS	130	175	5.0	8.5	400	184	224	340	5	140
VZ07D201KBS			10	13	1200			340	10	275
VZ10D201KBS			20	30	2500			300	25	640
VZ14D201KBS			38	60	4500			300	50	1370
VZ20D201KBS			70	95	10000			300	100	2200
VZ25D201KBS			—	200	20000			300	100	3600
VZ05D221KBS	140	180	6.0	9.0	400	198	242	360	5	125
VZ07D221KBS			11	14	1200			360	10	250
VZ10D221KBS			23	32	2500			360	25	600
VZ14D221KBS			40	60	4500			360	50	1150
VZ20D221KBS			75	100	10000			360	100	2000
VZ25D221KBS			—	225	20000			360	100	3300
VZ05D241KBS	150	200	6.5	10	400	216	264	395	5	115
VZ07D241KBS			11	16	1200			395	10	230
VZ10D241KBS			25	35	2500			395	25	560
VZ14D241KBS			45	66	4500			395	50	1060
VZ20D241KBS			82	120	10000			395	100	1900
VZ25D241KBS			—	235	20000			395	100	3000

**D Series – Electrical Characteristics (5, 7, 10, 14, 20, 25 mm) (cont.)**

Part Number	Maximum Continuous Rated Voltage		Rated Single Pulse Transient			Varistor Voltage @1mA DC		Maximum Clamping Voltage @Test Current 8/20µs		Typical Capacitance @1KHZ 25°C
			Energy		Peak			Volts	Amps	
	AC RMS Volts	DC Volts	2ms Joules	10/1000µs Joules	8/20µs Amps	Min Volts	Max Volts			Volts
VZ05D271KBS	180	230	7.5	11	400	255	311	475	5	105
VZ07D271KBS			13	18	1200			455	10	205
VZ10D271KBS			30	40	2500			455	25	500
VZ14D271KBS			52	72	4500			455	50	950
VZ20D271KBS			90	127	10000			455	100	1700
*VZ25D271KBS			—	245	20000			465	100	2600
VZ05D301KBS	195	250	8.0	11.5	400	270	330	525	5	95
VZ07D301KBS			13	19	1200			505	10	185
VZ10D301KBS			32	42.5	2500			505	25	450
VZ14D301KBS			56	78	4500			505	50	890
VZ20D301KBS			100	135	10000			505	100	1540
VZ25D301KBS			—	255	20000			505	100	2400
VZ05D331KBS	210	275	8.5	11.7	400	297	363	540	5	85
VZ07D331KBS			14	20	1200			540	10	170
VZ10D331KBS			33.5	44.5	2500			540	25	415
VZ14D331KBS			63	87	4500			540	50	800
VZ20D331KBS			110	148	10000			540	100	1400
*VZ25D331KBS			—	270	20000			540	100	2200
VZ05D361KBS	230	300	9.0	13	400	324	396	595	5	80
VZ07D361KBS			17	25	1200			595	10	155
VZ10D361KBS			36	47	2500			595	25	380
VZ14D361KBS			70	98	4500			595	50	725
VZ20D361KBS			120	163	10000			595	100	1320
VZ25D361KBS			—	315	20000			595	100	2100
VZ05D391KBS	250	330	10	15	400	351	429	650	5	75
VZ07D391KBS			19	26	1200			650	10	145
VZ10D391KBS			40	60	2500			650	25	350
VZ14D391KBS			72	102	4500			650	50	665
VZ20D391KBS			130	180	10000			650	100	1210
VZ25D391KBS			—	342	20000			650	100	1900

**D Series – Electrical Characteristics (5, 7, 10, 14, 20, 25 mm) (cont.)**

Part Number	Maximum Continuous Rated Voltage		Rated Single Pulse Transient			Varistor Voltage @1mA DC		Maximum Clamping Voltage @Test Current 8/20µs		Typical Capacitance @1KHZ 25°C
			Energy		Peak					
	AC RMS Volts	DC Volts	2ms Joules	10/1000µs Joules	8/20µs Amps	Min Volts	Max Volts	Volts	Amps	pF
VZ05D431KBS	275	370	11	16	400	387	473	710	5	65
VZ07D431KBS			21	28	1200			710	10	130
VZ10D431KBS			45	65	2500			710	25	310
VZ14D431KBS			75	115	4500			710	50	600
VZ20D431KBS			140	190	10000			710	100	1120
VZ25D431KBS			—	370	20000			710	100	1700
VZ05D471KBS	300	385	13	19	400	423	517	775	5	55
VZ07D471KBS			23	30	1200			775	10	115
VZ10D471KBS			47	70	2500			775	25	280
VZ14D471KBS			80	125	4500			775	50	570
VZ20D471KBS			150	220	10000			775	100	1000
VZ25D471KBS			—	390	20000			775	100	1600
VZ05D511KBS	320	420	15	21	400	459	561	865	5	39
VZ07D511KBS			23	32	1200			850	10	82
VZ10D511KBS			50	71	2500			840	25	260
VZ14D511KBS			84	128	4500			840	50	530
VZ20D511KBS			152	222	10000			840	100	950
VZ25D511KBS			—	422	20000			840	100	1500
VZ05D561KBS	360	470	17	25	400	522	638	960	5	36
VZ07D561KBS			27	39	1200			960	10	75
VZ10D561KBS			48	72	2500			910	25	240
VZ14D561KBS			85	139	4500			950	50	480
VZ20D561KBS			154	226	10000			910	100	900
VZ25D561KBS			—	460	20000			910	100	1300
VZ05D621KBS	390	505	19	27	400	558	682	1040	5	33
VZ07D621KBS			29	43	1200			1040	10	68
VZ10D621KBS			49	73	2500			1025	25	150
VZ14D621KBS			88	142	4500			1025	50	270
VZ20D621KBS			158	228	10000			1025	100	770
VZ25D621KBS			—	495	20000			1025	100	1200



**D Series – Electrical Characteristics (5, 7, 10, 14, 20, 25 mm) (cont.)**

Part Number	Maximum Continuous Rated Voltage		Rated Single Pulse Transient			Varistor Voltage @1mA DC		Maximum Clamping Voltage @Test Current 8/20µs		Typical Capacitance @1KHZ 25°C
			Energy		Peak			Volts	Amps	pF
	AC RMS Volts	DC Volts	2ms Joules	10/1000µs Joules	8/20µs Amps	Min Volts	Max Volts			
VZ05D681KBS	420	560	21	30	400	612	748	1120	5	30
VZ07D681KBS			32	45	1200			1120	10	62
VZ10D681KBS			50	74	2500			1120	25	130
VZ14D681KBS			90	142	4500			1120	50	240
VZ20D681KBS			160	230	10000			1120	100	700
VZ25D681KBS			—	515	20000			1120	100	1100
VZ10D751KBS	460	615	51	75	2500	675	825	1240	25	120
VZ14D751KBS			100	143	4500			1240	50	210
VZ20D751KBS			175	255	10000			1240	100	640
VZ25D751KBS			—	530	20000			1240	100	1000
VZ10D781KBS	485	640	52	80	2500	702	858	1290	25	120
VZ14D781KBS			105	148	4500			1240	50	205
VZ20D781KBS			180	265	10000			1240	100	590
VZ25D781KBS			—	540	20000			1240	100	990
VZ10D821KBS	510	675	55	85	2500	738	902	1350	25	110
VZ14D821KBS			110	157	4500			1350	50	200
VZ20D821KBS			195	282	10000			1350	100	510
VZ25D821KBS			—	550	20000			1350	100	920
VZ10D911KBS	550	745	60	93	2500	819	1001	1400	25	90
VZ14D911KBS			120	175	4500			1400	50	175
VZ20D911KBS			215	310	10000			1400	100	430
VZ25D911KBS			—	600	20000			1400	100	860
VZ10D102KBS	625	825	68	102	2500	900	1100	1650	25	80
VZ14D102KBS			130	190	4500			1620	50	145
VZ20D102KBS			230	342	10000			1620	100	380
VZ25D102KBS			—	630	20000			1620	100	760
VZ10D112KBS	680	895	72	115	2500	957.6	1170.4	1815	25	70
VZ14D112KBS			140	215	4500			1800	50	140
VZ20D112KBS			250	383	10000			1800	100	340
VZ25D112KBS			—	700	20000			1800	100	690

**High Energy E Series – Electrical Characteristics (5, 7, 10, 14, 18, 20 mm)**

Part Number	Maximum Continuous Rated Voltage		Rated Single Pulse Transient		Varistor Voltage @1mA DC		Maximum Clamping Voltage @Test Current 8/20µs		Typical Capacitance @1KHZ 25°C
			Energy	Peak			Volts	Amps	pF
	AC RMS Volts	DC Volts	10/1000µs Joules	8/20µs Amps	Min Volts	Max Volts			
VZ05E820KBS	50	66	3.5	800	74	90	135	5	355
VZ07E820KBS			7	1750				10	790
VZ10E820KBS			14	3500				25	1780
VZ14E820KBS			28	6000				50	3310
VZ18E820KBS			46	8000				80	4300
VZ20E820KBS			56	10000				100	5300
VZ05E181KBS	120	160	8	800	170	207	310	5	130
VZ07E181KBS			16	1750			320	10	210
VZ10E181KBS			33	3500			320	25	460
VZ14E181KBS			56	6000			320	50	800
VZ18E181KBS			70	9000			320	80	1300
VZ20E181KBS			135	12000			320	100	1800
VZ05E201KBS	130	175	8.5	800	185	225	340	5	120
VZ07E201KBS			17.5	1750			330	10	200
VZ10E201KBS			42	3500			330	25	430
VZ14E201KBS			78	6000			330	50	770
VZ18E201KBS			140	9000			340	80	1270
VZ18E201KBS-V			160	12000			340	80	2000
VZ20E201KBS			170	12000			340	100	1700
VZ20E201KBS-V			195	15000			340	100	2200
VZ05E221KBS	140	180	9	800	198	242	360	5	110
VZ07E221KBS			19	1750				10	190
VZ10E221KBS			43	3500				25	410
VZ14E221KBS			85	6000				50	740
VZ18E221KBS			150	9000				80	1220
VZ18E221KBS-V			180	12000				80	1700
VZ20E221KBS			180	12000				100	1600
VZ20E221KBS-V			220	15000				100	2100

**High Energy E Series – Electrical Characteristics (5, 7, 10, 14, 18, 20 mm) (cont.)**

Part Number	Maximum Continuous Rated Voltage		Rated Single Pulse Transient		Varistor Voltage @1mA DC		Maximum Clamping Voltage @Test Current 8/20µs		Typical Capacitance @1KHZ 25°C
			Energy	Peak			Volts	Amps	
	AC RMS Volts	DC Volts	10/1000µs Joules	8/20µs Amps	Min Volts	Max Volts			pF
VZ05E241KBS	150	200	10.5	800	216	264	395	5	100
VZ07E241KBS			21	1750				10	170
VZ10E241KBS			45	3500				25	380
VZ14E241KBS			90	6000				50	700
VZ18E241KBS			155	9000				80	1200
VZ18E241KBS-V			195	12000				80	1500
VZ20E241KBS			190	12000				100	1500
VZ20E241KBS-V			240	15000				100	2000
VZ05E271KBS	180	230	11	800	255	311	475	5	90
VZ07E271KBS			24	1750			450	10	150
VZ10E271KBS			49	3500			450	25	350
VZ14E271KBS			99	6000			450	50	640
VZ18E271KBS			163	9000			455	80	1050
VZ20E271KBS			200	12000			455	100	1300
VZ18E301KBS	195	250	170	9000	270	330	505	80	1010
VZ20E301KBS			210	12000			505	100	1200
VZ05E331KBS	210	275	13	800	297	363	540	5	75
VZ07E331KBS			28	1750			540	10	130
VZ10E331KBS			58	3500			540	25	300
VZ14E331KBS			115	6000			545	50	580
VZ18E331KBS			190	9000			545	80	950
VZ20E331KBS			228	12000			545	100	1100
VZ05E361KBS	230	300	16	800	324	396	595	5	69
VZ07E361KBS			32	1750				10	123
VZ10E361KBS			65	3500				25	285
VZ14E361KBS			140	6000				50	540
VZ18E361KBS			220	9000				80	870
VZ20E361KBS			275	12000				100	1050

**High Energy E Series – Electrical Characteristics (5, 7, 10, 14, 18, 20 mm) (cont.)**

Part Number	Maximum Continuous Rated Voltage		Rated Single Pulse Transient		Varistor Voltage @1mA DC		Maximum Clamping Voltage @Test Current 8/20µs		Typical Capacitance @1KHZ 25°C
			Energy	Peak			Volts	Amps	pF
	AC RMS Volts	DC Volts	10/1000µs Joules	8/20µs Amps	Min Volts	Max Volts			
VZ05E391KBS	250	330	17	800	351	429	675	5	63
VZ07E391KBS			35	1750			650	10	116
VZ10E391KBS			70	3500			650	25	270
VZ14E391KBS			150	6000			650	50	500
VZ18E391KBS			245	9000			650	80	800
VZ20E391KBS			305	12000			650	100	1000
VZ05E431KBS	275	370	20	800	387	473	740	5	57
VZ07E431KBS			40	1750			710	10	108
VZ10E431KBS			80	3500			710	25	255
VZ14E431KBS			165	6000			710	50	460
VZ18E431KBS			270	9000			710	80	730
VZ20E431KBS			330	12000			710	100	950
VZ05E471KBS	300	385	21	800	423	517	775	5	50
VZ07E471KBS			42	1750				10	100
VZ10E471KBS			85	3500				25	230
VZ14E471KBS			175	6000				50	400
VZ18E471KBS			290	9000				80	660
VZ20E471KBS			350	12000				100	900
VZ10E511KBS	320	420	92	3500	459	561	840	25	210
VZ14E511KBS			190	6000				50	350
VZ18E511KBS			314	9000				80	570
VZ18E511KBS-V			350	12000				80	570
VZ20E511KBS			382	12000				100	800
VZ20E511KBS-V			400	15000				100	800

**High Energy E Series – Electrical Characteristics (5, 7, 10, 14, 18, 20 mm) (cont.)**

Part Number	Maximum Continuous Rated Voltage		Rated Single Pulse Transient		Varistor Voltage @1mA DC		Maximum Clamping Voltage @Test Current 8/20µs		Typical Capacitance @1KHZ 25°C
			Energy	Peak			Volts	Amps	pF
	AC RMS Volts	DC Volts	10/1000µs Joules	8/20µs Amps	Min Volts	Max Volts			
VZ10E561KBS	360	470	97	3500	522	638	910	25	170
VZ14E561KBS			210	6000				50	320
VZ18E561KBS			330	9000				80	560
VZ20E561KBS			420	12000				100	720
VZ18E621KBS	390	505	330	9000	558	682	1025	80	470
VZ20E621KBS			430	12000				100	710
VZ18E681KBS	420	560	340	9000	612	748	1120	80	430
VZ20E681KBS			435	12000				100	680
VZ18E751KBS	460	615	360	9000	675	825	1240	80	390
VZ20E751KBS			440	12000				100	620
VZ18E781KBS	485	640	365	9000	702	858	1290	80	370
VZ20E781KBS			450	12000			1240	100	560
VZ10E821KBS	510	675	110	3500	738	902	1350	25	110
VZ14E821KBS			235	6000				50	190
VZ18E821KBS			388	9000				80	310
VZ20E821KBS			460	12000				100	530

**VZ25R Series – Electrical Characteristics**

Part Number	Continuous Rated Voltage		Rated Single Pulse Transient		Varistor Voltage @1mA DC		Maximum Clamping Voltage @Test Current 8/20µs		Typical Capacitance @1KHZ 25°C
			Energy	Peak			Volts	Amps	
	AC RMS Volts	DC Volts	10/1000µs Joules	8/20µs KAmps	Min Volts	Max Volts			pF
VZ25R181KBS	120	160	225	22	170	207	300	100	4900
VZ25R201KBS	130	175	250	22	184	226	340	100	4500
VZ25R221KBS	140	180	281	22	200	240	360	100	4150
VZ25R241KBS	150	200	294	22	220	268	395	100	3810
VZ25R271KBS	180	225	306	22	243	297	475	100	3250
VZ25R301KBS	195	250	319	22	270	330	505	100	3000
VZ25R331KBS	210	275	338	22	297	363	540	100	2750
VZ25R361KBS	230	300	394	22	324	396	595	100	2560
VZ25R391KBS	250	330	428	22	351	429	650	100	2380
VZ25R431KBS	275	370	463	22	387	473	710	100	2130
VZ25R471KBS	300	385	488	22	423	517	775	100	2000
VZ25R511KBS	320	420	528	22	459	561	865	100	1750
VZ25R561KBS	360	470	575	22	522	638	960	100	1500
VZ25R621KBS	385	500	619	22	558	682	1040	100	1480
VZ25R681KBS	420	560	644	22	617	754	1120	100	1380
VZ25R751KBS	460	615	663	22	675	825	1240	100	1250
VZ25R781KBS	485	640	675	22	702	858	1290	100	1230
VZ25R821KBS	510	675	688	22	735	902	1350	100	1150
VZ25R911KBS	550	745	750	22	819	1001	1400	100	1100
VZ25R102KBS	625	825	788	22	900	1100	1620	100	950
VZ25R112KBS	680	895	875	22	962	1175	1815	100	820
VZ25R122KBS	750	970	925	22	1080	1320	1980	100	730

**VZ32KW (Wire Lead) Series – Electrical Characteristics**

Part Number	Continuous Rated Voltage		Rated Single Pulse Transient		Varistor Voltage @1mA DC		Maximum Clamping Voltage @Test Current 8/20µs		Typical Capacitance @1KHZ 25°C
			Energy	Peak			Volts	Amps	
	AC RMS Volts	DC Volts	10/1000µs Joules	8/20µs KAmps	Min Volts	Max Volts			pF
VZ32D201KW	130	175	210	25	184	224	340	200	4700
VZ32D221KW	140	180	235	25	198	242	360	200	4300
VZ32D241KW	150	200	240	25	216	264	395	200	4000
VZ32D271KW	180	230	255	25	255	311	455	200	3500
VZ32D331KW	210	275	300	25	297	363	550	200	3000
VZ32D361KW	230	300	325	25	324	396	595	200	2800
VZ32D391KW	250	330	350	25	351	429	650	200	2500
VZ32D431KW	275	370	380	25	387	473	710	200	2200
VZ32D471KW	300	385	400	25	423	517	775	200	2000
VZ32D511KW	320	420	430	25	459	561	840	200	1900
VZ32D561KW	360	470	480	25	522	638	910	200	1700
VZ32D621KW	390	505	500	25	558	682	1025	200	1600
VZ32D681KW	420	560	525	25	612	748	1120	200	1500
VZ32D751KW	460	615	540	25	675	825	1240	200	1400
VZ32D781KW	485	640	550	25	702	858	1290	200	1300
VZ32D821KW	510	675	580	25	738	902	1355	200	1200
VZ32D911KW	550	745	620	25	819	1001	1500	200	1150
VZ32D951KW	575	765	650	25	855	1045	1570	200	1100
VZ32D102KW	625	825	680	25	900	1100	1650	200	1000
VZ32D112KW	680	895	760	25	957.6	1170.4	1815	200	900
VZ32D122KW	750	970	790	25	1062	1300	1980	200	800
VZ32D152KW	880	1150	850	25	1350	1650	2640	200	680

**VZ32 Series – Electrical Characteristics**

Part Number	Continuous Rated Voltage		Rated Single Pulse Transient		Varistor Voltage @1mA DC		Maximum Clamping Voltage @Test Current 8/20µs		Typical Capacitance @1KHZ 25°C
			Energy	Peak			Volts	Amps	
	AC RMS Volts	DC Volts	10/1000µs Joules	8/20µs KAmps	Min Volts	Max Volts	Volts	Amps	pF
VZ32D201 □□□	130	175	210	30	185	225	340	200	4700
VZ32D221 □□□	140	180	240	30	198	242	360	200	4300
VZ32D241 □□□	150	200	250	30	216	264	395	200	4000
VZ32D271 □□□	180	230	260	30	255	311	455	200	3500
VZ32D331 □□□	210	275	310	30	297	363	550	200	3000
VZ32D361 □□□	230	300	330	30	324	396	595	200	2800
VZ32D391 □□□	250	330	360	30	351	429	650	200	2500
VZ32D431 □□□	275	370	400	30	387	473	710	200	2200
VZ32D471 □□□	300	385	405	30	423	517	775	200	2000
VZ32D511 □□□	320	420	440	30	459	561	840	200	1900
VZ32D561 □□□	360	470	500	30	522	638	910	200	1700
VZ32D621 □□□	390	505	550	30	558	682	1025	200	1600
VZ32D681 □□□	420	560	600	30	612	748	1120	200	1500
VZ32D751 □□□	460	615	600	30	675	825	1240	200	1400
VZ32D781 □□□	485	640	600	30	702	858	1290	200	1300
VZ32D821 □□□	510	675	600	30	738	902	1355	200	1200
VZ32D911 □□□	550	745	630	30	819	1001	1500	200	1150
VZ32D951 □□□	575	765	660	30	855	1045	1570	200	1100
VZ32D102 □□□	625	825	690	30	900	1100	1650	200	1000
VZ32D112 □□□	680	895	770	30	957.6	1170.4	1815	200	900
VZ32D122 □□□	750	970	810	30	1062	1300	1980	200	800
VZ32D152 □□□	880	1150	860	30	1350	1650	2640	200	680

□□□ Part Number Suffix Code  
(ie: VZ32D201KR)

- K - Straight Lead
- KL - Straight Lead - Left Side Lead Orientation
- KQ - 90° Bend Lead
- KR - Uncoated Disk - Without Leads
- KF - Uncoated Disk - With Leads
- KN - Uncoated Disk - With one Lead only, Right side orientation
- KNL - Uncoated Disk - With one Lead only, Left side orientation



**VZ32 Series – Dimensions**

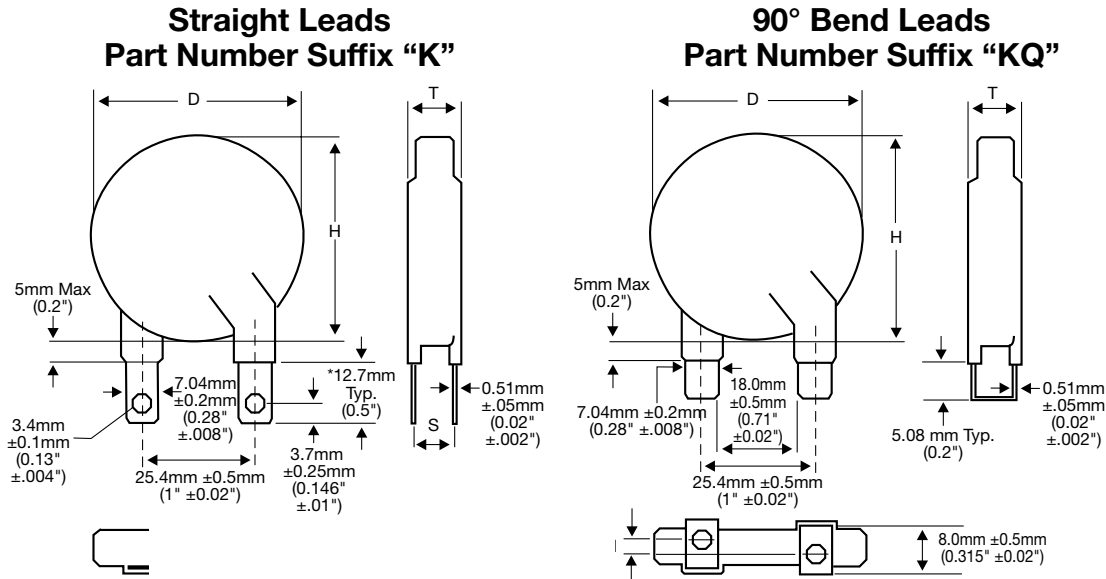

**Uncoated Disk  
Part Number Suffix "KR"**

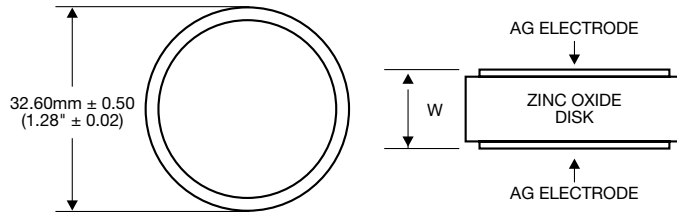

**Note:** All drawings with leads are right side oriented.

Part Number	D max.	H max.	T max.	S ± .7mm (±.03")	d	W
VZ32D201 □□□	40 (1.57)	40 (1.57)	7.5 (.30)	2.5 (.09)	5.7±1.0 (.22±.04)	1.09±0.50 (.04±.02)
VZ32D221 □□□			7.5 (.30)	2.5 (.09)	5.5±1.0 (.22±.04)	1.19±0.50 (.047±.02)
VZ32D241 □□□			7.5 (.30)	2.8 (.11)	5.4±1.0 (.21±.04)	1.32±0.50 (.05±.02)
VZ32D271 □□□			8.5 (.33)	2.8 (.11)	5.2±1.0 (.20±.04)	1.44±0.50 (.056±.02)
VZ32D331 □□□			9.0 (.35)	3.1 (.12)	4.8±1.0 (.19±.04)	1.78±0.50 (.07±.02)
VZ32D361 □□□			9.0 (.35)	3.3 (.13)	4.6±1.0 (.18±.04)	1.97±0.50 (.077±.02)
VZ32D391 □□□			9.0 (.35)	3.6 (.14)	4.4±1.0 (.17±.04)	2.11±0.50 (.083±.02)
VZ32D431 □□□			9.0 (.35)	3.6 (.14)	4.2±1.0 (.165±.04)	2.34±0.50 (.09±.02)
VZ32D471 □□□			9.7 (.38)	3.8 (.15)	4.2±1.0 (.165±.04)	2.53±0.50 (.1±.02)
VZ32D511 □□□			9.7 (.38)	3.8 (.15)	4.0±1.0 (.16±.04)	2.77±0.50 (.11±.02)
VZ32D561 □□□			9.7 (.38)	4.0 (.16)	4.0±1.0 (.16±.04)	3.08±0.5 (.12±.02)
VZ32D621 □□□			9.7 (.38)	4.3 (.17)	3.9±1.0 (.15±.04)	3.40±0.50 (.134±.02)
VZ32D681 □□□			9.7 (.38)	4.6 (.18)	3.6±1.0 (.14±.04)	3.64±0.50 (.143±.02)
VZ32D751 □□□			10.5 (.41)	4.8 (.19)	3.3±1.0 (.13±.04)	4.11±0.50 (.16±.02)
VZ32D781 □□□			10.5 (.41)	4.8 (.19)	3.1±1.0 (.12±.04)	4.15±0.50 (.16±.02)
VZ32D821 □□□			10.5 (.41)	5.1 (.20)	2.9±1.0 (.11±.04)	4.47±0.50 (.176±.02)
VZ32D911 □□□			11.5 (.45)	5.6 (.22)	2.5±1.0 (.10±.04)	4.95±0.50 (.195±.02)
VZ32D951 □□□			11.5 (.45)	5.6 (.22)	2.3±1.0 (.09±.04)	5.05±0.50 (.2±.02)
VZ32D102 □□□			12 (.47)	5.8 (.22)	2.1±1.0 (.08±.04)	5.48±0.50 (.215±.02)
VZ32D112 □□□			12 (.47)	6.4 (.25)	2.1±1.0 (.08±.04)	5.96±0.50 (.23±.02)
VZ32D122 □□□	13 (.51)	8.4 (.33)	1.5±1.0 (.06±.04)	7.2±0.50 (.28±.02)		
VZ32D152 □□□	13 (.51)	10.5 (.41)	0.5±1.0 (.02±.04)	7.2±0.50 (.28±.02)		

## VZ34 Single Series – Electrical Characteristics

Part Number	Continuous Rated Voltage		Rated Single Pulse Transient		Varistor Voltage @1mA DC		Maximum Clamping Voltage @Test Current 8/20µs		Typical Capacitance @1KHZ 25°C
			Energy	Peak			Volts	Amps	
	AC RMS Volts	DC Volts	10/1000µs Joules	8/20µs KAmps 1 time	Min Volts	Max Volts			pF
VZ34R201 □□□	130	175	310	40	185	225	340	300	10000
VZ34R221 □□□	140	180	330	40	198	242	360	300	9000
VZ34R241 □□□	150	200	360	40	216	264	395	300	8000
VZ34R271 □□□	180	230	390	40	255	311	455	300	7100
VZ34R301 □□□	195	250	405	40	270	330	505	300	6000
VZ34R331 □□□	210	275	430	40	297	363	540	300	4800
VZ34R361 □□□	230	300	460	40	324	396	595	300	5600
VZ34R391 □□□	250	330	490	40	351	429	650	300	5000
VZ34R431 □□□	275	370	550	40	387	473	710	300	4500
VZ34R471 □□□	300	385	600	40	423	517	775	300	4000
VZ34R511 □□□	320	420	640	40	459	561	840	300	3800
VZ34R561 □□□	360	470	710	40	522	638	910	300	3700
VZ34R621 □□□	390	505	800	40	558	682	1025	300	3300
VZ34R681 □□□	420	560	910	40	612	748	1120	300	3000
VZ34R751 □□□	460	615	920	40	675	825	1240	300	2600
VZ34R781 □□□	485	640	930	40	702	858	1290	300	2700
VZ34R821 □□□	510	675	940	40	738	902	1355	300	2500
VZ34R911 □□□	550	745	960	40	819	1001	1500	300	1800
VZ34R951 □□□	575	765	1000	40	855	1045	1570	300	1700
VZ34R102 □□□	625	825	1055	40	900	1100	1650	300	1600
VZ34R112 □□□	680	895	1155	40	957.6	1170.4	1815	300	1500
VZ34R122 □□□	750	970	1250	40	1062	1300	1980	300	1300

□□□ - Part Number Suffix Code  
(ie: VZ34R201K)

- K - Straight Lead
- KA - Tab Leads Outward Crimp
- KL - Straight Lead - Left Side Lead Orientation
- KQ - 90° Bend Lead
- KR - Uncoated Disk - Without Leads
- KF - Uncoated Disk - With Leads
- KN - Uncoated Disk - With one Lead only, Right side orientation
- KNL - Uncoated Disk - With one Lead only, Left side orientation

**VZ34 Single Series – Dimensions**

**Straight Leads  
Part Number Suffix “K”**

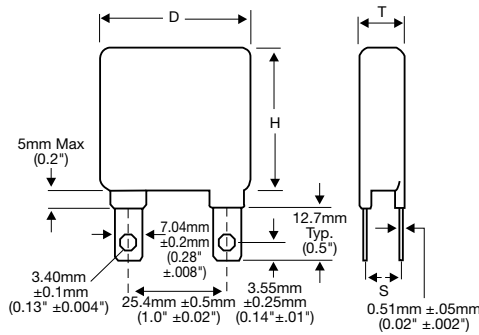

**90° Bend Leads  
Part Number Suffix “KQ”**

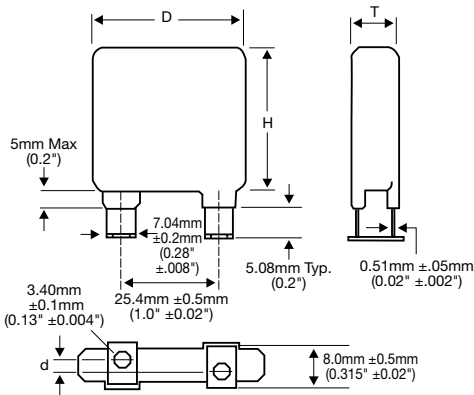

**Tab Leads Outward Crimp  
Part Number Suffix “KA”**

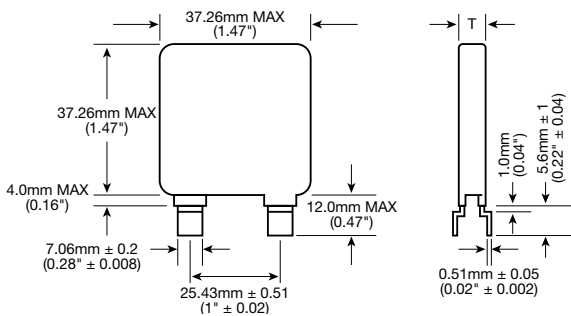

**Uncoated Disk  
Part Number Suffix “KR”**

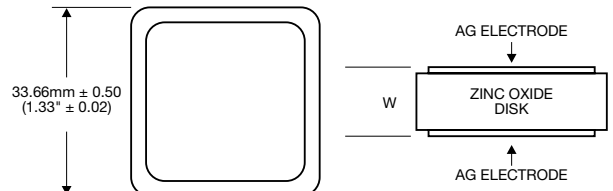

**Note:** All drawings with leads are right side oriented.

Part Number	D max.	H max.	T max.	S ±.7mm (±.03")	d	W
VZ34R201 □□□	42 (1.65)	42 (1.65)	7.5 (.30)	2.5 (.10)	5.7±1.0 (.22±.04)	1.34±0.50 (.05±.02)
VZ34R221 □□□			7.5 (.30)	2.5 (.10)	5.5±1.0 (.22±.04)	1.47±0.50 (.057±.02)
VZ34R241 □□□			7.5 (.30)	2.8 (.11)	5.4±1.0 (.21±.04)	1.62±0.50 (.06±.02)
VZ34R271 □□□			8.5 (.33)	2.8 (.11)	5.2±1.0 (.20±.04)	1.77±0.50 (.07±.02)
VZ34R301 □□□			9.0 (.35)	3.0 (.12)	5.0±1.0 (.20±.04)	2.00±0.50 (.078±.02)
VZ34R331 □□□			9.0 (.35)	3.1 (.12)	4.8±1.0 (.19 ±.04)	2.19±0.50 (.086±.02)
VZ34R361 □□□			9.0 (.35)	3.3 (.13)	4.6±1.0 (.18±.04)	2.42±0.50 (.095±.02)
VZ34R391 □□□			9.0 (.35)	3.6 (.14)	4.4±1.0 (.17±.04)	2.59±0.50 (.1±.02)
VZ34R431 □□□			9.0 (.35)	3.6 (.14)	4.2±1.0 (.17±.04)	2.88±0.50 (.11±.02)
VZ34R471 □□□			9.7 (.38)	3.8 (.15)	4.2±1.0 (.17±.04)	3.1 ±0.50 (.12±.02)
VZ34R511 □□□			9.7 (.38)	3.8 (.15)	4.0±1.0 (.16±.04)	3.41±0.50 (.134±.02)
VZ34R561 □□□			9.7 (.38)	4.0 (.16)	4.0±1.0 (.16±.04)	4.19±0.50 (.165±.02)
VZ34R621 □□□			9.7 (.38)	4.3 (.17)	3.9±1.0 (.15±.04)	4.19±0.50 (.165±.02)
VZ34R681 □□□			9.7 (.38)	4.6 (.18)	3.6±1.0 (.14±.04)	4.49±0.50 (.177±.02)
VZ34R751 □□□			10.5 (.41)	4.8 (.19)	3.3±1.0 (.13±.04)	4.95±0.50 (.195±.02)
VZ34R781 □□□			10.5 (.41)	4.8 (.19)	3.1±1.0 (.12±.04)	5.12±0.50 (.2±.02)
VZ34R821 □□□			10.5 (.41)	5.1 (.20)	2.9±1.0 (.11±.04)	5.50±0.50 (.22±.02)
VZ34R911 □□□			11.5 (.45)	5.6 (.22)	2.5±1.0 (.10±.04)	6.09±0.50 (.24±.02)
VZ34R951 □□□			11.5 (.45)	5.6 (.22)	2.3±1.0 (.09±.04)	6.38±0.50 (.25±.02)
VZ34R102 □□□			12.0 (.47)	5.8 (.23)	2.1±1.0 (.08±.04)	6.75±0.50 (.265±.02)
VZ34R112 □□□	12.0 (.47)	6.4 (.25)	2.1±1.0 (.08±.04)	7.34±0.50 (.29±.02)		
VZ34R122 □□□	12.5 (.49)	6.8 (.27)	1.9±1.0 (.07±.04)	7.5±0.50 (.30±.02)		

**VZ34 Dual Series – Electrical Characteristics**

Part Number	Continuous Rated Voltage*		Rated Single Pulse Transient		Varistor Voltage @1mA DC*		Maximum Clamping Voltage @Test Current 8/20µs		Typical Capacitance @1KHZ 25°C**
			Energy***	Peak***					
	AC RMS Volts	DC Volts	10/1000µs Joules	8/20µs KAmps 1 time	Min Volts	Max Volts	Volts*	Amps	pF
VZ34R201 □□□	130	175	310	40	185	225	340	300	7900
VZ34R221 □□□	140	180	330	40	198	242	360	300	7200
VZ34R241 □□□	150	200	360	40	216	264	395	300	6600
VZ34R271 □□□	180	230	390	40	255	311	455	300	5600
VZ34R301 □□□	195	250	405	40	270	330	505	300	5200
VZ34R331 □□□	210	275	430	40	297	363	540	300	4800
VZ34R361 □□□	230	300	460	40	324	396	595	300	4400
VZ34R391 □□□	250	330	490	40	351	429	650	300	4100
VZ34R431 □□□	275	370	550	40	387	473	710	300	3800
VZ34R471 □□□	300	385	600	40	423	517	775	300	3400
VZ34R511 □□□	320	420	640	40	459	561	840	300	3200
VZ34R561 □□□	360	470	710	40	522	638	910	300	2700
VZ34R621 □□□	390	505	800	40	558	682	1025	300	2600
VZ34R681 □□□	420	560	910	40	612	748	1120	300	2400
VZ34R751 □□□	460	615	920	40	675	825	1240	300	2200
VZ34R781 □□□	485	640	930	40	702	858	1290	300	2100
VZ34R821 □□□	510	675	940	40	738	902	1355	300	2000
VZ34R911 □□□	550	745	960	40	819	1001	1500	300	1800
VZ34R951 □□□	575	765	1000	40	855	1045	1570	300	1700
VZ34R102 □□□	625	825	1055	40	900	1100	1650	300	1600
VZ34R112 □□□	680	895	1155	40	957.6	1170.4	1815	300	1500
VZ34R122 □□□	750	970	1250	40	1062	1300	1980	300	1300

□□□ - Part Number Suffix Code  
(ie: VZ34R201KD)

- KD - Straight Lead
- KDQ - 90° Bend Lead

\* For leads 1-3, double published rating

\*\* For leads 1-3, 50% of published rating

\*\*\* If leads 1-3 are shorted together, then the energy between 2 and (1+3) will be double the rating.

**Termination**

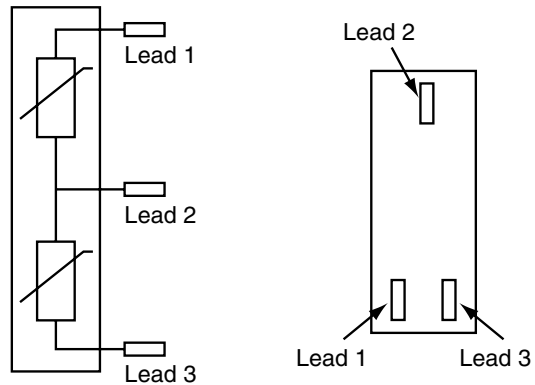

**VZ34 Dual Series – Dimensions**

**Straight Leads  
Part Number Suffix “KD”**

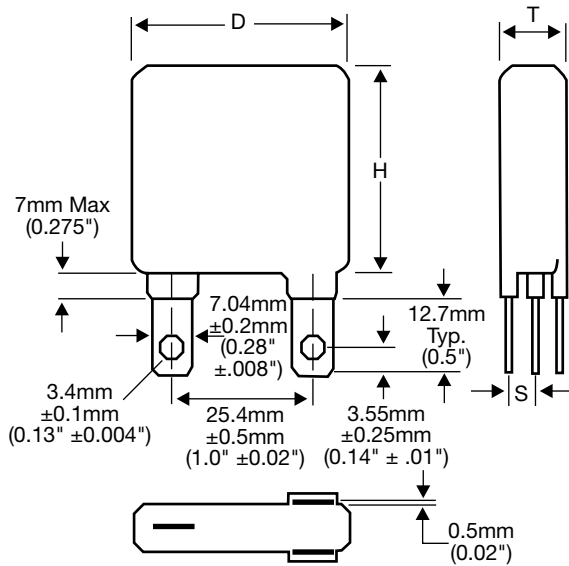

**90° Bend Leads  
Part Number Suffix “KDQ”**

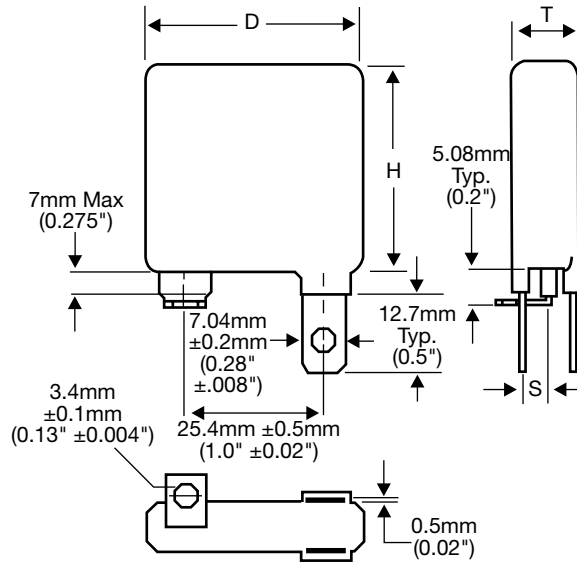

**Note:** All drawings with leads are right side oriented.

Part Number	D max.	H max.	T max.	S ±.7mm (±.03")
VZ34R201 □□□	42 (1.65)	42 (1.65)	9.1 (.36)	4.1 (.16)
VZ34R221 □□□			9.2 (.36)	4.2 (.17)
VZ34R241 □□□			9.3 (.37)	4.6 (.18)
VZ34R271 □□□			9.5 (.37)	4.8 (.19)
VZ34R301 □□□			10.5 (.41)	5.2 (.20)
VZ34R331 □□□			11.3 (.44)	5.4 (.21)
VZ34R361 □□□			11.5 (.45)	5.8 (.23)
VZ34R391 □□□			11.6 (.46)	6.2 (.24)
VZ34R431 □□□			11.9 (.47)	6.5 (.26)
VZ34R471 □□□			12.8 (.50)	6.9 (.27)
VZ34R511 □□□			13.1 (.52)	7.2 (.28)
VZ34R561 □□□			13.4 (.53)	7.7 (.30)
VZ34R621 □□□			13.6 (.54)	8.2 (.32)
VZ34R681 □□□			13.9 (.55)	8.8 (.35)
VZ34R751 □□□			15.3 (.60)	9.3 (.37)
VZ34R781 □□□			15.5 (.61)	9.6 (.38)
VZ34R821 □□□			15.5 (.61)	10.1 (.40)
VZ34R911 □□□			17.0 (.67)	11.1 (.44)
VZ34R951 □□□			17.2 (.68)	11.3 (.44)
VZ34R102 □□□			18.0 (.71)	11.8 (.46)
VZ34R112 □□□	18.6 (.73)	13.0 (.51)		

## VZ40 Series – Electrical Characteristics

Part Number	Continuous Rated Voltage		Rated Single Pulse Transient		Varistor Voltage @1mA DC		Maximum Clamping Voltage @Test Current 8/20µs		Typical Capacitance @1KHZ 25°C
	AC RMS Volts	DC Volts	Energy	Peak	Min Volts	Max Volts	Volts	Amps	pF
			10/1000µs Joules	8/20µs KAmps					
VZ40D201 □□□	130	175	310	40	185	225	340	300	10000
VZ40D221 □□□	140	180	330	40	198	242	360	300	9000
VZ40D241 □□□	150	200	360	40	216	264	395	300	8000
VZ40D271 □□□	180	230	390	40	255	311	455	300	7100
VZ40D301 □□□	195	250	405	40	270	330	505	300	6550
VZ40D331 □□□	210	275	460	40	297	363	550	300	6000
VZ40D361 □□□	230	300	475	40	324	396	595	300	5600
VZ40D391 □□□	250	330	490	40	351	429	650	300	5000
VZ40D431 □□□	275	370	550	40	387	473	710	300	4500
VZ40D471 □□□	300	385	600	40	423	517	775	300	4000
VZ40D511 □□□	320	420	640	40	459	561	840	300	3800
VZ40D561 □□□	360	470	710	40	522	638	910	300	3700
VZ40D621 □□□	390	505	800	40	558	682	1025	300	3300
VZ40D681 □□□	420	560	910	40	612	748	1120	300	3000
VZ40D751 □□□	460	615	910	40	675	825	1240	300	2600
VZ40D781 □□□	485	640	910	40	702	858	1290	300	2500
VZ40D821 □□□	510	675	910	40	738	902	1355	300	2300
VZ40D911 □□□	550	745	960	40	819	1001	1500	300	2200
VZ40D951 □□□	575	765	1000	40	855	1045	1570	300	2000
VZ40D102 □□□	625	825	1055	40	900	1100	1650	300	1900
VZ40D112 □□□	680	895	1155	40	957.6	1170.4	1815	300	1800
VZ40D122 □□□	750	970	1250	40	1062	1300	1980	300	1700
VZ40D152 □□□	900	1200	1400	40	1350	1650	2475	300	1500

□□□ Part Number Suffix Code  
(ie: VZ40D201KR)

- K - Straight Lead
- KL - Straight Lead - Left Side Lead Orientation
- KQ - 90° Bend Lead
- KR - Uncoated Disk - Without Leads
- KF - Uncoated Disk - With Leads
- KN - Uncoated Disk - With one Lead only, Right side orientation
- KNL - Uncoated Disk - With one Lead only, Left side orientation

VZ40 Series – Dimensions

**Straight Leads**  
Part Number Suffix “K”

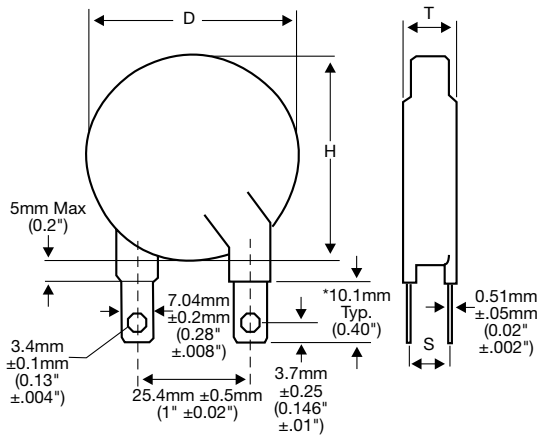

**90° Bend Leads**  
Part Number Suffix “KQ”

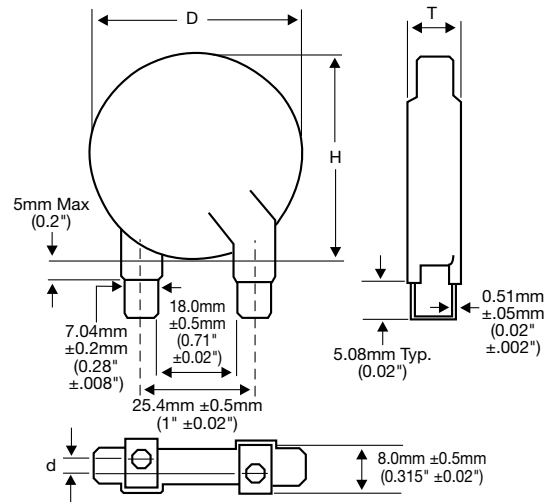

**Uncoated Disk**  
Part Number Suffix “KR”

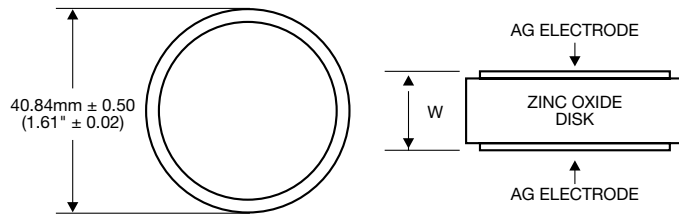

**Note:** All drawings with leads are right side oriented.

Part Number	D max.	H max.	T max.	S ±.7mm (±.03")	d	W
VZ40D201 □□□	48 (1.89)	48 (1.89)	7.5 (.30)	2.5 (.09)	5.7±1.0 (.22±.04)	1.13±0.50 (.044±.02)
VZ40D221 □□□			7.5 (.30)	2.5 (.09)	5.5±1.0 (.22±.04)	1.24±0.50 (.049±.02)
VZ40D241 □□□			7.5 (.30)	2.8 (.11)	5.4±1.0 (.21±.04)	1.38±0.50 (.054±.02)
VZ40D271 □□□			8.5 (.33)	2.8 (.11)	5.2±1.0 (.20±.04)	1.50±0.50 (.06±.02)
VZ40D301 □□□			8.7 (.34)	3.0 (.12)	5.0±1.0 (.20±.04)	1.68±0.50 (.07±.02)
VZ40D331 □□□			9.0 (.35)	3.1 (.12)	4.8±1.0 (.19±.04)	1.86±0.50 (.073±.02)
VZ40D361 □□□			9.0 (.35)	3.3 (.13)	4.6±1.0 (.18±.04)	2.06±0.50 (.08±.02)
VZ40D391 □□□			9.0 (.35)	3.6 (.14)	4.4±1.0 (.17±.04)	2.2±0.50 (.087±.02)
VZ40D431 □□□			9.0 (.35)	3.6 (.14)	4.2±1.0 (.165±.04)	2.44±0.50 (.096±.02)
VZ40D471 □□□			9.7 (.38)	3.8 (.15)	4.2±1.0 (.165±.04)	2.64±0.50 (.104±.02)
VZ40D511 □□□			9.7 (.38)	3.8 (.15)	4.0±1.0 (.16±.04)	2.89±0.50 (.113±.02)
VZ40D561 □□□			9.7 (.38)	4.1 (.16)	4.0±1.0 (.16±.04)	3.21±0.50 (.13±.02)
VZ40D621 □□□			9.7 (.38)	4.3 (.17)	3.9±1.0 (.15±.04)	3.55±0.50 (.14±.02)
VZ40D681 □□□			9.7 (.38)	4.6 (.18)	3.6±1.0 (.14±.04)	3.81±0.50 (.15±.02)
VZ40D751 □□□			10.5 (.41)	4.8 (.19)	3.3±1.0 (.13±.04)	4.19±0.50 (.165±.02)
VZ40D781 □□□			10.5 (.41)	4.8 (.19)	3.1±1.0 (.12±.04)	4.34±0.50 (.17±.02)
VZ40D821 □□□			10.5 (.41)	5.1 (.20)	2.9±1.0 (.11±.04)	4.67±0.50 (.184±.02)
VZ40D911 □□□			11.5 (.45)	5.6 (.22)	2.5±1.0 (.10±.04)	5.1±0.50 (.2±.02)
VZ40D951 □□□			11.5 (.45)	5.6 (.22)	2.3±1.0 (.09±.04)	5.28±0.50 (.21±.02)
VZ40D102 □□□			12.0 (.47)	5.8 (.22)	2.1±1.0 (.08±.04)	5.72±0.50 (.225±.02)
VZ40D112 □□□	12.0 (.47)	6.4 (.25)	2.1±1.0 (.08±.04)	6.22±0.50 (.24±.02)		
VZ40D122 □□□	13.0 (.51)	8.4 (.33)	1.9±1.0 (.07±.04)	7.5±0.50 (.30±.02)		
VZ40D152 □□□	14.5 (.57)	10.2 (.40)	1.0±1.0 (.039±.04)	9.2±0.50 (.36±.02)		

## VZ53 Series – Electrical Characteristics

Part Number	Continuous Rated Voltage		Rated Single Pulse Transient		Varistor Voltage @1mA DC		Maximum Clamping Voltage @Test Current 8/20µs		Typical Capacitance @1KHZ 25°C
	AC RMS Volts	DC Volts	Energy	Peak	Min Volts	Max Volts	Volts	Amps	pF
			10/1000µs Joules	8/20µs KAmps					
VZ53D201 □□□	130	175	490	70	185	225	340	500	18000
VZ53D221 □□□	140	180	530	70	198	242	360	500	16000
VZ53D241 □□□	150	200	570	70	216	264	395	500	14000
VZ53D271 □□□	180	230	630	70	255	311	455	500	12500
VZ53D301 □□□	195	250	655	70	270	330	505	500	12000
VZ53D331 □□□	210	275	680	70	297	363	550	500	11500
VZ53D361 □□□	230	300	730	70	324	396	595	500	10000
VZ53D391 □□□	250	330	880	70	351	429	650	500	8800
VZ53D431 □□□	275	370	950	70	387	473	710	500	8000
VZ53D471 □□□	300	385	1000	70	423	517	775	500	7200
VZ53D511 □□□	320	420	1100	70	459	561	840	500	6600
VZ53D561 □□□	360	430	1200	70	522	638	910	500	6400
VZ53D621 □□□	390	505	1300	70	558	682	1025	500	6200
VZ53D681 □□□	420	560	1500	70	612	748	1120	500	5300
VZ53D751 □□□	460	615	1600	70	675	825	1240	500	5000
VZ53D781 □□□	485	640	1650	70	702	858	1290	500	4800
VZ53D821 □□□	510	675	1800	70	738	902	1355	500	4400
VZ53D911 □□□	550	745	2000	70	819	1001	1500	500	4100
VZ53D951 □□□	575	765	2100	70	855	1045	1570	500	4000
VZ53D102 □□□	625	825	2200	70	900	1100	1650	500	3700
VZ53D112 □□□	680	895	2500	70	957.6	1170.4	1815	500	3300
VZ53D122 □□□	750	970	2700	70	1062	1300	1980	500	3400

□□□ - Part Number Suffix Code  
(ie: VZ53D201KR)

- K - Straight Lead
- KL - Straight Lead - Left Side Lead Orientation
- KQ - 90° Bend Lead
- KR - Uncoated Disk - Without Leads
- KF - Uncoated Disk - With Leads
- KN - Uncoated Disk - With one Lead only, Right side orientation
- KNL - Uncoated Disk - With one Lead only, Left side orientation



**VZ53 Series – Dimensions**

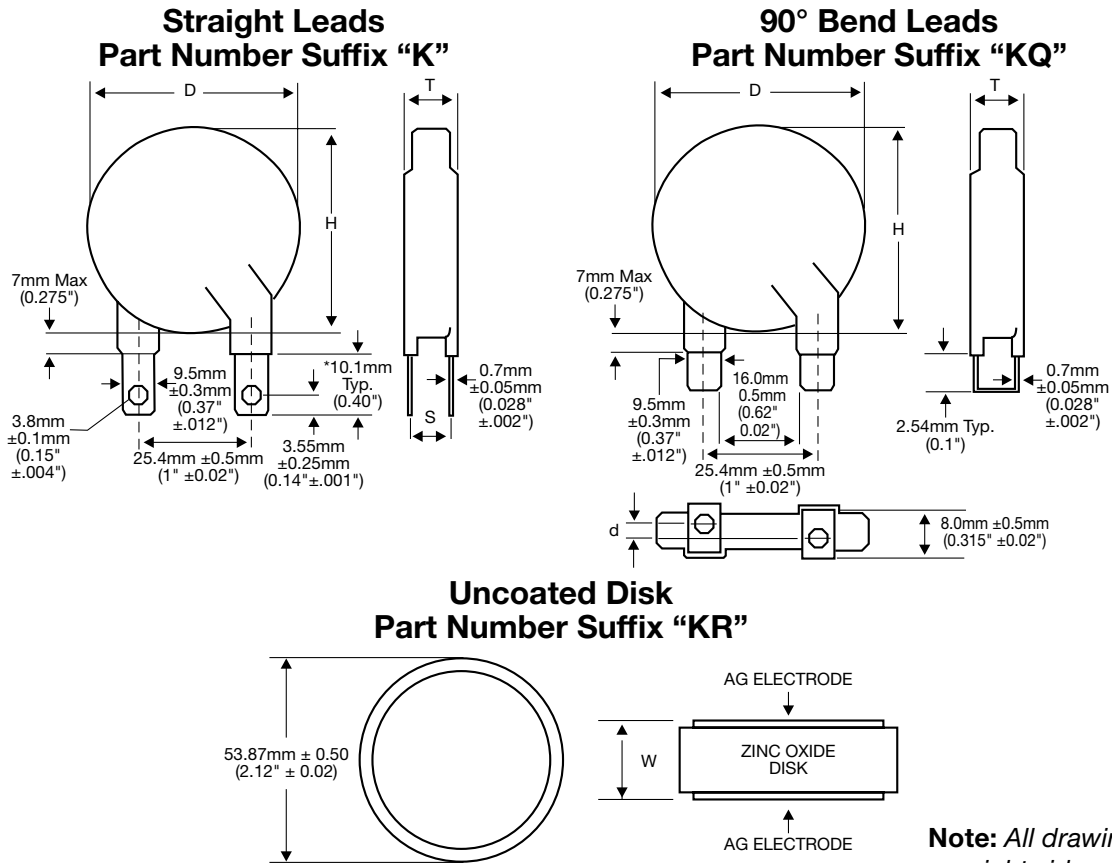

**Note:** All drawings with leads are right side oriented.

PartNumber	D max.	H max.	T max.	S ±.7mm (±.03")	d	W
VZ53D201 □□□	61 (2.4)	61 (2.4)	7.5 (.30)	2.5 (.10)	5.7±1.0 (.22±.04)	1.41±0.50 (.056±.02)
VZ53D221 □□□			7.5 (.30)	2.5 (.10)	5.5±1.0 (.22±.04)	1.55±0.50 (.061±.02)
VZ53D241 □□□			7.5 (.30)	2.8 (.10)	5.4±1.0 (.21±.04)	1.72±0.50 (.068±.02)
VZ53D271 □□□			8.5 (.33)	2.8 (.10)	5.2±1.0 (.20±.04)	1.87±0.50 (.074±.02)
VZ53D301 □□□			8.7 (.34)	3.0 (.12)	5.0±1.0 (.20±.04)	2.10±0.50 (.08±.02)
VZ53D331 □□□			9.0 (.35)	3.1 (.12)	4.8±1.0 (.19±.04)	2.32±0.50 (.091±.02)
VZ53D361 □□□			9.0 (.35)	3.3 (.13)	4.6±1.0 (.18±.04)	2.56±0.50 (.1±.02)
VZ53D391 □□□			9.0 (.35)	3.6 (.14)	4.4±1.0 (.17±.04)	2.74±0.50 (.108±.02)
VZ53D431 □□□			9.0 (.35)	3.6 (.14)	4.2±1.0 (.165±.04)	3.05±0.50 (.12±.02)
VZ53D471 □□□			9.7 (.38)	3.8 (.15)	4.2±1.0 (.165±.04)	3.29±0.50 (.13±.02)
VZ53D511 □□□			9.7 (.38)	3.8 (.15)	4.0±1.0 (.16±.04)	3.60±0.50 (.14±.02)
VZ53D561 □□□			9.7 (.38)	4.3 (.17)	4.0±1.0 (.16±.04)	4.43±0.50 (.174±.02)
VZ53D621 □□□			9.7 (.38)	4.3 (.17)	3.9±1.0 (.15±.04)	4.43±0.50 (.174±.02)
VZ53D681 □□□			9.7 (.38)	4.6 (.18)	3.6±1.0 (.14±.04)	4.74±0.50 (.187±.02)
VZ53D751 □□□			10.5 (.41)	4.6 (.18)	3.3±1.0 (.13±.04)	5.23±0.50 (.206±.02)
VZ53D781 □□□			10.5 (.41)	4.8 (.19)	3.1±1.0 (.12±.04)	5.41±0.50 (.21±.02)
VZ53D821 □□□			10.5 (.41)	5.1 (.20)	2.9±1.0 (.11±.04)	5.82±0.50 (.23±.02)
VZ53D911 □□□			11.5 (.45)	5.6 (.22)	2.5±1.0 (.10±.04)	6.44±0.50 (.25±.02)
VZ53D951 □□□			11.5 (.45)	5.6 (.22)	2.3±1.0 (.09±.04)	6.74±0.50 (.265±.02)
VZ53D102 □□□			11.5 (.45)	5.8 (.23)	2.1±1.0 (.08±.04)	7.13±0.50 (.28±.02)
VZ53D112 □□□	11.5 (.45)	6.4 (.25)	2.1±1.0 (.08±.04)	7.76±0.50 (.306±.02)		
VZ53D122 □□□	12.6 (.50)	7.0 (.28)	1.5±1.0 (.06±.04)	8.49±0.50 (.334±.02)		

## Peak Pulse and Derating Curves

### Peak Current Per Pulse Versus Pulse Duration

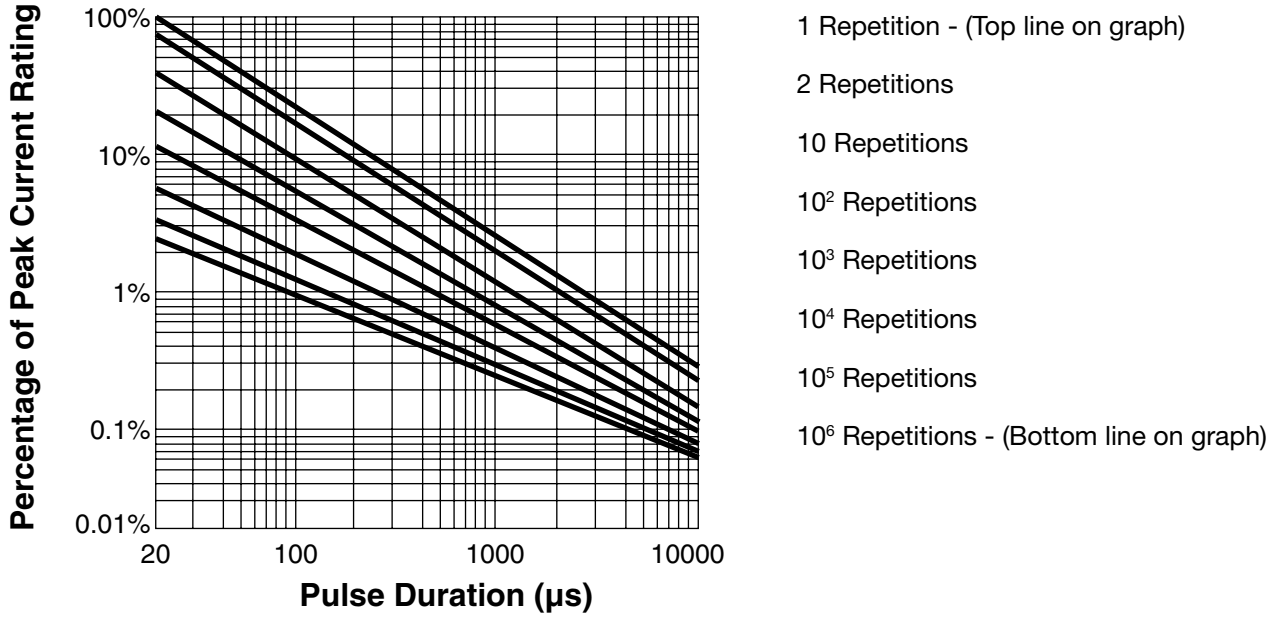

### Temperature Derating Curve Power and Energy Rating vs. Temperature

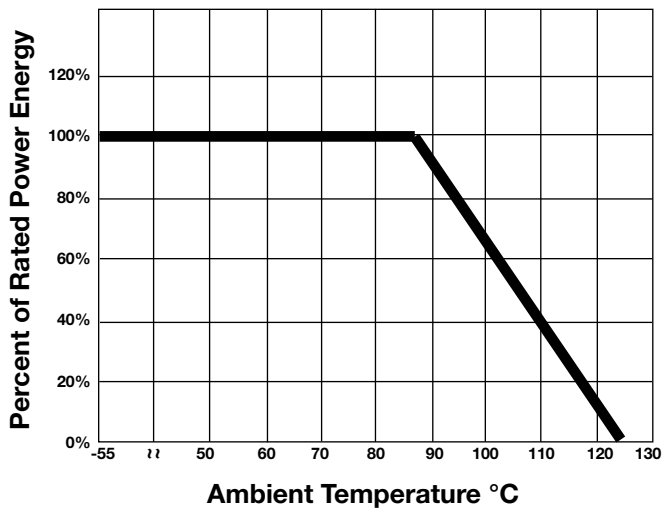

## V-I Characteristics

### 5mm Disk Size

- VZ05D561K - (Top line on graph)
- VZ05D471K
- VZ05D431K
- VZ05D391K
- VZ05D361K
- VZ05D271K
- VZ05D241K
- VZ05D221K
- VZ05D201K
- VZ05D151K
- VZ05D121K
- VZ05D101K
- VZ05D820K - (Bottom line on graph)

(Also applies to "E" series parts)

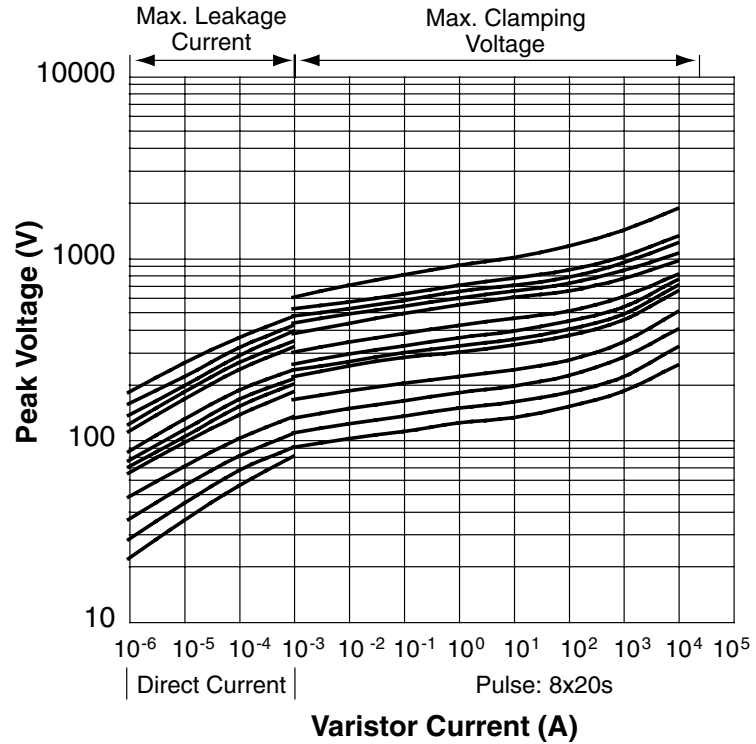

### 7mm Disk Size

- VZ07D681K - (Top line on graph)
- VZ07D621K
- VZ07D561K
- VZ07D511K
- VZ07D471K
- VZ07D391K
- VZ07D331K
- VZ07D271K
- VZ07D241K
- VZ07D201K
- VZ07D181K
- VZ07D151K
- VZ07D121K
- VZ07D101K
- VZ07D820K - (Bottom line on graph)

(Also applies to "E" series parts)

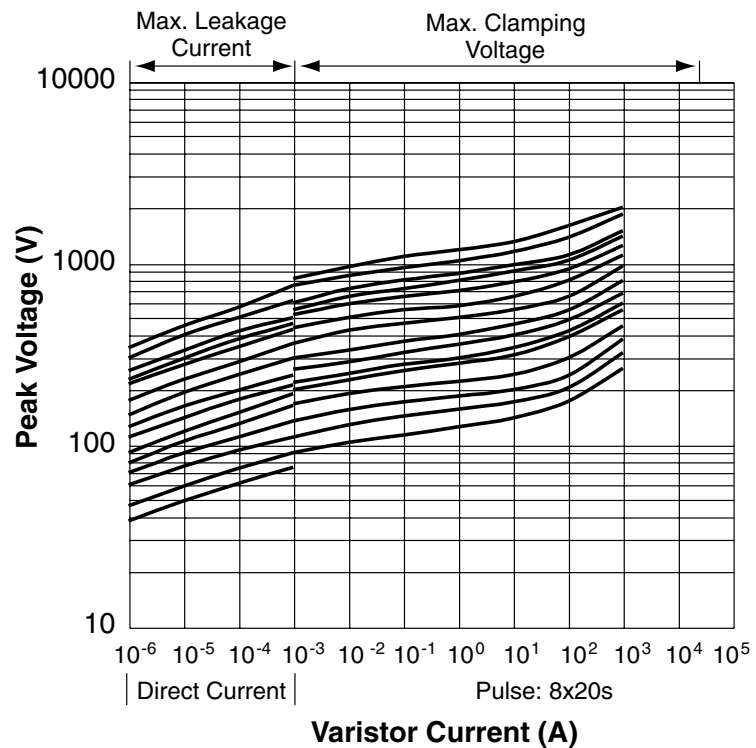

At idle power, current levels shown to the left of the diskontinuity illustrate typically the high end leakage current. However, if lower leakage current levels are desired, they may be guaranteed. In the clamping voltage region to the right of the diskontinuity, maximum clamping voltage is plotted.

**V-I Characteristics (continued)**

**10mm Disk Size**

- VZ10D112K - (Top line on graph)
- VZ10D102K
- VZ10D911K
- VZ10D751K
- VZ10D681K
- VZ10D621K
- VZ10D471K
- VZ10D391K
- VZ10D271K
- VZ10D241K
- VZ10D221K
- VZ10D201K
- VZ10D151K
- VZ10D121K
- VZ10D101K
- VZ10D820K - (Bottom line on graph)

(Also applies to "E" series parts)

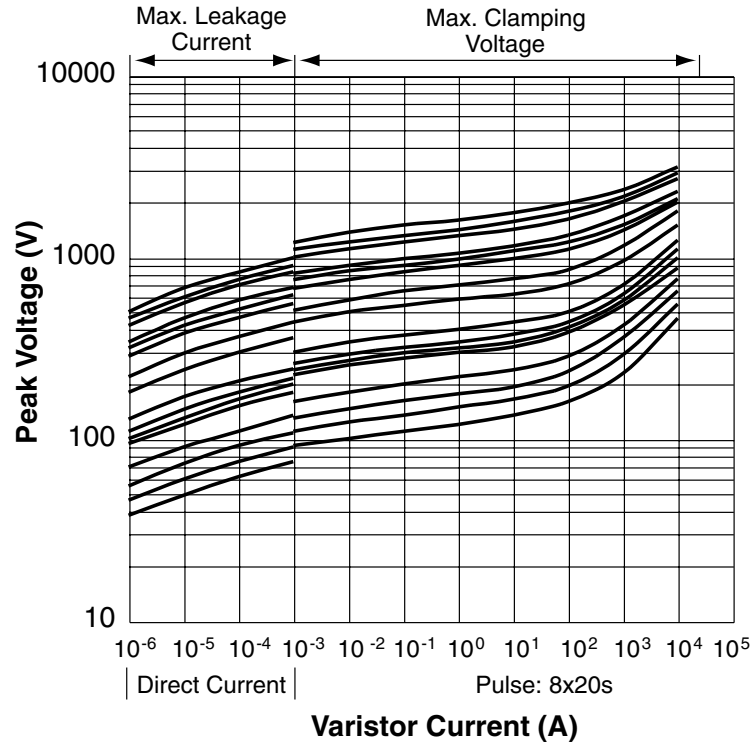

**14mm Disk Size**

- VZ14D112K - (Top line on graph)
- VZ14D911K
- VZ14D821K
- VZ14D681K
- VZ14D621K
- VZ14D471K
- VZ14D431K
- VZ14D391K
- VZ14D361K
- VZ14D271K
- VZ14D241K
- VZ14D201K
- VZ14D151K
- VZ14D121K
- VZ14D101K
- VZ14D820K - (Bottom line on graph)

(Also applies to "E" series parts)

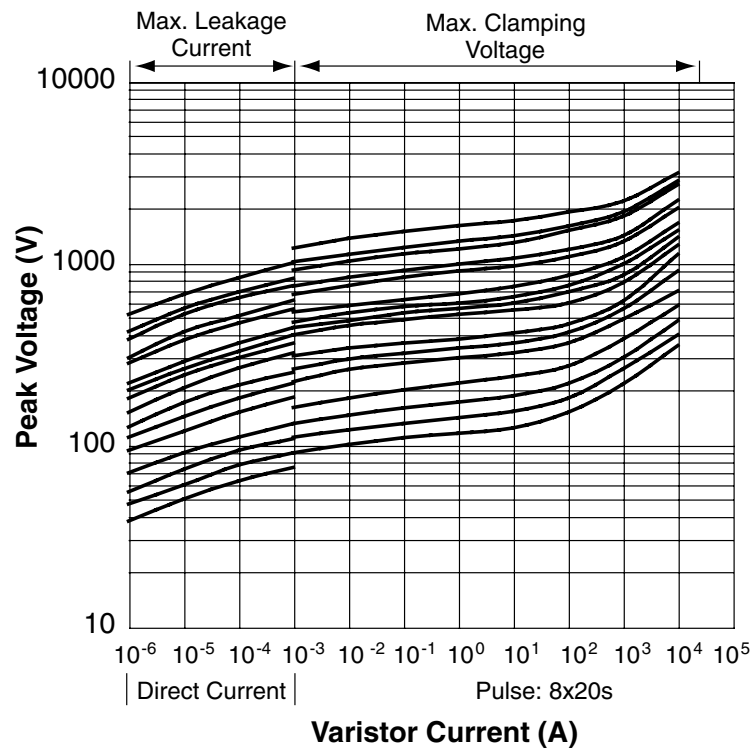

At idle power, current levels shown to the left of the diskontinuity illustrate typically the high end leakage current. However, if lower leakage current levels are desired, they may be guaranteed. In the clamping voltage region to the right of the diskontinuity, maximum clamping voltage is plotted.

**V-I Characteristics (continued)**

**18mm Disk Size**

- VZ18E951K - (Top line on graph)
- VZ18E911K
- VZ18E821K
- VZ18E751K
- VZ18E681K
- VZ18E621K
- VZ18E511K
- VZ18E471K
- VZ18E431K
- VZ18E391K
- VZ18E361K
- VZ18E271K
- VZ18E241K
- VZ18E201K - (Bottom line on graph)

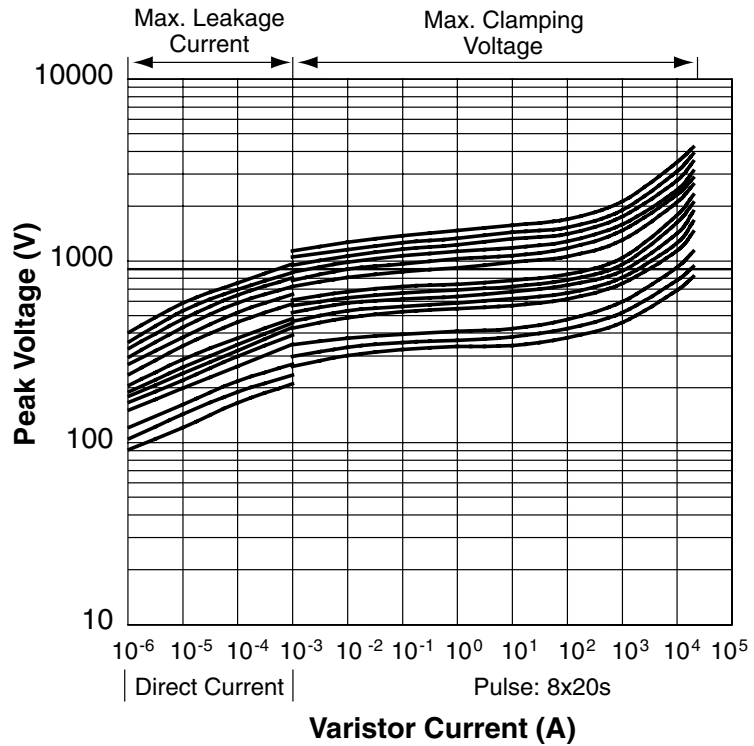

**20mm Disk Size**

- VZ20D112K - (Top line on graph)
- VZ20D911K
- VZ20D821K
- VZ20D681K
- VZ20D471K
- VZ20D431K
- VZ20D391K
- VZ20D271K
- VZ20D241K
- VZ20D221K
- VZ20D201K
- VZ20D151K
- VZ20D121K
- VZ20D101K
- VZ20D820K - (Bottom line on graph)

(Also applies to "E" series parts)

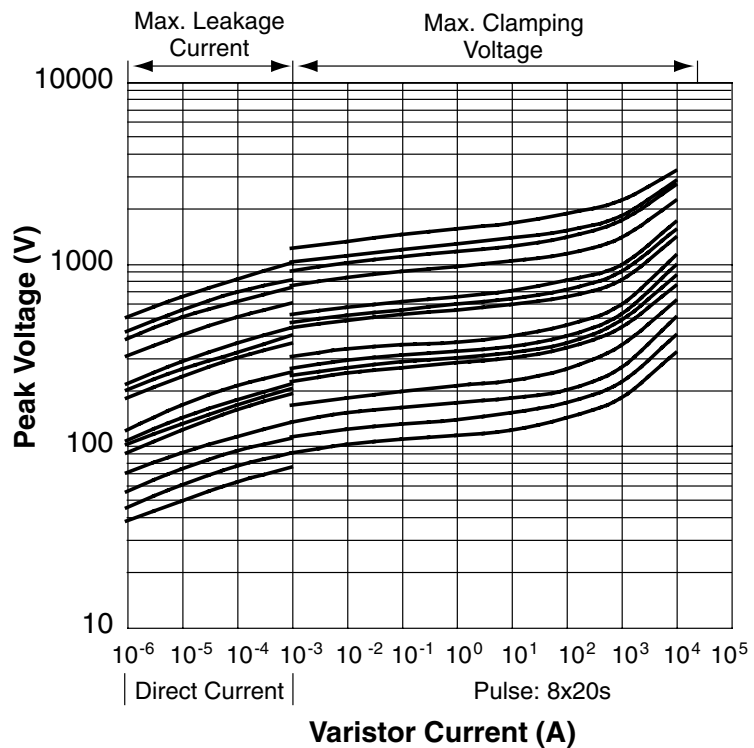

At idle power, current levels shown to the left of the diskontinuity illustrate typically the high end leakage current. However, if lower leakage current levels are desired, they may be guaranteed. In the clamping voltage region to the right of the diskontinuity, maximum clamping voltage is plotted.

**V-I Characteristics (continued)**

**25mm Disk Size**

- VZ25D951K - (Top line on graph)
- VZ25D911K
- VZ25D821K
- VZ25D751K
- VZ25D681K
- VZ25D621K
- VZ25D511K
- VZ25D471K
- VZ25D431K
- VZ25D391K
- VZ25D361K
- VZ25D271K
- VZ25D241K
- VZ25D201K - (Bottom line on graph)

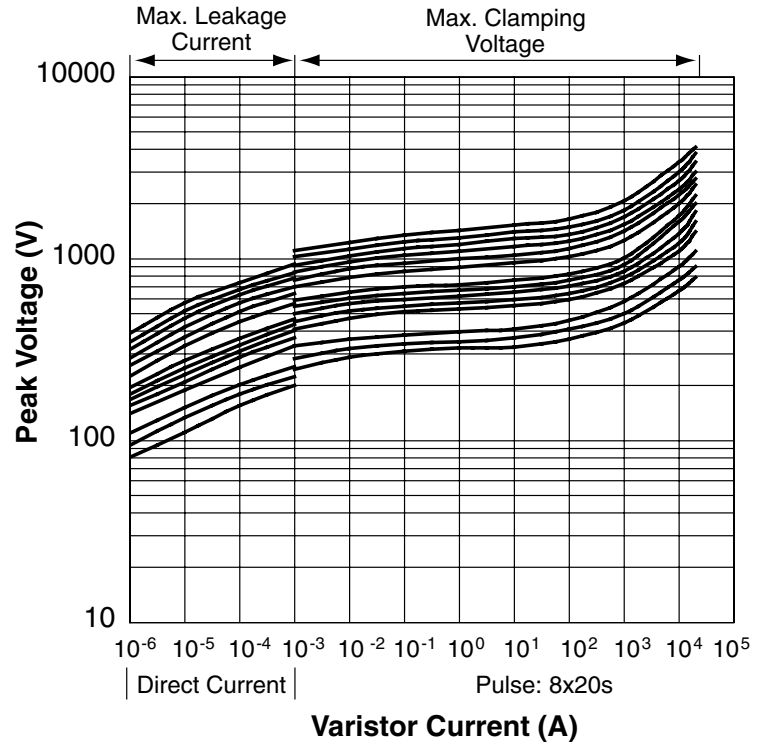

**32mm Disk Size**

- VZ32D951K - (Top line on graph)
- VZ32D911K
- VZ32D821K
- VZ32D751K
- VZ32D681K
- VZ32D621K
- VZ32D511K
- VZ32D471K
- VZ32D431K
- VZ32D391K
- VZ32D361K
- VZ32D271K
- VZ32D241K
- VZ32D201K - (Bottom line on graph)

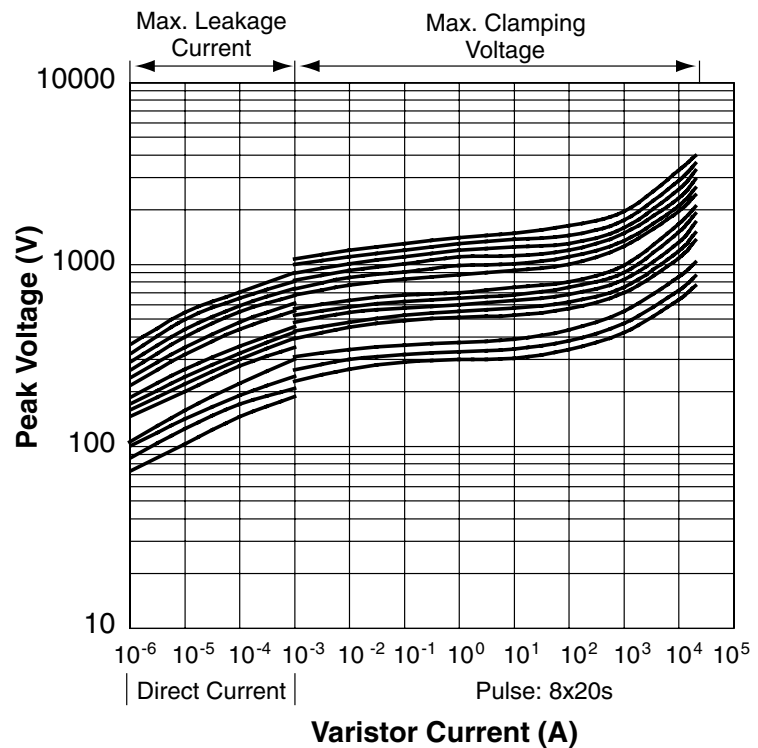

At idle power, current levels shown to the left of the diskontinuity illustrate typically the high end leakage current. However, if lower leakage current levels are desired, they may be guaranteed. In the clamping voltage region to the right of the diskontinuity, maximum clamping voltage is plotted.

**V-I Characteristics (continued)**

**34mm Disk Size**

- VZ34D951K - (Top line on graph)
- VZ34D911K
- VZ34D821K
- VZ34D751K
- VZ34D681K
- VZ34D621K
- VZ34D511K
- VZ34D471K
- VZ34D431K
- VZ34D391K
- VZ34D361K
- VZ34D271K
- VZ34D241K
- VZ32D201K - (Bottom line on graph)

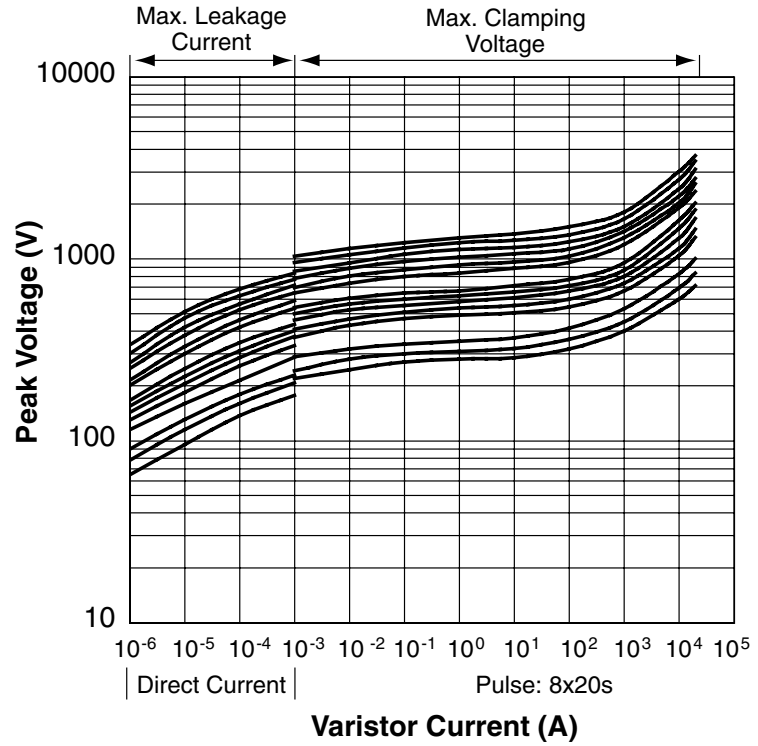

**40mm Disk Size**

- VZ40D951K - (Top line on graph)
- VZ40D911K
- VZ40D821K
- VZ40D751K
- VZ40D681K
- VZ40D621K
- VZ40D511K
- VZ40D471K
- VZ40D431K
- VZ40D391K
- VZ40D361K
- VZ40D271K
- VZ40D241K
- VZ40D201K - (Bottom line on graph)

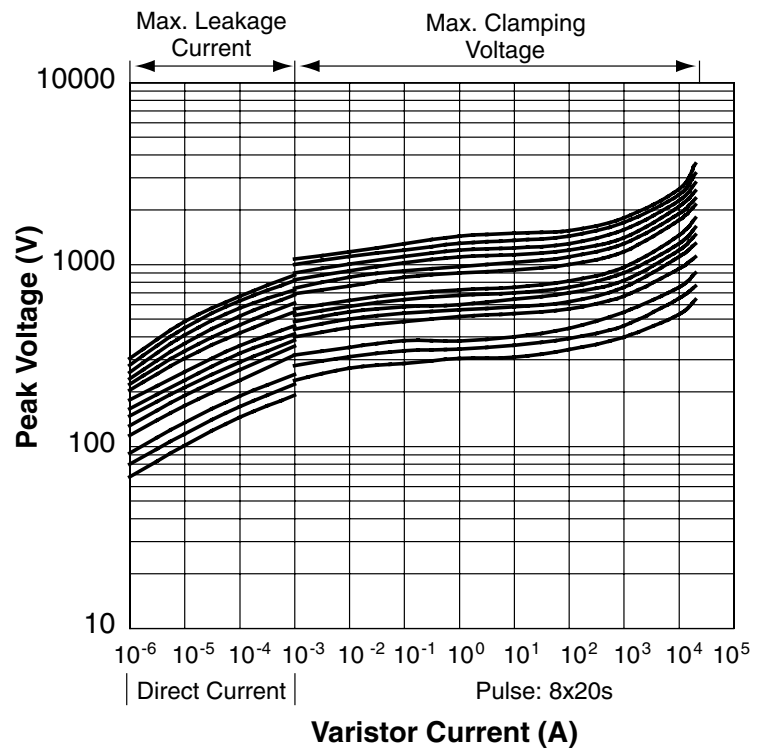

At idle power, current levels shown to the left of the diskontinuity illustrate typically the high end leakage current. However, if lower leakage current levels are desired, they may be guaranteed. In the clamping voltage region to the right of the diskontinuity, maximum clamping voltage is plotted.

## V-I Characteristics (continued)

### 53mm Disk Size

VZ53D951K - (Top line on graph)  
 VZ53D911K  
 VZ53D821K  
 VZ53D751K  
 VZ53D681K  
 VZ53D621K  
 VZ53D511K  
 VZ53D471K  
 VZ53D431K  
 VZ53D391K  
 VZ53D361K  
 VZ53D271K  
 VZ53D241K  
 VZ53D201K - (Bottom line on graph)

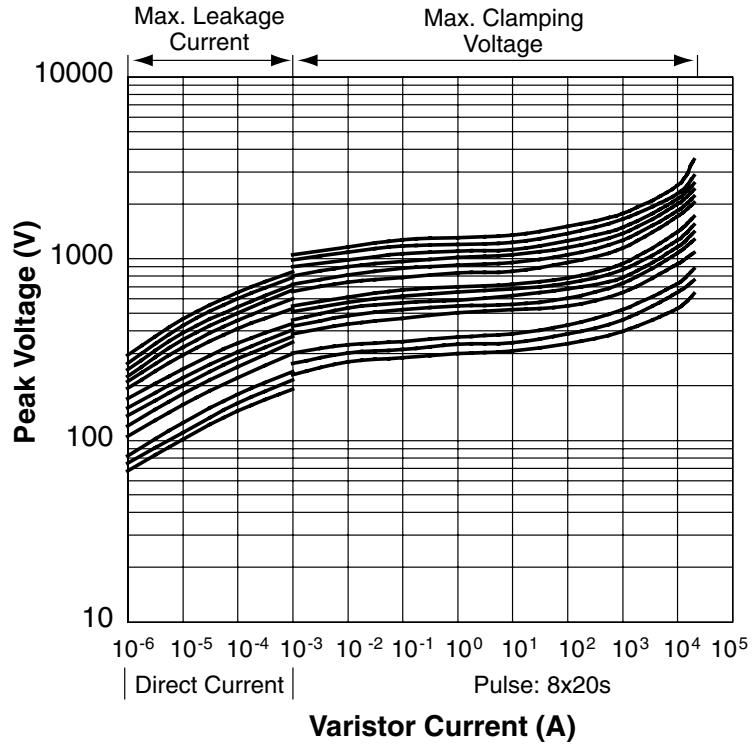

## Soldering Profile

### Standard Product

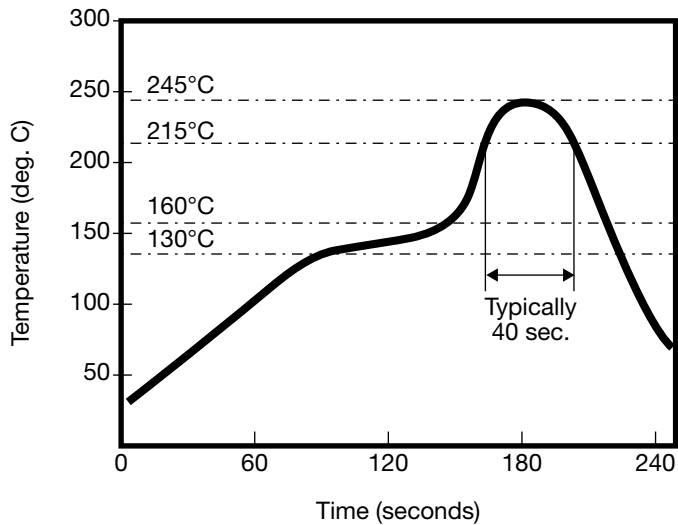

### RoHS Compliant Product

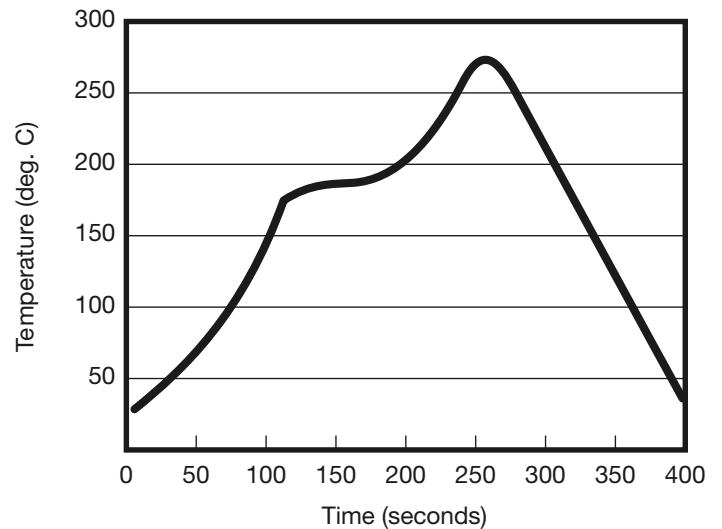

1. RT to 160°: 100-150 second
2. 150° to 200°: around 60 seconds
3. 200° to 270°: around 60 seconds
4. Peak temperature and time: 270±5°: 3 ±0.5sec
5. 270° to RT: at least 120 seconds

At idle power, current levels shown to the left of the diskontinuity illustrate typically the high end leakage current. However, if lower leakage current levels are desired, they may be guaranteed. In the clamping voltage region to the right of the diskontinuity, maximum clamping voltage is plotted.



**THIS PAGE WAS INTENTIONALLY LEFT BLANK.**

## 5mm / 7mm Taping Specifications

Item	Symbol	5mm Disk Size		7mm Disk Size	
		T11, T1	T17, T3, T1D, T14, T1W, T32	T11, T1	T17, T3, T1D, T14, T1W, T32
Body Diameter	D	7 max	7 max	9.5 max	9.5 max
Lead Wire Diameter	d	0.6 ± 0.02	0.6 ± 0.02	0.6 ± 0.02	0.6 ± 0.02
Pitch of Component	P	12.7 ± 1	12.7 ± 1	12.7 ± 1	12.7 ± 1
Feed Hole Pitch	P0	12.7 ± 0.3	12.7 ± 0.3	12.7 ± 0.3	12.7 ± 0.3
Feed Hole Center to Lead	P1	3.85 ± 0.7	3.85 ± 0.7	3.85 ± 0.7	3.85 ± 0.7
Lead to Lead Distance (Center to Center)	F	5 ± 0.8	5 ± 0.8	5 ± 0.8	5 ± 0.8
Component Alignment	△h	2.0 max	2.0 max	2.0 max	2.0 max
Basepaper Tape Width	W	18 +1/-0.5	18 +1/-0.5	18 +1/-0.5	18 +1/-0.5
Adhesive Tape Width	W0	10 min	10 min	10 min	10 min
Hole Position	W1	9 ± 0.5	9 ± 0.5	9 ± 0.5	9 ± 0.5
Adhesive Tape Border	W2	3 max	3 max	3 max	3 max
Component Height	H1	30 max	30 max	32 max	32 max
Lead-Wire Clinch Height	H0	—	16 ± 0.5	—	16 ± 0.5
Lead-Wire Protrusion	Lx	1.0 max	1.0 max	1.0 max	1.0 max
Feed Hole Diameter	D0	4 ± 0.2	4 ± 0.2	4 ± 0.2	4 ± 0.2
Total Tape Thickness	t	»0.7 max	»0.7 max	»0.7 max	»0.7 max
Length of Clipped Lead	L	11 max	11 max	11 max	11 max
Component Height from Seating Plane	A	—	13 max	—	15 max
Hole Center to Component Center	P2	6.35 ± .7	6.35 ± .7	6.35 ± .7	6.35 ± .7

All dimensions are in Millimeters.

Note: Basepaper Thickness = 0.375mm ± 0.1mm (Ammo Box), 0.53mm ± 0.1mm (Reel)

Adhesive Tape Thickness = 0.16mm ± 0.03mm

Largest voltage which can be taped is 420VAC. For 320VAC and larger, only T1W or T32 is available

**5mm / 7mm Taping Specifications (continued)**

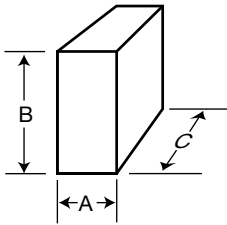

**Ammo Box**

5mm and 7mm Disk Size, (T11, T17, T1D, T1W)

A = 50 max, B = 300 max, C = 340 max

- 2,000 pieces (5 $\emptyset$ )
- < 250VAC = 1,500 pieces (7 $\emptyset$ )
- $\geq$  250VAC = 1,000 pieces (7 $\emptyset$ )

All dimensions are in Millimeters.

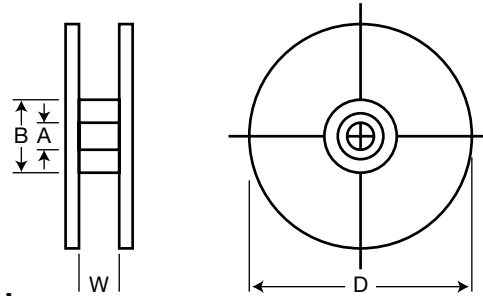

**Reel**

5mm and 7mm Disk Size, (T1, T3, T14, T32)

- W = Approximately 50, D = 350 $\emptyset$ max,
- A = Approximately 30 $\emptyset$ , B = Approximately 95 $\emptyset$
- 2,000 pieces (5 $\emptyset$ )
- < 250VAC = 1,500 pieces (7 $\emptyset$ )
- $\geq$  250VAC = 1,000 pieces (7 $\emptyset$ )

**Straight Lead  
T11 (Ammo Box) and T1 (Reel)**

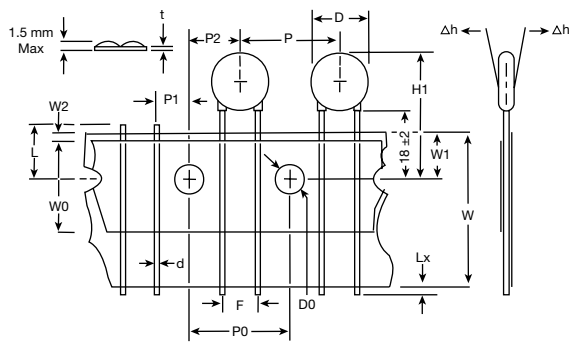

**Outward Crimp  
T17 (Ammo Box) and T3 (Reel)**

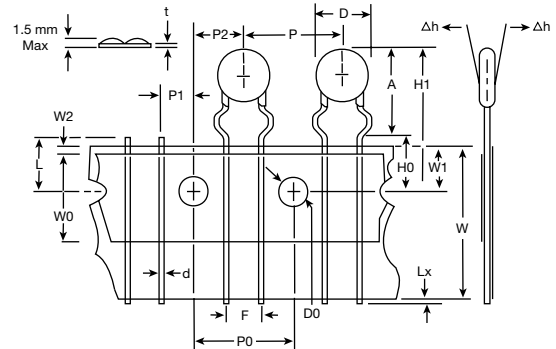

**Inward Crimp  
T1D (Ammo Box) and T14 (Reel)**

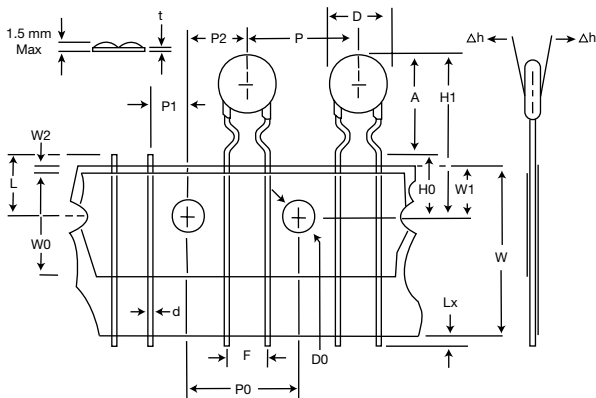

**In-Line Crimp  
T1W (Ammo Box) and T32 (Reel)**

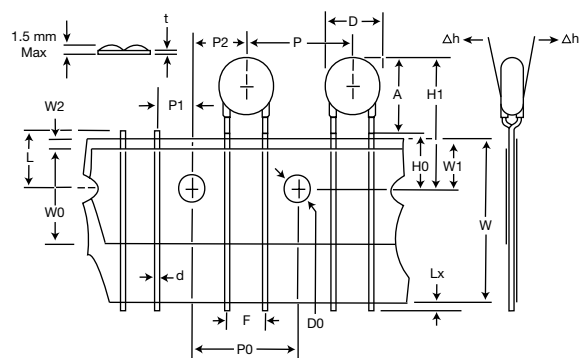

Based on EIA-468-B Specifications.

## 10mm Taping Specifications

Item	Symbol	Straight Leads		Outward Crimp		Inline Crimp		Inward Crimp	
		T36, T19	T7, T18	T1U, T1N	T10, T26	T43, T4	T15, T38	T8, T16	T6, T12
Body Diameter	D	12.5 max	12.5 max	12.5 max	12.5 max	12.5 max	12.5 max	12.5 max	12.5 max
Lead Wire Diameter	d	0.8 ± 0.06	0.8 ± 0.06	0.8 ± 0.06	0.8 ± 0.06	0.8 ± 0.06	0.8 ± 0.06	0.8 ± 0.06	0.8 ± 0.06
Pitch of Component	P	25.4 ± 1	25.4 ± 1	25.4 ± 1	25.4 ± 1	25.4 ± 1	25.4 ± 1	25.4 ± 1	25.4 ± 1
Feed Hole Pitch	P0	12.7 ± 0.3	12.7 ± 0.3	12.7 ± 0.3	12.7 ± 0.3	12.7 ± 0.3	12.7 ± 0.3	12.7 ± 0.3	12.7 ± 0.3
Feed Hole Center to Lead	P1		3.85 ± 0.7		3.85 ± 0.7		3.85 ± 0.7		3.85 ± 0.7
Lead to Lead Distance (Center to Center)	F	7.5 ± 0.8	5.0 ± 0.8	7.5 ± 0.8	5.0 ± 0.8	7.5 ± 0.8	5.0 ± 0.8	7.5 ± 0.8	5.0 ± 0.8
Component Alignment	Δh	2.0 max	2.0 max	2.0 max	2.0 max	2.0 max	2.0 max	2.0 max	2.0 max
Basepaper Tape Width	W	18 +1/-0.5	18 +1/-0.5	18 +1/-0.5	18 +1/-0.5	18 +1/-0.5	18 +1/-0.5	18 +1/-0.5	18 +1/-0.5
Adhesive Tape Width	W0	10 min	10 min	10 min	10 min	10 min	10 min	10 min	10 min
Hole Position	W1	9 ± 0.5	9 ± 0.5	9 ± 0.5	9 ± 0.5	9 ± 0.5	9 ± 0.5	9 ± 0.5	9 ± 0.5
Adhesive Tape Border	W2	3 max	3 max	3 max	3 max	3 max	3 max	3 max	3 max
Component Height	H1	33 max	33 max	38.5 max	38.5 max	35.5 max	38.5 max	38.5 max	38.5 max
Lead-Wire Protrusion	Lx	1.0 max	1.0 max	1.0 max	1.0 max	1.0 max	1.0 max	1.0 max	1.0 max
Feed Hole Diameter	D0	4 ± 0.2	4 ± 0.2	4 ± 0.2	4 ± 0.2	4 ± 0.2	4 ± 0.2	4 ± 0.2	4 ± 0.2
Total Tape Thickness	t	»0.7 max	»0.7 max	»0.7 max	»0.7 max	»0.7 max	»0.7 max	»0.7 max	»0.7 max
Length of Clipped Lead	L	11 max	11 max	11 max	11 max	11 max	11 max	11 max	11 max
Component Height from Seating Plane	A	—	—	19.5 max	19.5 max	19.5 max	19.5 max	19.5 max	19.5 max
Hole Center to Component Center	P2		6.35 ± 0.7		6.35 ± 0.7		6.35 ± 0.7		6.35 ± 0.7

All dimensions are in Millimeters.

Note: Basepaper Thickness = 0.375mm ± 0.1mm (Ammo Box), 0.53mm ± 0.1mm (Reel)

Adhesive Tape Thickness = 0.16mm ± 0.03mm

Largest voltage which can be taped is 460VAC. For 320VAC and larger, only T15, T43, T38 or T4 is available

## 10mm Taping Specifications (continued)

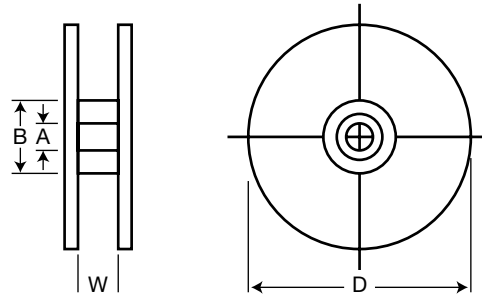
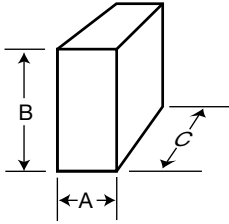

### Ammo Box

Ammo Box Taping Codes  
(T7, T36, T15, T43, T1U, T10, T8, T6)

A = 65 max  
B = 250 max  
C = 340 max

< 300VAC = 500 to 1,000 pieces  
≥ 300VAC = 300 pieces

All dimensions are in Millimeters.

### Reel

Reel Taping Codes  
(T19, T18, T4, T38, T26, T1N, T16, T12)

W = Approximately 50  
D = 350ømax  
A = Approximately 30ø  
B = Approximately 95ø

< 300VAC = 500 to 1,000 pieces  
≥ 300VAC = 300 pieces

10mm Taping Specifications (continued)

**Straight Lead**  
**T7 ( Ammo Box) and T18 (Reel)**  
**(5mm Lead Spacing)**

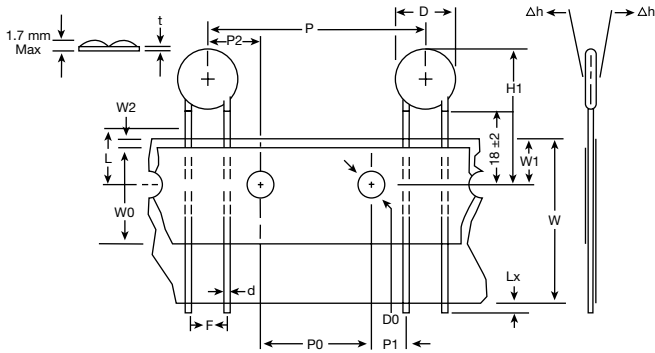

**Straight Lead**  
**T36 ( Ammo Box) and T19 (Reel)**  
**(7.5mm Lead Spacing)**

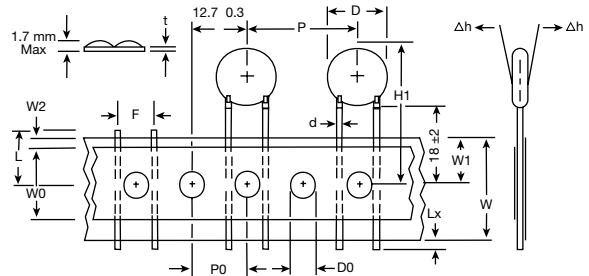

**In-Line Crimp**  
**T15 ( Ammo Box) and T38 (Reel)**  
**(5mm Lead Spacing)**

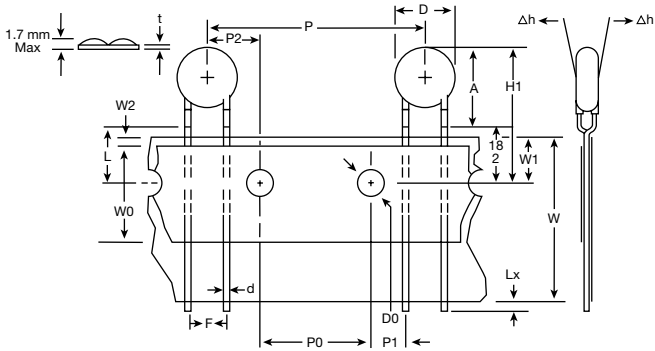

**In-Line Crimp**  
**T43 ( Ammo Box) and T4 (Reel)**  
**(7.5mm Lead Spacing)**

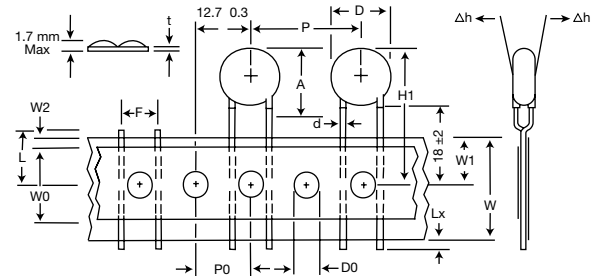

Based on EIA-468-B Specifications.

10mm Taping Specifications (continued)

**Outward Crimp**  
**T10 ( Ammo Box ) and T26 ( Reel )**  
**( 5mm Lead Spacing )**

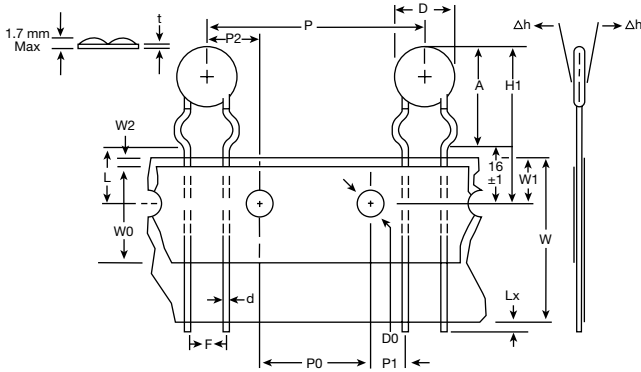

**Outward Crimp**  
**T1U ( Ammo Box ) and T1N ( Reel )**  
**( 7.5mm Lead Spacing )**

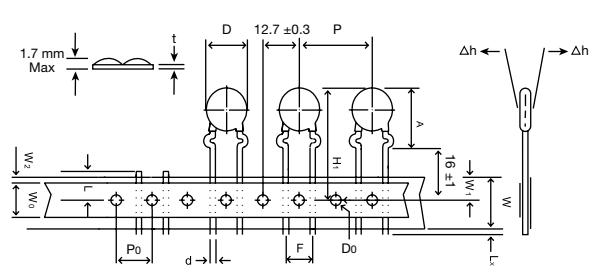

**Inward Crimp**  
**T6 ( Ammo Box ) and T12 ( Reel )**  
**( 5mm Lead Spacing )**

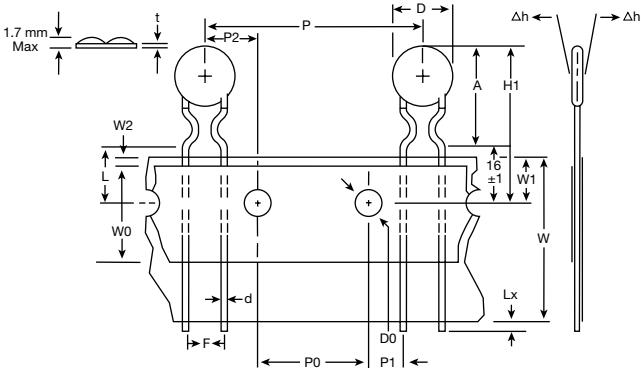

**Inward Crimp**  
**T8 ( Ammo Box ) and T16 ( Reel )**  
**( 7.5mm Lead Spacing )**

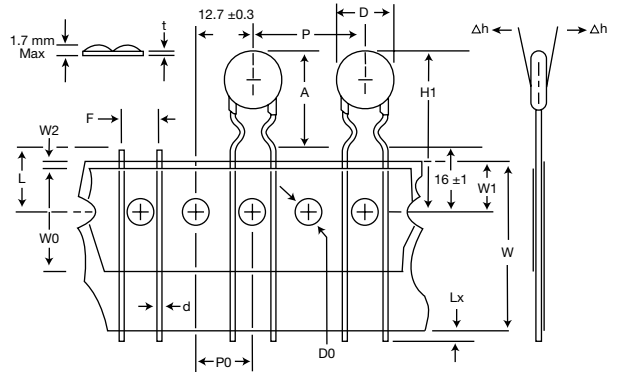

Based on EIA-468-B Specifications.

## 14mm Taping Specifications

Item	Symbol	Straight Leads		Outward Crimp		Inline Crimp		Inward Crimp	
		T36, T19	T7, T18	T1U, T1N	T10, T26	T43, T4	T15, T38	T8, T16	T6, T12
Body Diameter	D	16.5 max	16.5 max	16.5 max	16.5 max	16.5 max	16.5 max	16.5 max	16.5 max
Lead Wire Diameter	d	0.8 ± 0.06	0.8 ± 0.06	0.8 ± 0.06	0.8 ± 0.06	0.8 ± 0.06	0.8 ± 0.06	0.8 ± 0.06	0.8 ± 0.06
Pitch of Component	P	25.4 ± 1	25.4 ± 1	25.4 ± 1	25.4 ± 1	25.4 ± 1	25.4 ± 1	25.4 ± 1	25.4 ± 1
Feed Hole Pitch	P0	12.7 ± 0.3	12.7 ± 0.3	12.7 ± 0.3	12.7 ± 0.3	12.7 ± 0.3	12.7 ± 0.3	12.7 ± 0.3	12.7 ± 0.3
Feed Hole Center to Lead	P1		3.85 ± 0.7		3.85 ± 0.7		3.85 ± 0.7		3.85 ± 0.7
Lead to Lead Distance (Center to Center)	F	7.5 ± 0.8	5.0 ± 0.8	7.5 ± 0.8	5.0 ± 0.8	7.5 ± 0.8	5.0 ± 0.8	7.5 ± 0.8	5.0 ± 0.8
Component Alignment	Δh	2.0 max	2.0 max	2.0 max	2.0 max	2.0 max	2.0 max	2.0 max	2.0 max
Basepaper Tape Width	W	18 +1/-0.5	18 +1/-0.5	18 +1/-0.5	18 +1/-0.5	18 +1/-0.5	18 +1/-0.5	18 +1/-0.5	18 +1/-0.5
Adhesive Tape Width	W0	10 min	10 min	10 min	10 min	10 min	10 min	10 min	10 min
Hole Position	W1	9 ± 0.5	9 ± 0.5	9 ± 0.5	9 ± 0.5	9 ± 0.5	9 ± 0.5	9 ± 0.5	9 ± 0.5
Adhesive Tape Border	W2	3 max	3 max	3 max	3 max	3 max	3 max	3 max	3 max
Component Height	H1	37 max	37 max	40 max	40 max	40 max	40 max	40 max	40 max
Lead-Wire Protrusion	Lx	1.0 max	1.0 max	1.0 max	1.0 max	1.0 max	1.0 max	1.0 max	1.0 max
Feed Hole Diameter	D0	4 ± 0.2	4 ± 0.2	4 ± 0.2	4 ± 0.2	4 ± 0.2	4 ± 0.2	4 ± 0.2	4 ± 0.2
Total Tape Thickness	t	»0.7 max	»0.7 max	»0.7 max	»0.7 max	»0.7 max	»0.7 max	»0.7 max	»0.7 max
Length of Clipped Lead	L	11 max	11 max	11 max	11 max	11 max	11 max	11 max	11 max
Component Height from Seating Plane	A	—	—	22.5 max	22.5 max	22.5 max	22.5 max	22.5 max	22.5 max
Hole Center to Component Center	P2		6.35 ± 0.7		6.35 ± 0.7		6.35 ± 0.7		6.35 ± 0.7

All dimensions are in Millimeters.

Note: Basepaper Thickness = 0.375mm ± 0.1mm (Ammo Box), 0.53mm ± 0.1mm (Reel)

Adhesive Tape Thickness = 0.16mm ± 0.03mm

Largest voltage which can be taped is 460VAC. For 320VAC and larger, only T15, T43, T38 or T4 is available



## 14mm Taping Specifications (continued)

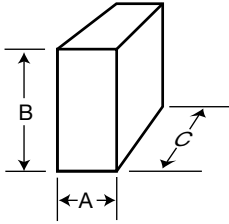

### Ammo Box

Ammo Box Taping Codes  
(T7, T36, T15, T43, T1U, T10, T8, T6)

A = 65 max  
B = 250 max  
C = 340 max

< 300VAC = 500 to 1,000 pieces  
≥ 300VAC = 300 pieces

**All dimensions are in Millimeters.**

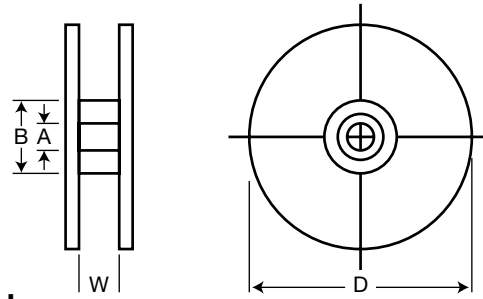

### Reel

Reel Taping Codes  
(T19, T18, T4, T38, T26, T1N, T16, T12)

W = Approximately 50  
D = 350ømax  
A = Approximately 30ø  
B = Approximately 95ø

< 300VAC = 500 to 1,000 pieces  
≥ 300VAC = 300 pieces

14mm Taping Specifications (continued)

**Straight Lead**  
**T7 (Ammo Box) and T18 (Reel)**  
**(5mm Lead Spacing)**

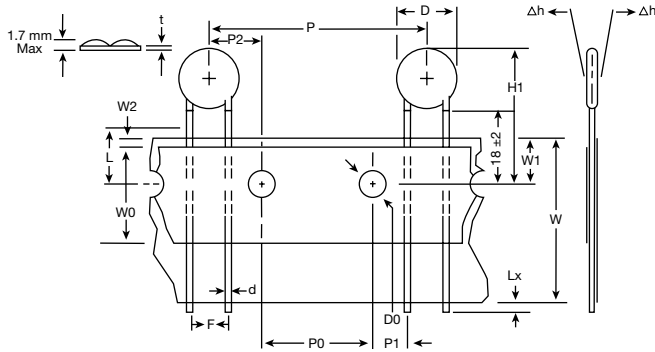

**Straight Lead**  
**T36 (Ammo Box) and T19 (Reel)**  
**(7.5mm Lead Spacing)**

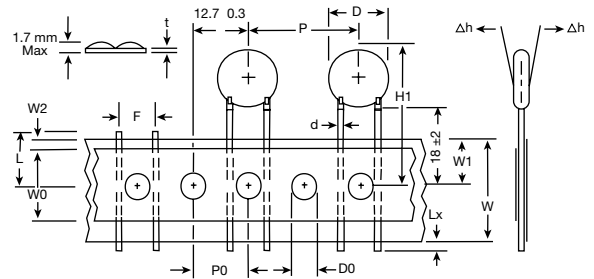

**In-Line Crimp**  
**T15 (Ammo Box) and T38 (Reel)**  
**(5mm Lead Spacing)**

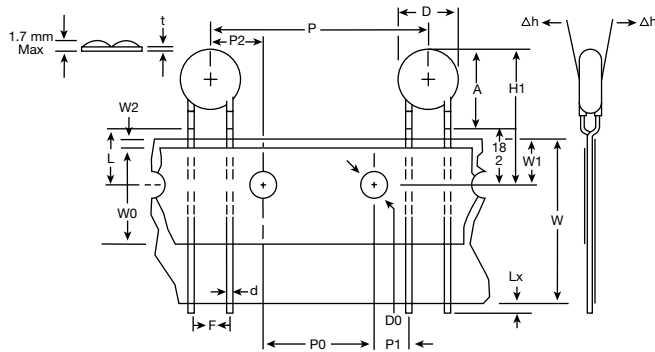

**In-Line Crimp**  
**T43 (Ammo Box) and T4 (Reel)**  
**(7.5mm Lead Spacing)**

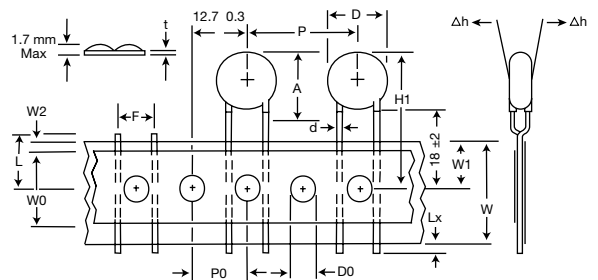

Based on EIA-468-B Specifications.

14mm Taping Specifications (continued)

**Outward Crimp**  
**T10 ( Ammo Box) and T26 ( Reel)**  
**(5mm Lead Spacing)**

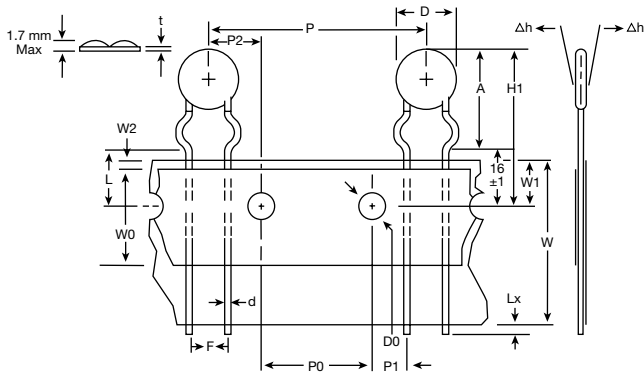

**Outward Crimp**  
**T1U ( Ammo Box) and T1N ( Reel)**  
**(7.5mm Lead Spacing)**

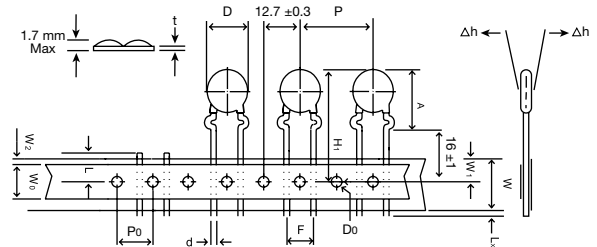

**Inward Crimp**  
**T6 ( Ammo Box) and T12 ( Reel)**  
**(5mm Lead Spacing)**

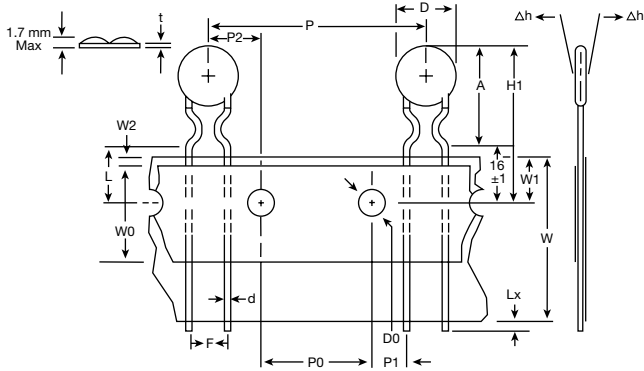

**Inward Crimp**  
**T8 ( Ammo Box) and T16 ( Reel)**  
**(7.5mm Lead Spacing)**

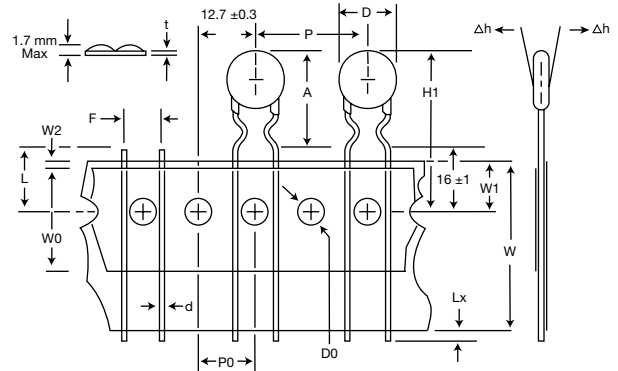

## 18mm / 20mm Taping Specifications

Item	Symbol	Straight Leads		Outward Crimp		Inline Crimp		Inward Crimp	
		T44, T1H	T5, T30	T1X, T45	T50, T2X	T2, T25	T60, T3X	T40, T4X	T35, T2D
Body Diameter	D	*24 max	*24 max	*24 max	*24 max	*24 max	*24 max	*24 max	*24 max
Lead Wire Diameter	d	0.8 ± 0.06	1.0 ± 0.1	0.8 ± 0.06	1.0 ± 0.1	0.8 ± 0.06	1.0 ± 0.1	0.8 ± 0.06	1.0 ± 0.1
Pitch of Component	P	25.4 ± 1	25.4 ± 1	25.4 ± 1	25.4 ± 1	25.4 ± 1	25.4 ± 1	25.4 ± 1	25.4 ± 1
Feed Hole Pitch	P0	12.7 ± 0.3	12.7 ± 0.3	12.7 ± 0.3	12.7 ± 0.3	12.7 ± 0.3	12.7 ± 0.3	12.7 ± 0.3	12.7 ± 0.3
Lead to Lead Distance (Center to Center)	F	7.5 ± 0.8	10 ± 1	7.5 ± 0.8	10 ± 1	7.5 ± 0.8	10 ± 1	7.5 ± 0.8	10 ± 1
Component Alignment	Δh	2.0 max	2.0 max	2.0 max	2.0 max	2.0 max	2.0 max	2.0 max	2.0 max
Basepaper Tape Width	W	18+1/-0.5	18+1/-0.5	18+1/-0.5	18+1/-0.5	18+1/-0.5	18+1/-0.5	18+1/-0.5	18+1/-0.5
Adhesive Tape Width	W0	10 min	10 min	10 min	10 min	10 min	10 min	10 min	10 min
Hole Position	W1	9 ± 0.5	9 ± 0.5	9 ± 0.5	9 ± 0.5	9 ± 0.5	9 ± 0.5	9 ± 0.5	9 ± 0.5
Adhesive Tape Border	W2	3 max	3 max	3 max	3 max	3 max	3 max	3 max	3 max
Component Height	H1	*48 max	*48 max	*48 max	*48 max	*48 max	*48 max	*48 max	*48 max
Lead-Wire Clinch Height	H0	18 ± 2	18 ± 2	16 ± 1	16 ± 1	16 ± 1	16 ± 1	16 ± 1	16 ± 1
Lead-Wire Protrusion	Lx	1.0 max	1.0 max	1.0 max	1.0 max	1.0 max	1.0 max	1.0 max	1.0 max
Feed Hole Diameter	D0	4 ± 0.2	4 ± 0.2	4 ± 0.2	4 ± 0.2	4 ± 0.2	4 ± 0.2	4 ± 0.2	4 ± 0.2
Total Tape Thickness	t	»0.7 max	»0.7 max	»0.7 max	»0.7 max	»0.7 max	»0.7 max	»0.7 max	»0.7 max
Length of Clipped Lead	L	11 max	11 max	11 max	11 max	11 max	11 max	11 max	11 max
Component Height from Seating Plane	A	—	—	*29 max	*29 max	*31 max	*31 max	*29 max	*29 max

All dimensions are in Millimeters.

Note: Basepaper Thickness = 0.375mm ± 0.1mm (Ammo Box), 0.53mm ± 0.1mm (Reel).

Adhesive Tape Thickness = 0.16mm ± 0.03mm.

\* - 18mm disk size dimensions: D = 22 max, H1 = 46 max, A = 26 max.

Largest voltage which can be taped is 460VAC.

For 320VAC and larger, only T2, T25, T60 or T3X is available

## 18mm / 20mm Taping Specifications (continued)

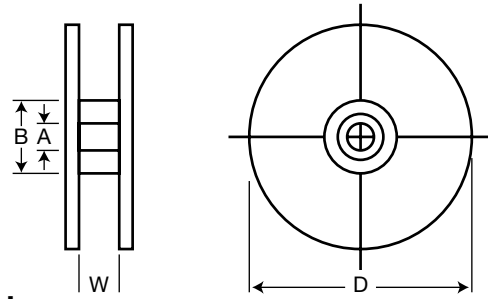
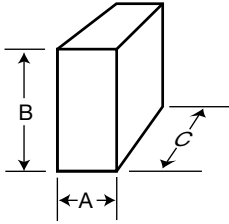

### Ammo Box

Ammo Box Taping Codes  
(T44, T5, T2, T60, T45, T50, T40, T35)

A = 65 max, B = 250 max  
C = 340 max

< 300VAC = 500 pieces, ≥ 300VAC = 300 pieces

### Reel

Reel Taping Codes  
(T1H, T30, T25, T3X, T1X, T2X, T4X, T2D)

A = Approx. 30 $\phi$ , B = Approx. 95 $\phi$   
W = Approx. 50, D = 350 $\phi$ max

< 300VAC = 500 pieces, ≥ 300VAC = 300 pieces

All dimensions are in Millimeters.

### Straight Lead

T44 (Ammo Box) and T1H (Reel) (7.5mm Lead Spacing)  
T5 (Ammo Box) and T30 (Reel) (10mm Lead Spacing)

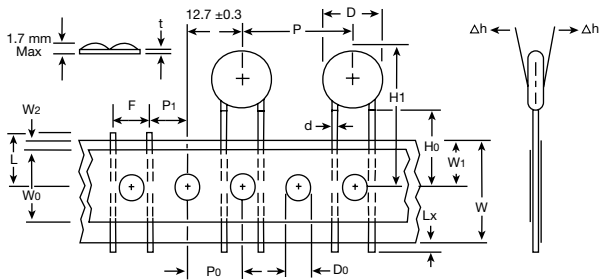

### In-Line Crimp

T2 (Ammo Box) and T25 (Reel) (7.5mm Lead Spacing)  
T60 (Ammo Box) and T3X (Reel) (10mm Lead Spacing)

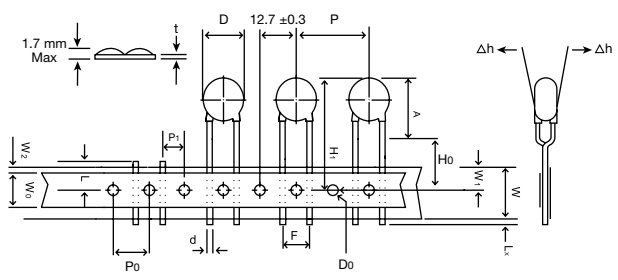

### Outward Crimp

T45 (Ammo Box) and T1X (Reel) (7.5mm Lead Spacing)  
T50 (Ammo Box) and T2X (Reel) (10mm Lead Spacing)

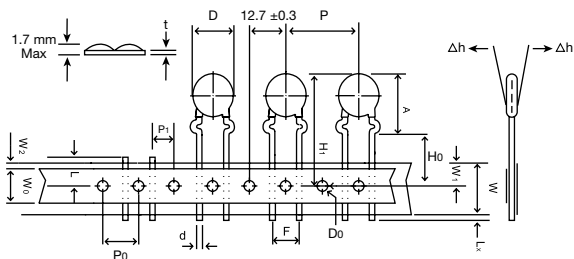

### Inward Crimp

T40 (Ammo Box) and T4X (Reel) (7.5mm Lead Spacing)  
T35 (Ammo Box) and T2D (Reel) (10mm Lead Spacing)

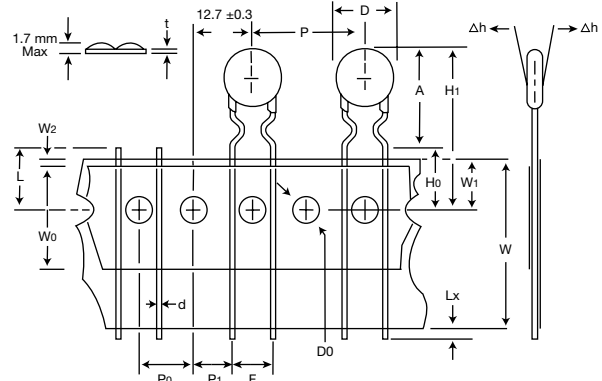

Based on EIA-468-B Specifications.

## Standard Bulk Packaging

Disk Size mm	Varistor Voltage	Quantity pieces/bag	Quantity pieces/carton
Diameter 05	ALL	1000	10000
Diameter 07	ALL	500	5000
Diameter 10	180K-471K	500	5000
	Above 511K	300	3000
Diameter 14	180K-751K	300	3000
	Above 781K	200	2000
Diameter 18	ALL	200	2000
Diameter 20	180K-621K	100	1000
	Above 681K	50	500
Diameter 25	180K-621K	50	500
	Above 681K	30	300
Disk Size mm	Varistor Voltage	Quantity pieces/box	Quantity pieces/carton
32D (wire lead type)	201K-391K	80	320
	431K-621K	60	240
	681K-122K	40	160
32D	201K-391K	80	320
	431K-621K	60	240
	681K-122K	40	160
34R	201K-391K	80	320
	431K-621K	60	240
	681K-122K	40	160
40D	201K-391K	80	320
	431K-621K	60	240
	681K-122K	40	160
53D	201K-391K	80	320
	431K-621K	60	240
	681K-122K	40	160

## Applications

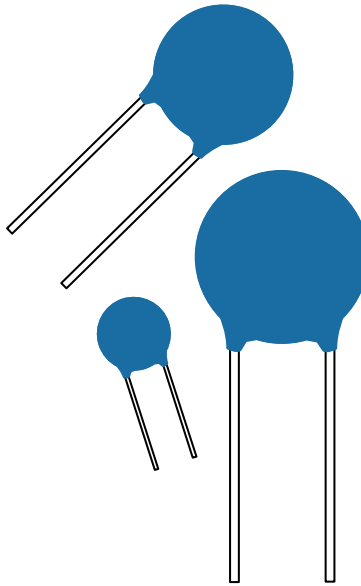

**Metal Oxide Varistors** are transient voltage surge suppression products. Used in both AC and DC applications, these devices clamp transient voltages and divert transient currents. Metal oxide Varistors are available in the widest range of voltages and current handling sizes.

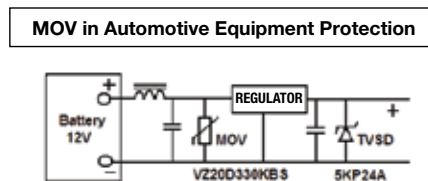
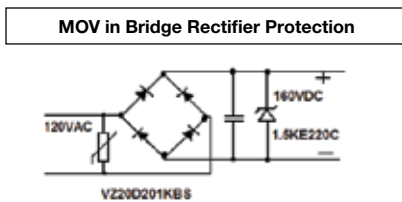
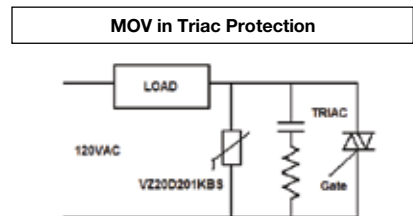
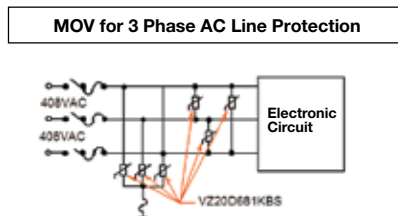
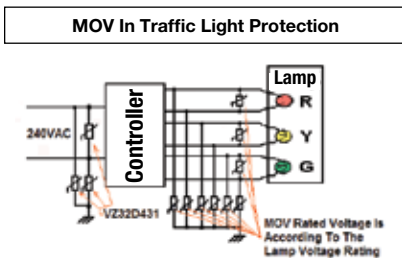
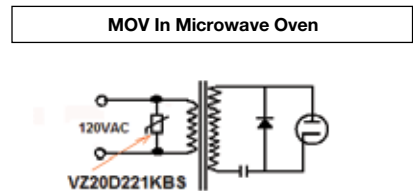
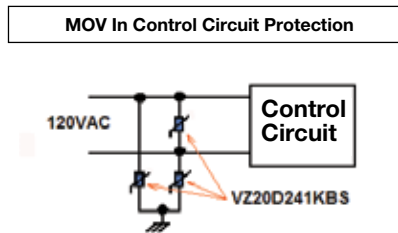
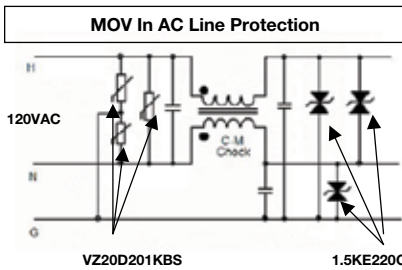

All application notes/circuits are shown as examples only. It is the responsibility of the purchaser to insure that the application meets purchaser's specifications. No representation or warranty, whether express or implied, is given and no liability is assumed by WPI with respect to the use of such examples.

WPI Reserves Copyright

## Circuit Examples

### Data Line Protection

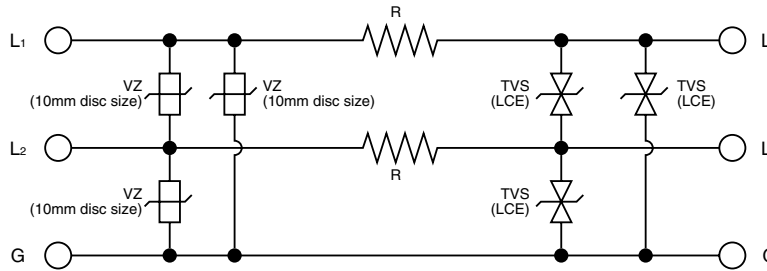

### 120VAC Line Protection

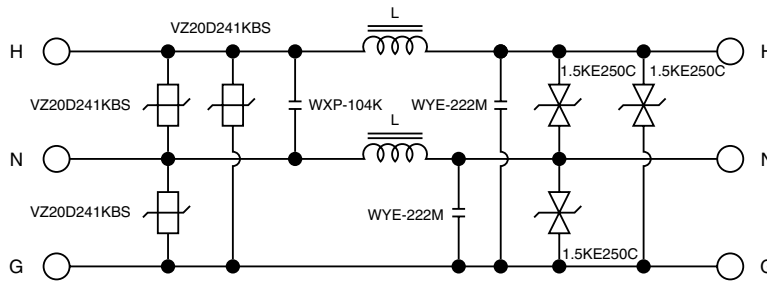

WXP = World Products RFI Suppressor "X Type" (Across-the-Line)  
WYE = World Products RFI Suppressor "Y Type" (Line-to-Ground)

### 240VAC Line Protection

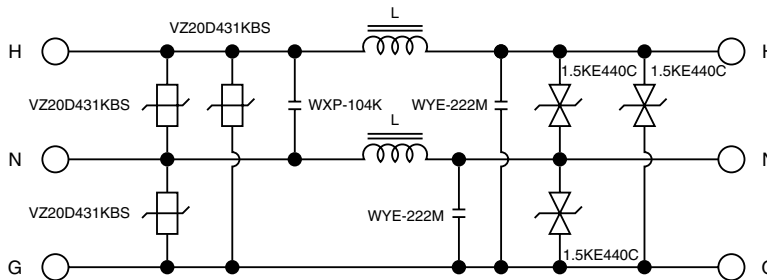

WXP = World Products RFI Suppressor "X Type" (Across-the-Line)  
WYE = World Products RFI Suppressor "Y Type" (Line-to-Ground)

### Telecom Circuit Protection

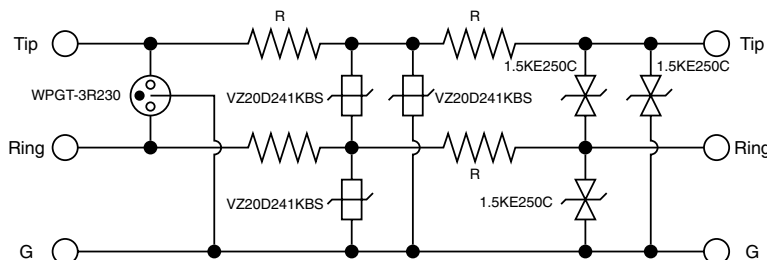

**DISCLAIMER:** The names of the products and the specifications in this catalog are subject to change without notice for the sake of improvement. World Products, LLC also reserves the right to discontinue any of these products. The products in this catalog are intended for use in ordinary electronic products. If any of these products are to be used in special applications requiring extremely high reliability, where product defects might pose a safety risk, please consult World Products, LLC. Though World Products, LLC has taken all possible precautions to ensure the quality and reliability of its products, improper use of products may result in bodily injury, fire, or similar accident. If you have any questions regarding the use of the products in question, please consult World Products, LLC. Please be advised that World Products, LLC accepts no responsibility for any infraction by users of World Products, LLC products on third party patents or industrial copyrights.



**THIS PAGE WAS INTENTIONALLY LEFT BLANK.**