

Schottky Rectifier, 2 x 7.5 A

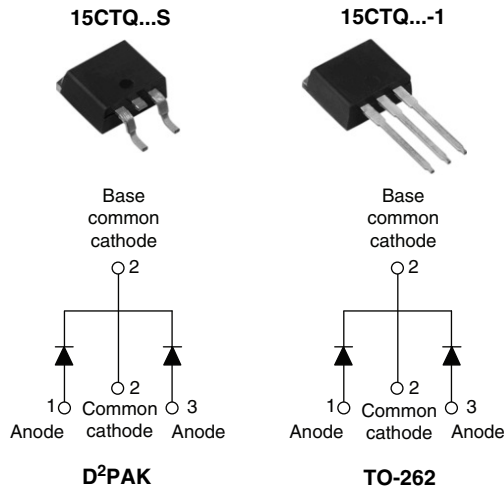

FEATURES

- 150 °C T_J operation
- Center tap TO-220 package
- Low forward voltage drop
- High frequency operation
- High purity, high temperature epoxy encapsulation for enhanced mechanical strength and moisture resistance
- Guard ring for enhanced ruggedness and long term reliability
- Designed and qualified for Q101 level

DESCRIPTION

The 15CTQ center tap Schottky rectifier series has been optimized for very low forward voltage drop, with moderate leakage. The proprietary barrier technology allows for reliable operation up to 150 °C junction temperature. Typical applications are in switching power supplies, converters, freewheeling diodes, and reverse battery protection.

PRODUCT SUMMARY

$I_{F(AV)}$	2 x 7.5 A
V_R	35 to 45 V

MAJOR RATINGS AND CHARACTERISTICS

SYMBOL	CHARACTERISTICS	VALUES	UNITS
$I_{F(AV)}$	Rectangular waveform	15	A
V_{RRM}	Range	35 to 45	V
I_{FSM}	$t_p = 5 \mu s$ sine	810	A
V_F	7.5 Apk, $T_J = 125^\circ C$ (per leg)	0.51	V
T_J	Range	- 55 to 150	°C

VOLTAGE RATINGS

PARAMETER	SYMBOL	15CTQ035S 15CTQ035-1	15CTQ040S 15CTQ040-1	15CTQ045S 15CTQ045-1	UNITS
Maximum DC reverse voltage	V_R	35	40	45	V
Maximum working peak reverse voltage	V_{RWM}				

ABSOLUTE MAXIMUM RATINGS

PARAMETER	SYMBOL	TEST CONDITIONS	VALUES	UNITS
Maximum average forward current See fig. 5	$I_{F(AV)}$	50 % duty cycle at $T_C = 123^\circ C$, rectangular waveform	15	A
Maximum peak one cycle non-repetitive surge current per leg See fig. 7	I_{FSM}	5 μs sine or 3 μs rect. pulse	Following any rated load condition and with rated V_{RRM} applied	810
		10 ms sine or 6 ms rect. pulse		145
Non-repetitive avalanche energy per leg	E_{AS}	$T_J = 25^\circ C$, $I_{AS} = 1.20$ A, $L = 11.10$ mH	10	mJ
Repetitive avalanche current per leg	I_{AR}	Current decaying linearly to zero in 1 μs Frequency limited by T_J maximum $V_A = 1.5 \times V_R$ typical	1.5	A

ELECTRICAL SPECIFICATIONS					
PARAMETER	SYMBOL	TEST CONDITIONS		VALUES	UNITS
Maximum forward voltage drop per leg See fig. 1	$V_{FM}^{(1)}$	7.5 A	$T_J = 25\text{ }^\circ\text{C}$	0.55	V
		15 A		0.70	
		7.5 A	$T_J = 125\text{ }^\circ\text{C}$	0.51	
		15 A		0.65	
Maximum reverse leakage current per leg See fig. 2	$I_{RM}^{(1)}$	$T_J = 25\text{ }^\circ\text{C}$	$V_R = \text{Rated } V_R$	0.8	mA
		$T_J = 125\text{ }^\circ\text{C}$		32	
Maximum junction capacitance per leg	C_T	$V_R = 5 V_{DC}$ (test signal range 100 kHz to 1 MHz) $25\text{ }^\circ\text{C}$		400	pF
Typical series inductance per leg	L_S	Measured lead to lead 5 mm from package body		8.0	nH
Maximum voltage rate of change	dV/dt	Rated V_R		10 000	V/ μs

Note(1) Pulse width < 300 μs , duty cycle < 2 %

THERMAL - MECHANICAL SPECIFICATIONS				
PARAMETER	SYMBOL	TEST CONDITIONS	VALUES	UNITS
Maximum junction and storage temperature range	T_J, T_{Stg}		- 55 to 150	$^\circ\text{C}$
Maximum thermal resistance, junction to case per leg	R_{thJC}	DC operation See fig. 4	3.50	$^\circ\text{C/W}$
Maximum thermal resistance, junction to case per package		DC operation	1.75	
Typical thermal resistance, case to heatsink	R_{thCS}	Mounting surface, smooth and greased	0.50	
Approximate weight			2	g
			0.07	oz.
Mounting torque	minimum		6 (5)	kgf · cm (lbf · in)
	maximum		12 (10)	
Marking device	Case style D ² PAK		15CTQ035S	
			15CTQ040S	
			15CTQ045S	
	Case style TO-262		15CTQ035-1	
			15CTQ040-1	
			15CTQ045-1	

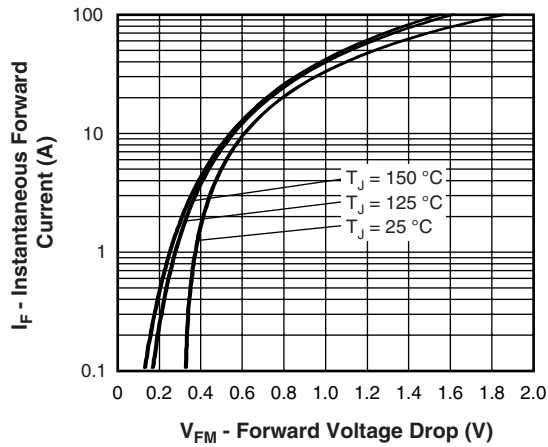

Fig. 1 - Maximum Forward Voltage Drop Characteristics (Per Leg)

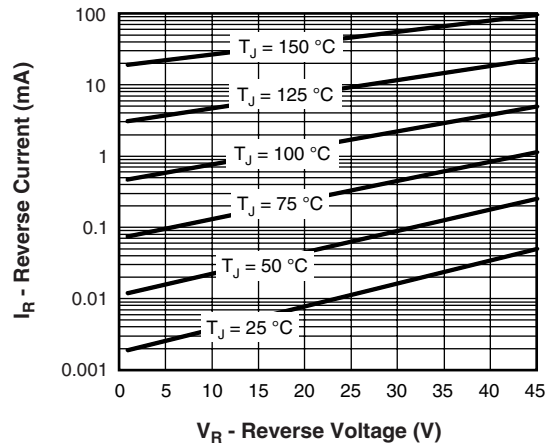

Fig. 2 - Typical Values of Reverse Current vs. Reverse Voltage (Per Leg)

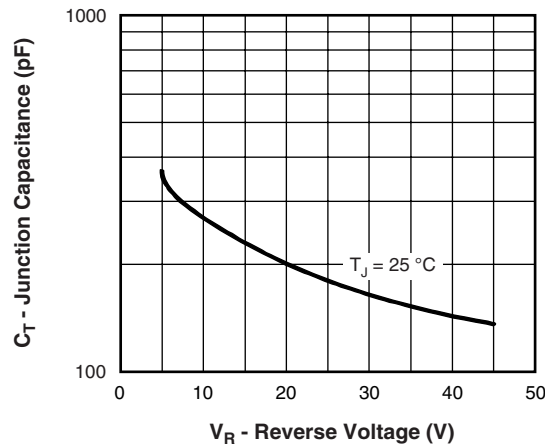

Fig. 3 - Typical Junction Capacitance vs. Reverse Voltage (Per Leg)

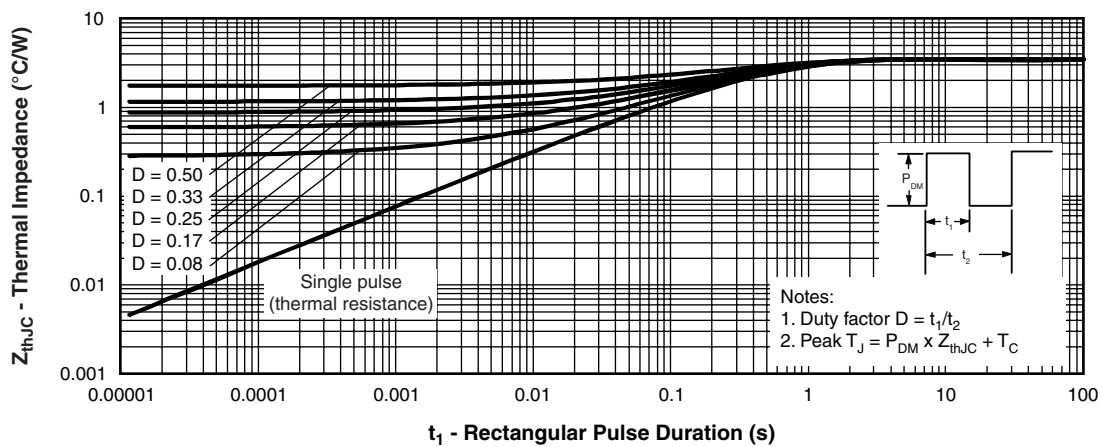

Fig. 4 - Maximum Thermal Impedance Z_{thJC} Characteristics (Per Leg)

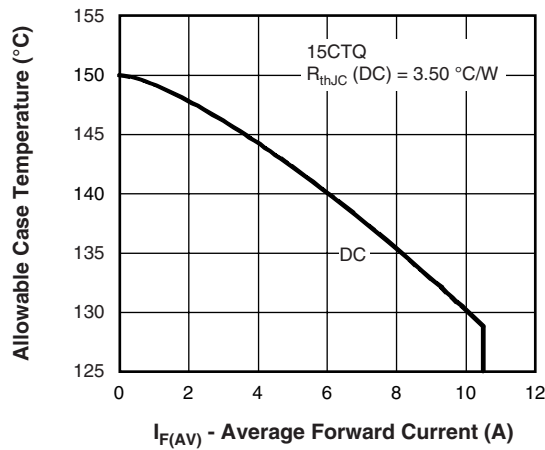

Fig. 5 - Maximum Allowable Case Temperature vs. Average Forward Current (Per Leg)

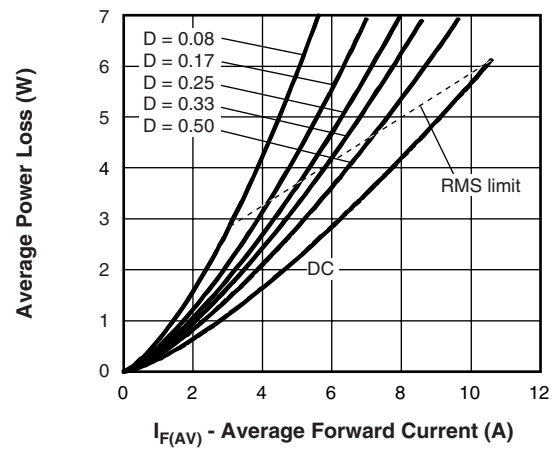

Fig. 6 - Forward Power Loss Characteristics (Per Leg)

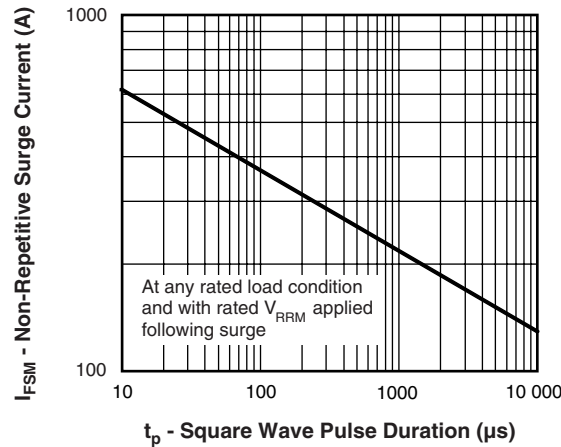

Fig. 7 - Maximum Non-Repetitive Surge Current (Per Leg)



Fig. 8 - Unclamped Inductive Test Circuit



ORDERING INFORMATION TABLE

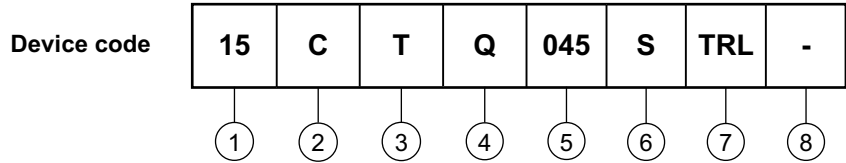

- 1** - Current rating (15 A)
 - 2** - Circuit configuration:
C = Common cathode
 - 3** - T = TO-220
 - 4** - Schottky "Q" series
 - 5** - Voltage ratings
 - 6** - • S = D²PAK
• -1 = TO-262
 - 7** - • None = Tube (50 pieces)
• TRL = Tape and reel (left oriented - for D²PAK only)
• TRR = Tape and reel (right oriented - for D²PAK only)
 - 8** - • None = Standard production
• PbF = Lead (Pb)-free
- | |
|------------|
| 035 = 35 V |
| 040 = 40 V |
| 045 = 45 V |

LINKS TO RELATED DOCUMENTS	
Dimensions	http://www.vishay.com/doc?95014
Part marking information	http://www.vishay.com/doc?95008
Packaging information	http://www.vishay.com/doc?95032



Disclaimer

All product specifications and data are subject to change without notice.

Vishay Intertechnology, Inc., its affiliates, agents, and employees, and all persons acting on its or their behalf (collectively, "Vishay"), disclaim any and all liability for any errors, inaccuracies or incompleteness contained herein or in any other disclosure relating to any product.

Vishay disclaims any and all liability arising out of the use or application of any product described herein or of any information provided herein to the maximum extent permitted by law. The product specifications do not expand or otherwise modify Vishay's terms and conditions of purchase, including but not limited to the warranty expressed therein, which apply to these products.

No license, express or implied, by estoppel or otherwise, to any intellectual property rights is granted by this document or by any conduct of Vishay.

The products shown herein are not designed for use in medical, life-saving, or life-sustaining applications unless otherwise expressly indicated. Customers using or selling Vishay products not expressly indicated for use in such applications do so entirely at their own risk and agree to fully indemnify Vishay for any damages arising or resulting from such use or sale. Please contact authorized Vishay personnel to obtain written terms and conditions regarding products designed for such applications.

Product names and markings noted herein may be trademarks of their respective owners.