

Axial Lead Transient Voltage Suppressors (TVS)

15KPA Series 17 To 280 V 15000W

Description

The 15KPA series is designed specifically to protect sensitive electronic equipment from voltage transients induced by lightning and other transient voltage events.

Features

- u Glass passivated chip junction in P600 Package
- u Low leakage
- u Uni and Bidirectional unit
- u Excellent clamping capability
- u 15000W Peak power capability at 10 × 1000µs waveform Repetition rate (duty cycle):0.01%
- u Fast response time: typically less than 1.0ps from 0 Volts to V_{BR} min
- u Typical I_R less than 2µA above 40V.
- u High Temperature soldering: 260°C/40 seconds at terminals
- u Typical maximum temperature coefficient $\Delta V_{BR} = 0.1\% \times V_{BR}@25^\circ\text{C} \times \Delta T$
- u Plastic package has Underwriters Laboratory Flammability 94V-0
- u Matte tin lead-free Plated
- u Halogen free and RoHS compliant
- u Typical failure mode is short from over-specified voltage or current
- u Whisker test is conducted based on JEDEC JESD201A per its table 4a and 4c
- u IEC-61000-4-2 ESD 15kV(Air), 8kV (Contact)
- u ESD protection of data lines in accordance with IEC 61000-4-2 (IEC801-2)
- u EFT protection of data lines in accordance with IEC 61000-4-4 (IEC801-4)

Uni-directional

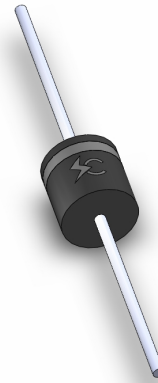

Bi-directional

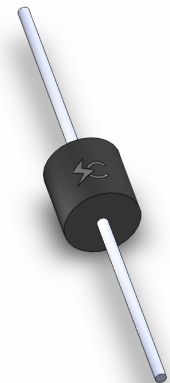

Functional Diagram

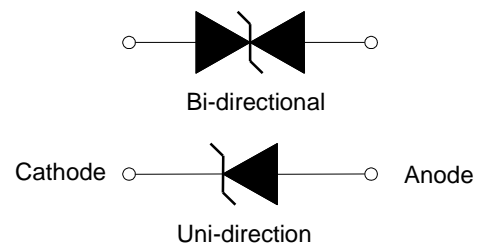

Applications

TVS devices are ideal for the protection of I/O interfaces, V_{CC} bus and other vulnerable circuits used in Telecom, Computer, Industrial and Consumer electronic applications.

Maximum Ratings ($T_A=25^\circ\text{C}$ unless otherwise noted)

Parameter	Symbol	Value	Unit
Peak Pulse Power Dissipation with a 10/1000µs waveform (Fig.1)(Note 1), (Note 2)	P_{PPM}	15000	Watts
Peak Pulse Current with a 10/1000µs waveform.(Note1, Fig.3)	I_{PP}	See Next Table	Amps
Power Dissipation on Infinite Heat Sink at $T_L=75^\circ\text{C}$	$P_{M(AV)}$	8.0	Watt
Peak Forward Surge Current, 8.3ms Single Half Sine Wave (Note 3)	I_{FSM}	500	Amps
Operating junction and Storage Temperature Range.	T_J, T_{STG}	-55 to +150	$^\circ\text{C}$

Notes:

1. Non-repetitive current pulse, per Fig. 3 and derated above $T_A = 25^\circ\text{C}$ per Fig. 2.
2. Mounted on 5.0mm x 5.0mm (0.03mm thick) Copper Pads to each terminal.
3. 8.3ms single half sine-wave, or equivalent square wave, Duty cycle = 4 pulses per minutes maximum.
4. $V_F < 3.5\text{V}$ for $V_{BR} < 200\text{V}$ and $V_F < 6.5\text{V}$ for $V_{BR} > 201\text{V}$.

Axial Lead Transient Voltage Suppressors (TVS)

15KPA Series 17 To 280 V 15000W
Electrical Characteristics ($T_A=25^\circ\text{C}$ unless otherwise noted)

Part Number		Reverse Stand-Off Voltage V_{RWM} (V)	Breakdown Voltage V_{BR} (V) @ I_T		Test Current I_T (mA)	Maximum Clamping Voltage V_C @ I_{PP} (V)	Maximum Peak Pulse Current I_{PP} (A)	Maximum Reverse Leakage I_R @ V_{RWM} (μA)
Uni	Bi		MIN	MAX				
15KPA17A	15KPA17CA	17	18.99	20.79	50	29.3	515.4	5000
15KPA18A	15KPA18CA	18	20.11	22.01	50	30.9	488.7	5000
15KPA20A	15KPA20CA	20	22.34	24.46	20	34.3	440.2	1500
15KPA22A	15KPA22CA	22	24.57	26.91	10	37.1	407.0	500
15KPA24A	15KPA24CA	24	26.81	29.35	5	40.7	371.0	150
15KPA26A	15KPA26CA	26	29.04	31.80	5	44.0	343.2	50
15KPA28A	15KPA28CA	28	31.28	34.24	5	47.5	317.9	25
15KPA30A	15KPA30CA	30	33.51	36.70	5	50.7	297.8	15
15KPA33A	15KPA33CA	33	36.90	40.40	5	54.7	276.1	2
15KPA36A	15KPA36CA	36	40.20	44.00	5	59.8	252.5	2
15KPA40A	15KPA40CA	40	44.70	48.90	5	65.8	229.5	2
15KPA43A	15KPA43CA	43	48.00	52.60	5	69.8	216.3	2
15KPA45A	15KPA45CA	45	50.30	55.00	5	72.8	207.4	2
15KPA48A	15KPA48CA	48	53.60	58.70	5	77.7	194.3	2
15KPA51A	15KPA51CA	51	57.00	62.40	5	82.9	182.1	2
15KPA54A	15KPA54CA	54	60.30	66.00	5	87.7	172.2	2
15KPA58A	15KPA58CA	58	64.80	70.90	5	93.8	161.0	2
15KPA60A	15KPA60CA	60	67.00	73.40	5	97.4	155.0	2
15KPA64A	15KPA64CA	64	71.50	78.30	5	104.2	144.9	2
15KPA70A	15KPA70CA	70	78.20	85.60	5	113.6	132.9	2
15KPA75A	15KPA75CA	75	83.80	91.70	5	122.0	123.8	2
15KPA78A	15KPA78CA	78	87.10	95.40	5	126.1	119.7	2
15KPA85A	15KPA85CA	85	94.90	104.00	5	137.6	109.7	2
15KPA90A	15KPA90CA	90	100.50	110.10	5	145.6	103.7	2
15KPA100A	15KPA100CA	100	111.70	122.30	5	161.3	93.6	2
15KPA110A	15KPA110CA	110	122.90	134.50	5	178.6	84.5	2
15KPA120A	15KPA120CA	120	134.00	146.80	5	192.3	78.5	2
15KPA130A	15KPA130CA	130	145.20	159.00	5	208.3	72.5	2
15KPA150A	15KPA150CA	150	167.60	183.50	5	241.9	62.4	2
15KPA160A	15KPA160CA	160	178.70	195.70	5	258.6	58.4	2
15KPA170A	15KPA170CA	170	189.90	207.90	5	272.7	55.4	2
15KPA180A	15KPA180CA	180	201.10	220.10	5	288.5	52.3	2
15KPA200A	15KPA200CA	200	223.40	244.60	5	319.1	47.3	2
15KPA220A	15KPA220CA	220	245.70	269.10	5	428.6	42.2	2
15KPA240A	15KPA240CA	240	268.10	293.50	5	384.6	39.3	2
15KPA260A	15KPA260CA	260	290.40	318.00	5	416.7	36.2	2
15KPA280A	15KPA280CA	280	312.80	342.40	5	454.5	33.2	2

Note:

- For Bi-Directional devices having V_R of 30 volts and under, the I_R limit is double

Axial Lead Transient Voltage Suppressors (TVS)

15KPA Series 17 To 280 V 15000W

Ratings and Characteristic Curves ($T_A=25^\circ\text{C}$ unless otherwise noted)

Figure 1 - Peak Pulse Power Rating Curve

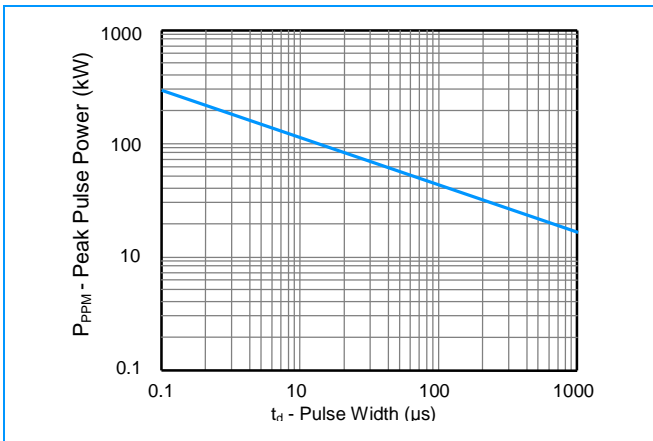

Figure 2 - Pulse Derating Curve

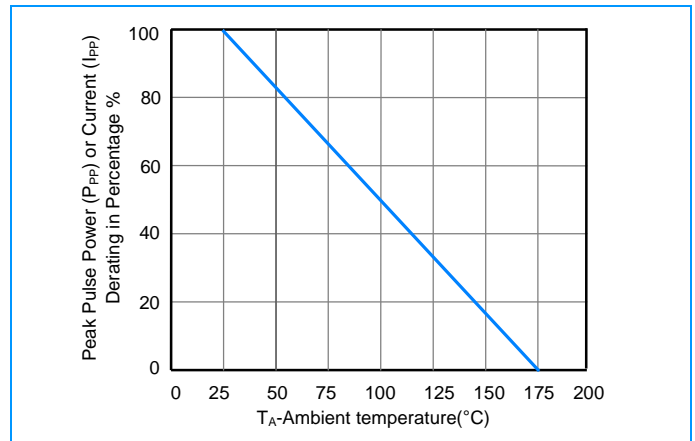

Figure 3 - Pulse Waveform

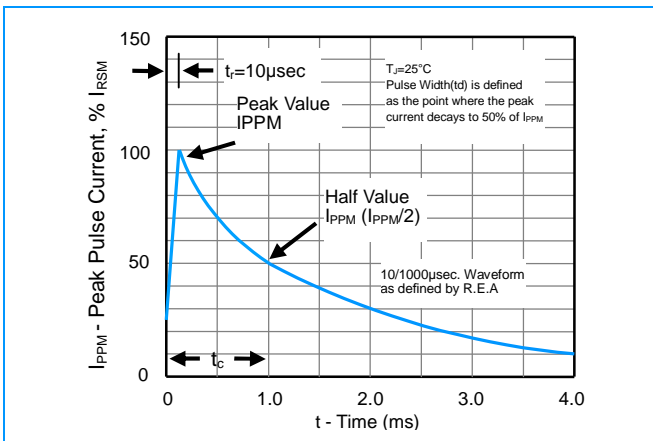

Figure 4 - Typical Junction Capacitance

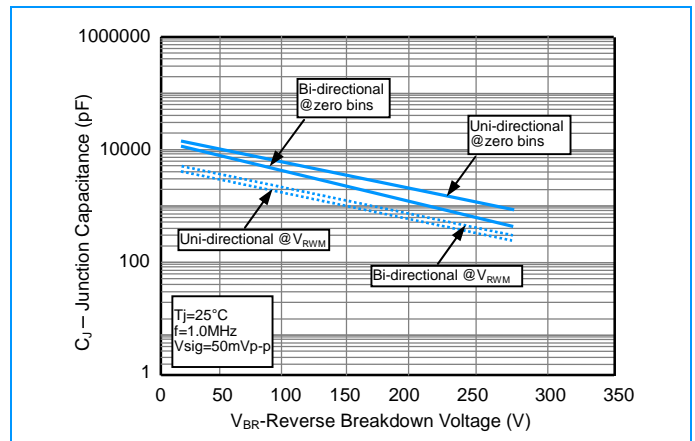

Figure 5 - Steady State Power Derating Curve

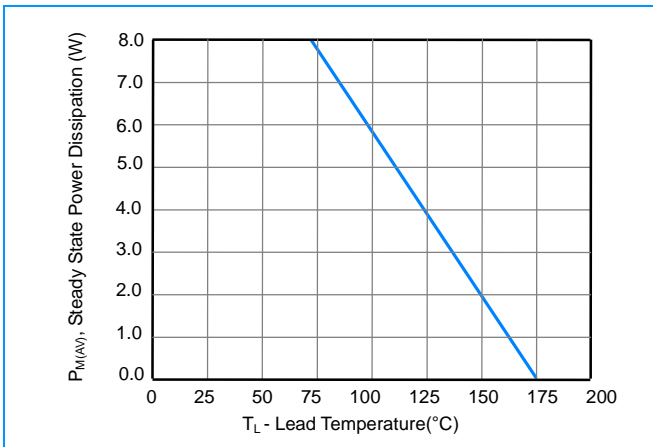
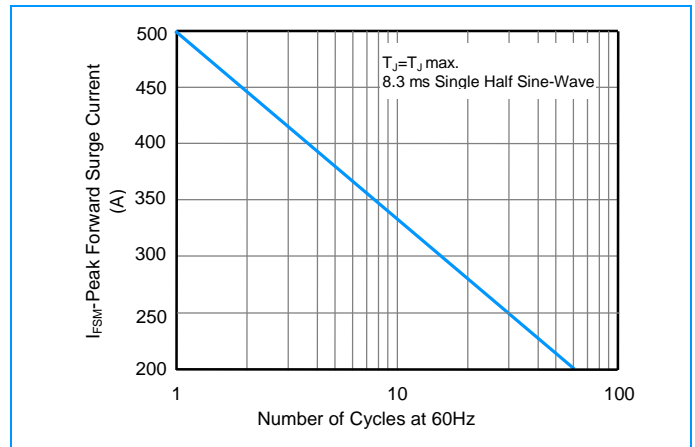

Figure 6 - Maximum Non-Repetitive Surge Current



Axial Lead Transient Voltage Suppressors (TVS)

15KPA Series 17 To 280 V 15000W

I-V Curve Characteristics

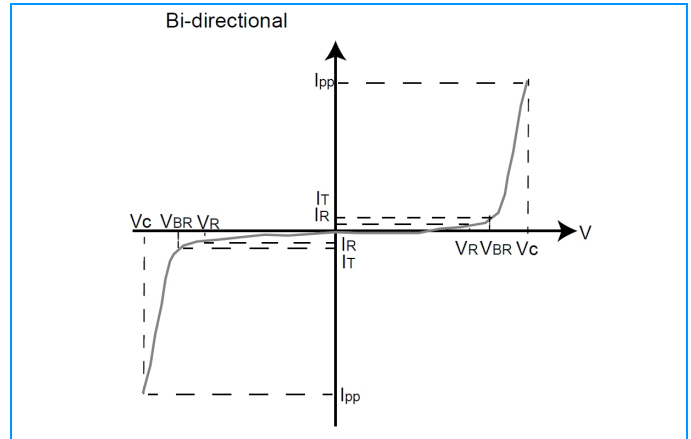
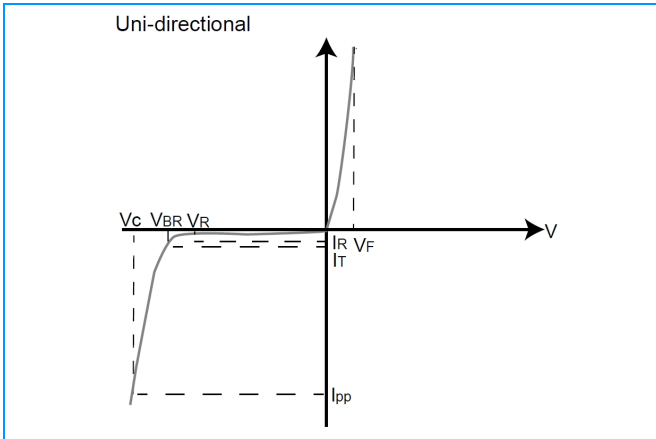

Physical Specifications

Weight	0.07 ounce, 2.1gram
Case	JEDEC R-6/P600 Molded Plastic over glass passivated junction
Polarity	Color band denotes cathode except Bipolar
Terminal	Matte Tin-plated leads, Solderable per JESD22-B102D

Environmental Specifications

Temperature Cycle	JESD22-A104
Pressure Cooker	JESD22-A102
High Temp. Storage	JESD22-A103
HTRB	JESD22-A108
Thermal Shock	JESD22-A106

Soldering Parameters

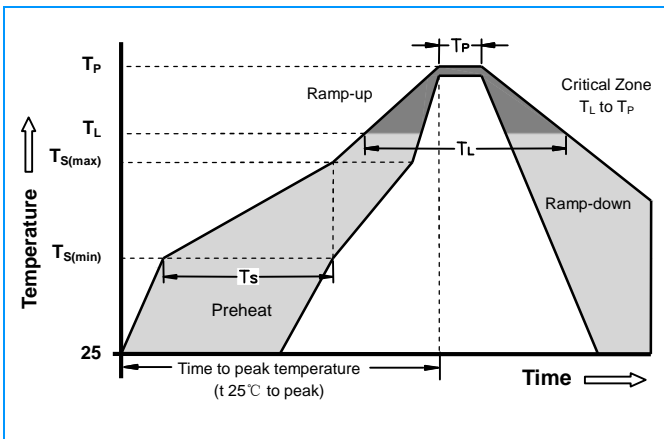

Reflow Condition		Lead-free assembly
Pre Heat	-Temperature Min ($T_{S(min)}$)	150°C
	-Temperature Max ($T_{S(max)}$)	200°C
	- Time (min to max) (T_S)	60 -180 Seconds
Average ramp up rate (Liquidus Temp T_L) to peak		3°C/second max
$T_{S(max)}$ to T_L - Ramp-up Rate		3°C/second max
Reflow	- Temperature (T_L) (Liquidus)	217°C
	- Time (min to max) (T_L)	60 -150 Seconds
Peak Temperature (T_P)		260 +0/-5°C
Time within 5°C of actual peak Temperature (t_p)		20 -40 Seconds
Ramp-down Rate		6°C/second max
Time 25°C to peak Temperature (T_P)		8 minutes Max
Do not exceed		280°C

Axial Lead Transient Voltage Suppressors (TVS)

15KPA Series 17 To 280 V 15000W

Dimensions

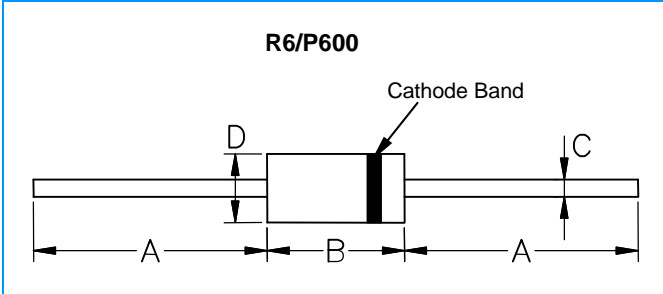

Dimensions	Inches		Millimeters	
	Min	Max	Min	Max
A	1.000	-	25.40	-
B	0.340	0.360	8.64	9.14
C	0.048	0.052	1.22	1.32
D	0.340	0.360	8.64	9.14

Part Numbering

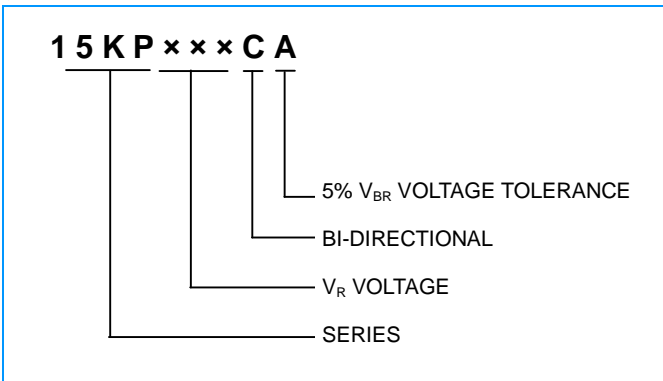

Part Marking

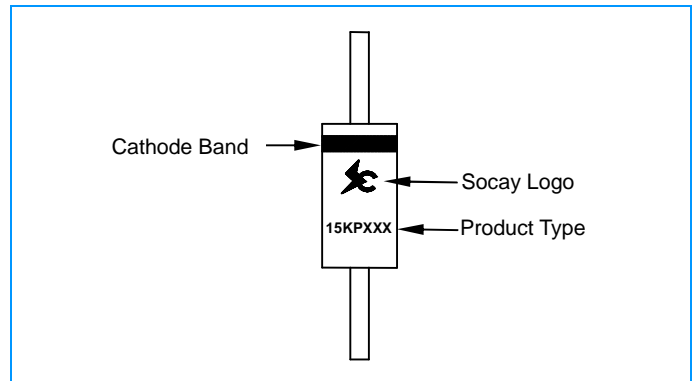

Packaging

Part Number	Component Package	Quantity	Packaging Option
15KPXXXXXX	R6/P600	200	Box

Packaging Dimensions Unit: Inches (Millimeters)

