

POWER TVS COMPONENT

APPLICATIONS

- ✓ Relay Drives
- ✓ Motor (Start/Stop) Back EMF Protection
- ✓ Module Lightning Protection
- ✓ Secondary Lightning Protection for AC/DC

IEC COMPATIBILITY (EN61000-4)

- ✓ 61000-4-5 (Surge): 48A, 8/20 μ s - L3 (Line-Gnd), L4 (Line-Line) & L1 (Power)

FEATURES

- ✓ 15,000 Watts Peak Pulse Power per Line (tp=10/1000 μ s)
- ✓ Unidirectional & Bidirectional Configurations
- ✓ Easy Mounting to Printed Circuit Board
- ✓ Available in Multiple Voltage Types Ranging From: 17V to 220V
- ✓ RoHS Compliant in Lead-Free Versions (Exemption #7)

MECHANICAL CHARACTERISTICS

- ✓ Molded Case
- ✓ Weight 5 grams (Approximate)
- ✓ Flammability Rating UL 94V-0
- ✓ Available in Tin-Lead or Lead-Free Pure-Tin Plating(Annealed)
- ✓ Solder Reflow Temperature:
 - Tin-Lead - Sn/Pb, 85/15: 240-245°C
 - Pure-Tin - Sn, 100: 260-270°C
- ✓ Marking: Logo, Part Number & Date Code
- ✓ Positive Terminal Marked with Band - *Unidirectional Only*

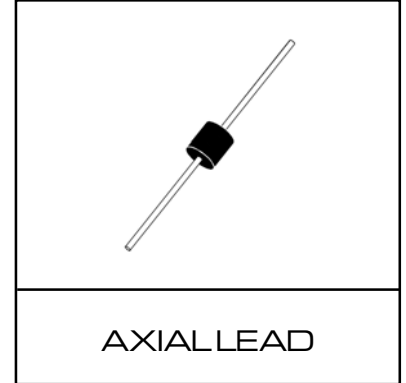

APPLICATION

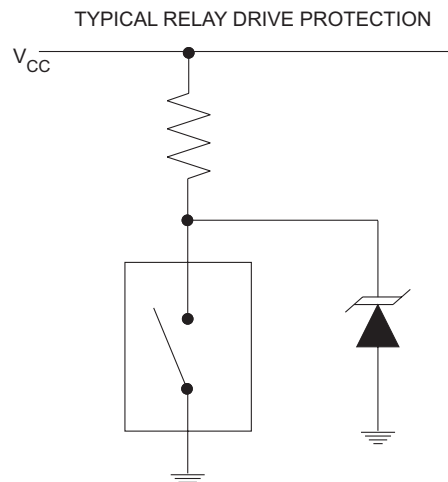

DEVICE CHARACTERISTICS

MAXIMUM RATINGS @ 25°C Unless Otherwise Specified			
PARAMETER	SYMBOL	VALUE	UNITS
Peak Pulse Power (tp =10/1000µs) - See Fig. 1	P _{PP}	15000	Watts
Forward Surge Rating (1/20 seconds) - See Note 2	I _F	200	Amps
Steady State Power Dissipation	P _D	1.0	Watts
Storage Temperature	T _{STG}	-55 to +150	°C
Operating Temperature	T _J	-55 to +150	°C

ELECTRICAL CHARACTERISTICS @ 25°C Unless Otherwise Specified						
PART NUMBER (Notes 1 & 2)	RATED STAND-OFF VOLTAGE V _{WM} VOLTS	BREAKDOWN VOLTAGE		MAXIMUM LEAKAGE CURRENT @V _{WM} I _D µA	MAXIMUM CLAMPING VOLTAGE (See Fig. 2) @ 10/1000µs V _C @ I _{PP}	TEMPERATURE COEFFICIENT OF V _(BR) qV _(BR) mV/°C
		MIN V _(BR) VOLTS	@I _T mA			
15KPA17	17.0	18.9	50	5000	32.3V @ 464.0A	19
15KPA17A	17.0	18.9	50	5000	29.3V @ 512.0A	17
15KPA18	18.0	20.0	50	5000	34.2V @ 439.0A	20
15KPA18A	18.0	20.0	50	5000	30.9V @ 485.0A	18
15KPA20	20.0	22.2	20	1500	37.9V @ 396.0A	24
15KPA20A	20.0	22.2	20	1500	34.3V @ 437.0A	21
15KPA22	22.0	24.4	10	500	41.1V @ 365.0A	27
15KPA22A	22.0	24.4	10	500	37.1V @ 404.0A	24
15KPA24	24.0	26.7	5	150	45.0V @ 333.0A	30
15KPA24A	24.0	26.7	5	150	40.7V @ 369.0A	27
15KPA26	26.0	28.9	5	50	48.7V @ 308.0A	32
15KPA26A	26.0	28.9	5	50	44.0V @ 341.0A	29
15KPA28	28.0	31.1	5	25	52.4V @ 286.0A	35
15KPA28A	28.0	31.1	5	25	47.5V @ 316.0A	31
15KPA30	30.0	33.3	5	15	56.2V @ 267.0A	27
15KPA30A	30.0	33.3	5	15	50.7V @ 296.0A	34
15KPA33	33.0	36.7	5	10	60.6V @ 248.0A	42
15KPA33A	33.0	36.7	5	10	54.8V @ 274.0A	38
15KPA36	36.0	40.0	5	10	66.0V @ 227.0A	46
15KPA36A	36.0	40.0	5	10	59.7V @ 251.0A	41
15KPA40	40.0	44.4	5	10	72.8V @ 206.0A	51
15KPA40A	40.0	44.4	5	10	65.8V @ 228.0A	46
15KPA43	43.0	47.8	5	10	77.1V @ 195.0A	55
15KPA43A	43.0	47.8	5	10	69.7V @ 215.0A	50
15KPA45	45.0	50.0	5	10	80.7V @ 186.0A	57
15KPA45A	45.0	50.0	5	10	73.0V @ 205.0A	52
15KPA48	48.0	53.3	5	10	85.9V @ 175.0A	62
15KPA48A	48.0	53.3	5	10	77.7V @ 193.0A	56
15KPA51	51.0	56.7	5	10	91.5V @ 164.0A	66
15KPA51A	51.0	56.7	5	10	82.8V @ 181.0A	60
15KPA54	54.0	60.0	5	10	96.8V @ 155.0A	70
15KPA54A	54.0	60.0	5	10	87.5V @ 171.0A	63
15KPA58	58.0	64.4	5	10	104.0V @ 144.0A	76
15KPA58A	58.0	64.4	5	10	94.0V @ 160.0A	68
15KPA60	60.0	66.7	5	10	107.0V @ 140.0A	78
15KPA60A	60.0	66.7	5	10	97.3V @ 154.0A	71
15KPA64	64.0	71.1	5	10	115.0V @ 130.0A	84
15KPA64A	64.0	71.1	5	10	104.0V @ 144.0A	76
15KPA70	70.0	77.8	5	10	126.0V @ 119.0A	92
15KPA70A	70.0	77.8	5	10	114.0V @ 132.0A	83

15KPA17A thru 15KPA280A

ELECTRICAL CHARACTERISTICS @ 25°C Unless Otherwise Specified

PART NUMBER (Notes 1 & 2)	RATED STAND-OFF VOLTAGE V_{WM} VOLTS	BREAKDOWN VOLTAGE		MAXIMUM LEAKAGE CURRENT I_D @ V_{WM} μA	MAXIMUM CLAMPING VOLTAGE (See Fig. 2) @ 10/1000 μs V_C @ I_{PP}	TEMPERATURE COEFFICIENT OF $V_{(BR)}$ $qV_{(BR)}$ mV/°C
		MIN $V_{(BR)}$ VOLTS	@ I_T mA			
15KPA75	75.0	83.3	5	10	135.0V @ 111.0A	100
15KPA75A	75.0	83.3	5	10	122.0V @ 123.0A	89
15KPA78	78.0	86.7	5	10	140.0V @ 107.0A	104
15KPA78A	78.0	86.7	5	10	126.0V @ 119.0A	93
15KPA85	85.0	94.4	5	10	152.0V @ 99.0A	113
15KPA85A	85.0	94.4	5	10	137.0V @ 109.0A	102
15KPA90	90.0	100.0	5	10	160.0V @ 94.0A	120
15KPA90A	90.0	100.0	5	10	146.0V @ 103.0A	109
15KPA100	100.0	111.0	5	10	179.0V @ 84.0A	134
15KPA100A	100.0	111.0	5	10	162.0V @ 93.0A	121
15KPA110	110.0	122.0	5	10	196.0V @ 77.0A	147
15KPA110A	110.0	122.0	5	10	178.0V @ 84.0A	133
15KPA120	120.0	133.0	5	10	214.0V @ 70.0A	161
15KPA120A	120.0	133.0	5	10	193.0V @ 78.0A	145
15KPA130	130.0	144.0	5	10	231.0V @ 65.0A	174
15KPA130A	130.0	144.0	5	10	209.0V @ 72.0A	157
15KPA150	150.0	167.0	5	10	268.0V @ 56.0A	202
15KPA150A	150.0	167.0	5	10	243.0V @ 62.0A	183
15KPA160	160.0	178.0	5	10	287.0V @ 52.0A	216
15KPA160A	160.0	178.0	5	10	259.0V @ 58.0A	195
15KPA170	170.0	189.0	5	10	304.0V @ 49.0A	229
15KPA170A	170.0	189.0	5	10	275.0V @ 55.0A	207
15KPA180	180.0	200.0	5	10	321.0V @ 47.0A	242
15KPA180A	180.0	200.0	5	10	291.0V @ 52.0A	219
15KPA200	200.0	222.0	5	10	356.0V @ 42.0A	269
15KPA200A	200.0	222.0	5	10	322.0V @ 47.0A	243
15KPA220	220.0	245.0	5	10	393.0V @ 38.0A	297
15KPA220A	220.0	245.0	5	10	356.0V @ 42.0A	269
15KPA240	240.0	267.0	5	10	428.0V @ 35.0A	324
15KPA240A	240.0	267.0	5	10	388.0V @ 39.0A	293
15KPA260	260.0	289.0	5	10	464.0V @ 32.0A	352
15KPA260A	260.0	289.0	5	10	419.0V @ 36.0A	317
15KPA280	280.0	311.0	5	10	500.0V @ 30.0A	378
15KPA280A	280.0	311.0	5	10	452.0V @ 33.0A	342

Note 1: Part numbers shown are unidirectional devices. Add a "CA" suffix to specify bidirectional devices, such as 15KPA20CA.

Note 2: $V_F = 7.5$ Volts @ 200A, 8.3ms (1/2 Sine Wave) - unidirectional devices only.

GRAPHS

FIGURE 1
PEAK PULSE POWER VS PULSE TIME

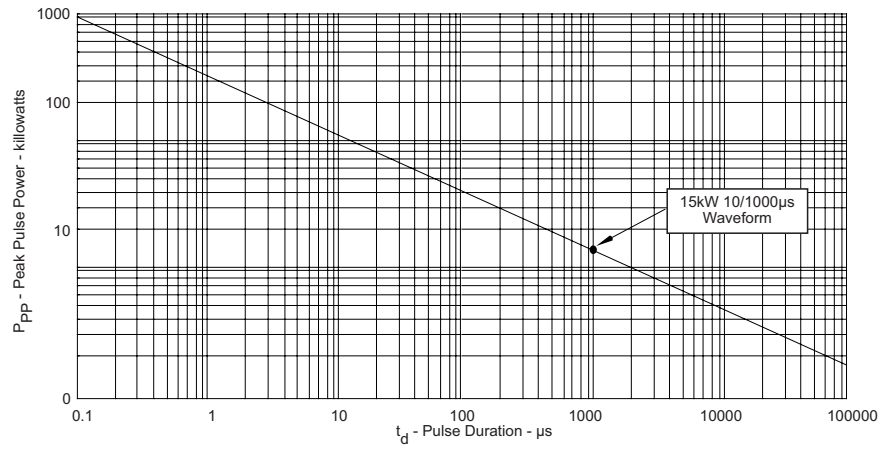

FIGURE 2
PULSE WAVE FORM

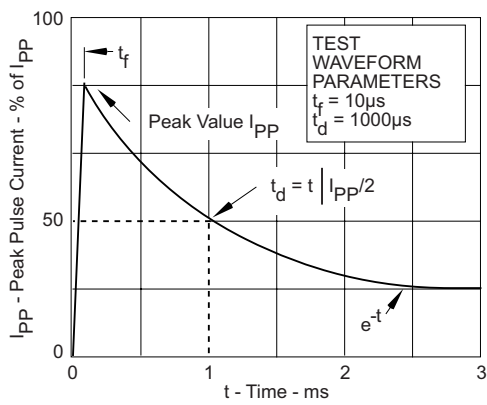
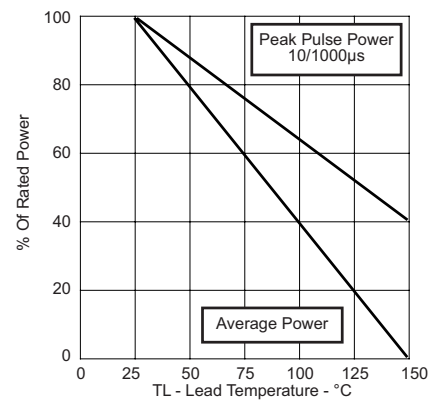
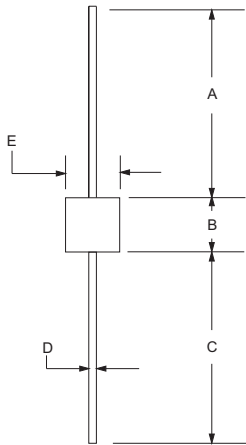
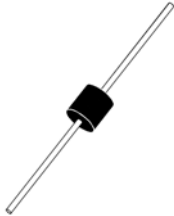

FIGURE 3
POWER DERATING CURVE



15KPA17A thru 15KPA280A

PACKAGE OUTLINE & DIMENSIONS

PACKAGE OUTLINE		AXIAL LEAD			
					
PACKAGE DIMENSIONS					
DIM	MILLIMETERS		INCHES		
	MIN	MAX	MIN	MAX	
A	24.5	-	1.00	-	
B	8.60	9.10	0.34	0.36	
C	24.5	-	1.00	-	
D	1.20 DIA	1.30 DIA	0.048 DIA	0.052 DIA	
E	8.60	9.10	0.34	0.36	
NOTES					
1. Dimensions are exclusive of mold flash and metal burrs. 2. Suffix - LF = Lead-Free, Pure-Tin Plating, i.e., 15KPA90A-LF.					
Outline & Dimensions: Rev 0 - 12/01, 06028					

COPYRIGHT © ProTek Devices 2005

SPECIFICATIONS: ProTek reserves the right to change the electrical and or mechanical characteristics described herein without notice (except JEDEC).

DESIGN CHANGES: ProTek reserves the right to discontinue product lines without notice, and that the final judgement concerning selection and specifications is the buyer's and that in furnishing engineering and technical assistance, ProTek assumes no responsibility with respect to the selection or specifications of such products.

ProTek Devices
 2929 South Fair Lane, Tempe, AZ 85282
 Tel: 602-431-8101 Fax: 602-431-2288
 E-Mail: sales@protekdevices.com
 Web Site: www.protekdevices.com