

MEDIUM VOLTAGE FUSES

2,400-38,000 VAC • Current-Limiting



Description

Littelfuse® offers a selection of E- and R-rated medium voltage fuses for the protection of transformers, potential transformers, feeders, and motor circuits. Single, double, and triple barrel designs are available to cover a wide range of current, voltage, and interrupting ratings. Conventional ferrule type, clip lock, and bolt-in mounting configurations are available for virtually any application. Hermetically sealed fuses for use in hazardous environments are also offered.

Contact the factory or your local Littelfuse representative for additional fuse ratings or custom mounting configurations.

24-Hour Emergency Service - Call 800-227-0029

Applications

- Power Transformer Protection
- Potential Transformer Protection
- Motor Controller Back-up Protection
- Fused Switches
- Feeder Circuits



Current-limiting E- and R-rated fuses are equipped with a mechanical indicator or striker pin that protrudes through the fuse cap upon operation of the fuse. This provides visual identification of a blown fuse and can be used as a trigger for external devices.

Note: Extension distance 1/2" minimum; extension force 2 lb. minimum.

General Information

The terms "Medium Voltage" and "High Voltage" have been used interchangeably by many people to describe fuses operating above 600 volts. Technically speaking, medium voltage fuses are those intended for the voltage range from 2,400 to 38,000 Vac. High voltage fuses are for circuits carrying voltages greater than 38,000 Vac.

E-rated fuses are considered to be general purpose fuses and can be used to protect against low and high values of fault current. R-rated fuses are designed for back-up protection. They must be used in series with other devices such as motor overload relays in order to achieve both overload and short-circuit protection.

Medium voltage fuses are not intended to provide overload protection in the same sense as fuses rated 600 volts or less. Medium voltage fuse current ratings do not have the same meanings as the ampere ratings of low voltage fuses.

All medium voltage fuses are limited in their ability to interrupt low value overcurrents, especially those between 100% and 200% of the fuse's continuous current rating. They are designed to carry their rated current without exceeding the temperature rise permitted by NEMA and ANSI standards.



Bolt-in Mount Fuses

R-RATED MEDIUM VOLTAGE FUSES

Description

R-rated fuses provide required short-circuit protection for medium voltage motors, motor controllers and associated circuitry. These components have limited ability to absorb the energy of large short-circuit currents. Medium voltage motor controllers contain overload relays which provide both overload protection and locked rotor protection to the motor. The controllers are also intended to interrupt low value short-circuits within the capability of the motor controller. This protects the medium voltage fuse from sustained overcurrents which are less than their minimum interrupting rating.

NEMA Standards for R-rated medium voltage power fuses require they operate within 15-35 seconds when subjected to an rms current 100 times the R rating. For example, a fuse with a 2R rating will open within 15 to 35 seconds on an applied current of $2 \times 100 = 200$ amperes.

Ordering Number

130-4R-1C-5.5

Max Voltage (KV)
Style:
C (Cartridge)
B (Bolt Mount)
IB (Inverted Bolt Mount)
BI (Bolt-In Mount)
No. of Barrels
Rating (size)
Continuous Current

Dimensions

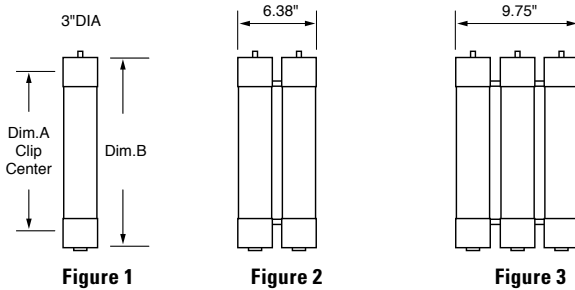

Cartridge "C"

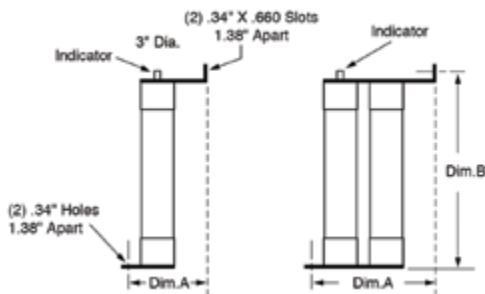

Bolt Mount "B"

Sample Part #: 130-4R-1B-5.5

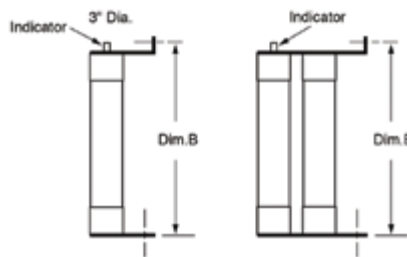

Inverted-Bolt "IB"

Sample Part #: 130-4R-1IB-5.5

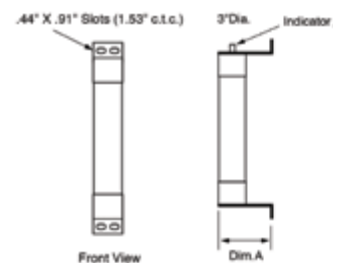

Bolt-In Mount "BI"

Sample Part #: 130-4R-1BI-5.5

Characteristics

Voltage Ratings 2,750 V – 8,250 V
Current Range 2R – 36R

Options

- Hermetically sealed for use in hazardous locations (add "S" suffix to part number)
- Bolt-in mounting configurations



Hookey Feature*

For hookey attachment; add "W" suffix to part number

*See web for Bolt Mount, Inverted Bolt Mount, and Bolt-In dimensions

Medium Voltage Fuse Protection

POWR-GARD® medium voltage fuses provide short-circuit protection for motors and transformers rated 2,400 to 38,000 volts AC.

Visit littelfuse.com/MediumVoltage to download the white paper featuring protection tables, sizing recommendations, and applications.



R-RATED MEDIUM VOLTAGE FUSES

R RATED	ORDERING/CATALOG NUMBER	SIZE	MAXIMUM CONTINUOUS CURRENT @ 40 DEGREES C°	DIM. A (INCHES)	DIM. B (INCHES)	MINIMUM INTERRUPTING RATING RMS AMPS	MAXIMUM INTERRUPTING RATING RMS (ASYM)*	FIGURE NUMBER
2.75 KV	702R1C2.75	2R	70	7"	10.875"	170	80,000	1
	1003R1C2.75	3R	100	7"	10.875"	250	80,000	1
	1304R1C2.75	4R	130	7"	10.875"	340	80,000	1
	1505R1C2.75	5R	150	7"	10.875"	390	80,000	1
	1706R1C2.75	6R	170	7"	10.875"	500	80,000	1
	2009R1C2.75	9R	200	7"	10.875"	760	80,000	1
	23012R1C2.75	12R	230	7"	10.875"	1000	80,000	1
	39018R2C2.75	18R	390	7"	10.875"	1500	80,000	2
45024R2C2.75	24R	450	7"	10.875"	1950	80,000	2	

R RATED	ORDERING/CATALOG NUMBER	SIZE	MAXIMUM CONTINUOUS CURRENT @ 40 DEGREES C°	DIM. A (INCHES)	DIM. B (INCHES)	MINIMUM INTERRUPTING RATING RMS AMPS	MAXIMUM INTERRUPTING RATING RMS (ASYM)*	FIGURE NUMBER
5.5 KV	702R1C5.5	2R	70	12"	15.875"	170	80,000	1
	1003R1C5.5	3R	100	12"	15.875"	250	80,000	1
	1304R1C5.5	4R	130	12"	15.875"	340	80,000	1
	1505R1C5.5	5R	150	12"	15.875"	390	80,000	1
	1706R1C5.5	6R	170	12"	15.875"	500	80,000	1
	2009R1C5.5	9R	200	12"	15.875"	760	80,000	1
	23012R1C5.5	12R	230	12"	15.875"	1000	80,000	1
	39018R2C5.5	18R	390	12"	15.875"	1500	80,000	2
	45024R2C5.5	24R	450	12"	15.875"	1950	80,000	2
	48026R2C5.5	26R	480	12"	15.875"	2100	80,000	2
	55030R2C5.5	30R	550	12"	15.875"	2400	80,000	2
	60032R2C5.5	32R	600	12"	15.875"	2600	80,000	2
	65036R2C5.5	36R	650	12"	15.875"	2900	80,000	2
	55030R3C5.5	30R	550	12"	15.875"	2400	80,000	3
	60032R3C5.5	32R	600	12"	15.875"	2600	80,000	3
65036R3C5.5	36R	650	12"	15.875"	2900	80,000	3	

R RATED	ORDERING/CATALOG NUMBER	SIZE	MAXIMUM CONTINUOUS CURRENT @ 40 DEGREES C°	DIM. A (INCHES)	DIM. B (INCHES)	MINIMUM INTERRUPTING RATING RMS AMPS	MAXIMUM INTERRUPTING RATING RMS (ASYM)*	FIGURE NUMBER
5.5 KV 14" CLIP CENTERS	702R1C5.5X	2R	70	14"	17.875"	170	80,000	1
	1003R1C5.5X	3R	100	14"	17.875"	250	80,000	1
	1304R1C5.5X	4R	130	14"	17.875"	340	80,000	1
	1505R1C5.5X	5R	150	14"	17.875"	390	80,000	1
	1706R1C5.5X	6R	170	14"	17.875"	500	80,000	1
	2009R1C5.5X	9R	200	14"	17.875"	760	80,000	1
	23012R1C5.5X	12R	230	14"	17.875"	1000	80,000	1
	39018R2C5.5X	18R	390	14"	17.875"	1500	80,000	2
	45024R2C5.5X	24R	450	14"	17.875"	1950	80,000	2
55030R2C5.5X	30R	550	14"	17.875"	2400	80,000	2	

R RATED	ORDERING/CATALOG NUMBER	SIZE	MAXIMUM CONTINUOUS CURRENT @ 40 DEGREES C°	DIM. A (INCHES)	DIM. B (INCHES)	MINIMUM INTERRUPTING RATING RMS AMPS	MAXIMUM INTERRUPTING RATING RMS (ASYM)*	FIGURE NUMBER
8.25 KV	702R1C8.25	2R	70	12"	15.875"	190	80,000	1
	1003R1C8.25	3R	100	12"	15.875"	225	80,000	1
	1304R1C8.25	4R	130	12"	15.875"	330	80,000	1
	1505R1C8.25	5R	150	12"	15.875"	440	80,000	1
	1706R1C8.25	6R	170	12"	15.875"	500	80,000	1
	2009R1C8.25	9R	200	12"	15.875"	740	80,000	1
	23012R1C8.25	12R	230	12"	15.875"	955	80,000	1
	39018R2C8.25	18R	390	12"	15.875"	1440	80,000	2
45024R2C8.25	24R	450	12"	15.875"	1910	80,000	2	

* RMS Asymmetrical amperes = RMS Symmetrical amperes x 1.6
For hookeye attachment add "W" suffix to part number

E-RATED MEDIUM VOLTAGE FUSES

Description

E-rated fuses have time current characteristics designed to provide current-limiting protection for power transformers, potential transformers, power centers, feeder centers, and unit sub stations. When properly applied, they can protect against high and low fault currents.

NEMA Standards for E-rated medium voltage fuses require that fuses rated 100E or less open within 300 seconds (5 minutes) when subjected to an RMS value of 200-240% of the fuse continuous current rating; and fuses with an E rating larger than 100E must open within 600 seconds (10 minutes) when subjected to an RMS current of 220-240% of the fuse's continuous current rating. These values establish one point on the time-current curve.

Application Note

Since these fuses are used for the protection of general purpose circuits which may contain transformers, motors, and other equipment producing in-rush and/or overload currents, fuses should generally be rated at 140% of the normal full load current, and circuits should be analyzed to ensure that system load currents will not exceed the current rating of the fuse.

Characteristics

Voltage Ratings 2,750 V – 38,000 V
Current Range 10E – 600E

Options

- Hermetically sealed for use in hazardous locations (add "S" suffix to part number)
- Clip-lock (CL) available.

Dimensions

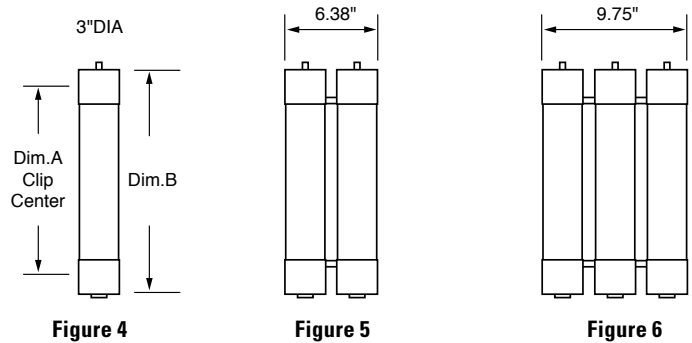

E-RATED	ORDERING/CATALOG NUMBER	SIZE	DIM. A (INCHES)	DIM. B (INCHES)	MAX INTERRUPTING RATING RMS (ASYM)*	FIGURE NUMBER
2.75 MAX. KV	10E1C2.75	10E	7"	10.875"	80,000	4
	15E1C2.75	15E	7"	10.875"	80,000	4
	20E1C2.75	20E	7"	10.875"	80,000	4
	25E1C2.75	25E	7"	10.875"	80,000	4
	30E1C2.75	30E	7"	10.875"	80,000	4
	40E1C2.75	40E	7"	10.875"	80,000	4
	50E1C2.75	50E	7"	10.875"	80,000	4
	65E1C2.75	65E	7"	10.875"	80,000	4
	80E1C2.75	80E	7"	10.875"	80,000	4
	100E-1C2.75	100E	7"	10.875"	80,000	4
	125E1C2.75	125E	7"	10.875"	80,000	4
	150E1C2.75	150E	7"	10.875"	80,000	4
	200E1C2.75	200E	7"	10.875"	80,000	4
	125E2C2.75	125E	7"	10.875"	80,000	5
	150E2C2.75	150E	7"	10.875"	80,000	5
	200E2C2.75	200E	7"	10.875"	80,000	5
	250E2C2.75	250E	7"	10.875"	80,000	5
	300E2C2.75	300E	7"	10.875"	80,000	5
	350E2C2.75	350E	7"	10.875"	80,000	5
	400E2C2.75	400E	7"	10.875"	80,000	5
450E2C2.75	450E	7"	10.875"	80,000	5	

* RMS Asymmetrical amperes = RMS Symmetrical amperes x 1.6

E-RATED MEDIUM VOLTAGE FUSES

E-RATED	ORDERING/CATALOG NUMBER	SIZE	DIM. A (INCHES)	DIM. B (INCHES)	MAX INTERRUPTING RATING RMS (ASYM)*	FIGURE NUMBER
5.5 MAX. KV	10E1C5.5	10E	12"	15.875"	80,000	4
	15E1C5.5	15E	12"	15.875"	80,000	4
	20E1C5.5	20E	12"	15.875"	80,000	4
	25E1C5.5	25E	12"	15.875"	80,000	4
	30E1C5.5	30E	12"	15.875"	80,000	4
	40E1C5.5	40E	12"	15.875"	80,000	4
	50E1C5.5	50E	12"	15.875"	80,000	4
	65E1C5.5	65E	12"	15.875"	80,000	4
	80E1C5.5	80E	12"	15.875"	80,000	4
	100E1C5.5	100E	12"	15.875"	80,000	4
	125E1C5.5	125E	12"	15.875"	80,000	4
	150E1C5.5	150E	12"	15.875"	80,000	4
	175E1C5.5	175E	12"	15.875"	80,000	4
	200E1C5.5	200E	12"	15.875"	80,000	4
	125E2C5.5	125E	12"	15.875"	80,000	5
	150E2C5.5	150E	12"	15.875"	80,000	5
	175E2C5.5	175E	12"	15.875"	80,000	5
	200E2C5.5	200E	12"	15.875"	80,000	5
	250E2C5.5	250E	12"	15.875"	80,000	5
	300E2C5.5	300E	12"	15.875"	80,000	5
	350E2C5.5	350E	12"	15.875"	80,000	5
	400E2C5.5	400E	12"	15.875"	80,000	5
	450E2C5.5	450E	12"	15.875"	80,000	5
	500E3C5.5	500E	12"	15.875"	80,000	6
	550E3C5.5	550E	12"	15.875"	80,000	6
	600E3C5.5	600E	12"	15.875"	80,000	6

E-RATED	ORDERING/CATALOG NUMBER	SIZE	DIM. A (INCHES)	DIM. B (INCHES)	MAX INTERRUPTING RATING RMS (ASYM)*	FIGURE NUMBER
5.5 MAX. KV	5NLE10E	10E	14"	17 $\frac{7}{8}$ "	80,000	4
	5NLE15E	15E	14"	17 $\frac{7}{8}$ "	80,000	4
	5NLE20E	20E	14"	17 $\frac{7}{8}$ "	80,000	4
	5NLE25E	25E	14"	17 $\frac{7}{8}$ "	80,000	4
	5NLE30E	30E	14"	17 $\frac{7}{8}$ "	80,000	4
	5NLE40E	40E	14"	17 $\frac{7}{8}$ "	80,000	4
	5NLE50E	50E	14"	17 $\frac{7}{8}$ "	80,000	4
	5NLE65E	65E	14"	17 $\frac{7}{8}$ "	80,000	4
	5NLE80E	80E	14"	17 $\frac{7}{8}$ "	80,000	4
	5NLE100E	100E	14"	17 $\frac{7}{8}$ "	80,000	4
	5NLE125E	125E	14"	17 $\frac{7}{8}$ "	80,000	4
	5NLE150E	150E	14"	17 $\frac{7}{8}$ "	80,000	4
	5NLE175E	175E	14"	17 $\frac{7}{8}$ "	80,000	4
	5NLE200E	200E	14"	17 $\frac{7}{8}$ "	80,000	4
	5NLE2225E	225E	14"	17 $\frac{7}{8}$ "	80,000	5
	5NLE2250E	250E	14"	17 $\frac{7}{8}$ "	80,000	5
	5NLE2300E	300E	14"	17 $\frac{7}{8}$ "	80,000	5
	5NLE2350E	350E	14"	17 $\frac{7}{8}$ "	80,000	5
	5NLE2400E	400E	14"	17 $\frac{7}{8}$ "	80,000	5
	5NLE2450E	450E	14"	17 $\frac{7}{8}$ "	80,000	5

* RMS Asymmetrical amperes = RMS Symmetrical amperes x 1.6

E-RATED MEDIUM VOLTAGE FUSES

E-RATED	ORDERING/CATALOG NUMBER	SIZE	DIM. A (INCHES)	DIM. B (INCHES)	MAX INTERRUPTING RATING RMS (ASYM)*	FIGURE NUMBER
8.25 MAX. KV	10E1C8.25	10E	12"	15 ⁷ / ₈ "	80,000	4
	15E1C8.25	15E	12"	15 ⁷ / ₈ "	80,000	4
	20E1C8.25	20E	12"	15 ⁷ / ₈ "	80,000	4
	25E1C8.25	25E	12"	15 ⁷ / ₈ "	80,000	4
	30E1C8.25	30E	12"	15 ⁷ / ₈ "	80,000	4
	40E1C8.25	40E	12"	15 ⁷ / ₈ "	80,000	4
	50E1C8.25	50E	12"	15 ⁷ / ₈ "	80,000	4
	65E1C8.25	65E	12"	15 ⁷ / ₈ "	80,000	4
	80E1C8.25	80E	12"	15 ⁷ / ₈ "	80,000	4
	100E1C8.25	100E	12"	15 ⁷ / ₈ "	80,000	4
	125E1C8.25	125E	12"	15 ⁷ / ₈ "	80,000	4
	150E1C8.25	150E	12"	15 ⁷ / ₈ "	80,000	4
	125E2C8.25	125E	12"	15 ⁷ / ₈ "	80,000	5
	150E2C8.25	150E	12"	15 ⁷ / ₈ "	80,000	5
	200E2C8.25	200E	12"	15 ⁷ / ₈ "	80,000	5
	250E2C8.25	250E	12"	15 ⁷ / ₈ "	80,000	5
	300E2C8.25	300E	12"	15 ⁷ / ₈ "	80,000	5
	350E3C8.25	350E	12"	15 ⁷ / ₈ "	80,000	6
400E3C8.25	400E	12"	15 ⁷ / ₈ "	80,000	6	

E-RATED	ORDERING/CATALOG NUMBER	SIZE	DIM. A (INCHES)	DIM. B (INCHES)	MAX INTERRUPTING RATING RMS (ASYM)*	FIGURE NUMBER
8.25 MAX. KV	8NLE10E	10E	14"	17 ⁷ / ₈ "	80,000	4
	8NLE15E	15E	14"	17 ⁷ / ₈ "	80,000	4
	8NLE20E	20E	14"	17 ⁷ / ₈ "	80,000	4
	8NLE25E	25E	14"	17 ⁷ / ₈ "	80,000	4
	8NLE30E	30E	14"	17 ⁷ / ₈ "	80,000	4
	8NLE40E	40E	14"	17 ⁷ / ₈ "	80,000	4
	8NLE50E	50E	14"	17 ⁷ / ₈ "	80,000	4
	8NLE65E	65E	14"	17 ⁷ / ₈ "	80,000	4
	8NLE80E	80E	14"	17 ⁷ / ₈ "	80,000	4
	8NLE100E	100E	14"	17 ⁷ / ₈ "	80,000	4
	8NLE2100E	100E	14"	17 ⁷ / ₈ "	80,000	5
	8NLE2125E	125E	14"	17 ⁷ / ₈ "	80,000	5
	8NLE2150E	150E	14"	17 ⁷ / ₈ "	80,000	5
	8NLE2200E	200E	14"	17 ⁷ / ₈ "	80,000	5
8NLE2250E	250E	14"	17 ⁷ / ₈ "	80,000	5	

E-RATED	ORDERING/CATALOG NUMBER	SIZE	DIM. A (INCHES)	DIM. B (INCHES)	MAX INTERRUPTING RATING RMS (ASYM)*	FIGURE NUMBER
15.5 MAX. KV	10E1C15.5	10E	15"	18.875"	80,000	4
	15E1C15.5	15E	15"	18.875"	80,000	4
	20E1C15.5	20E	15"	18.875"	80,000	4
	25E1C15.5	25E	15"	18.875"	80,000	4
	30E1C15.5	30E	15"	18.875"	80,000	4
	40E1C15.5	40E	15"	18.875"	80,000	4
	50E1C15.5	50E	15"	18.875"	80,000	4
	65E1C15.5	65E	15"	18.875"	80,000	4
	80E1C15.5	80E	15"	18.875"	80,000	4
	100E1C15.5	100E	15"	18.875"	80,000	4
	65E2C15.5	65E	15"	18.875"	80,000	5
	80E2C15.5	80E	15"	18.875"	80,000	5
	100E2C15.5	100E	15"	18.875"	80,000	5
	125E2C15.5	125E	15"	18.875"	80,000	5
	150E2C15.5	150E	15"	18.875"	80,000	5
	175E2C15.5	175E	15"	18.875"	80,000	5
	200E2C15.5	200E	15"	18.875"	80,000	5
	200E3C15.5	200E	15"	18.875"	80,000	6
	250E3C15.5	250E	15"	18.875"	80,000	6
	300E3C15.5	300E	15"	18.875"	80,000	6

* RMS Asymmetrical amperes = RMS Symmetrical amperes x 1.6

E-RATED MEDIUM VOLTAGE FUSES

E-RATED	ORDERING/CATALOG NUMBER	SIZE	DIM. A (INCHES)	DIM. B (INCHES)	MAX INTERRUPTING RATING RMS (ASYM)*	FIGURE NUMBER
15.5 MAX. KV	15GSE65E	65E	18"	21 ⁷ / ₈ "	60,000	4
	15GSE80E	80E	18"	21 ⁷ / ₈ "	60,000	4
	15GSE100E	100E	18"	21 ⁷ / ₈ "	60,000	4
	15GSE2125E	125E	18"	21 ⁷ / ₈ "	60,000	5
	15GSE2150E	150E	18"	21 ⁷ / ₈ "	60,000	5
	15GSE2175E	175E	18"	21 ⁷ / ₈ "	60,000	5
	15GSE2200E	200E	18"	21 ⁷ / ₈ "	60,000	5

E-RATED	ORDERING/CATALOG NUMBER	SIZE	DIM. A (INCHES)	DIM. B (INCHES)	MAX INTERRUPTING RATING RMS (ASYM)*	FIGURE NUMBER
15.5 MAX. KV	15NLE10E	10E	20"	23 ⁷ / ₈ "	60,000	4
	15NLE15E	15E	20"	23 ⁷ / ₈ "	60,000	4
	15NLE20E	20E	20"	23 ⁷ / ₈ "	60,000	4
	15NLE25E	25E	20"	23 ⁷ / ₈ "	60,000	4
	15NLE30E	30E	20"	23 ⁷ / ₈ "	60,000	4
	15NLE40E	40E	20"	23 ⁷ / ₈ "	60,000	4
	15NLE50E	50E	20"	23 ⁷ / ₈ "	60,000	4
	15NLE65E	65E	20"	23 ⁷ / ₈ "	60,000	4
	15NLE80E	80E	20"	23 ⁷ / ₈ "	60,000	4
	15NLE100E	100E	20"	23 ⁷ / ₈ "	60,000	4
	15NLE280E	80E	20"	23 ⁷ / ₈ "	60,000	5
	15NLE2100E	100E	20"	23 ⁷ / ₈ "	60,000	5
	15NLE2125E	125E	20"	23 ⁷ / ₈ "	60,000	5
	15NLE2150E	150E	20"	23 ⁷ / ₈ "	60,000	5
	15NLE2175E	175E	20"	23 ⁷ / ₈ "	60,000	5
	15NLE2200E	200E	20"	23 ⁷ / ₈ "	60,000	5
	15NLE3150E	150E	20"	23 ⁷ / ₈ "	60,000	6
	15NLE3175E	175E	20"	23 ⁷ / ₈ "	60,000	6
15NLE3250E	250E	20"	23 ⁷ / ₈ "	60,000	6	
15NLE3300E	300E	20"	23 ⁷ / ₈ "	60,000	6	

E-RATED	ORDERING/CATALOG NUMBER	SIZE	DIM. A (INCHES)	DIM. B (INCHES)	MAX INTERRUPTING RATING RMS (ASYM)*	FIGURE NUMBER
25.8 MAX. KV	15E1C25.8	15E	21"	24 ⁷ / ₈ "	40,000	4
	20E1C25.8	20E	21"	24 ⁷ / ₈ "	40,000	4
	25E1C25.8	25E	21"	24 ⁷ / ₈ "	40,000	4
	30E1C25.8	30E	21"	24 ⁷ / ₈ "	40,000	4
	40E1C25.8	40E	21"	24 ⁷ / ₈ "	40,000	4
	50E1C25.8	50E	21"	24 ⁷ / ₈ "	40,000	4
	65E2C25.8	65E	21"	24 ⁷ / ₈ "	40,000	5
	80E2C25.8	80E	21"	24 ⁷ / ₈ "	40,000	5
	100E2C25.8	100E	21"	24 ⁷ / ₈ "	40,000	5

E-RATED	ORDERING/CATALOG NUMBER	SIZE	DIM. A (INCHES)	DIM. B (INCHES)	MAX INTERRUPTING RATING RMS (ASYM)*	FIGURE NUMBER
38 MAX. KV	3E1C38.0	3E	27"	30 ⁷ / ₈ "	20,000	4
	7E1C38.0	7E	27"	30 ⁷ / ₈ "	20,000	4
	10E1C38.0	10E	27"	30 ⁷ / ₈ "	20,000	4
	15E1C38.0	15E	27"	30 ⁷ / ₈ "	20,000	4
	20E1C38.0	20E	27"	30 ⁷ / ₈ "	20,000	4
	25E1C38.0	25E	27"	30 ⁷ / ₈ "	20,000	4
	30E1C38.0	30E	27"	30 ⁷ / ₈ "	20,000	4
	40E1C38.0	40E	27"	30 ⁷ / ₈ "	20,000	4
	50E2C38.0	50E	27"	30 ⁷ / ₈ "	20,000	5
	65E2C38.0	65E	27"	30 ⁷ / ₈ "	20,000	5
	80E2C38.0	80E	27"	30 ⁷ / ₈ "	20,000	5

* RMS Asymmetrical amperes = RMS Symmetrical amperes x 1.6

E-RATED MEDIUM VOLTAGE FUSES

Clip Lock Design

The clip lock type designs ensures a positive contact between the fuse and the connection cam. The fuse's clip lock tab slides in between the clip casting and the cam to prevent the fuse from slipping or blowing out of the holder. This positive contact improves heat dissipation and allows fuses to run cooler.

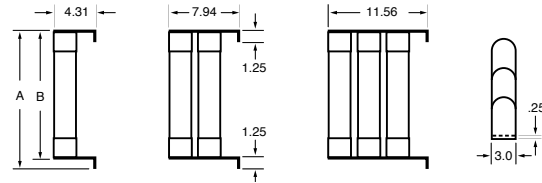

Figure 7

Figure 8

Figure 9

Dimensions in inches

E-RATED	ORDERING/CATALOG NUMBER	SIZE	DIM. A (INCHES)	DIM. B (INCHES)	MAX INTERRUPTING RATING RMS (ASYM)*	FIGURE NUMBER	
5.5 MAX. KV CLIP LOCK	10E1CL5.5	10E	16.38"	15.13"	80,000	7	
	15E1CL5.5	15E	16.38"	15.13"	80,000	7	
	20E1C5.5	20E	16.38"	15.13"	80,000	7	
	25E1CL5.5	25E	16.38"	15.13"	80,000	7	
	30E1CL5.5	30E	16.38"	15.13"	80,000	7	
	40E1CL5.5	40E	16.38"	15.13"	80,000	7	
	50E1CL5.5	50E	16.38"	15.13"	80,000	7	
	65E1CL5.5	65E	16.38"	15.13"	80,000	7	
	80E1CL5.5	80E	16.38"	15.13"	80,000	7	
	100E1CL5.5	100E	16.38"	15.13"	80,000	7	
	125E1CL5.5	125E	16.38"	15.13"	80,000	7	
	150E1CL5.5	150E	16.38"	15.13"	80,000	7	
	225E2CL5.5	225E	17.38"	16.13"	80,000	8	
	250E2CL5.5	250E	17.38"	16.13"	80,000	8	
	300E2CL5.5	300E	17.38"	16.13"	80,000	8	
	350E2CL5.5	350E	17.38"	16.13"	80,000	8	
	400E2CL5.5	400E	17.38"	16.13"	80,000	8	
	450E2CL5.5	450E	17.38"	16.13"	80,000	8	
	500E3CL5.5	500E	17.38"	16.13"	80,000	9	
	550E3CL5.5	550E	17.38"	16.13"	80,000	9	
600E3CL5.5	600E	17.38"	16.13"	80,000	9		
8.25 MAX. KV CLIP LOCK	10E1CL8.25	10E	17.38"	16.13"	80,000	7	
	15E1CL8.25	15E	17.38"	16.13"	80,000	7	
	20E1C8.25	20E	17.38"	16.13"	80,000	7	
	25E1CL8.25	25E	17.38"	16.13"	80,000	7	
	30E1CL8.25	30E	17.38"	16.13"	80,000	7	
	40E1CL8.25	40E	17.38"	16.13"	80,000	7	
	50E1CL8.25	50E	17.38"	16.13"	80,000	7	
	65E1CL8.25	65E	17.38"	16.13"	80,000	7	
	80E1CL8.25	80E	17.38"	16.13"	80,000	7	
	100E1CL8.25	100E	17.38"	16.13"	80,000	7	
	125E2CL8.25	125E	17.38"	16.13"	80,000	8	
	150E2CL8.25	150E	17.38"	16.13"	80,000	8	
	175E2CL8.25	175E	17.38"	16.13"	80,000	8	
	200E2CL8.25	200E	17.38"	16.13"	80,000	8	
	225E2CL8.25	225E	17.38"	16.13"	80,000	8	
	250E2CL8.25	250E	17.38"	16.13"	80,000	8	
	300E2CL8.25	300E	17.38"	16.13"	80,000	8	
	350E3CL8.25	350E	17.38"	16.13"	80,000	9	
	15.5 MAX. KV CLIP LOCK	10E1CL15.5	10E	19.8"	18.1"	60,000	7
		15E1CL15.5	15E	19.8"	18.1"	60,000	7
20E1CL15.5		20E	19.8"	18.1"	60,000	7	
25E1CL15.5		25E	19.8"	18.1"	60,000	7	
30E1CL15.5		30E	19.8"	18.1"	60,000	7	
40E1CL15.5		40E	19.8"	18.1"	60,000	7	
50E1CL15.5		50E	19.8"	18.1"	60,000	7	
65E1CL15.5		65E	22.81"	21.13"	60,000	7	
80E1CL15.5		80E	22.81"	21.13"	60,000	7	
100E1CL15.5		100E	22.81"	21.13"	60,000	7	
125E2CL15.5		125E	22.81"	21.13"	60,000	8	
150E2CL15.5		150E	22.81"	21.13"	60,000	8	
175E2CL15.5		175E	22.81"	21.13"	60,000	8	
200E2CL15.5		200E	22.81"	21.13"	60,000	8	
150E3CL15.5		150E	22.81"	21.13"	60,000	9	
200E3CL15.5		200E	22.81"	21.13"	60,000	9	
250E3CL15.5		250E	22.81"	21.13"	60,000	9	
300E3CL15.5		300E	22.81"	21.13"	60,000	9	

* RMS Asymmetrical amperes = RMS Symmetrical amperes x 1.6

E-RATED POTENTIAL TRANSFORMER FUSES

Description

Potential Transformer (PT) fuses are current-limiting fuses with high interrupting ratings designed for the protection of potential transformers.

Application Note

When applying fuses for the protection of transformers, the magnetizing current in-rush must be considered. The characteristics of the in-rush, which can be matched with a fuse time-current curve, should be available from the transformer manufacturer.

Characteristics

Voltage Ratings 625 Vac – 25,800 Vac
Current Range ½E – 10E

Dimensions

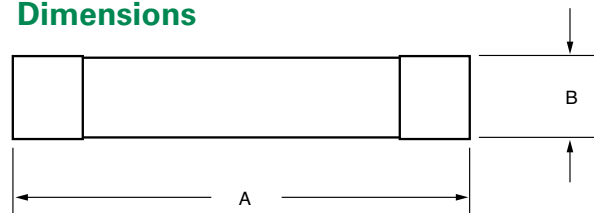

E-RATED	ORDERING/CATALOG NUMBER	SIZE	LENGTH DIM. A (INCHES)	DIAMETER DIM. B (INCHES)	MAX INTERRUPTING RATING RMS (ASYM)*
625 VOLT	3E4PT.6	3E	4.6"	0.8125"	37,500
	5E4PT.6	5E	4.6"	0.8125"	37,500
	7E4PT.6	7E	4.6"	0.8125"	37,500
	10E4PT.6	10E	4.6"	0.8125"	37,500
2.75 MAX. KV	500E4PT2.4	½E	4.6"	0.8125"	37,500
	1E4PT2.4	1E	4.6"	0.8125"	37,500
	2E4PT2.4	2E	4.6"	0.8125"	37,500
2.75 MAX. KV	1E6PT2.75	1E	7.4"	1.5625"	37,500
	2E6PT2.75	2E	7.4"	1.5625"	37,500
	3E6PT2.75	3E	7.4"	1.5625"	37,500
	1E8PT2.75	1E	9.5"	1.5625"	37,500
	2E8PT2.75	2E	9.5"	1.5625"	37,500
	3E8PT2.75	3E	9.5"	1.5625"	37,500
4.8 MAX. KV	1E5PT4.8	1E	5.6"	0.8125"	50,000
	2E5PT4.8	2E	5.6"	0.8125"	50,000
5.5 MAX. KV	500E6PT5.5	½E	7.4"	1.5625"	50,000
	1E6PT5.5	1E	7.4"	1.5625"	50,000
	2E6PT5.5	2E	7.4"	1.5625"	50,000
	3E6PT5.5	3E	7.4"	1.5625"	50,000
	5E6PT5.5	5E	7.4"	1.5625"	50,000
	500E8PT5.5	½E	9.5"	1.5625"	50,000
	1E8PT5.5	1E	9.5"	1.5625"	50,000
	2E8PT5.5	2E	9.5"	1.5625"	50,000
	3E8PT5.5	3E	9.5"	1.5625"	50,000
	5E8PT5.5	5E	9.5"	1.5625"	50,000
8.25 MAX. KV	10E8PT5.5	10E	9.5"	1.5625"	50,000
	500E8PT8.25	½E	9.5"	1.5625"	50,000
	1E8PT8.25	1E	9.5"	1.5625"	50,000
	2E8PT8.25	2E	9.5"	1.5625"	50,000
15.5 MAX. KV	3E8PT8.25	3	9.5"	1.5625"	50,000
	500E11PT15.5	½E	12.8"	1.5625"	35,000
	1E11PT15.5	1E	12.8"	1.5625"	35,000
	2E11PT15.5	2E	12.8"	1.5625"	35,000
	3E11PT15.5	3E	12.8"	1.5625"	35,000
	3E16PT15.5	3E	17.5"	1.5625"	35,000
25.8 MAX. KV	5E16PT15.5	5E	17.5"	1.5625"	35,000
	500E16PT25.5	½E	17.5"	1.5625"	32,000
	1E16PT25.5	1E	17.5"	1.5625"	32,000

* RMS Asymmetrical amperes = RMS Symmetrical amperes x 1.6

LIVE PARTS



Description

Live parts are available for mounting E, R, and PT single, double, and triple barrel fuses. Mounting clips are available for ferrule type and clip lock style fuses. All clips are sold in pairs.

Part Number 700-156 Ordering Number 0700156.Z

For use with 1⁹/₁₆" (1.5625") to 1⁵/₈" (1.625") diameter PT fuses.

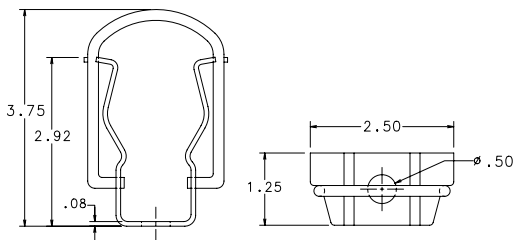

Dimensions in inches

Part Number 700-300 Ordering Number 0700300.Z

For use with 3" diameter fuses.

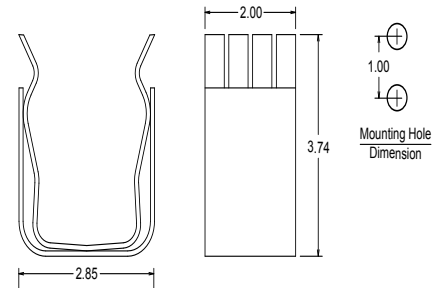

Part Number 700-500 Ordering Number 0700500.Z

For use with all 1³/₁₆" (.8125") diameter PT fuses

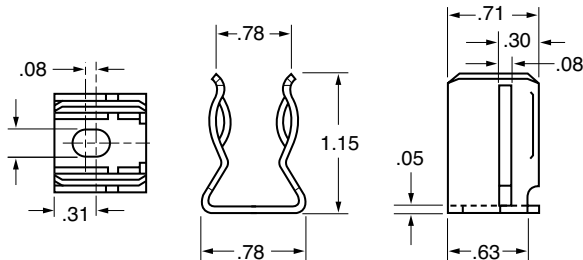

Dimensions in inches

Part Number 700-530 Ordering Number 0700530.Z

For use with all 3" diameter fuses.

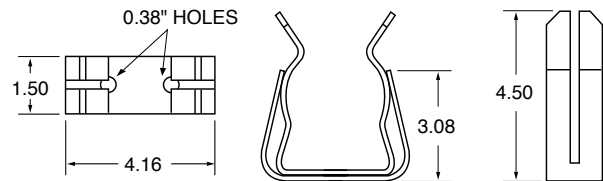

Part Number 700-520-CL Ordering Number 0700520.ZXCL

Clip Lock Design

Mounting Details for Clip Lock

CATALOG NUMBER	DIMENSION A (INCHES)
10E1CL5.5 thru 150E1CL5.5	12.88
225E2CL5.5 thru 600E3CL5.5	13.88
10E1CL8.25 thru 350E3CL8.25	13.88
10E1CL15.5 thru 50E1CL15.5	16.25
65E1CL15.5 thru 300E3CL15.5	19.25

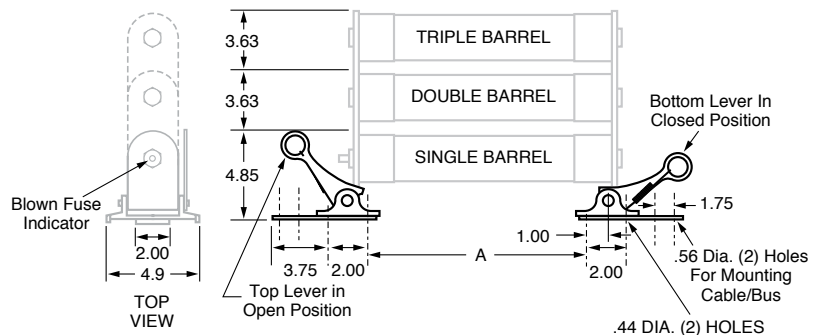
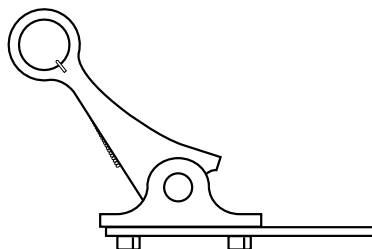

Dimensions for reference only.