

Standard SCRs, 16A

Main Features

Symbol	Value	Unit
$I_{T(RMS)}$	16	A
V_{DRM}/V_{RRM}	600 to 1000	V
I_{GT}	25	mA

DESCRIPTION

The 16PT series of silicon controlled rectifiers are high performance glass passivated technology, and are suitable for general purpose applications.

Using clip assembly technology, they provide a superior performance in surge current capabilities.

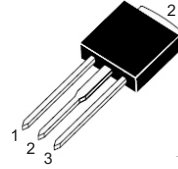

TO-251 (I-PAK)
(16PTxxF)

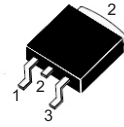

TO-252 (D-PAK)
(16PTxxG)

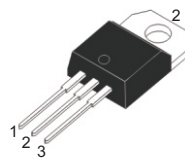

TO-220AB (Non-Insulated)
(16PTxxA)

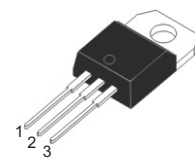

TO-220AB (Insulated)
(16PTxxAI)

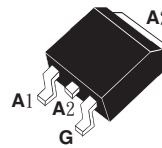

TO-263 (D²PAK)
(16PTxxH)

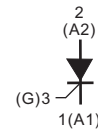

ABSOLUTE MAXIMUM RATINGS

PARAMETER	SYMBOL	TEST CONDITIONS		VALUE	UNIT
RMS on-state current full sine wave (180° conduction angle)	$I_{T(RMS)}$	TO-251/TO-252 TO-220AB/TO-263	$T_c = 110^\circ\text{C}$	16	A
		TO-220AB insulated	$T_c = 86^\circ\text{C}$		
Average on-state current (180° conduction angle)	$I_{T(AV)}$	TO-251/TO-252 TO-220AB/TO-263	$T_c = 110^\circ\text{C}$	10	A
		TO-220AB insulated	$T_c = 86^\circ\text{C}$		
Non repetitive surge peak on-state current (full cycle, T_j initial = 25°C)	I_{TSM}	F = 50 Hz	t = 20 ms	190	A
		F = 60 Hz	t = 16.7 ms	200	
I ² t Value for fusing	I ² t	$t_p = 10$ ms		180	A ² s
Critical rate of rise of on-state current $I_G = 2 \times I_{GT}$, $t_r \leq 100$ ns	di/dt	F = 60 Hz	$T_j = 125^\circ\text{C}$	50	A/ μ s
Peak gate current	I_{GM}	$T_p = 20$ μ s	$T_j = 125^\circ\text{C}$	4	A
Maximum gate power	P_{GM}	$T_p = 20$ μ s	$T_j = 125^\circ\text{C}$	10	W
Average gate power dissipation	$P_{G(AV)}$	$T_j = 125^\circ\text{C}$		1	W
Repetitive peak off-state voltage	V_{DRM}	$T_j = 125^\circ\text{C}$		600 to 1000	V
Repetitive peak reverse voltage	V_{RRM}				
Storage temperature range	T_{stg}			- 40 to + 150	°C
Operating junction temperature range	T_j			- 40 to + 125	

ELECTRICAL SPECIFICATIONS (T _J = 25 °C unless otherwise specified)						
SYMBOL	TEST CONDITIONS			16PTxxxx	Unit	
I _{GT}	V _D = 12V, R _L = 33Ω			Min.	2	mA
V _{GT}				Max.	15	
				Max.	1.3	V
V _{GD}	V _D = V _{DRM} , R _L = 3.3KΩ R _{GK} = 220Ω	T _J = 125°C	Min.	0.2	V	
I _H	I _T = 500mA, Gate open			Max.	40	mA
I _L	I _G = 1.2×I _{GT}			Min.	60	mA
dV/dt	V _D = 67% V _{DRM} , Gate open	T _J = 125°C	Min.	500	V/μs	
V _{TM}	I _T = 32A, t _p = 380μs		T _J = 25°C	Max.	1.6	V
I _{DRM} I _{RRM}	V _D = V _{DRM} , V _R = V _{RRM} R _{GK} = 220Ω		T _J = 25°C	Max.	5	μA
			T _J = 125°C	Max.	2	mA
V _{to}	Threshold Voltage		T _J = 125°C	Max.	0.77	V
R _d	Dynamic Resistance		T _J = 125°C	Max.	23	mΩ

THERMAL RESISTANCE						
SYMBOL	Parameter			VALUE	UNIT	
R _{th(j-c)}	Junction to case (DC)			IPAK/DPAK/TO-220AB/TO-263	1.1	°C/W
R _{th(j-a)}	Junction to ambient	S = 1 cm ²	TO-263(D ² PAK)	45	°C/W	
		S = 0.5 cm ²	TO-252(D-PAK)	70		
			TO-220AB	60		
			TO-251(I-PAK)	100		

S=Copper surface under tab

PRODUCT SELECTOR					
PART NUMBER	VOLTAGE (xx)			SENSITIVITY	PACKAGE
	600 V	800 V	1000 V		
16PTxxA/16PTxxAI	V	V	V	25 mA	TO-220AB
16PTxxF	V	V	V	25 mA	I-PAK
16PTxxG	V	V	V	25 mA	D-PAK
16PTxxH	V	V	V	25 mA	D ² PAK

ORDERING INFORMATION					
ORDERING TYPE	MARKING	PACKAGE	WEIGHT	BASE Q'TY	DELIVERY MODE
16PTxxA	16PTxxA	TO-220AB	2.0g	50	Tube
16PTxxAI	16PTxxAI	TO-220AB (insulated)	2.3g	50	Tube
16PTxxF	16PTxxF	TO-251(I-PAK)	0.40g	80	Tube
16PTxxG	16PTxxG	TO-252(D-PAK)	0.38g	80	Tube
16PTxxH	16PTxxH	TO-263(D ² PAK)	2.0g	50	Tube

Note: xx = voltage

ORDERING INFORMATION SCHEME

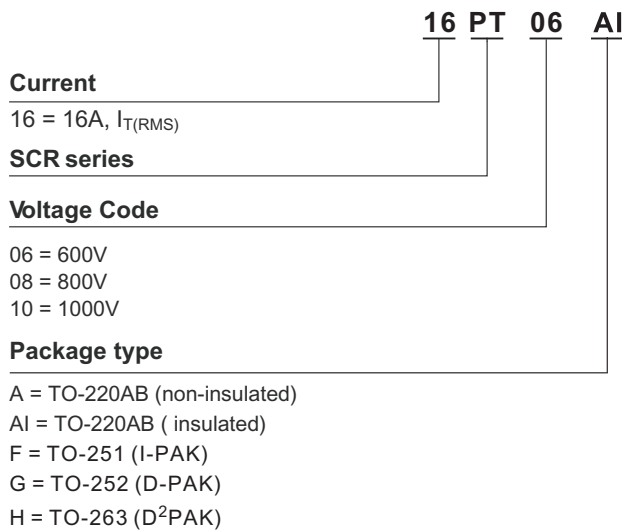

Fig.1 Maximum average power dissipation versus average on-state current.

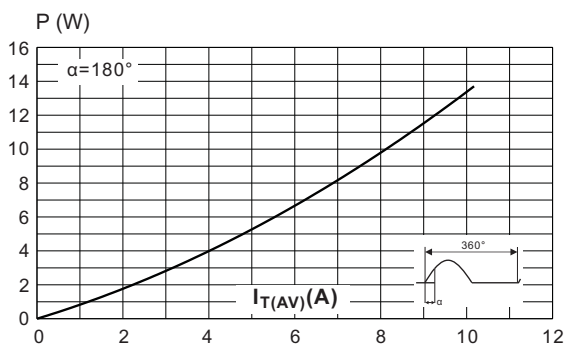

Fig.2 Average and D.C. on-state current versus case temperature.

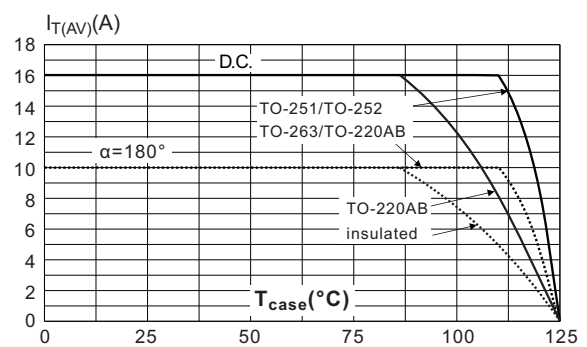

Fig.3 Average and D.C. on-state current versus ambient temperature. (copper surface under tab: S=1cm²) (D²PAK)

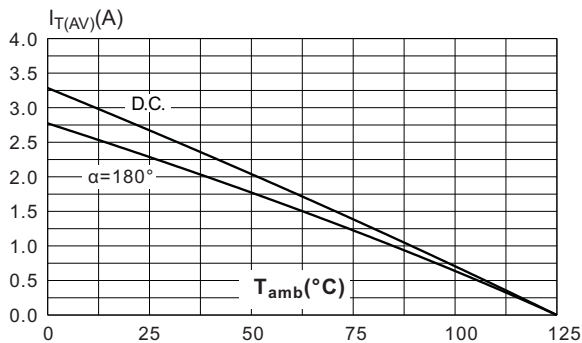

Fig.4 Relative variation of thermal impedance versus pulse duration.

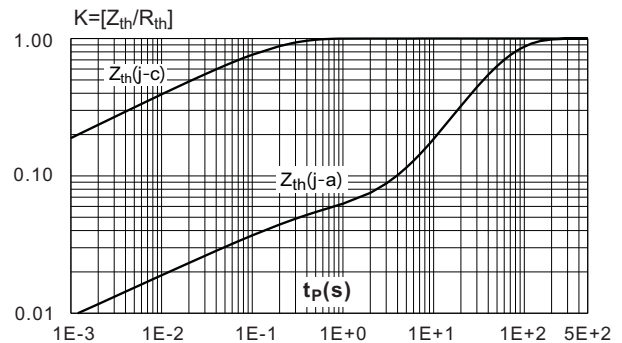

Fig.5 Relative variation of gate trigger current, holding current and latching current versus junction temperature.

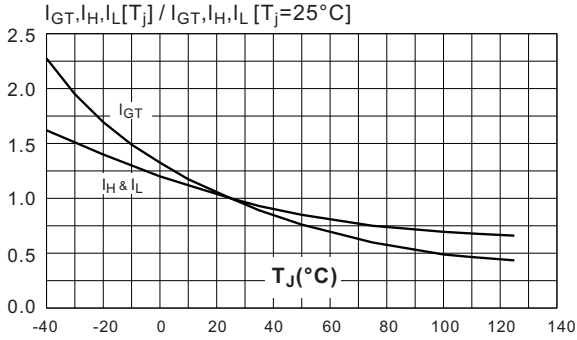

Fig.6 Surge peak on-state current versus number of cycles.

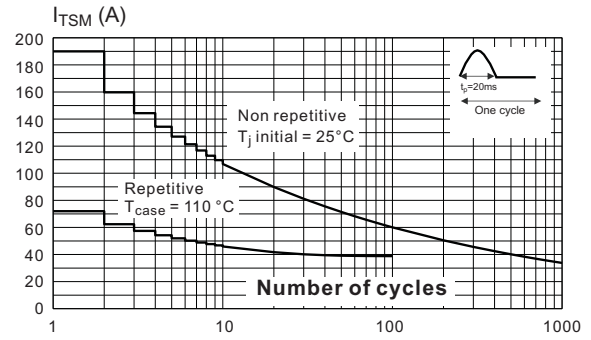

Fig.7 Non-repetitive surge peak on-state current for a sinusoidal pulse with width $t_p < 10$ ms, and corresponding values of I^2t

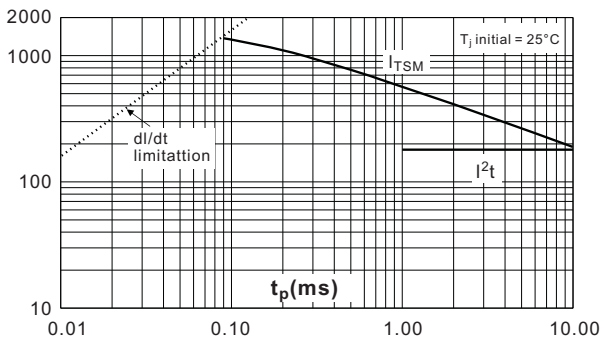

Fig.8 On-state characteristics (maximum values)

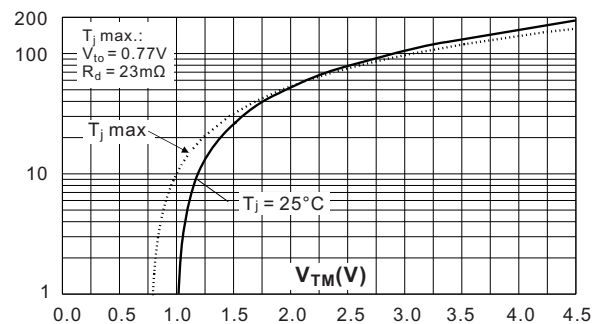
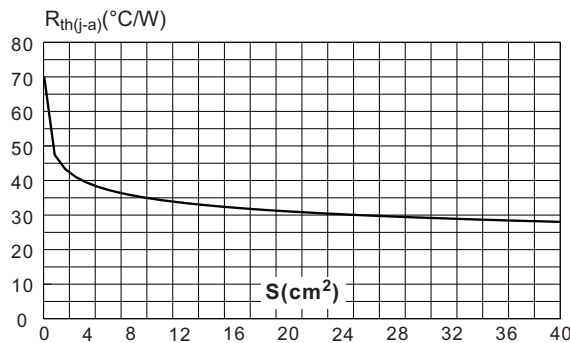
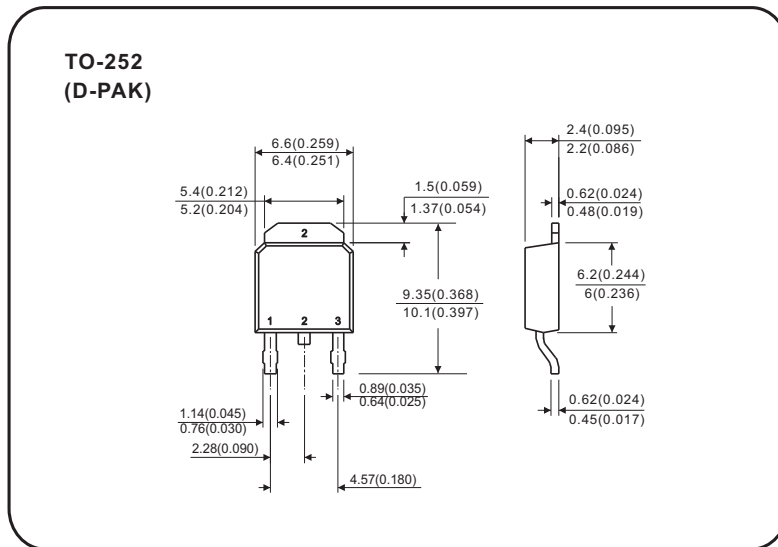
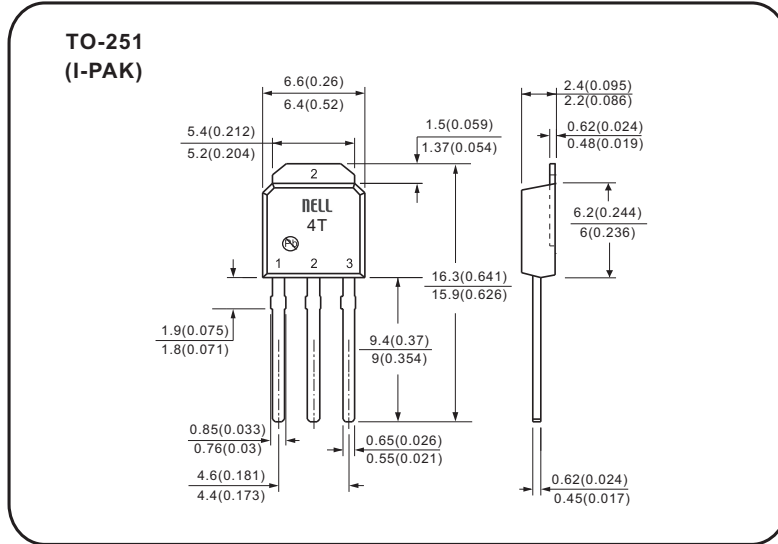

Fig.9 Thermal resistance junction to ambient versus copper surface under tab (epoxy printed circuit board Fr4, copper thickness: 35 μ m)(D²PAK)



Case Style



All dimensions in millimeters(inches)

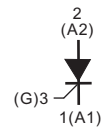

Case Style

TO-220AB

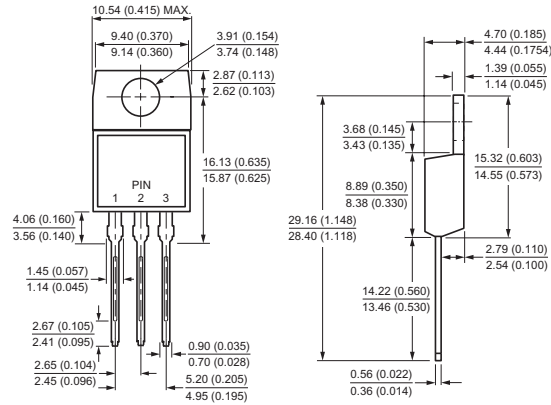

TO-263(D²PAK)

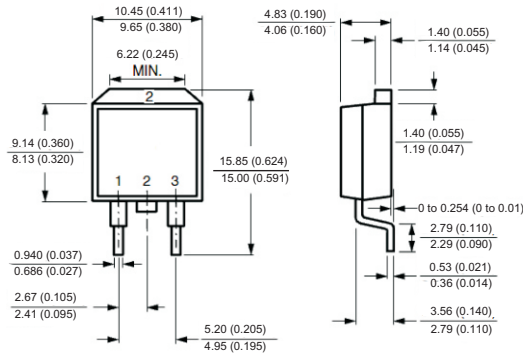

All dimensions in millimeters(inches)

