

Square Body – DIN 43 653

1250V/1300V (IEC/U.L.) 50-1400A



Electrical Characteristics						Ordering Information			Curves
Size	Rated Current RMS-Amps	I²t (A²S)			Watts Loss	-KN/110 Type K Visual Indicator for Micro	Carton Qty.	Carton Weight (kg)	BIF #
		Pre-arc	Clearing at 1000V	Clearing at 1250V					
1*	50	135	815	1100	15	170M3238	2	0.84	17056630
	63	215	1300	1750	20	170M3239			
	80	420	2500	3350	25	170M3240			
	100	750	4450	5950	30	170M3241			
	125	1450	9000	11500	35	170M3242			
	160	2600	16000	21000	40	170M3243			
	200	5150	31000	41000	45	170M3244			
	250	9200	54500	73000	55	170M3245			
	315	18500	115000	150000	60	170M3246			
	350	27000	165000	220000	65	170M3247			
400	53000	265000	335000	70	170M3248				
1	160	1900	11500	15500	45	170M4238	2	1.26	17056632
	200	3800	22500	30000	50	170M4239			
	250	7750	46000	61500	60	170M4240			
	315	15000	90000	120000	65	170M4241			
	350	20000	125000	165000	70	170M4242			
	400	29500	175000	235000	75	170M4243			
	450	42000	250000	335000	80	170M4244			
	500	69500	340000	435000	85	170M4245			
	550	95000	465000	590000	95	170M4246			
	†630	130000	660000	1000000	100	170M4247			
2	250	6500	38500	51500	65	170M5238	2	1.66	17056634
	280	9350	55500	74500	70	170M5239			
	315	13000	77500	105000	75	170M5240			
	350	16500	97500	135000	80	170M5241			
	400	23000	140000	180000	85	170M5242			
	450	34000	205000	270000	90	170M5243			
	500	48000	285000	380000	95	170M5244			
	550	62000	370000	495000	100	170M5245			
	630	115000	575000	730000	110	170M5246			
	700	160000	795000	1050000	115	170M5247			
	800	245000	1200000	1550000	120	170M5248			
	†900	360000	1750000	2350000	125	170M5249			
	†1000	480000	2350000	3150000	135	170M5250			
3	315	9500	58000	77500	85	170M6238	1	1.27	17056636
	350	13500	81500	110000	90	170M6239			
	400	19500	120000	160000	95	170M6240			
	450	31000	185000	245000	100	170M6241			
	500	39000	235000	310000	105	170M6242			
	550	55000	325000	435000	110	170M6243			
	630	83500	495000	665000	115	170M6244			
	700	115000	705000	940000	120	170M6245			
	†800	205000	995000	1300000	125	170M6246			
	†900	305000	1500000	1900000	130	170M6247			
	†1000	450000	2150000	2750000	135	170M6248			
	†1100	575000	2800000	3600000	140	170M6249			
	†1250	810000	3950000	5200000	145	170M6250			
	†1400	1250000	6000000	8100000	150	170M6251			

- Interrupting rating 100kA RMS Symmetrical.
- Watts loss provided at rated current.
- Rated voltage (IEC) †1100V †1250V (Consult Bussmann for U.L. Recognition/ CSA Component Acceptance status.)
- Microswitch indicator ordered separately.

1 kg = 2.2 lbs. 1 lb = 0.45 kg



Electrical Characteristics

Total Clearing I²t

The total clearing I²t at rated voltage and at power factor of 15% are given in the electrical characteristics. For other voltages, the clearing I²t is found by multiplying by correction factor, K, given as a function of applied working voltage, E_g, (RMS).

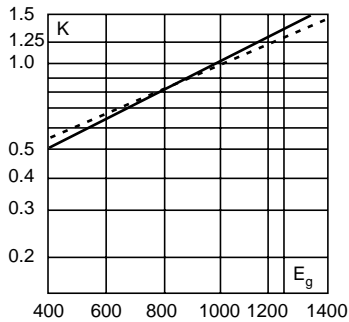

Arc Voltage

This curve gives the peak arc voltage, U_L, which may appear across the fuse during its operation as a function of the applied working voltage, E_g, (RMS) at a power factor of 15%.

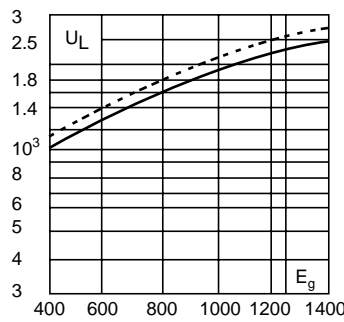

Power Losses

Watts loss at rated current is given in the electrical characteristics. The curve allows the calculation of the power losses at load currents lower than the rated current. The correction factor, K_p, is given as a function of the RMS load current, I_b, in % of the rated current.

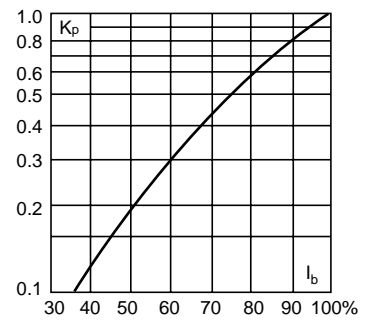

Dashed lines apply to the following amperages:

Size	1*	1	2	3
Amp	400	500-630	630-1000	800-1400

Dimensions

DIN 43 653: Type -KN/110

Size	A	B	D	E	H
1*	80	138	59	45	20
1	80	138	69	53	25
2	80	138	77	61	25
3	81	139	92	76	30

Dimension in mm.
1mm = 0.0394" 1" = 25.4mm

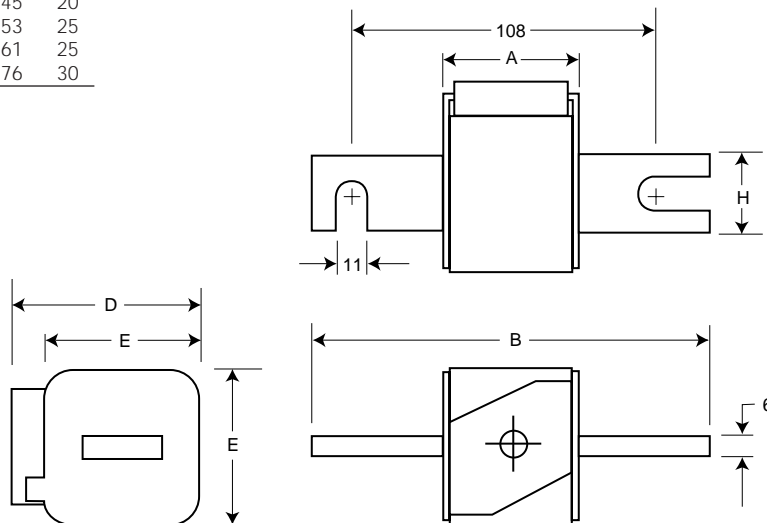

The only controlled copy of this BIF document is the electronic read-only version located on the Bussmann Network Drive. All other copies of this document are by definition uncontrolled. This bulletin is intended to clearly present comprehensive product data and provide technical information that will help the end user with design applications. Bussmann reserves the right, without notice, to change design or construction of any products and to discontinue or limit distribution of any products. Bussmann also reserves the right to change or update, without notice, any technical information contained in this bulletin. Once a product has been selected, it should be tested by the user in all possible applications.