



**SEMITRANS®2**

## Fast IGBT4 Modules

SKM50GB12T4

### Features

- IGBT4 = 4. Generation (Trench)IGBT
- VCEsat with positive temperature coefficient
- High short circuit capability, self limiting to 6 x I<sub>CNOM</sub>
- Soft switching 4. Generation CAL diode (CAL4)

### Typical Applications

- AC inverter drives
- UPS
- Electronic welders at fsw up to 20 kHz

### Remarks

- Case temperature limited to T<sub>c</sub> = 125°C max, recomm. Top = -40 ... +150°C, product rel. results valid for T<sub>j</sub> = 150°

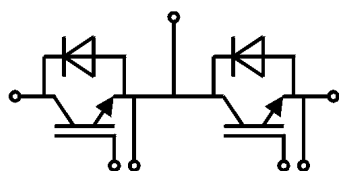

GB

Absolute Maximum Ratings				
Symbol	Conditions		Values	Unit
<b>IGBT</b>				
V <sub>CES</sub>			1200	V
I <sub>C</sub>	T <sub>j</sub> = 175 °C	T <sub>c</sub> = 25 °C	81	A
		T <sub>c</sub> = 80 °C	62	A
I <sub>Cnom</sub>			50	A
I <sub>CRM</sub>	I <sub>CRM</sub> = 3xI <sub>Cnom</sub>		150	A
V <sub>GES</sub>			-20 ... 20	V
t <sub>psc</sub>	V <sub>CC</sub> = 800 V	T <sub>j</sub> = 150 °C	10	µs
	V <sub>GE</sub> ≤ 15 V V <sub>CES</sub> ≤ 1200 V			
T <sub>j</sub>			-40 ... 175	°C
<b>Inverse diode</b>				
I <sub>F</sub>	T <sub>j</sub> = 175 °C	T <sub>c</sub> = 25 °C	65	A
		T <sub>c</sub> = 80 °C	49	A
I <sub>Fnom</sub>			50	A
I <sub>FRM</sub>	I <sub>FRM</sub> = 3xI <sub>Fnom</sub>		150	A
I <sub>FSM</sub>	t <sub>p</sub> = 10 ms, sin 180°, T <sub>j</sub> = 25 °C		270	A
T <sub>j</sub>			-40 ... 175	°C
<b>Module</b>				
I <sub>t(RMS)</sub>			200	A
T <sub>stg</sub>			-40 ... 125	°C
V <sub>isol</sub>	AC sinus 50Hz, t = 1 min		4000	V

Characteristics						
Symbol	Conditions		min.	typ.	max.	Unit
<b>IGBT</b>						
V <sub>CE(sat)</sub>	I <sub>C</sub> = 50 A V <sub>GE</sub> = 15 V chipelevel	T <sub>j</sub> = 25 °C	1.85	2.1		V
		T <sub>j</sub> = 150 °C	2.2	2.4		V
V <sub>CE0</sub>		T <sub>j</sub> = 25 °C	0.8	0.9		V
		T <sub>j</sub> = 150 °C	0.7	0.8		V
r <sub>CE</sub>	V <sub>GE</sub> = 15 V	T <sub>j</sub> = 25 °C	21.0	24.0		mΩ
		T <sub>j</sub> = 150 °C	30.0	32.0		mΩ
V <sub>GE(th)</sub>	V <sub>GE</sub> =V <sub>CE</sub> , I <sub>C</sub> = 1.7 mA		5	5.8	6.5	V
I <sub>CES</sub>	V <sub>GE</sub> = 0 V V <sub>CE</sub> = 1200 V	T <sub>j</sub> = 25 °C	0.1	0.3		mA
		T <sub>j</sub> = 150 °C				mA
C <sub>ies</sub>	V <sub>CE</sub> = 25 V V <sub>GE</sub> = 0 V	f = 1 MHz	2.77			nF
C <sub>oes</sub>		f = 1 MHz	0.20			nF
C <sub>res</sub>		f = 1 MHz	0.16			nF
Q <sub>G</sub>	V <sub>GE</sub> = - 8 V...+ 15 V		280			nC
R <sub>Gint</sub>	T <sub>j</sub> = 25 °C		4.0			Ω
t <sub>d(on)</sub>	V <sub>CC</sub> = 600 V	T <sub>j</sub> = 150 °C	98			ns
t <sub>r</sub>	I <sub>C</sub> = 50 A V <sub>GE</sub> = ±15 V	T <sub>j</sub> = 150 °C	29			ns
		R <sub>G on</sub> = 8.2 Ω	5.5			mJ
E <sub>on</sub>			5.5			mJ
t <sub>d(off)</sub>	R <sub>G off</sub> = 8.2 Ω	T <sub>j</sub> = 150 °C	325			ns
t <sub>f</sub>	di/dt <sub>on</sub> = 1700 A/µs	T <sub>j</sub> = 150 °C	75			ns
E <sub>off</sub>	di/dt <sub>off</sub> = 670 A/µs	T <sub>j</sub> = 150 °C	4.5			mJ
R <sub>th(j-c)</sub>	per IGBT			0.53		K/W

# SKM50GB12T4



SEMITRANS®2

## Fast IGBT4 Modules

SKM50GB12T4

### Features

- IGBT4 = 4. Generation (Trench)IGBT
- VCEsat with positive temperature coefficient
- High short circuit capability, self limiting to  $6 \times I_{CNOM}$
- Soft switching 4. Generation CAL diode (CAL4)

### Typical Applications

- AC inverter drives
- UPS
- Electronic welders at fsw up to 20 kHz

### Remarks

- Case temperature limited to  $T_c = 125^\circ\text{C}$  max, recomm.  
Top =  $-40 \dots +150^\circ\text{C}$ , product rel. results valid for  $T_j = 150^\circ$

Characteristics						
Symbol	Conditions		min.	typ.	max.	Unit
<b>Inverse diode</b>						
$V_F = V_{EC}$	$I_F = 50 \text{ A}$ $V_{GE} = 0 \text{ V}$ chip	$T_j = 25^\circ\text{C}$		2.22	2.54	V
		$T_j = 150^\circ\text{C}$		2.18	2.5	V
$V_{F0}$		$T_j = 25^\circ\text{C}$		1.3	1.5	V
		$T_j = 150^\circ\text{C}$		0.9	1.1	V
$r_F$		$T_j = 25^\circ\text{C}$		18.4	20.8	m $\Omega$
		$T_j = 150^\circ\text{C}$		25.6	28.0	m $\Omega$
$I_{RRM}$	$I_F = 50 \text{ A}$ $di/dt_{off} = 1380 \text{ A}/\mu\text{s}$ $V_{GE} = \pm 15 \text{ V}$ $V_{CC} = 600 \text{ V}$	$T_j = 150^\circ\text{C}$		35		A
$Q_{rr}$		$T_j = 150^\circ\text{C}$		8.7		$\mu\text{C}$
$E_{rr}$		$T_j = 150^\circ\text{C}$		3.8		mJ
$R_{th(j-c)}$	per diode				0.84	K/W
<b>Module</b>						
$L_{CE}$					30	nH
$R_{CC'+EE'}$	terminal-chip	$T_c = 25^\circ\text{C}$		0.65		m $\Omega$
		$T_c = 125^\circ\text{C}$		1		m $\Omega$
$R_{th(c-s)}$	per module			0.04	0.05	K/W
$M_s$	to heat sink M6			3	5	Nm
$M_t$		to terminals M5		2.5	5	Nm
						Nm
$w$					160	g

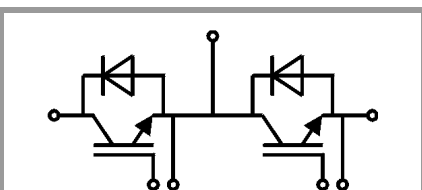

GB

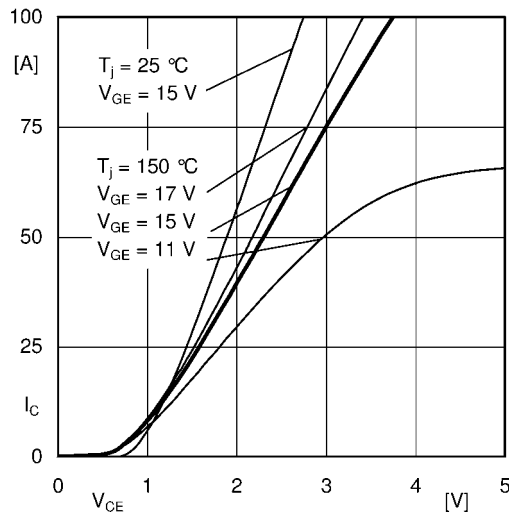

Fig. 1: Typ. output characteristic, inclusive  $R_{CC'+EE'}$

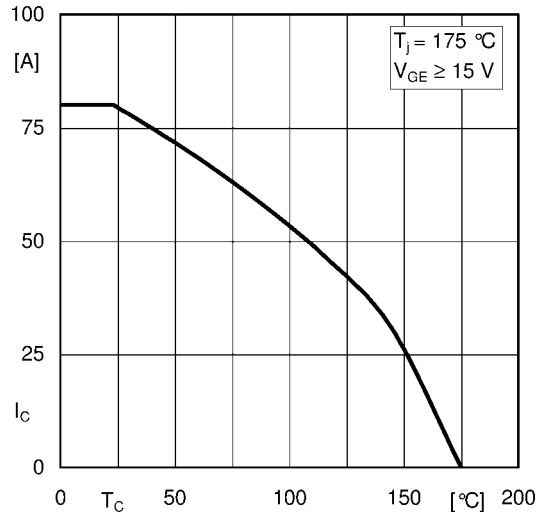

Fig. 2: Rated current vs. temperature  $I_c = f(T_C)$

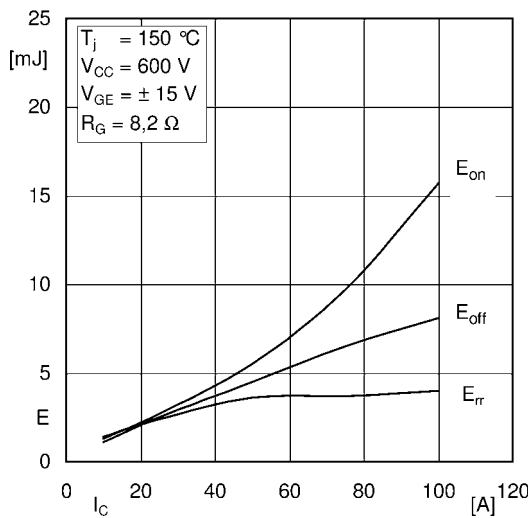

Fig. 3: Typ. turn-on /-off energy =  $f(I_c)$

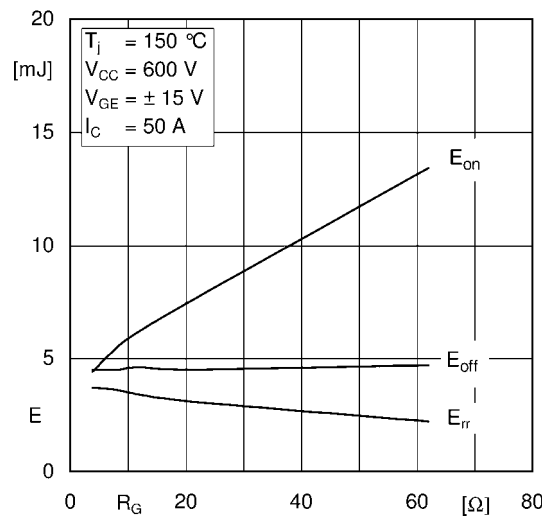

Fig. 4: Typ. turn-on /-off energy =  $f(R_G)$

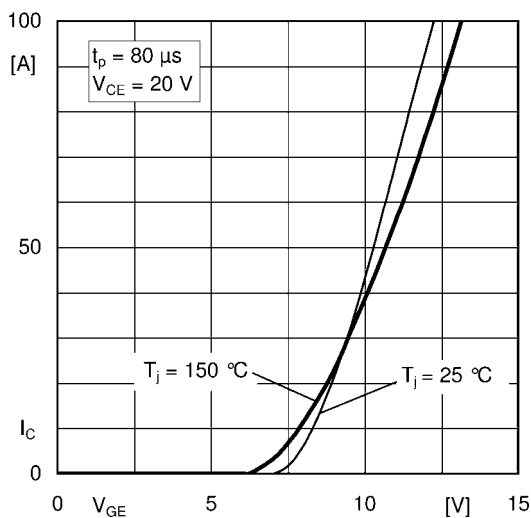

Fig. 5: Typ. transfer characteristic

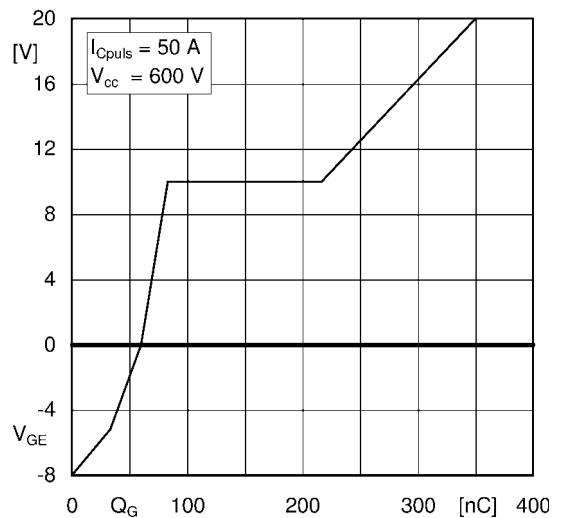

Fig. 6: Typ. gate charge characteristic

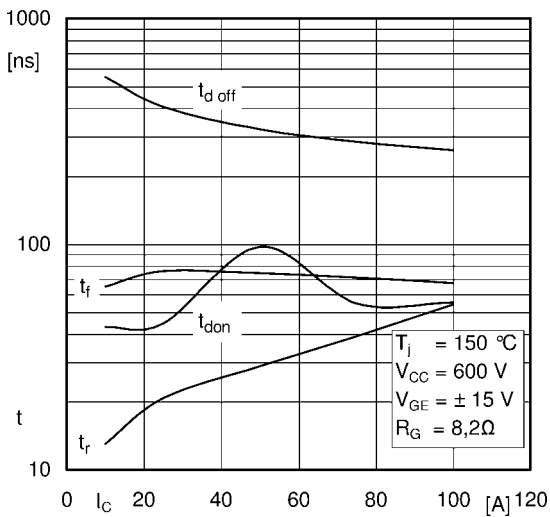

Fig. 7: Typ. switching times vs.  $I_C$

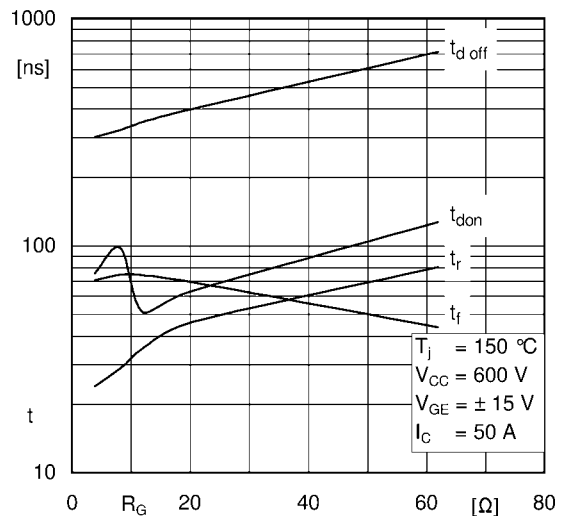

Fig. 8: Typ. switching times vs. gate resistor  $R_G$

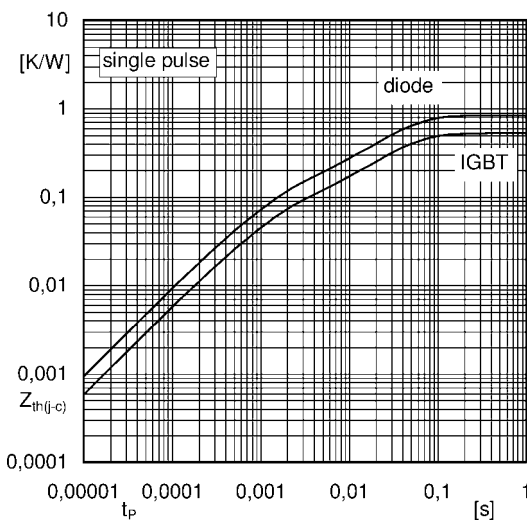

Fig. 9: Transient thermal impedance

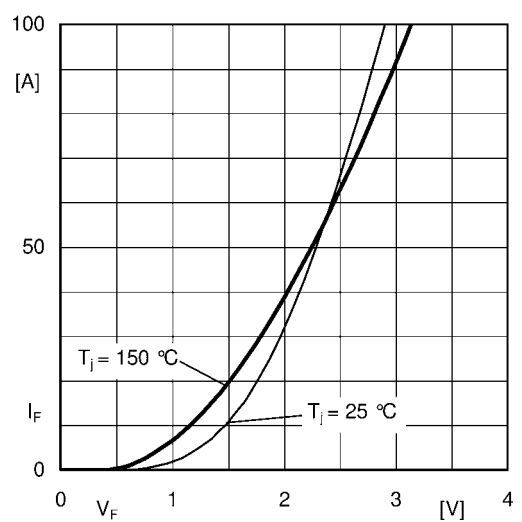

Fig. 10: CAL diode forward characteristic

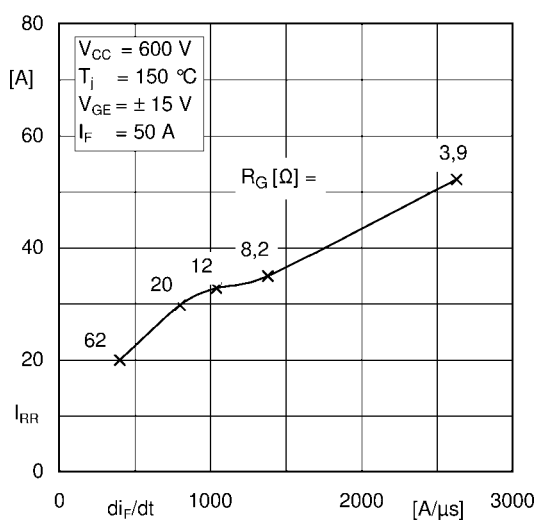

Fig. 11: CAL diode peak reverse recovery current

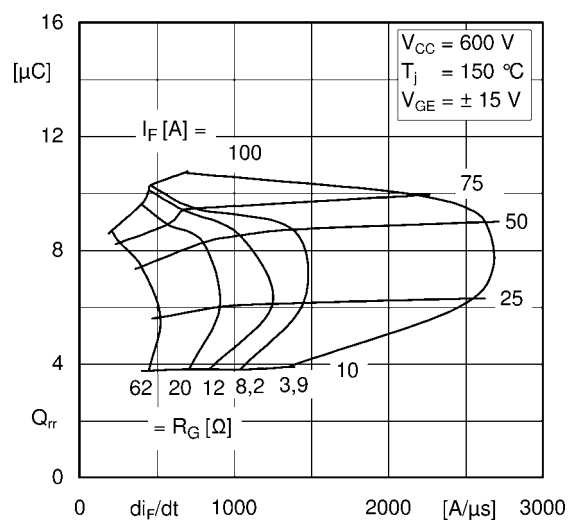
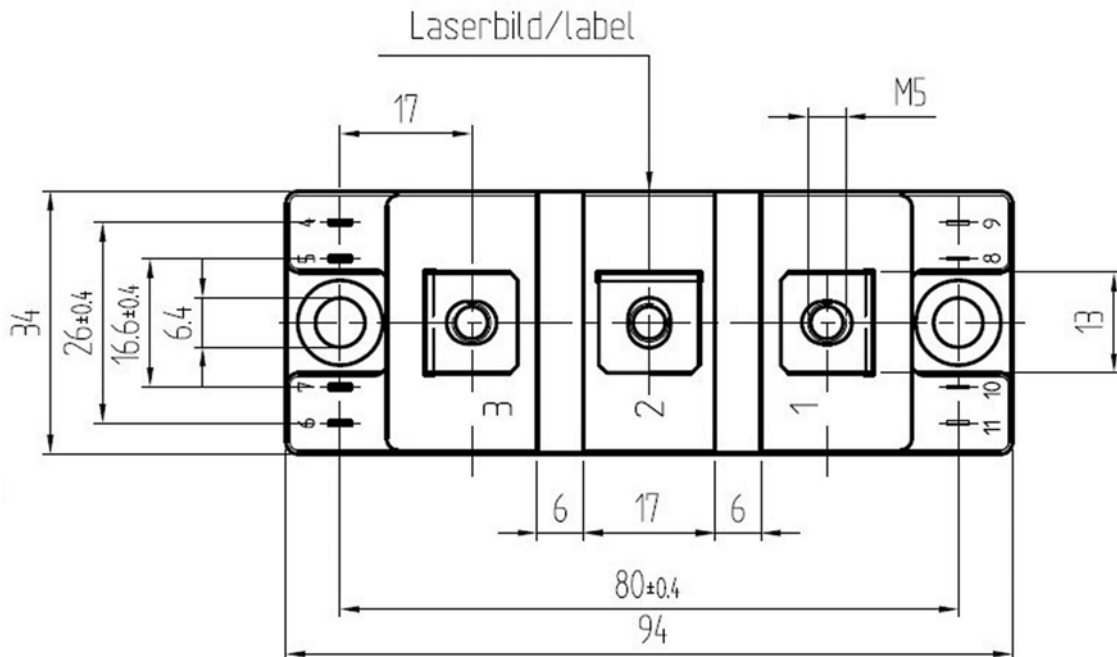
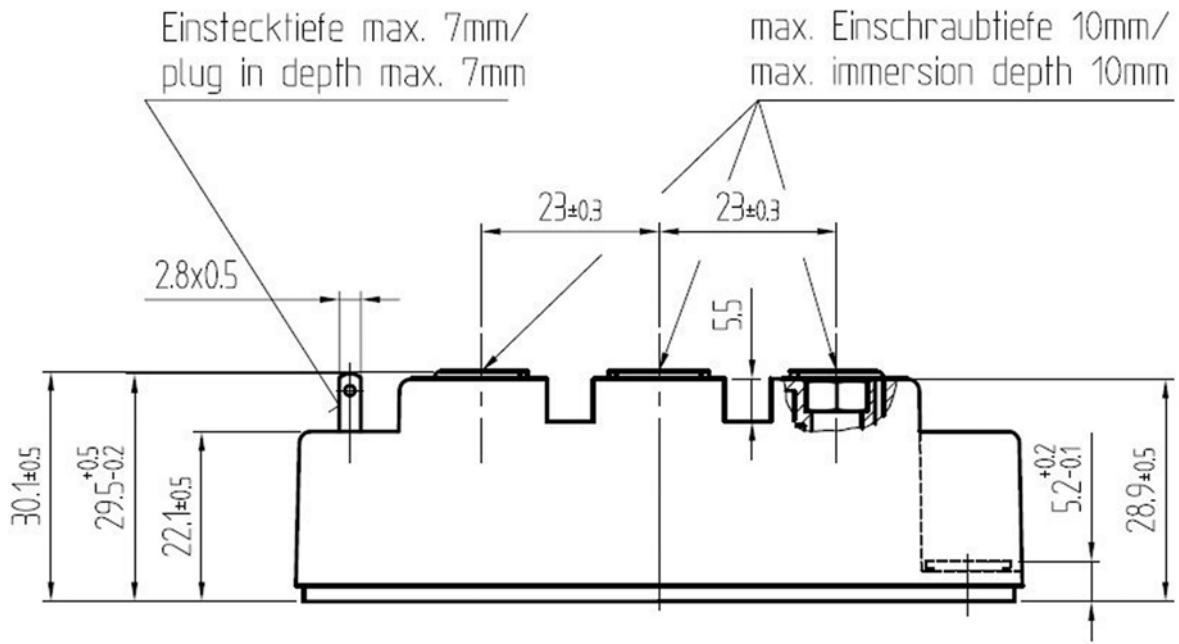
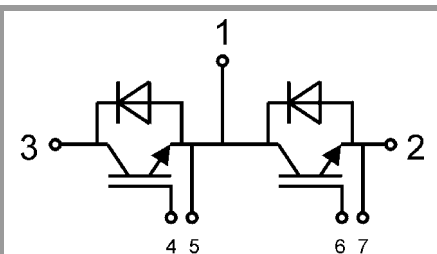

Fig. 12: Typ. CAL diode peak reverse recovery charge

# SKM50GB12T4



Semitrans 2



GB

This is an electrostatic discharge sensitive device (ESDS), international standard IEC 60747-1, Chapter IX.

This technical information specifies semiconductor devices but promises no characteristics. No warranty or guarantee expressed or implied is made regarding delivery, performance or suitability.