



**SEMITRANS® 2**

## Trench IGBT Modules

**SKM195GB066D**

### Features

- Homogeneous Si
- Trench = Trenchgate technology
- $V_{CE(sat)}$  with positive temperature coefficient
- High short circuit capability, self limiting to  $6 \times I_C$

### Typical Applications\*

- AC inverter drives
- UPS
- Electronic welders

### Remarks

- Case temperature limited to  $T_c = 125^\circ\text{C}$  max., product rel. results valid for  $T_j \leq 150^\circ\text{C}$
- SC data: Use of soft  $R_G$  necessary!
- Take care of over-voltage caused by stray induct.

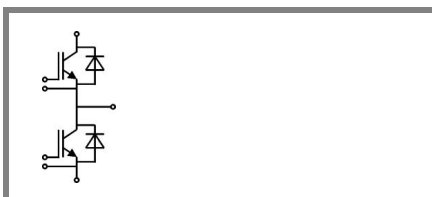

**GB**

Absolute Maximum Ratings		$T_{case} = 25^\circ\text{C}$ , unless otherwise specified		
Symbol	Conditions	Values	Units	
<b>IGBT</b>				
$V_{CES}$	$T_j = 25^\circ\text{C}$	600	V	
$I_C$	$T_j = 175^\circ\text{C}$	$T_c = 25^\circ\text{C}$	265	A
		$T_c = 80^\circ\text{C}$	200	A
$I_{CRM}$	$I_{CRM} = 2 \times I_{Cnom}$	400	A	
$V_{GES}$		$\pm 20$	V	
$t_{psc}$	$V_{CC} = 360\text{ V}; V_{GE} \leq 15\text{ V}; T_j = 150^\circ\text{C}$ $V_{CES} < 600\text{ V}$	6	$\mu\text{s}$	
<b>Inverse Diode</b>				
$I_F$	$T_j = 175^\circ\text{C}$	$T_c = 25^\circ\text{C}$	200	A
		$T_c = 80^\circ\text{C}$	130	A
$I_{FRM}$	$I_{FRM} = 2 \times I_{Fnom}$	400	A	
$I_{FSM}$	$t_p = 10\text{ ms}; \text{sin.}$	$T_j = 175^\circ\text{C}$	1400	A
<b>Module</b>				
$I_t(\text{RMS})$		200	A	
$T_{vj}$		- 40 ... + 175	$^\circ\text{C}$	
$T_{stg}$		- 40 ... + 125	$^\circ\text{C}$	
$V_{isol}$	AC, 1 min.	4000	V	

Characteristics		$T_{case} = 25^\circ\text{C}$ , unless otherwise specified			
Symbol	Conditions	min.	typ.	max.	Units
<b>IGBT</b>					
$V_{GE(th)}$	$V_{GE} = V_{CE}, I_C = 3,2\text{ mA}$	5	5,8	6,5	V
$I_{CES}$	$V_{GE} = 0\text{ V}, V_{CE} = V_{CES}$	$T_j = 25^\circ\text{C}$	0,13	0,38	mA
			$T_j = 150^\circ\text{C}$	0,85	
$V_{CE0}$		$T_j = 25^\circ\text{C}$	0,9	1	V
			$T_j = 150^\circ\text{C}$	0,85	0,9
$r_{CE}$	$V_{GE} = 15\text{ V}$	$T_j = 25^\circ\text{C}$	2,8	4,5	$\text{m}\Omega$
		$T_j = 150^\circ\text{C}$	4,3	6	$\text{m}\Omega$
$V_{CE(sat)}$	$I_{Cnom} = 200\text{ A}, V_{GE} = 15\text{ V}$	$T_j = 25^\circ\text{C}_{chiplev.}$	1,45	1,9	V
		$T_j = 150^\circ\text{C}_{chiplev.}$	1,7	2,1	V
$C_{res}$	$V_{CE} = 25, V_{GE} = 0\text{ V}$	$f = 1\text{ MHz}$	12,3		nF
$C_{oes}$			0,77		nF
$C_{res}$			0,37		nF
$Q_G$	$V_{GE} = -8\text{V}...+15\text{V}$		1500		nC
$R_{Gint}$	$T_j = ^\circ\text{C}$		2		$\Omega$
$t_{d(on)}$	$R_{Gon} = 3\ \Omega$	$V_{CC} = 300\text{V}$ $I_C = 200\text{A}$	160		ns
$t_r$			68		ns
$E_{on}$	$R_{Goff} = 3\ \Omega$	$T_j = 150^\circ\text{C}$ $V_{GE} = -8\text{V}/+15\text{V}$	14		mJ
$t_{d(off)}$			520		ns
$t_f$			49		ns
$E_{off}$			8		mJ
$R_{th(j-c)}$	per IGBT			0,22	K/W



**SEMITRANS® 2**

## Trench IGBT Modules

**SKM195GB066D**

### Features

- Homogeneous Si
- Trench = Trenchgate technology
- $V_{CE(sat)}$  with positive temperature coefficient
- High short circuit capability, self limiting to  $6 \times I_C$

### Typical Applications\*

- AC inverter drives
- UPS
- Electronic welders

### Remarks

- Case temperature limited to  $T_c = 125^\circ\text{C}$  max., product rel. results valid for  $T_j \leq 150^\circ\text{C}$
- SC data: Use of soft  $R_G$  necessary!
- Take care of over-voltage caused by stray induct.

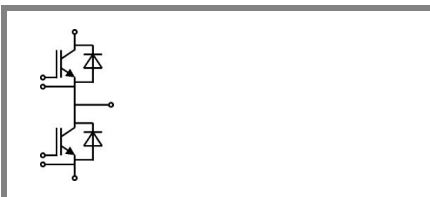

**GB**

Characteristics		min.	typ.	max.	Units
<b>Symbol</b>	<b>Conditions</b>				
<b>Inverse Diode</b>					
$V_F = V_{EC}$	$I_{Fnom} = 200 \text{ A}; V_{GE} = 0 \text{ V}$ $T_j = 25^\circ\text{C}_{chiplev.}$		1,4	1,6	V
$V_{F0}$	$T_j = 25^\circ\text{C}$		0,95	1	V
$r_F$	$T_j = 25^\circ\text{C}$		2,3	3	mΩ
$I_{RRM}$	$I_F = 200 \text{ A}$ $T_j = 150^\circ\text{C}$		100		A
$Q_{rr}$	$di/dt = 2000 \text{ A}/\mu\text{s}$		30		μC
$E_{rr}$	$V_{GE} = -8 \text{ V}; V_{CC} = 300 \text{ V}$		5,6		mJ
$R_{th(j-c)D}$	per diode			0,4	K/W
<b>Module</b>					
$L_{CE}$				30	nH
$R_{CC+EE}$	res., terminal-chip	$T_{case} = 25^\circ\text{C}$	0,75		mΩ
		$T_{case} = 125^\circ\text{C}$	1		mΩ
$R_{th(c-s)}$	per module			0,05	K/W
$M_s$	to heat sink M6		3	5	Nm
$M_t$	to terminals M5		2,5	5	Nm
w				150	g

This is an electrostatic discharge sensitive device (ESDS), international standard IEC 60747-1, Chapter IX.

\* The specifications of our components may not be considered as an assurance of component characteristics. Components have to be tested for the respective application. Adjustments may be necessary. The use of SEMIKRON products in life support appliances and systems is subject to prior specification and written approval by SEMIKRON. We therefore strongly recommend prior consultation of our staff.

# SKM 195GB066D

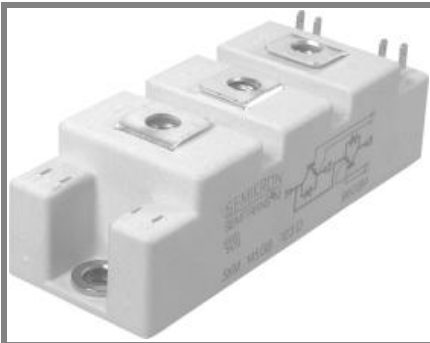

**SEMITRANS<sup>®</sup> 2**

## Trench IGBT Modules

**SKM195GB066D**

### Features

- Homogeneous Si
- Trench = Trenchgate technology
- $V_{CE(sat)}$  with positive temperature coefficient
- High short circuit capability, self limiting to  $6 \times I_C$

### Typical Applications\*

- AC inverter drives
- UPS
- Electronic welders

### Remarks

- Case temperature limited to  $T_c = 125^\circ\text{C}$  max., product rel. results valid for  $T_j \leq 150^\circ\text{C}$
- SC data: Use of soft  $R_G$  necessary!
- Take care of over-voltage caused by stray induct.

$Z_{th}$		Conditions	Values	Units
<b>Symbol</b>				
$Z_{th(j-c)I}$				
$R_{\theta i}$		i = 1	160	mk/W
$R_{\theta i}$		i = 2	41	mk/W
$R_{\theta i}$		i = 3	16	mk/W
$R_{\theta i}$		i = 4	3	mk/W
$\tau_{\theta i}$		i = 1	0,0276	s
$\tau_{\theta i}$		i = 2	0,0406	s
$\tau_{\theta i}$		i = 3	0,001	s
$\tau_{\theta i}$		i = 4	0,0011	s
$Z_{th(j-c)D}$				
$R_{\theta i}$		i = 1	250	mk/W
$R_{\theta i}$		i = 2	110	mk/W
$R_{\theta i}$		i = 3	35	mk/W
$R_{\theta i}$		i = 4	5	mk/W
$\tau_{\theta i}$		i = 1	0,054	s
$\tau_{\theta i}$		i = 2	0,012	s
$\tau_{\theta i}$		i = 3	0,0015	s
$\tau_{\theta i}$		i = 4	0,0007	s

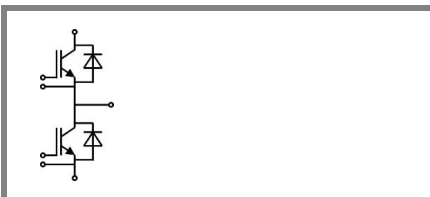

**GB**

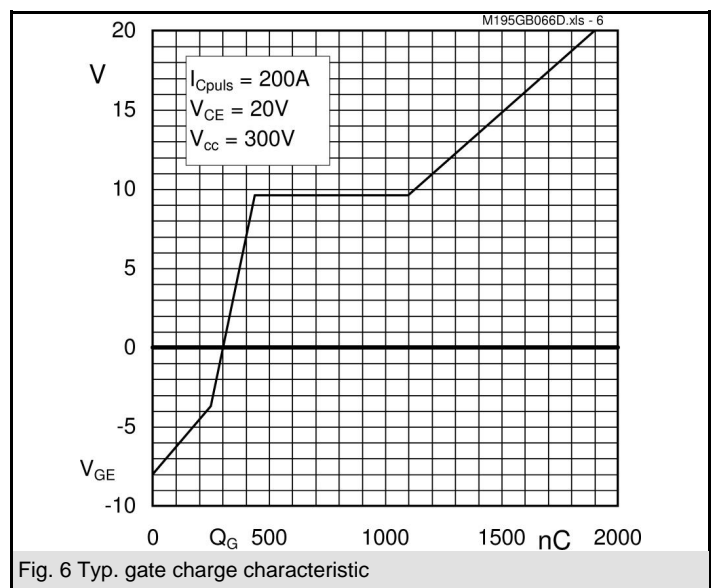
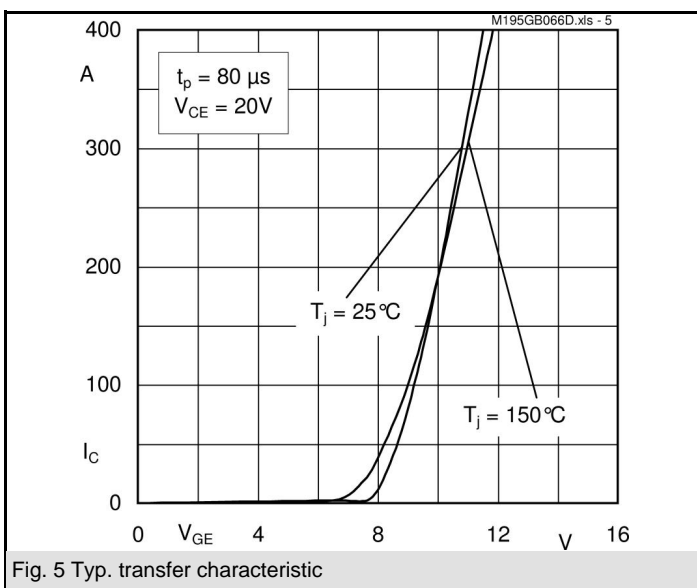
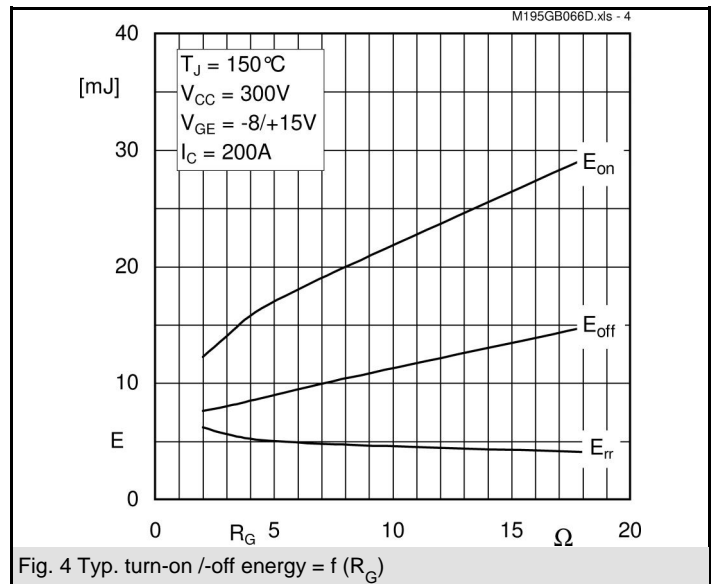
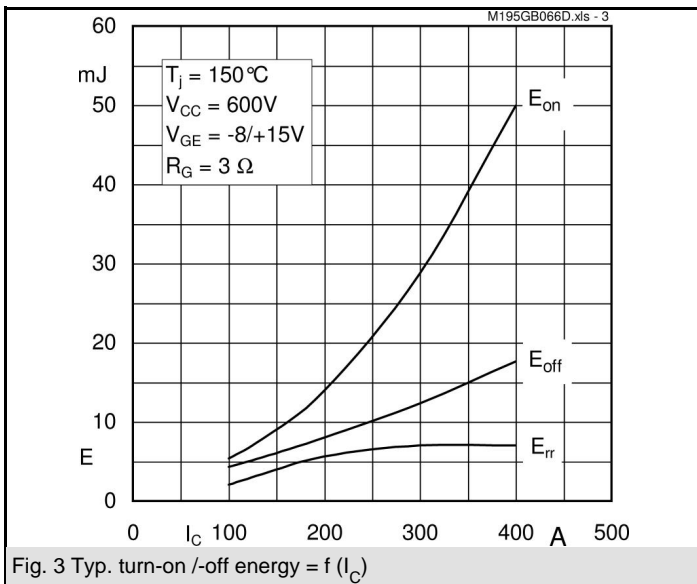
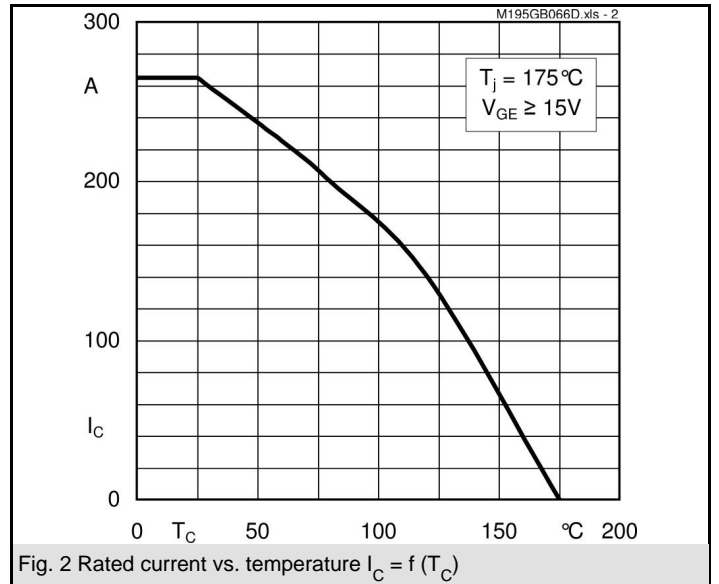
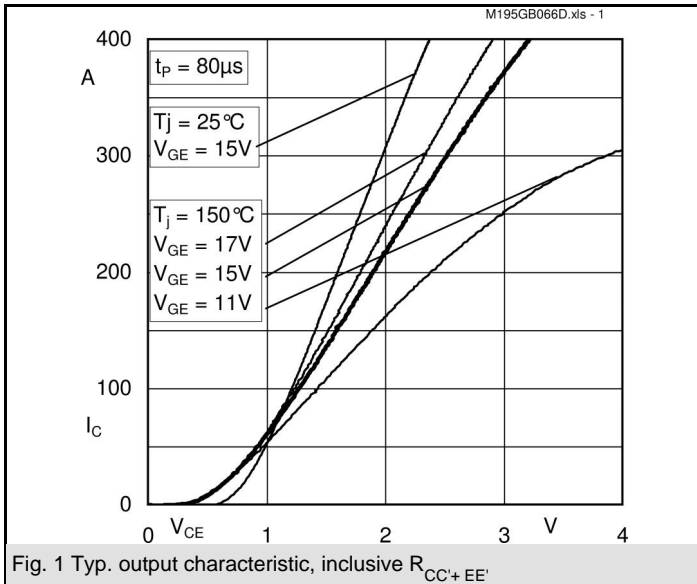

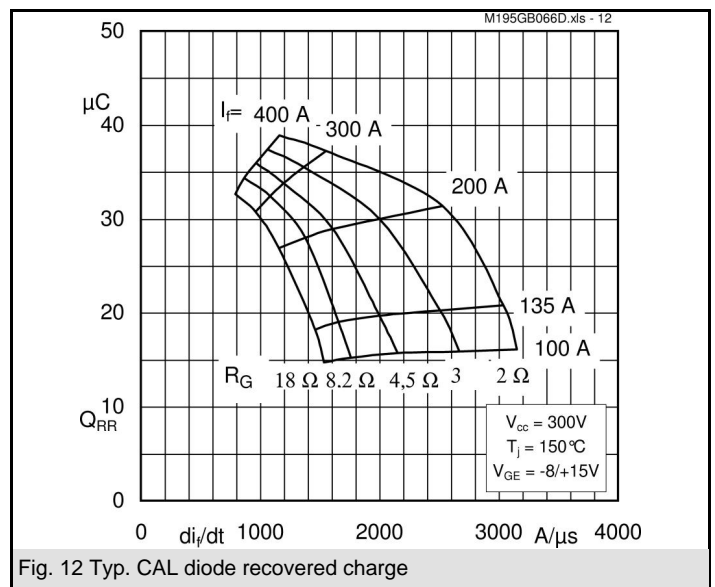
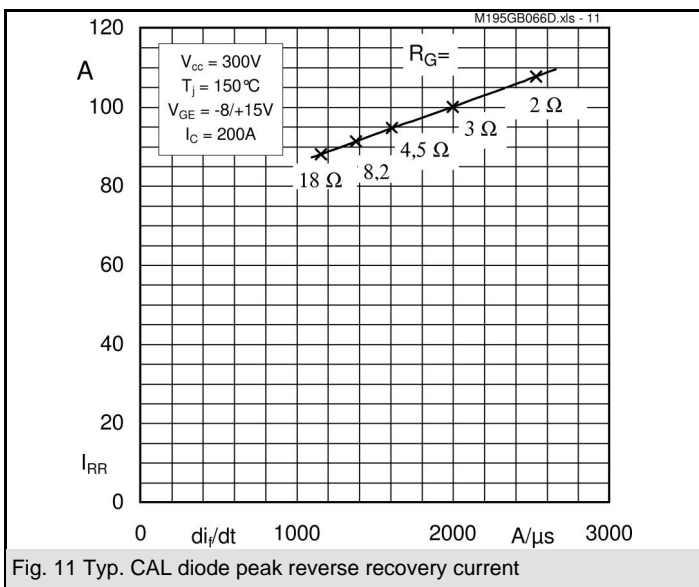
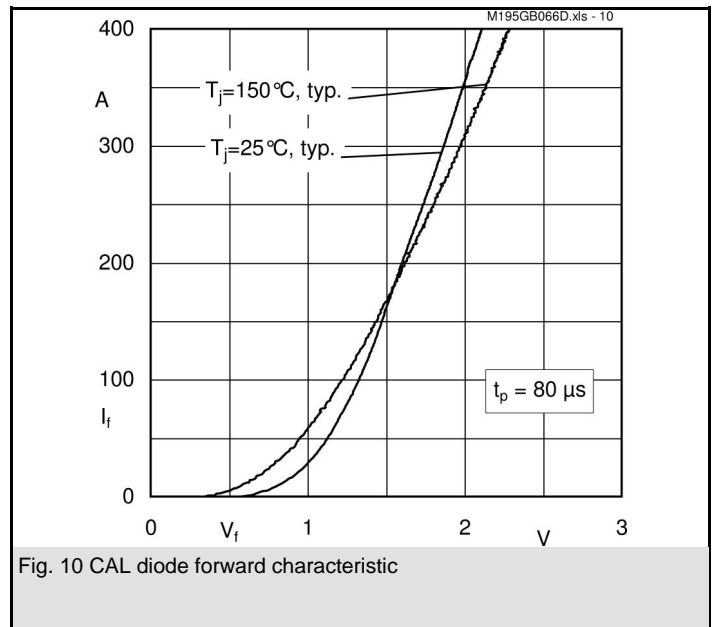
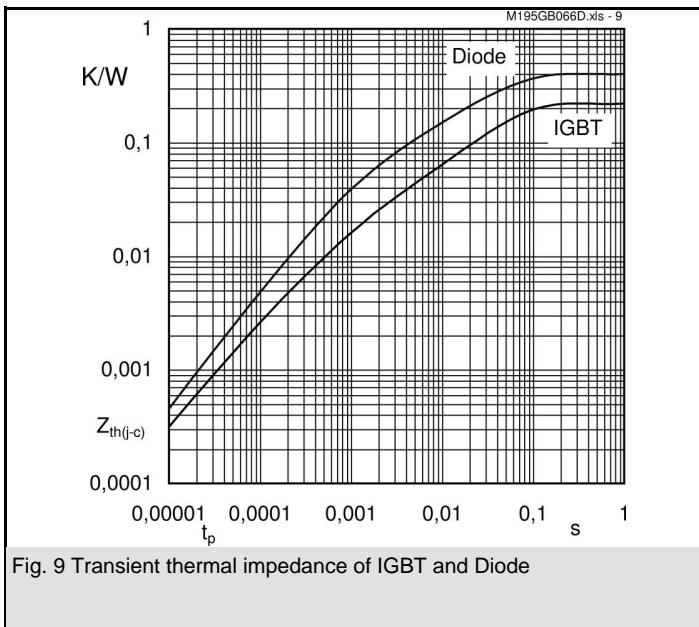
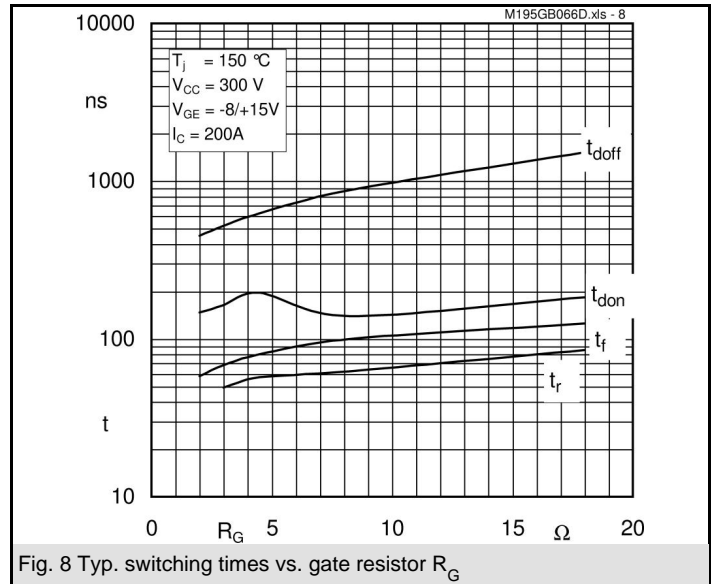
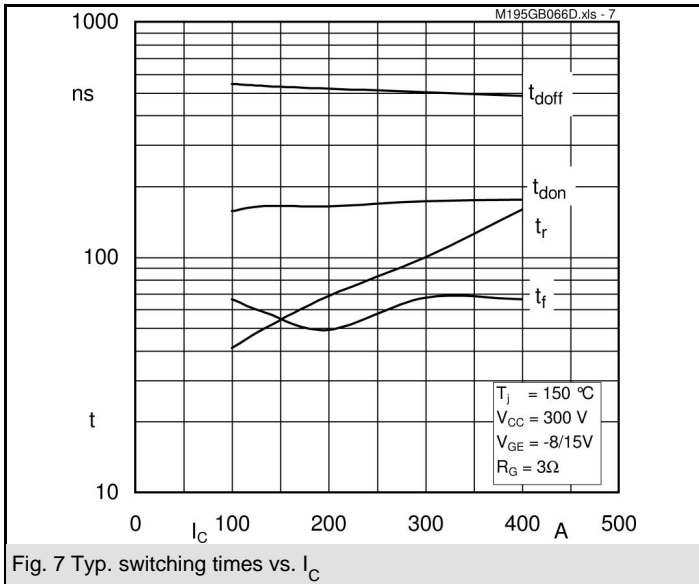

# SKM 195GB066D

UL recognized, file no. E 63 532

CASED61

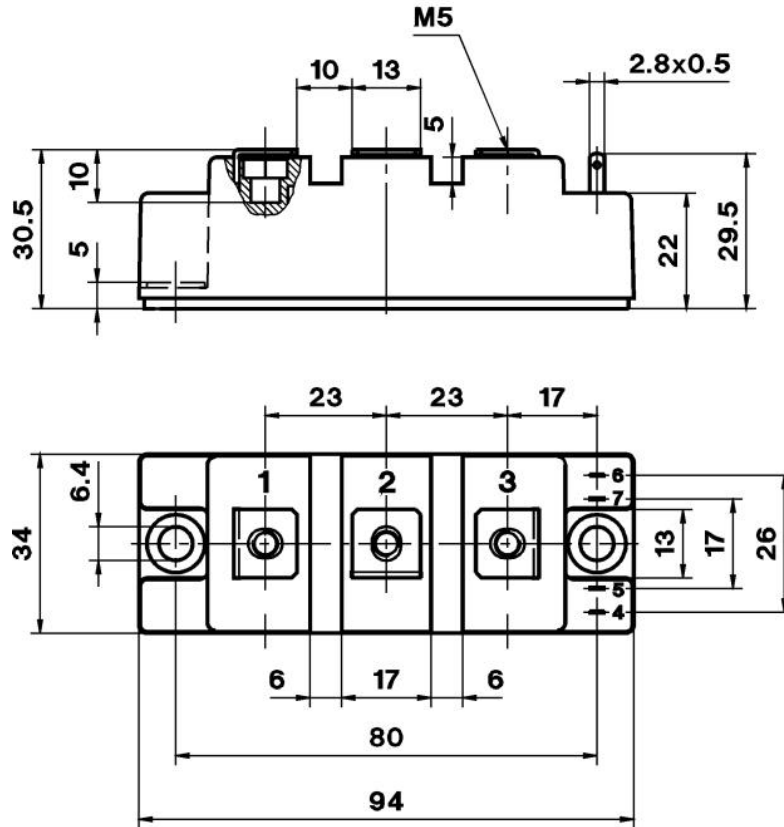

Case D 61

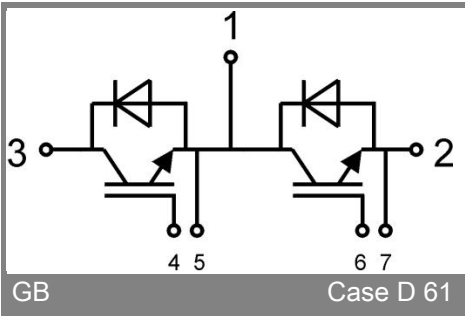

GB

Case D 61