

# SKM 300GB128D ...

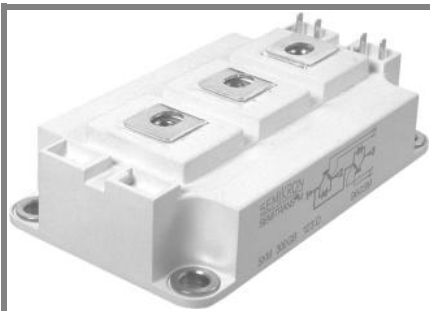

**SEMITRANS® 3**

## SPT IGBT Module

**SKM 300GB128D**

**SKM 300GAL128D**

### Features

- Homogeneous Si
- SPT = Soft-Punch-Through technology
- $V_{CEsat}$  with positive temperature coefficient
- High short circuit capability, self limiting to  $6 \times I_C$

### Typical Applications

- AC inverter drives
- UPS
- Electronic welders at  $f_{sw}$  up to 20 kHz

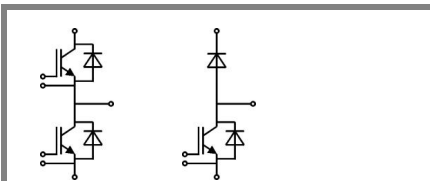

**GB**

**GAL**

Absolute Maximum Ratings		$T_C = 25\text{ }^\circ\text{C}$ , unless otherwise specified		
Symbol	Conditions	Values		Units
<b>IGBT</b>				
$V_{CES}$	$T_j = 25\text{ }^\circ\text{C}$	1200		V
$I_C$	$T_j = 150\text{ }^\circ\text{C}$	$T_C = 25\text{ }^\circ\text{C}$	370	A
		$T_C = 80\text{ }^\circ\text{C}$	265	A
$I_{CRM}$	$I_{CRM} = 2 \times I_{Cnom}$	400		A
$V_{GES}$		$\pm 20$		V
$t_{psc}$	$V_{CC} = 600\text{ V}; V_{GE} \leq 20\text{ V}; T_j = 125\text{ }^\circ\text{C}$ $V_{CES} < 1200\text{ V}$	10		$\mu\text{s}$
<b>Inverse Diode</b>				
$I_F$	$T_j = 150\text{ }^\circ\text{C}$	$T_{case} = 25\text{ }^\circ\text{C}$	260	A
		$T_{case} = 80\text{ }^\circ\text{C}$	180	A
$I_{FRM}$	$I_{FRM} = 2 \times I_{Fnom}$	400		A
$I_{FSM}$	$t_p = 10\text{ ms}; \text{sin.}$	$T_j = 150\text{ }^\circ\text{C}$	1800	A
<b>Freewheeling Diode</b>				
$I_F$	$T_j = 150\text{ }^\circ\text{C}$	$T_{case} = 25\text{ }^\circ\text{C}$	260	A
		$T_{case} = 80\text{ }^\circ\text{C}$	180	A
$I_{FRM}$	$I_{FRM} = 2 \times I_{Fnom}$	400		A
$I_{FSM}$	$t_p = 10\text{ ms}; \text{sin.}$	$T_j = 150\text{ }^\circ\text{C}$	1800	A
<b>Module</b>				
$I_{t(RMS)}$		500		A
$T_{vj}$		- 40...+ 150		$^\circ\text{C}$
$T_{stg}$		- 40...+ 125		$^\circ\text{C}$
$V_{isol}$	AC, 1 min.	4000		V

Characteristics		$T_C = 25\text{ }^\circ\text{C}$ , unless otherwise specified			
Symbol	Conditions	min.	typ.	max.	Units
<b>IGBT</b>					
$V_{GE(th)}$	$V_{GE} = V_{CE}, I_C = 8\text{ mA}$	4,5	5,5	6,5	V
$I_{CES}$	$V_{GE} = 0\text{ V}, V_{CE} = V_{CES}$		0,2	0,6	mA
$V_{CE0}$		$T_j = 25\text{ }^\circ\text{C}$	1	1,15	V
		$T_j = 125\text{ }^\circ\text{C}$	0,9	1,05	V
$r_{CE}$	$V_{GE} = 15\text{ V}$	$T_j = 25\text{ }^\circ\text{C}$	4,5	6	m $\Omega$
		$T_j = 125\text{ }^\circ\text{C}$	6	7,5	m $\Omega$
$V_{CE(sat)}$	$I_{Cnom} = 200\text{ A}, V_{GE} = 15\text{ V}$	$T_j = 25\text{ }^\circ\text{C}_{chiplev.}$	1,9	2,35	V
		$T_j = 125\text{ }^\circ\text{C}_{chiplev.}$	2,1	2,55	V
$C_{ies}$	$V_{CE} = 25, V_{GE} = 0\text{ V}$	$f = 1\text{ MHz}$	17		nF
$C_{oes}$			2		nF
$C_{res}$			1,9		nF
$Q_G$	$V_{GE} = -8\text{ V} - +20\text{ V}$	2400		nC	
$R_{Gint}$	$T_j = 25\text{ }^\circ\text{C}$	2		$\Omega$	
$t_{d(on)}$	$R_{Gon} = 5\text{ }^\circ\Omega$	$V_{CC} = 600\text{ V}$ $I_{Cnom} = 200\text{ A}$	170		ns
			$T_j = 125\text{ }^\circ\text{C}$	55	ns
$E_{on}$	$R_{Goff} = 5\text{ }^\circ\Omega$	$V_{GE} = \pm 15\text{ V}$ $I_s = 20\text{ nH}$	22		mJ
$t_{d(off)}$			660		ns
$t_f$			60		ns
$E_{off}$			22		mJ
$R_{th(j-c)}$	per IGBT			0,085	K/W

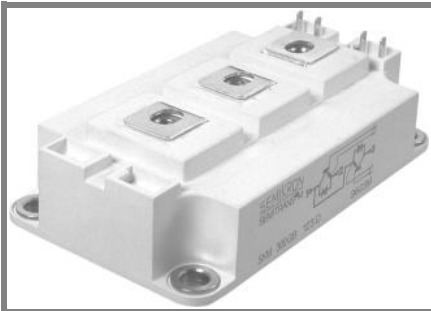

**SEMITRANS® 3**

## SPT IGBT Module

**SKM 300GB128D**

**SKM 300GAL128D**

### Features

- Homogeneous Si
- SPT = Soft-Punch-Through technology
- $V_{CEsat}$  with positive temperature coefficient
- High short circuit capability, self limiting to  $6 \times I_c$

### Typical Applications

- AC inverter drives
- UPS
- Electronic welders at  $f_{sw}$  up to 20 kHz

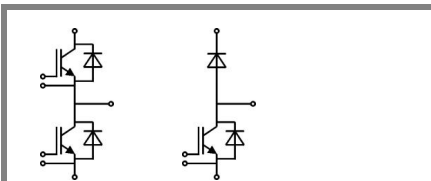

**GB**

**GAL**

Characteristics						
Symbol	Conditions		min.	typ.	max.	Units
<b>Inverse Diode</b>						
$V_F = V_{EC}$	$I_{Fnom} = 200 \text{ A}; V_{GE} = 0 \text{ V}$	$T_j = 25 \text{ }^\circ\text{C}_{chiplev.}$		2	2,5	V
		$T_j = 125 \text{ }^\circ\text{C}_{chiplev.}$		1,8		V
$V_{F0}$		$T_j = 25 \text{ }^\circ\text{C}$		1,1	1,2	V
$r_F$		$T_j = 25 \text{ }^\circ\text{C}$		4,5	6,5	mΩ
$I_{RRM}$	$I_{Fnom} = 200 \text{ A}$	$T_j = 125 \text{ }^\circ\text{C}$		280		A
$Q_{rr}$	$di/dt = 6300 \text{ A}/\mu\text{s}$	$L_S = 20 \text{ nH}$		33		μC
$E_{rr}$	$V_{GE} = -15 \text{ V}; V_{CC} = 600 \text{ V}$			11		mJ
$R_{th(j-c)D}$	per diode				0,18	K/W
<b>FWD</b>						
$V_F = V_{EC}$	$I_{Fnom} = 200 \text{ A}; V_{GE} = 0 \text{ V}$	$T_j = 25 \text{ }^\circ\text{C}_{chiplev.}$		2	2,5	V
		$T_j = 125 \text{ }^\circ\text{C}_{chiplev.}$		1,8		V
$V_{F0}$		$T_j = 25 \text{ }^\circ\text{C}$		1,1	1,2	V
$r_F$		$T_j = 25 \text{ }^\circ\text{C}$		4,5	6,5	V
$I_{RRM}$	$I_{Fnom} = 200 \text{ A}$	$T_j = 25 \text{ }^\circ\text{C}$		280		A
$Q_{rr}$	$di/dt = 6300 \text{ A}/\mu\text{s}$	$L_S = 20 \text{ nH}$		33		μC
$E_{rr}$	$V_{GE} = -15 \text{ V}; V_{CC} = 600 \text{ V}$			11		mJ
$R_{th(j-c)FD}$	per diode				0,18	K/W
<b>Module</b>						
$L_{CE}$				15	20	nH
$R_{CC+EE'}$	res., terminal-chip	$T_{case} = 25 \text{ }^\circ\text{C}$		0,35		mΩ
		$T_{case} = 125 \text{ }^\circ\text{C}$		0,5		mΩ
$R_{th(c-s)}$	per module				0,038	K/W
$M_s$	to heat sink M6			3	5	Nm
$M_t$	to terminals M6			2,5	5	Nm
w					325	g

This is an electrostatic discharge sensitive device (ESDS), international standard IEC 60747-1, Chapter IX.

This technical information specifies semiconductor devices but promises no characteristics. No warranty or guarantee expressed or implied is made regarding delivery, performance or suitability.

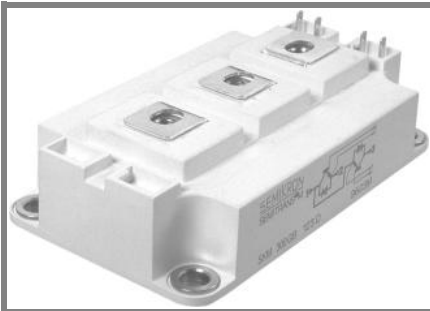

**SEMITRANS® 3**

## SPT IGBT Module

**SKM 300GB128D**

**SKM 300GAL128D**

### Features

- Homogeneous Si
- SPT = Soft-Punch-Through technology
- $V_{CEsat}$  with positive temperature coefficient
- High short circuit capability, self limiting to  $6 \times I_c$

### Typical Applications

- AC inverter drives
- UPS
- Electronic welders at  $f_{sw}$  up to 20 kHz

$Z_{th}$		Conditions	Values	Units
<b><math>Z_{th(j-c)I}</math></b>				
$R_{\theta j-c}$		$i = 1$	55	mk/W
$R_{\theta j-c}$		$i = 2$	26	mk/W
$R_{\theta j-c}$		$i = 3$	3,5	mk/W
$R_{\theta j-c}$		$i = 4$	0,5	mk/W
$\tau_{\theta j-c}$		$i = 1$	0,04	s
$\tau_{\theta j-c}$		$i = 2$	0,189	s
$\tau_{\theta j-c}$		$i = 3$	0,0017	s
$\tau_{\theta j-c}$		$i = 4$	0,003	s
<b><math>Z_{th(j-c)D}</math></b>				
$R_{\theta j-c}$		$i = 1$	120	mk/W
$R_{\theta j-c}$		$i = 2$	48	mk/W
$R_{\theta j-c}$		$i = 3$	10	mk/W
$R_{\theta j-c}$		$i = 4$	2	mk/W
$\tau_{\theta j-c}$		$i = 1$	0,0727	s
$\tau_{\theta j-c}$		$i = 2$	0,006	s
$\tau_{\theta j-c}$		$i = 3$	0,0078	s
$\tau_{\theta j-c}$		$i = 4$	0,0002	s

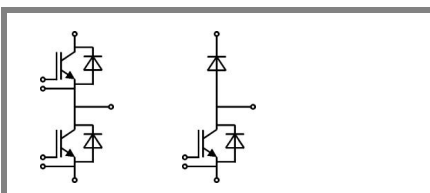

**GB**

**GAL**

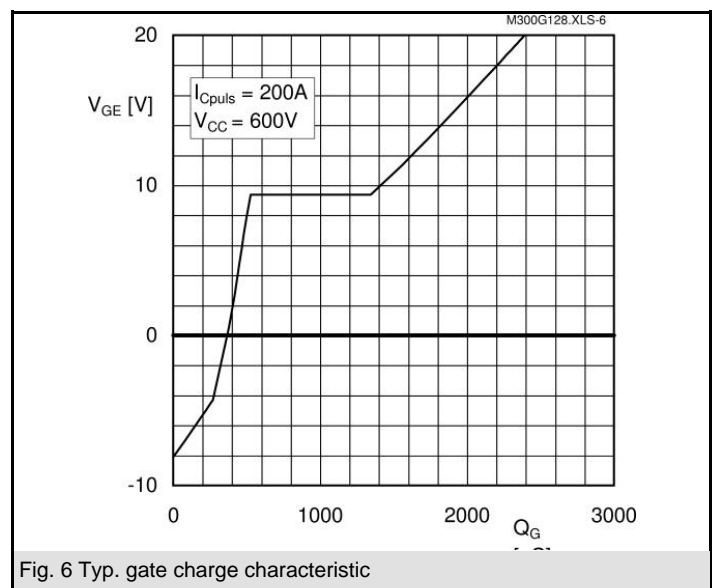
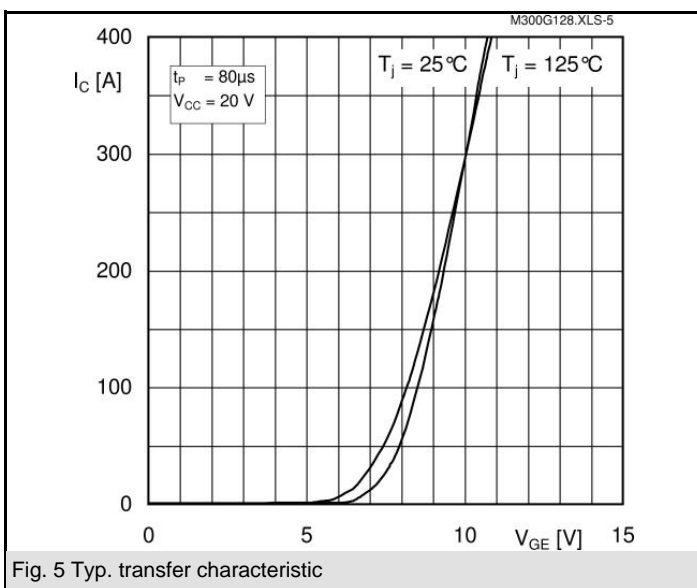
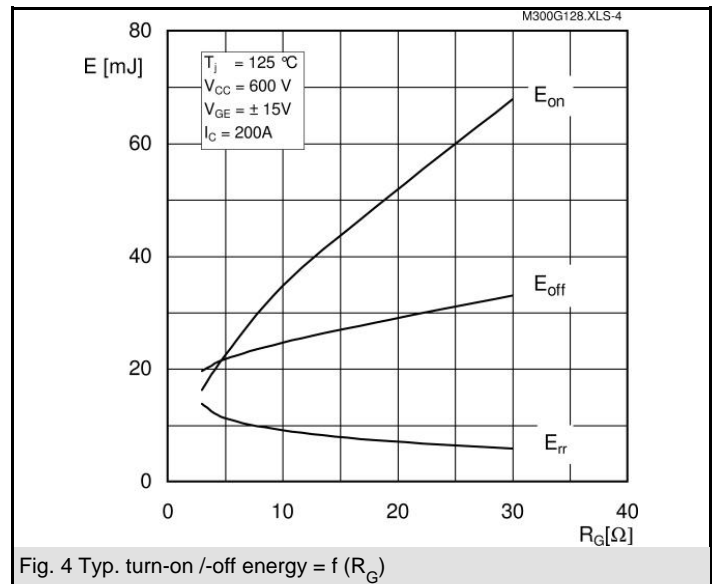
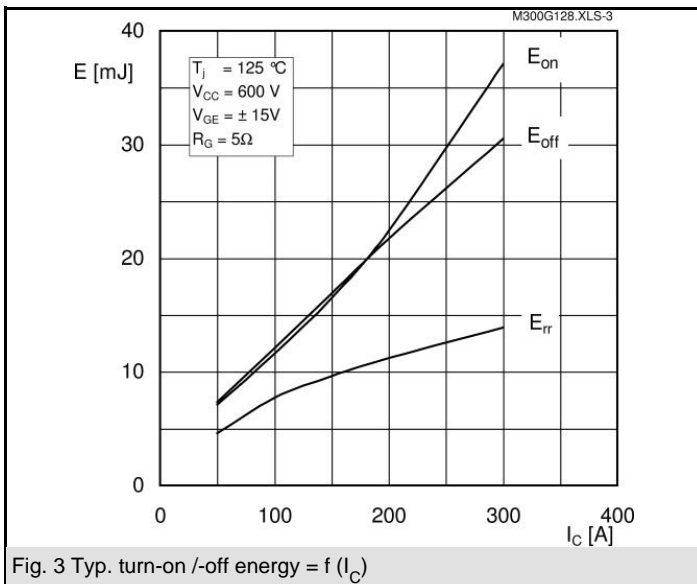
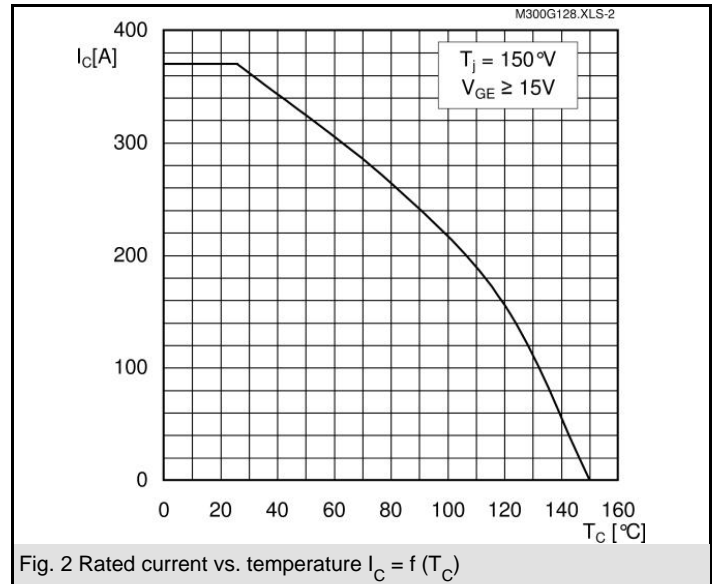
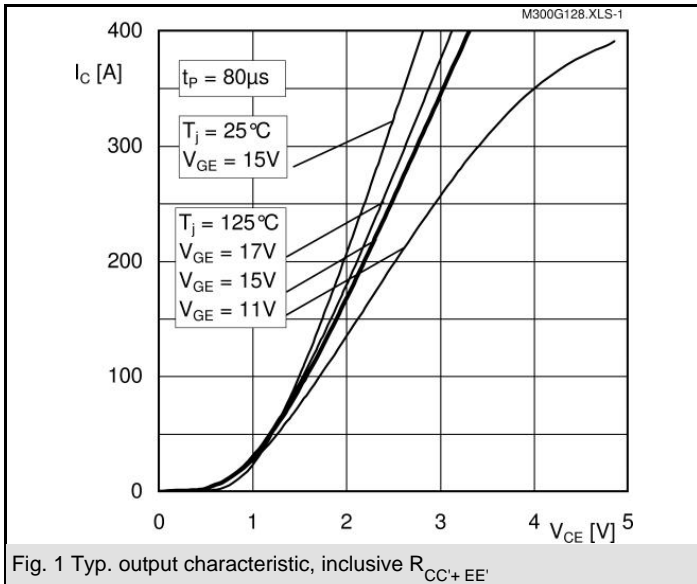

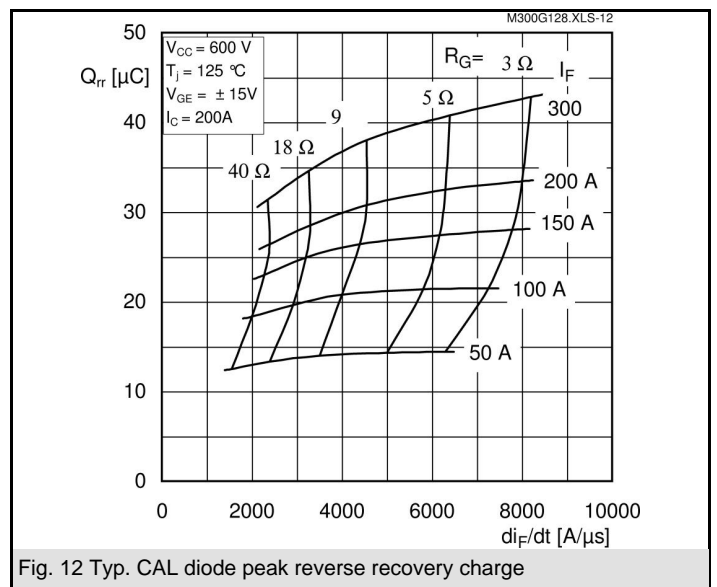
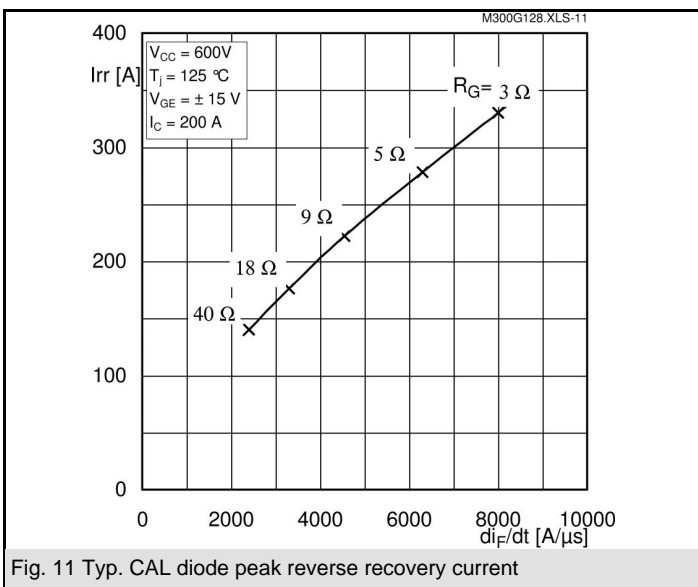
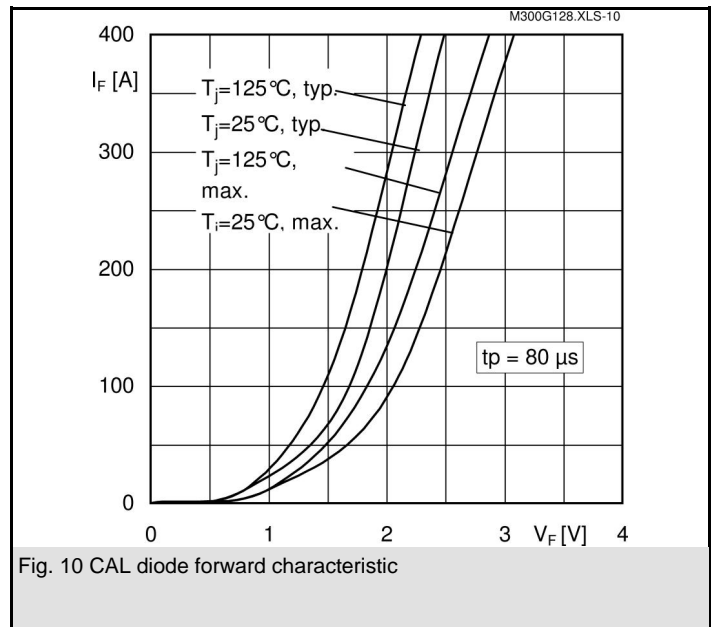
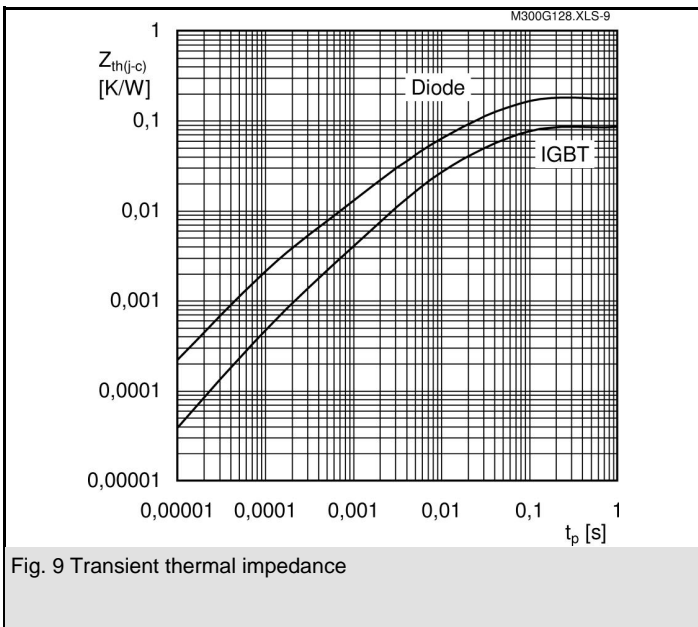
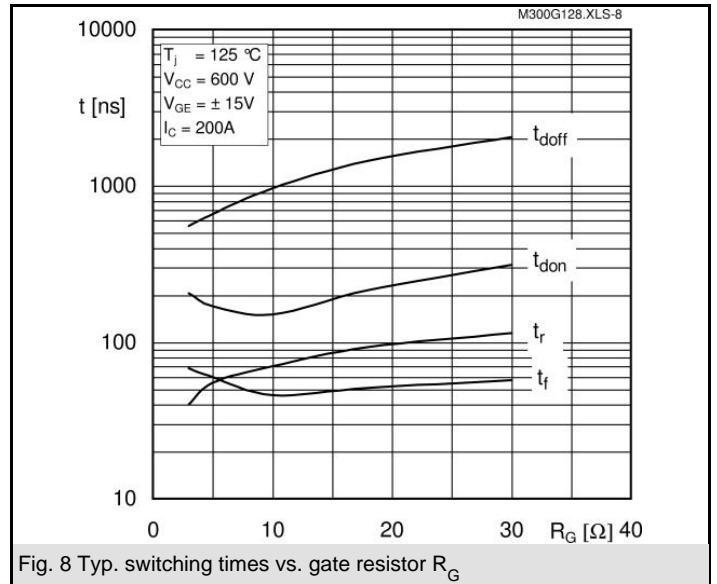
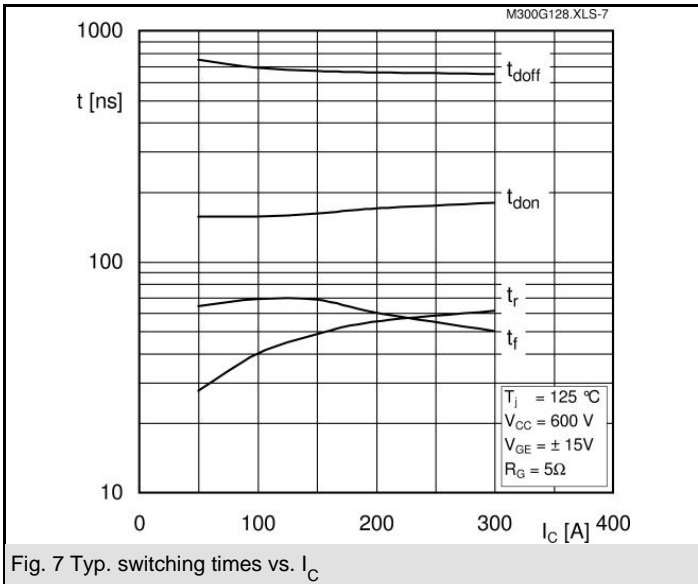

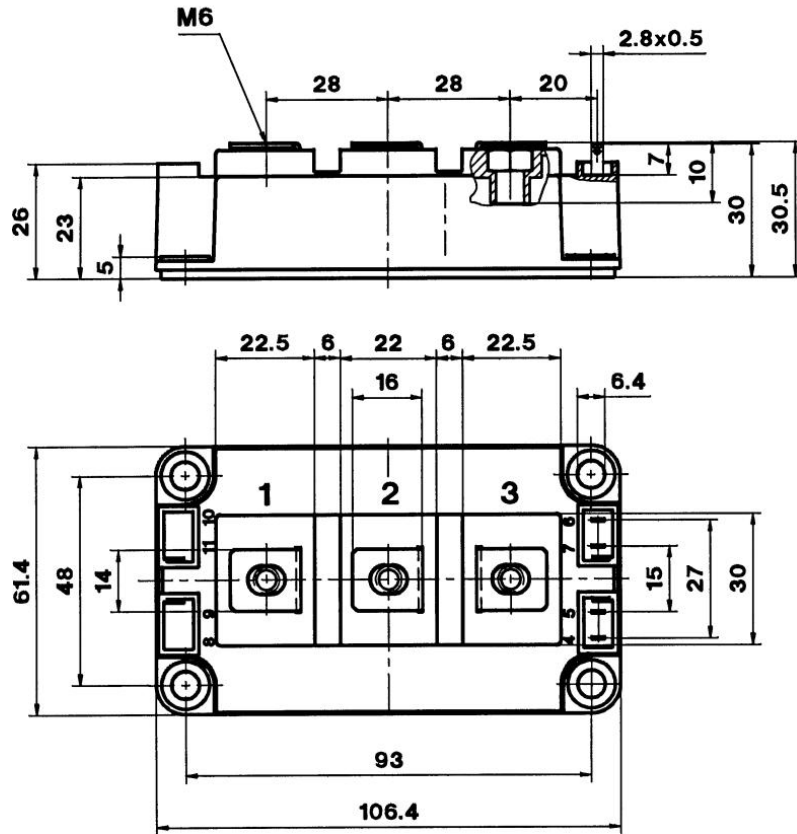

Case D 56

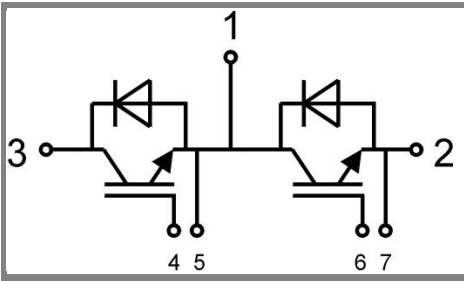

Case D56

GB

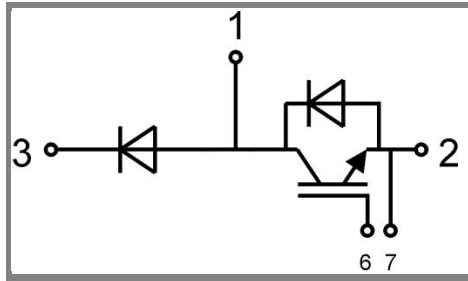

Case D57

GAL