

Infrared Receiver Control Receiver Module IRM-36xxT Series

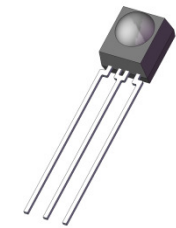

1 2 3

Pin Configuration

1. OUT
2. GND
3. V_{CC}

Block Diagram

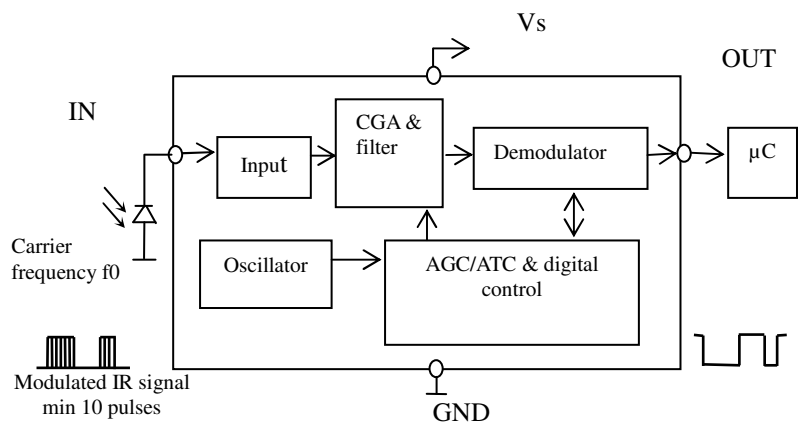

Features

- Photo detector and preamplifier in one package
- Internal filter for PCM frequency
- Improved inner shielding against electrical field disturbance
- TTL and CMOS compatibility
- Low power consumption
- Improved immunity against ambient light
- Suitable burst length ≥ 10 cycles/burst
- Pb free
- BiCMOS manufacture IC ; ESD HBM>4000V ; MM>250V
- The product itself will remain within RoHS compliant version.

Description

The IRM-36xxT is miniaturized receivers for infrared remote control systems. PIN diode and preamplifier are assembled on lead frame, the epoxy package is designed as IR filter. The demodulated output signal can directly be decoded by a microprocessor. IRM-36xxT is the standard IR remote control receiver series, supporting all major transmission codes.

Applications

- Light detecting portion of remote control
- AV instruments such as Audio, TV, VCR, CD, MD, etc.
- Home appliances such as Air-conditioner, Fan , etc.
- The other equipments with wireless remote control.
- CATV set top boxes
- Multi-media Equipment

Application Circuit

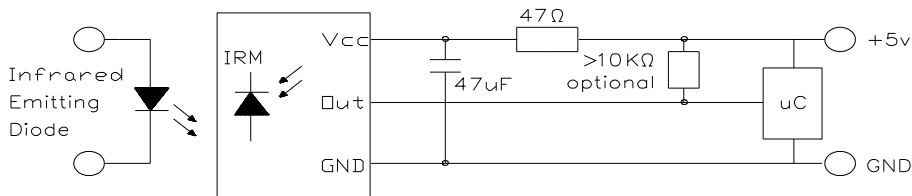

RC Filter should be connected closely between Vcc pin and GND pin.

Parts Table

Model No.	Carrier Frequency
IRM-3636T	36 kHz
IRM-3638T	38 kHz
IRM-3640T	40 kHz
IRM-3656T	56 kHz

Absolute Maximum Ratings (Ta=25°C)

Parameter	Symbol	Rating	Unit
Supply Voltage	Vcc	0~6	V
Operating Temperature	Topr	-20 ~ +80	°C
Storage Temperature	Tstg	-40 ~ +85	°C
Soldering Temperature *1	Tsol	260	°C

*1 4mm from mold body for less than 10 seconds

Recommended Operating Condition

Supply Voltage Rating: Vcc 2.7V to 5.5V

Electro-Optical Characteristics (Ta=25°C, and Vcc=3.0V)

Parameter	Symbol	Min.	Typ.	Max.	Unit	Condition
Current consumption	Icc	---	1.0	1.2	mA	No input signal
Peak wavelength	λ_p	---	940	---	nm	
Reception range	L_0	14	---	---	m	At the ray axis *1
	L_{45}	6	---	---		
Half angle(horizontal)	ϕ_h	---	45	---	deg	
Half angle(vertical)	ϕ_v	---	45	---	deg	
High level pulse width	T_H	400	---	800	μ s	At the ray axis *2
Low level pulse width	T_L	400	---	800	μ s	
High level output voltage	V_{OH}	2.7	---	---	V	
Low level output voltage	V_{OL}	---	---	0.25	V	

*1: The ray receiving surface at a vertex and relation to the ray axis in the range of $\theta = 0^\circ$ and $\theta = 45^\circ$.

*2: A range from 30cm to the arrival distance. Average value of 50 pulses.

Test method

The specified electro-optical characteristics is satisfied under the following Conditions at the controllable distance.

① Measurement place

A place that is nothing of extreme light reflected in the room.

② External light

Project the light of ordinary white fluorescent lamps which are not high Frequency lamps and must be less then 10 Lux at the module surface.
($E_e \leq 10 \text{Lux}$)

③ Standard transmitter

A transmitter whose output is so adjusted as to $V_o=400\text{mVp-p}$ and the output Wave form shown in Fig.-1. According to the measurement method shown in Fig.-2 the standard transmitter is specified.

However, the infrared photodiode to be used for the transmitter should be $\lambda_p=940\text{nm}, \Delta\lambda=50\text{nm}$. Also, photodiode is used of PD438B ($V_r=5\text{V}$).
(Standard light / Light source temperature 2856°K).

④ Measuring system

According to the measuring system shown in Fig.-3

Fig.-1 Transmitter Wave Form

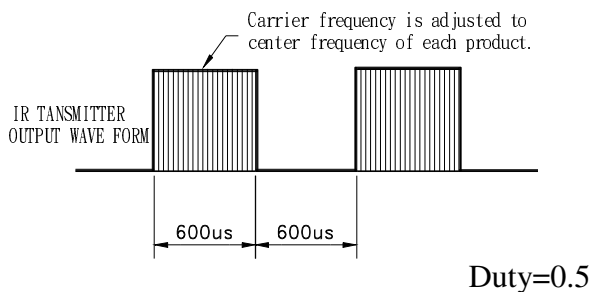

D.U.T output Pulse

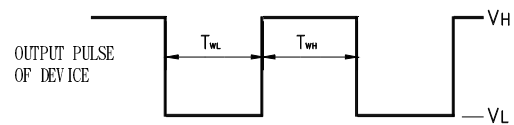

Fig.-2 Measuring Method

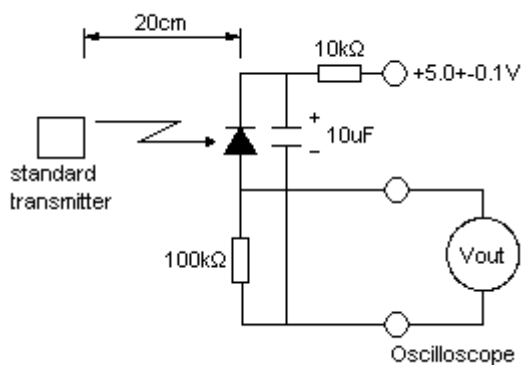
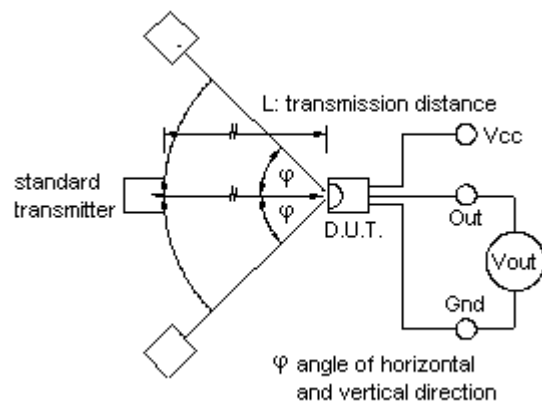

Fig.-3 Measuring System



The Notice of Application:

Transmission of remote control signal consist of four parts: Encode Part, IR Transmitter Source, IRM device, Decode Part

1. When IRM-36xxT code select frequency, it need to well understand the center system of encode part.
2. Strong or weak light of IR Transmitter can affect distance of transmission.
3. When using IRM-36xxT device, it requires the composition of code pattern to reach the demand as follows:

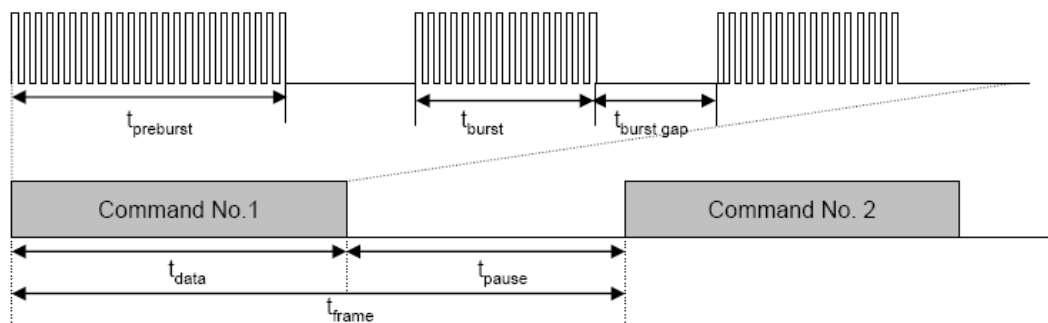

Minimum t_{burst} (number of pulses per burst)	Minimum t_{burst_gap} (number of pulses between two burst)	Minimum t_{pause}
10 pulses	14 pulses	25 msec

4. It needs to ensure the translation range of decode part if it is applied to the pulse-width range.

If the above items hardly assure of its application, it'll cause NG(no good) message from the edge of signal.

Typical Electro-Optical Characteristics Curves

Fig.-4 Relative Spectral Sensitivity vs. Wavelength

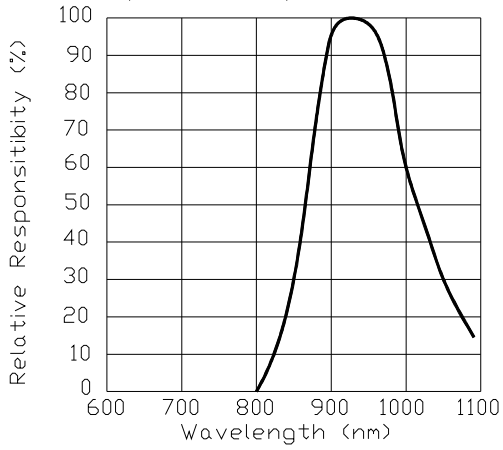

Fig.-5 Relative Transmission Distance vs. Direction

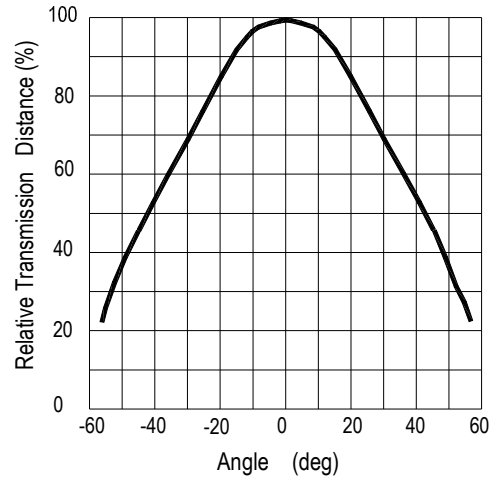

Fig.-6 Output Pulse Length vs. Arrival Distance

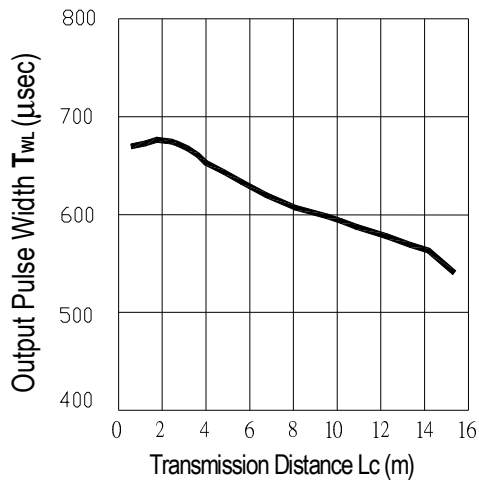

Fig.-7 Arrival Distance vs. Supply Voltage

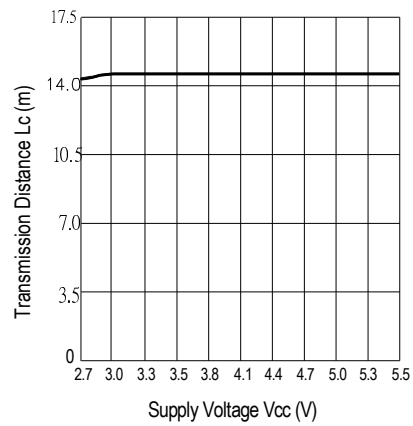

Fig.-8 Relative Transmission Distance vs. Center Carrier Frequency

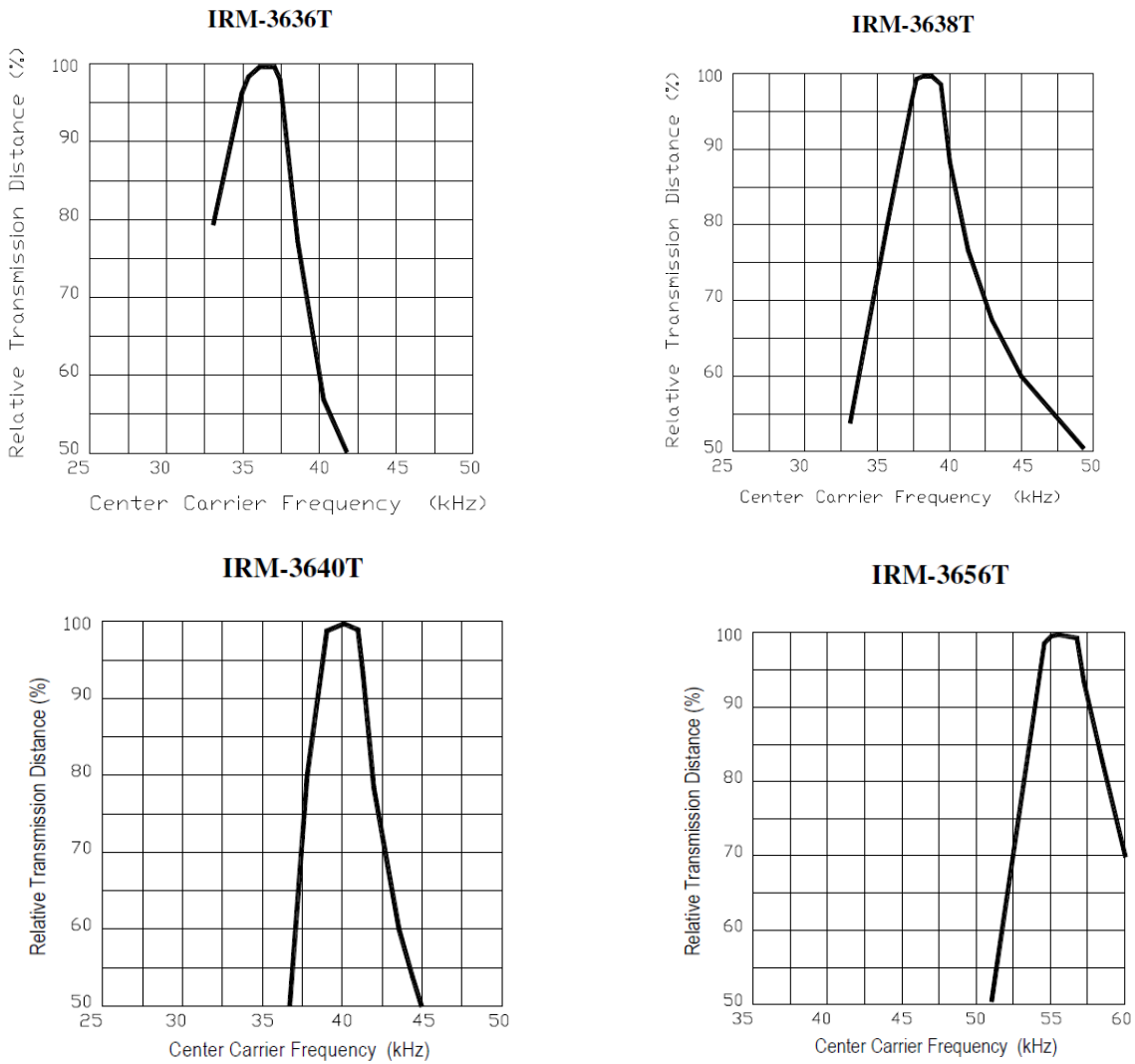
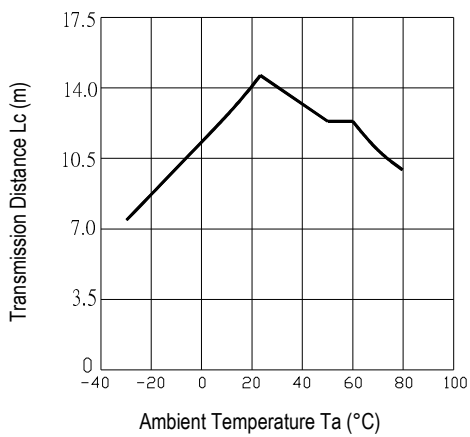
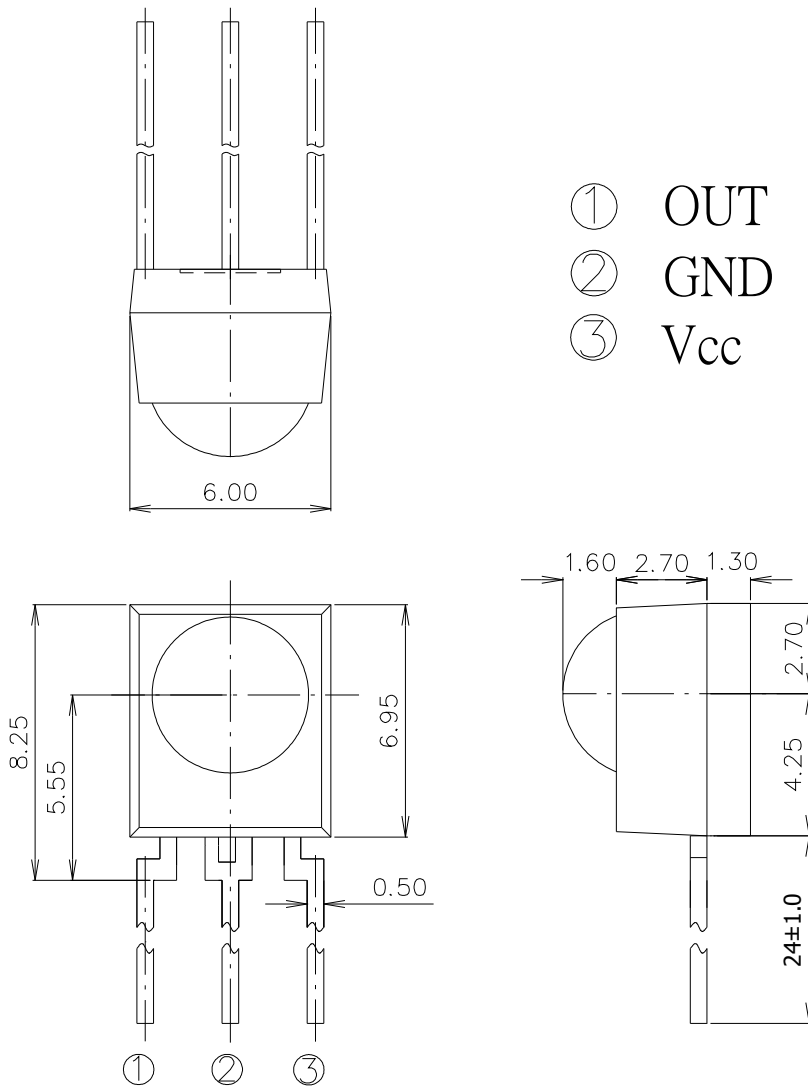

Fig.-9 Arrival Distance vs. Ambient Temperature



Package Dimensions



Unit:mm

Notes: 1.All dimensions are in millimeters. 0.4
2.Tolerances unless dimensions ± 0.3 mm.

Code information

Protocol	Suitable	Protocol	Suitable
NEC	Yes	Sony 12 Bit	Yes
RC5	Yes	Sony 15 Bit	No
RC6	Yes	Sony 20Bit	No
RCA	No	Matsushita	Yes
Toshiba	Yes	Mitsubishi	Yes
Sharp	Yes	Zenith	Yes
JVC	Yes	High data rate (4000 bit/s)	NO

Reliability Test Item And Condition

The reliability of products shall be satisfied with items listed below.

Confidence level : 90%

LTPD : 10%

Test Items	Test Conditions	Failure Judgement Criteria	<u>Samples(n)</u> Defective(c)
Temperature cycle	1 cycle $-40^{\circ}\text{C} \longleftrightarrow +100^{\circ}\text{C}$ (15min)(5min)(15min) 300 cycle test	$L_0 \leq L \times 0.8$ $L_{45} \leq L \times 0.8$ L: Lower specification limit	n=22,c=0
High temperature test	Temp: $+100^{\circ}\text{C}$ Vcc:6V 1000hrs		n=22,c=0
Low temperature storage	Temp: -40°C 1000hrs		n=22,c=0
High temperature High humidity	Ta: 85°C ,RH:85% 1000hrs		n=22,c=0
Solder heat	Temp: $260 \pm 5^{\circ}\text{C}$ 10sec 4mm From the bottom of the package.		n=22,c=0

Packing Quantity

1500 pcs / Box
10 Boxes / Carton

Label Form Specification

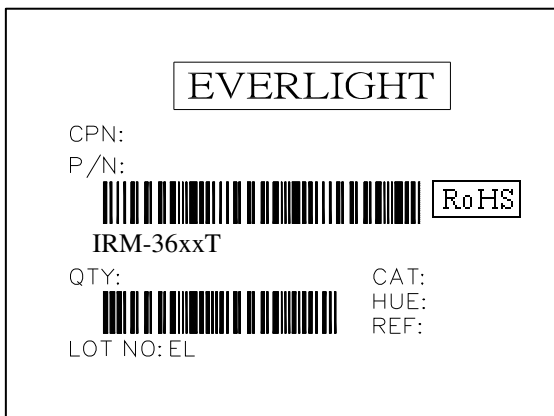

CPN: Customer's Production Number

P/N : Production Number

QTY: Packing Quantity

CAT: Ranks

HUE: None

REF: Reference

LOT No: Lot Number

MADE IN TAIWAN: Production Place

Application Restrictions

1. Above specification may be changed without notice. EVERLIGHT will reserve authority on material change for above specification.
2. When using this product, please observe the absolute maximum ratings and the instructions for use outlined in these specification sheets. EVERLIGHT assumes no responsibility for any damage resulting from use of the product which does not comply with the absolute maximum ratings and the instructions included in these specification sheets.
3. These specification sheets include materials protected under copyright of EVERLIGHT. Reproduction in any form is prohibited without the specific consent of EVERLIGHT.

Mouser Electronics

Authorized Distributor

Click to View Pricing, Inventory, Delivery & Lifecycle Information:

[Everlight:](#)

[IRM-3636T](#) [IRM-3638T](#) [IRM-3640T](#) [IRM-3656T](#)