

## P-Channel Enhancement Mode Field Effect Transistor

### FEATURES

- -60V, -2.4A,  $R_{DS(ON)} = 135m\Omega$  @  $V_{GS} = -10V$ .  
 $R_{DS(ON)} = 180m\Omega$  @  $V_{GS} = -4.5V$ .
- High dense cell design for extremely low  $R_{DS(ON)}$ .
- Rugged and reliable.
- Lead free product is acquired.
- SOT-89 package.

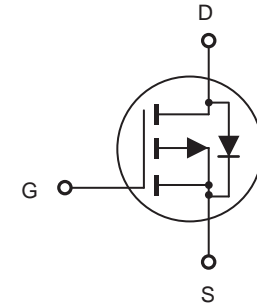

### ABSOLUTE MAXIMUM RATINGS $T_A = 25^\circ\text{C}$ unless otherwise noted

Parameter	Symbol	Limit	Units
Drain-Source Voltage	$V_{DS}$	-60	V
Gate-Source Voltage	$V_{GS}$	$\pm 20$	V
Drain Current-Continuous	$I_D$	-2.4	A
Drain Current-Pulsed <sup>a</sup>	$I_{DM}$	-10	A
Maximum Power Dissipation	$P_D$	1.25	W
Operating and Store Temperature Range	$T_J, T_{stg}$	-55 to 150	$^\circ\text{C}$

### Thermal Characteristics

Parameter	Symbol	Limit	Units
Thermal Resistance, Junction-to-Ambient <sup>b</sup>	$R_{\theta JA}$	100	$^\circ\text{C/W}$

## Electrical Characteristics $T_C = 25^\circ\text{C}$ unless otherwise noted

Parameter	Symbol	Test Condition	Min	Typ	Max	Units
<b>Off Characteristics</b>						
Drain-Source Breakdown Voltage	$BV_{DSS}$	$V_{GS} = 0V, I_D = -250\mu A$	-60			V
Zero Gate Voltage Drain Current	$I_{DSS}$	$V_{DS} = -60V, V_{GS} = 0V$			-1	$\mu A$
Gate Body Leakage Current, Forward	$I_{GSSF}$	$V_{GS} = 20V, V_{DS} = 0V$			100	nA
Gate Body Leakage Current, Reverse	$I_{GSSR}$	$V_{GS} = -20V, V_{DS} = 0V$			-100	nA
<b>On Characteristics<sup>b</sup></b>						
Gate Threshold Voltage	$V_{GS(th)}$	$V_{GS} = V_{DS}, I_D = -250\mu A$	-1		-3	V
Static Drain-Source On-Resistance	$R_{DS(on)}$	$V_{GS} = -10V, I_D = -2.4A$		105	135	$m\Omega$
		$V_{GS} = -4.5V, I_D = -1.9A$		135	180	$m\Omega$
<b>Dynamic Characteristics<sup>c</sup></b>						
Input Capacitance	$C_{iss}$	$V_{DS} = -30V, V_{GS} = 0V,$ $f = 1.0\text{ MHz}$		890		$\mu F$
Output Capacitance	$C_{oss}$			90		$\mu F$
Reverse Transfer Capacitance	$C_{rss}$			85		$\mu F$
<b>Switching Characteristics<sup>c</sup></b>						
Turn-On Delay Time	$t_{d(on)}$	$V_{DD} = -30V, I_D = -1A,$ $V_{GS} = -10V, R_{GEN} = 6\Omega$		13	26	ns
Turn-On Rise Time	$t_r$			5	10	ns
Turn-Off Delay Time	$t_{d(off)}$			39	78	ns
Turn-Off Fall Time	$t_f$			13	26	ns
Total Gate Charge	$Q_g$	$V_{DS} = -30V, I_D = -2.4A,$ $V_{GS} = -10V$		11.2	14.8	nC
Gate-Source Charge	$Q_{gs}$			2.6		nC
Gate-Drain Charge	$Q_{gd}$			1.8		nC
<b>Drain-Source Diode Characteristics and Maximum Ratings</b>						
Drain-Source Diode Forward Current	$I_S$				-2.4	A
Drain-Source Diode Forward Voltage <sup>b</sup>	$V_{SD}$	$V_{GS} = 0V, I_S = -1.3A$			-1.2	V
<b>Notes :</b> a.Repetitive Rating : Pulse width limited by maximum junction temperature. b.Pulse Test : Pulse Width $\leq 300\mu s$ , Duty Cycle $\leq 2\%$ . c.Guaranteed by design, not subject to production testing.						

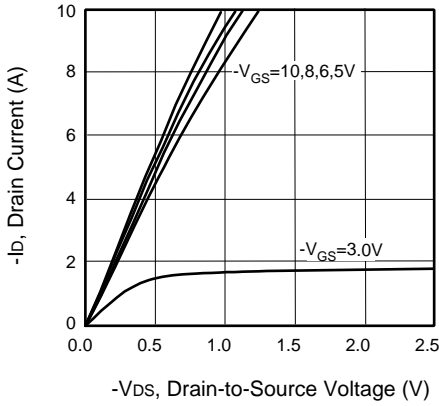

**Figure 1. Output Characteristics**

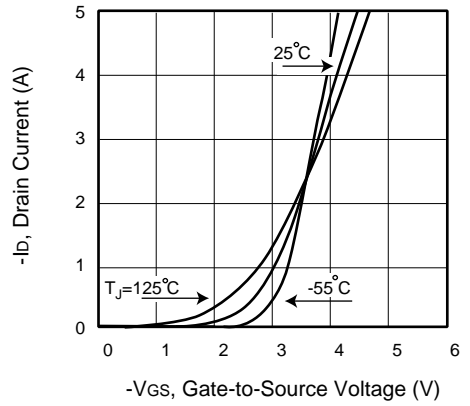

**Figure 2. Transfer Characteristics**

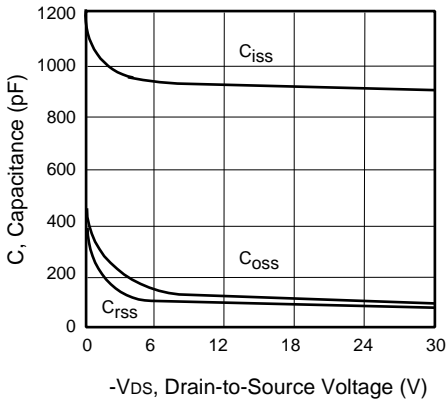

**Figure 3. Capacitance**

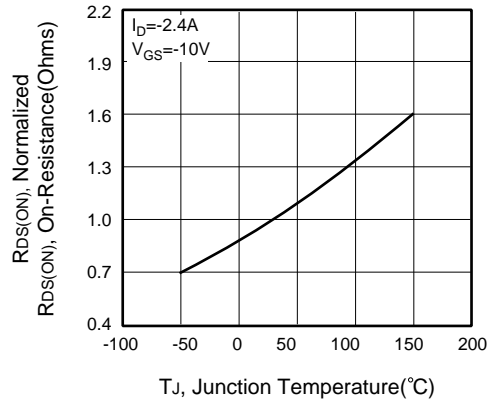

**Figure 4. On-Resistance Variation with Temperature**

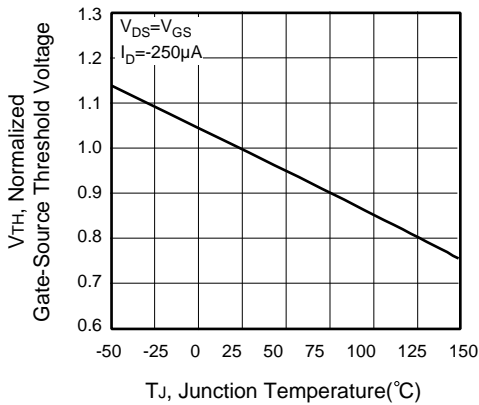

**Figure 5. Gate Threshold Variation with Temperature**

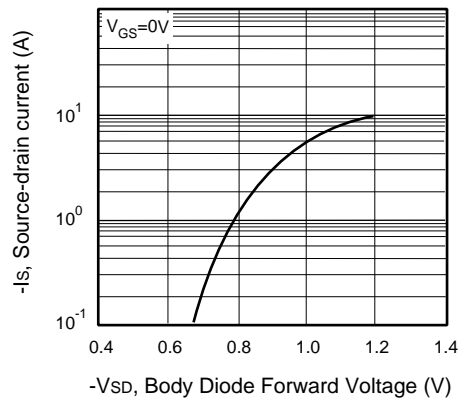

**Figure 6. Body Diode Forward Voltage Variation with Source Current**

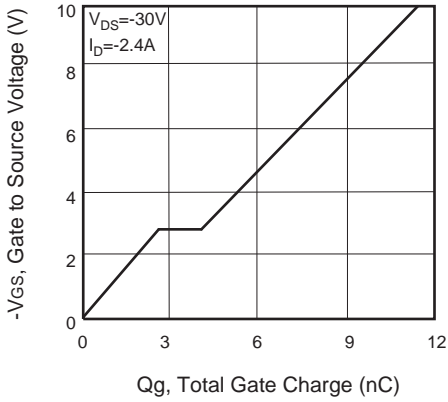

Figure 7. Gate Charge

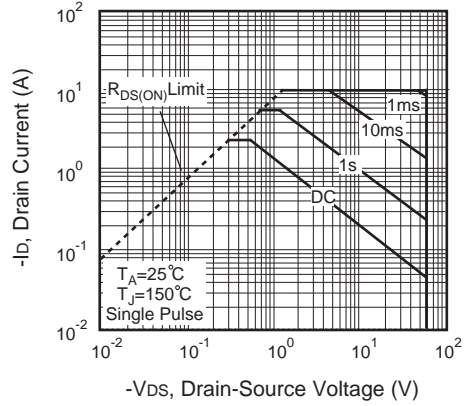

Figure 8. Maximum Safe Operating Area

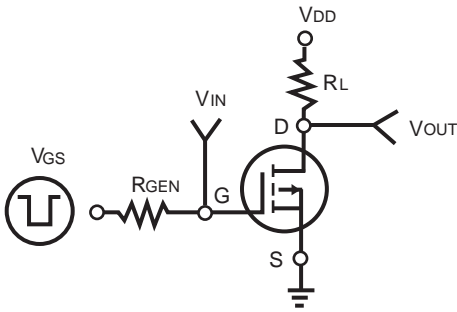

Figure 9. Switching Test Circuit



Figure 10. Switching Waveforms

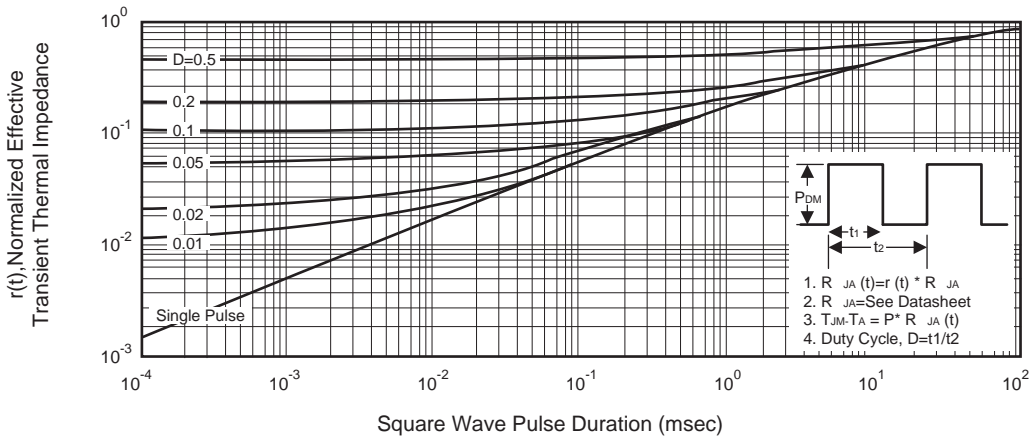

Figure 11. Normalized Thermal Transient Impedance Curve