

DARLINGTON ARRAY DRIVER IC

DESCRIPTION

The ULN2003 is high-voltage, high-current darlington driver IC composed of 7 NPN darlington pairs. All units share the emitter in common, and each unit adopts open-collector output. A 2.7KΩ resistor is connected to each darlington pair in serial, which is compatible with TTL and 5V CMOS for data processing without logic buffer.

Sink current of ULN2003 is up to 500mA, when it is off state, the withstand voltage is 50V and the output can runs with high load current, which provides solutions for various interface.

FEATURES

- ◆ Wide operating voltage range
- ◆ 7-ch darlington array
- ◆ High output voltage (up to 50V)
- ◆ High output current (up to 500mA)
- ◆ Able to connect to TTL, CMOS, PMOS directly
- ◆ Clamp diodes for switching inductive loads

APPLICATIONS

- ◆ Relay driver
- ◆ DC lamp driver
- ◆ Step motor driver
- ◆ Magnet valve
- ◆ DC brushless motor driver

ORDERING INFORMATION

Part No.	Package	Marking	Hazardous	Packing
ULN2003AN	DIP-16-300-2.54	ULN2003AN	Halogen free	Tube
ULN2003A	SOP-16-225-1.27	ULN2003A	Halogen free	Tape&reel

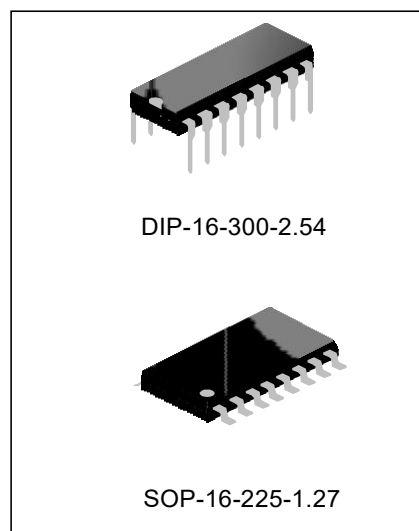

BOLBK DIAGRAM

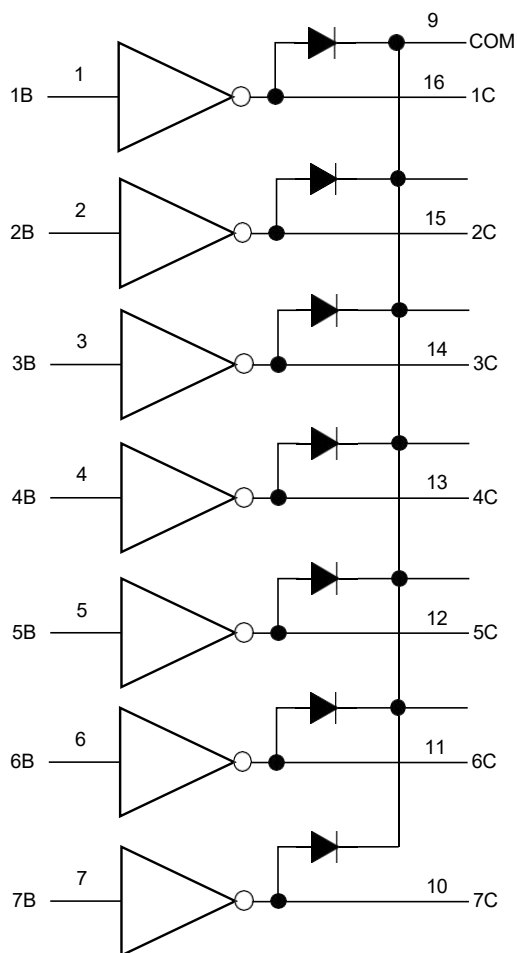

DARLINGTON ARRAY DRIVER IC

ABSOLUTE MAXIMUM RATINGS

Parameter	Symbol	Ratings	Units
Input Voltage	V_{IN}	-0.5~30	V
Output Voltage	V_{OUT}	-0.5~50	V
clamp Diode Reverse Voltage	V_R	50	V
Output Current	I_{OUT}	500	mA
Clamp Diode Forward Current	I_F	25	mA
Storage Temperature	T_{STG}	-55~150	°C
Operating Temperature	T_{OPR}	-40~85	°C
Operating Junction Temperature	T_J	-40~150	°C

ELECTRICAL CHARACTERISTICS (Ta = 25°C unless otherwise noted)

Parameter	Symbol	Test conditions	Min.	Typ.	Max.	Units
Output Leakage Current	I_{CEX}	$T_A=25^{\circ}C, V_{CE}=50V$ (Figure 1)			20	uA
		$T_A=85^{\circ}C, V_{CE}=50V$ (Figure 1)			100	
CE Saturation Voltage	$V_{CE(sat)}$	$I_{OUT}=350mA, I_{IN}=500\text{ uA}$ (Figure 3)		1.3	1.6	V
		$I_{OUT}=250mA, I_{IN}=350\text{ uA}$ (Figure 3)		1.1	1.3	
		$I_{OUT}=100mA, I_{IN}=250\text{ uA}$ (Figure 3)		0.9	1.1	
Input Current (Output On)	$I_{I(ON)}$	$V_I=3.85V$ (Figure 4)		0.93	1.35	mA
Input Current (Output Off)	$I_{I(OFF)}$	$I_C=500\text{uA}$ (Figure 5)	50	100		uA
		$T_A=+25^{\circ}C$	50	100		
		$T_A=+85^{\circ}C$	25	50		
Input Voltage (Output On)	$V_{I(ON)}$	$V_{CE}=2.0V, I_C=200mA$ (Figure 6)			2.4	V
		$V_{CE}=2.0V, I_C=250mA$ (Figure 6)			2.7	
		$V_{CE}=2.0V, I_C=300mA$ (Figure 6)			3.0	
Input Capacitance	C_i			15	30	pF
Turn-on Delay	t_{MH}	$0.5V_I$ to $0.5V_O$			1.0	μS
Turn-off Delay	t_{ML}	$0.5V_I$ to $0.5V_O$			1.0	
Clamp Diode Reverse Current	I_R	$V_R=50V$ (Figure 7)				μA
		$T_A=+25^{\circ}C$		5	10	
		$T_A=+85^{\circ}C$		10	50	
Clamp Diode Forward Voltage	V_F	$I_F=350mA$ (Figure 8)		1.7	2.0	V

Notes: 1. Absolute maximum ratings are those values beyond which the device could be permanently damaged.

Absolute maximum ratings are stress ratings only and functional device operation is not implied. Electrical Characteristics are for normal operating range;

2. All the conditions are suitable for darlington pairs unless otherwise noted;

3. In general, with 70°C, VCE (Sat)= 1.6V, pulse width=20ms, the continuous operating current of each channel is 350mA.

TYPICAL CHARACTERISTIC CURVES

Figure 1. Collector Current vs. Saturation Voltage Drop

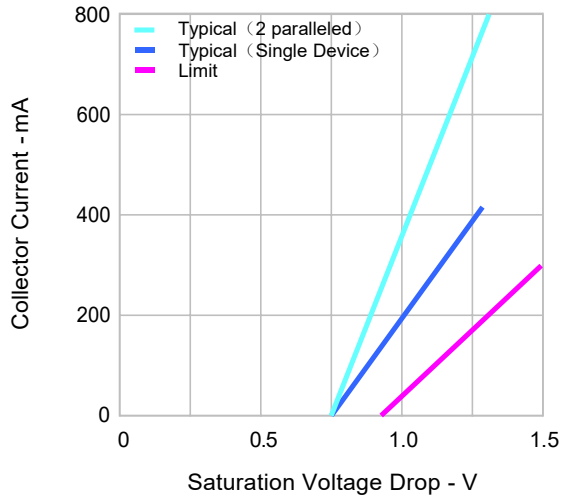

Figure 2. Collector Current vs. Input Current

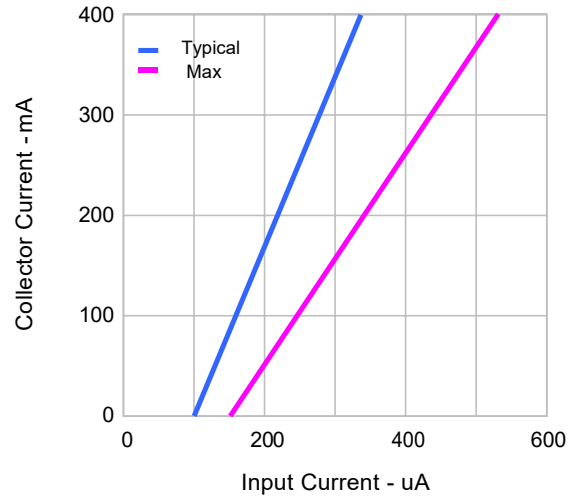

Figure 3. Input Current vs. Input Voltage

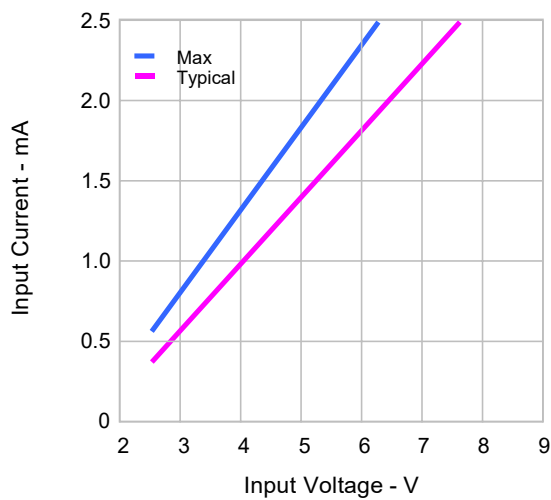
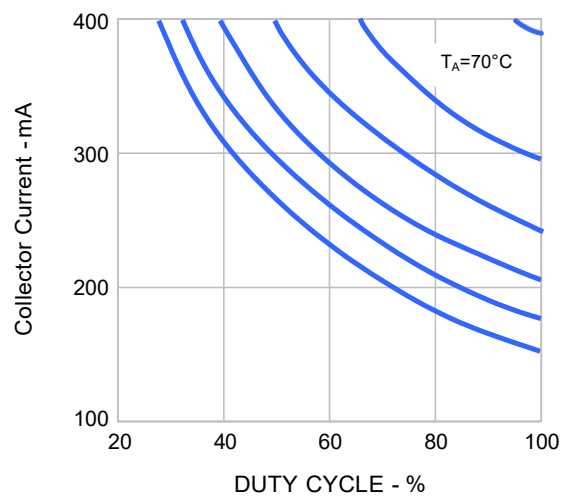
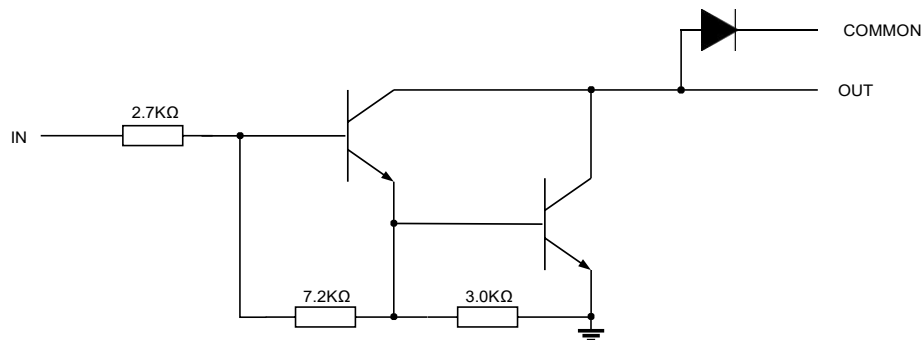

Figure 4. Collector Current vs. Duty Cycle



INTERNAL EQUIVALENT CIRCUIT



TEST CIRCUITS

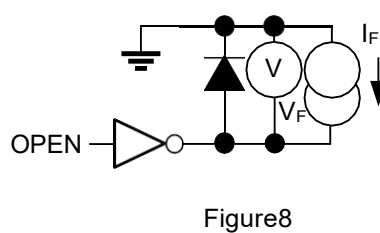
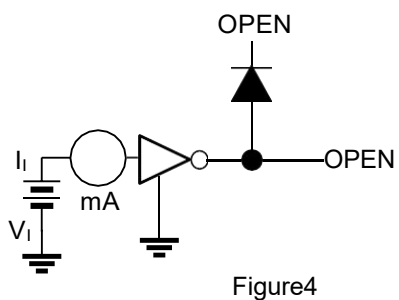
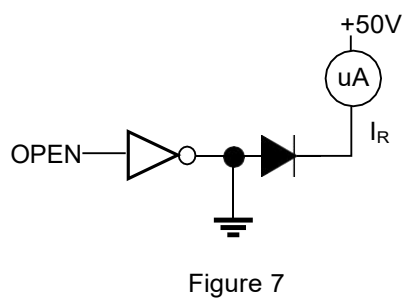
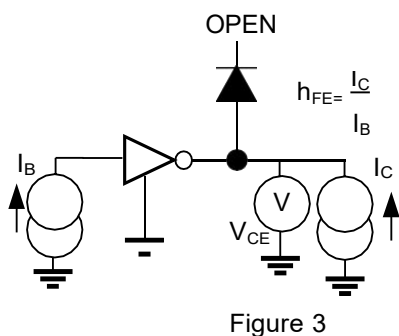
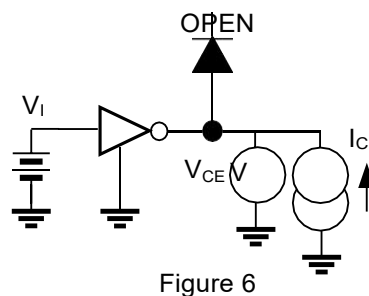
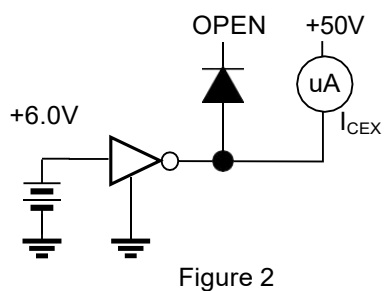
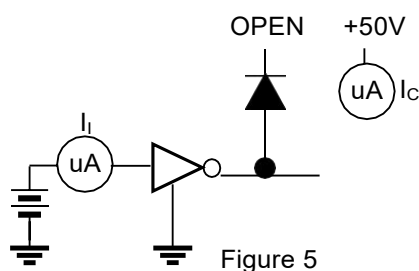
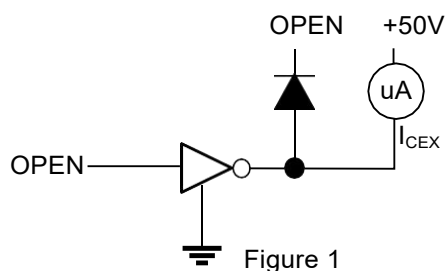

PACKAGE OUTLINE

DARLINGTON ARRAY DRIVER IC

DIP-16-300-2.54

UNIT: mm

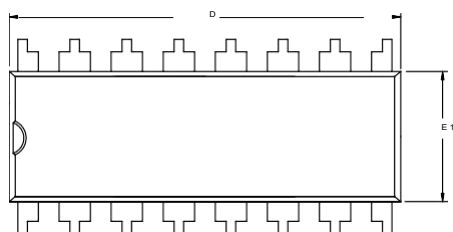
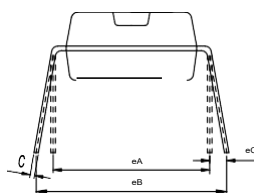
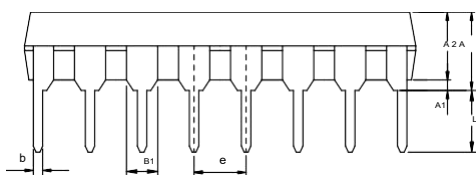

SYMBOL	MILLIMETER		
	MIN	NOM	MAX
A			4.45
A1	0.50		—
A2	3.20		3.70
b	0.38	0.46	0.54
B1	1.52BSC		
c	0.20		0.35
D	18.90		19.45
E1	6.15		6.60
e	2.54BSC		
eA	7.62BSC		
eB	7.62		9.30
eC	0		1.52
L	3.00	—	—

SOP-16-225-1.27

UNIT: mm

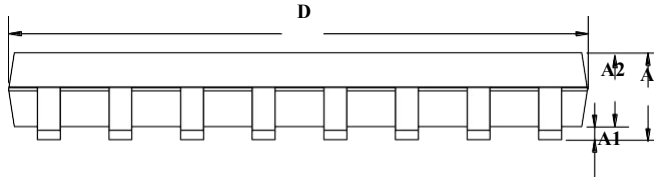
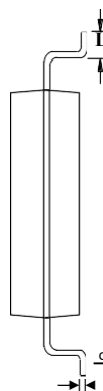
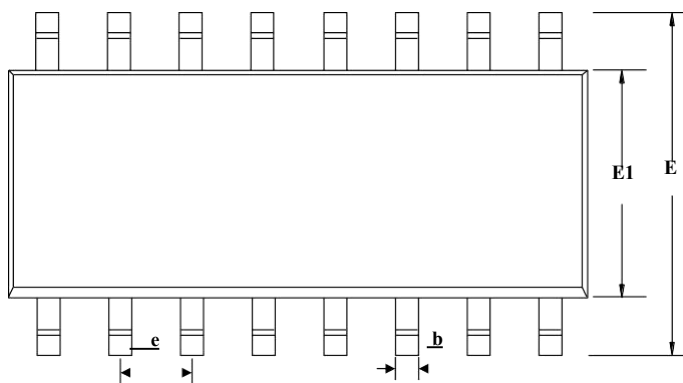

SYMBOL	MILLIMETER		
	MIN	NOM	MAX
A	—	—	1.80
A1	0.10	0.15	0.25
A2	1.25	1.45	1.65
b	0.33	—	0.51
c	0.17	—	0.25
D	9.50	—	10.20
E	5.80	6.00	6.20
E1	3.70	—	4.10
e	1.27BSC		
L	0.45	0.60	0.80