

## Description

The LM2576 series of regulators are monolithic integrated circuits that provide all the active functions for a step-down (buck) switching regulator, capable of driving 3A load with excellent line and load regulation. These devices are available in fixed output voltages of 3.3V, 5V, 12V, 15V, and an adjustable output versions. Requiring a minimum number of external components, these regulators are simple to use and include internal frequency compensation and a fixed-frequency oscillator. The LM2576 series offers a high-efficiency replacement for popular three-terminal linear regulators. It substantially reduces the size of the heat sink, and in some cases no heat sink is required. A standard series of inductors optimized for use with the LM2576 are available from several different manufacturers. This feature greatly simplifies the design of switch-mode power supplies. Other features include a guaranteed  $\pm 4\%$  tolerance on output voltage within specified input voltages and output load conditions, and  $\pm 10\%$  on the oscillator frequency. External shutdown is included, featuring 50 $\mu$ A (typical) standby current. The output switch includes cycle-by-cycle current limiting, as well as thermal shutdown for full protection under fault conditions.

Note: The LM2576HV is not produced yet.

## Features

- 3.3V, 5V, 12V, 15V, and adjustable output versions
- Adjustable version output voltage range
- 1.23V to 37V (57V for HV version)  $\pm 4\%$  max over line and load conditions
- Guaranteed 3A output current
- Wide input voltage range, 40V up to 57V for HV version
- Requires only 4 external components
- 52 kHz fixed frequency oscillator
- TTL shutdown capability, low power standby mode
- High efficiency
- Uses readily available standard inductors
- Thermal shutdown and current limit protection

## Applications

- Simple high-efficiency step-down (buck) regulator
- Efficient pre-regulator for linear regulators
- On-card switching regulators
- Positive to negative converter (Buck-Boost)

**Typical application** Figure 1.(Fixed Output Voltage Versions)

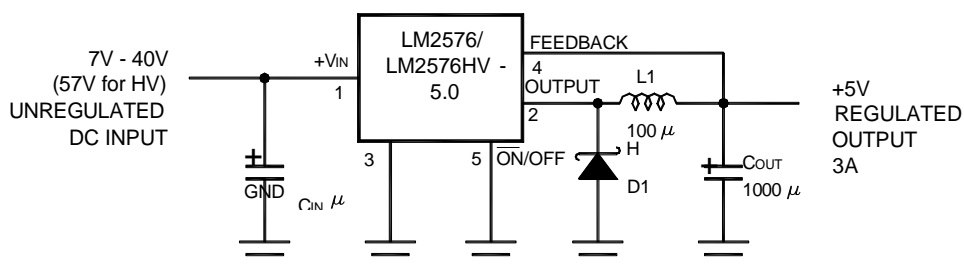

## Package Types

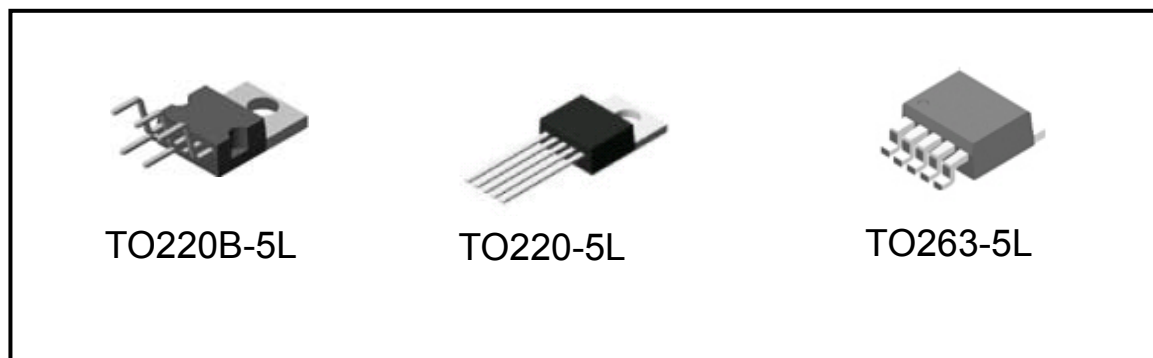

## Pin Assignments

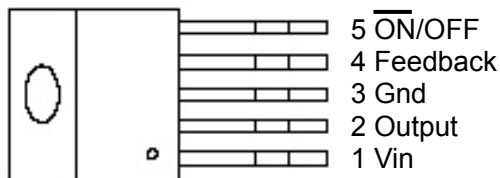

TO220B-5L/TO220-5L



TO263-5L

## Pin Descriptions

Name	Description
Vin	Input supply voltage
Output	Switching output
Gnd	Ground
Feedback	Output voltage feedback
ON/OFF	ON/OFF shutdown Active is "Low" or floating

## Block Diagram

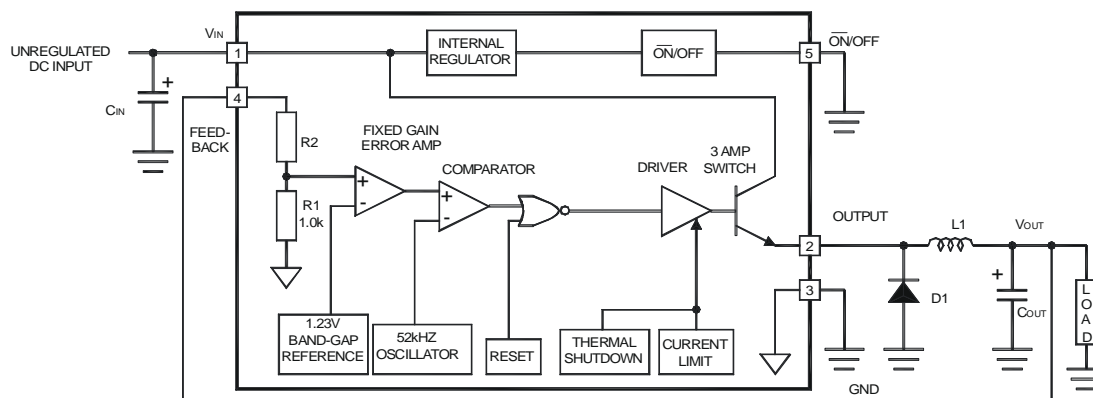

3.3V, R2 = 1.7K  
 5V, R2 = 3.1K  
 12V, R2 = 8.84K  
 15V, R2 = 11.3K  
 For ADJ, Version  
 R1 = Open, R2 = 0Ω

## Ordering information

Temperature Range	Output Voltage, V					Package Type
	3.3	5.0	12	15	ADJ	
-40°C ≤ T <sub>A</sub> ≤ 125°C	LM2576HVS -3.3	LM2576HVS -5.0	LM2576HVS -12	LM2576HVS -15	LM2576HVS -ADJ	TO-263
	LM2576S -3.3	LM2576S -5.0	LM2576S -12	LM2576S -15	LM2576S -ADJ	
	LM2576HVT -3.3	LM2576HVT -5.0	LM2576HVT -12	LM2576HVT -15	LM2576HVT -ADJ	TO-220
	LM2576T -3.3	LM2576T -5.0	LM2576T -12	LM2576T -15	LM2576T -ADJ	

## Absolute Maximum Ratings (Note 1)

Parameter	Maximum	Units
Maximum Supply Voltage LM2576 LM2576HV	45 57	V
ON/OFF Pin Input Voltage	$-0.3V \leq V \leq +V_{IN}$	
Output Voltage to Ground (Steady State)	-1	V
Power Dissipation	Internally Limited	W
Storage Temperature Range	-65 to +150	°C
Maximum Junction Temperature	150	°C
Minimum ESD Rating (C= 100pF, R = 1.5 kΩ)	2	kV
Lead Temperature (Soldering, 10 Seconds)	260	°C

## Operating Ratings

Parameter	Value	Units
Temperature Range LM2576/LM2576HV	$-40 \leq T_J \leq +125$	°C
Supply Voltage LM2576 LM2576HV	40 57	V

## Electrical Characteristics LM2576- 3.3,LM2576HV -3.3

Specifications with standard type face are for  $T_J = 25^\circ\text{C}$ , and those with **boldface type** apply over full Operating Temperature Range.

Symbol	Parameter	Conditions	LM2576 -3.3 LM2576HV -3.3		Units (Limits)
			Typ	Limit (Note 2)	
<b>SYSTEM PARAMETERS (Note 3) Test Circuit Figure 2</b>					
$V_{OUT}$	Output Voltage	$V_{IN} = 12V, I_{LOAD} = 0.5A$ Circuit of Figure 2	3.3	3.234 3.366	V V(Min) V(Max)
$V_{OUT}$	Output Voltage MIK2576	$6V \leq V_{IN} \leq 40V, 0.5A \leq I_{LOAD} \leq 3A$ Circuit of Figure 2	3.3	3.168/ <b>3.135</b> 3.432/ <b>3.465</b>	V V(Min) V(Max)
$V_{OUT}$	Output Voltage MIK2576HV	$6V \leq V_{IN} \leq 60V, 0.5A \leq I_{LOAD} \leq 3A$ Circuit of Figure 2	3.3	3.168/ <b>3.135</b> 3.450/ <b>3.482</b>	V V(Min) V(Max)
$\eta$	Efficiency	$V_{IN} = 12V, I_{LOAD} = 3A$	75		%

## Electrical Characteristics LM2576 -5.0,LM2576HV-5.0

Specifications with standard type face are for  $T_J = 25^\circ\text{C}$ , and those with **boldface type** apply over full Operating Temperature Range.

Symbol	Parameter	Conditions	LM2576 -5.0 LM2576HV -5.0		Units (Limits)
			Typ	Limit (Note 2)	
<b>SYSTEM PARAMETERS (Note 3) Test Circuit Figure 2</b>					
$V_{OUT}$	Output Voltage	$V_{IN} = 12V, I_{LOAD} = 0.5A$ Circuit of Figure 2	5.0	4.900 5.100	V V(Min) V(Max)
$V_{OUT}$	Output Voltage MIK2576	$0.5A \leq I_{LOAD} \leq 3A,$ $8V \leq V_{IN} \leq 40V$ Circuit of Figure 2	5.0	4.800/ <b>4.750</b> 5.200/ <b>5.250</b>	V V(Min) V(Max)
$V_{OUT}$	Output Voltage MIK2576HV	$0.5A \leq I_{LOAD} \leq 3A,$ $8V \leq V_{IN} \leq 60V$ Circuit of Figure 2	5.0	4.800/ <b>4.750</b> 5.225/ <b>5.275</b>	V V(Min) V(Max)
$\eta$	Efficiency	$V_{IN} = 12V, I_{LOAD} = 3A$	77		%

## Electrical Characteristics LM2576 -12, LM2576HV -12

Specifications with standard type face are for  $T_J = 25^\circ\text{C}$ , and those with **boldface type** apply over full Operating Temperature Range.

Symbol	Parameter	Conditions	LM2576 -12 LM2576HV -12		Units (Limits)
			Typ	Limit(Note 2)	
<b>SYSTEM PARAMETERS (Note 3) Test Circuit Figure 2</b>					
$V_{OUT}$	Output Voltage	$V_{IN} = 25\text{V}$ , $I_{LOAD} = 0.5\text{A}$ Circuit of Figure 2	12	11.76 12.24	V V(Min) V(Max)
$V_{OUT}$	Output Voltage MIK2576	$0.5\text{A} \leq I_{LOAD} \leq 3\text{A}$ , $15\text{V} \leq V_{IN} \leq 40\text{V}$ Circuit of Figure 2	12	11.52/ <b>11.40</b> 12.48/ <b>12.60</b>	V V(Min) V(Max)
$V_{OUT}$	Output Voltage MIK2576HV	$0.5\text{A} \leq I_{LOAD} \leq 3\text{A}$ , $15\text{V} \leq V_{IN} \leq 60\text{V}$ Circuit of Figure 2	12	11.52/ <b>11.40</b> 12.54/ <b>12.66</b>	V V(Min) V(Max)
$\eta$	Efficiency	$V_{IN} = 15\text{V}$ , $I_{LOAD} = 3\text{A}$	88		%

## Electrical Characteristics LM2576 -15, LM2576HV -15

Specifications with standard type face are for  $T_J = 25^\circ\text{C}$ , and those with **boldface type** apply over full Operating Temperature Range.

Symbol	Parameter	Conditions	LM2576 -15 LM2576HV -15		Units (Limits)
			Typ	Limit (Note 2)	
<b>SYSTEM PARAMETERS (Note 3) Test Circuit Figure 2</b>					
$V_{OUT}$	Output Voltage	$V_{IN} = 25$ , $I_{LOAD} = 0.5\text{A}$ Circuit of Figure 2	15	14.70 15.30	V V(Min) V(Max)
$V_{OUT}$	Output Voltage MIK2576	$0.5\text{A} \leq I_{LOAD} \leq 3\text{A}$ , $18 \leq V_{IN} \leq 40\text{V}$ Circuit of Figure 2	15	14.40/ <b>14.25</b> 15.60/ <b>15.75</b>	V V(Min) V(Max)
$V_{OUT}$	Output Voltage MIK2576HV	$0.5\text{A} \leq I_{LOAD} \leq 3\text{A}$ , $18 \leq V_{IN} \leq 60\text{V}$ Circuit of Figure 2	15	14.40/ <b>14.25</b> 15.68/ <b>15.83</b>	V V(Min) V(Max)
$\eta$	Efficiency	$V_{IN} = 18\text{V}$ , $I_{LOAD} = 3\text{A}$	88		%

## Electrical Characteristics LM2576 -ADJ, LM2576HV -ADJ

Specifications with standard type face are for  $T_J = 25^\circ\text{C}$ , and those with **boldface type** apply over full Operating Temperature Range.

Symbol	Parameter	Conditions	LM2576 -ADJ LM2576HV -ADJ		Units (Limits)
			Typ	Limit(Note 2)	
<b>SYSTEM PARAMETERS (Note 3) Test Circuit Figure 2</b>					
$V_{OUT}$	Feedback Voltage	$V_{IN} = 12\text{V}$ , $I_{LOAD} = 0.5\text{A}$ , $V_{OUT} = 5\text{V}$ Circuit of Figure 2	1.230	1.217 1.243	V V(Min) V(Max)
$V_{OUT}$	Feedback Voltage MIK2576	$0.5\text{A} \leq I_{LOAD} \leq 3\text{A}$ , $8\text{V} \leq V_{IN} \leq 40\text{V}$ $V_{OUT} = 5\text{V}$ Circuit of Figure 2	1.230	1.193/ <b>1.180</b> 1.267/ <b>1.280</b>	V V(Min) V(Max)
$V_{OUT}$	Feedback Voltage MIK2576HV	$0.5\text{A} \leq I_{LOAD} \leq 3\text{A}$ , $8\text{V} \leq V_{IN} \leq 60\text{V}$ , $V_{OUT} = 5\text{V}$ Circuit of Figure 2	1.230	1.193/ <b>1.180</b> 1.273/ <b>1.286</b>	V V(Min) V(Max)
$\eta$	Efficiency	$V_{IN} = 12\text{V}$ , $I_{LOAD} = 3\text{A}$ , $V_{OUT} = 5\text{V}$	77		%

## All Output Voltage Versions Electrical Characteristics

Specifications with standard type face are for  $T_J = 25^\circ\text{C}$ , and those with **boldface type** apply over full Operating Temperature Range. Unless otherwise specified,  $V_{IN} = 12\text{V}$  for the 3.3V, 5V, and Adjustable version,  $V_{IN} = 25\text{V}$  for the 12V version, and  $V_{IN} = 30\text{V}$  for the 15V version,  $I_{LOAD} = 500\text{mA}$ .

Symbol	Parameter	Conditions	LM2576-XX LM2576HV-XX		Units (Limits)
			Typ	Limit (Note 2)	
<b>DEVICE PARAMETERS</b>					
$I_b$	Feedback Bias Current	$V_{OUT} = 5\text{V}$ (Adjustable Version Only)	50	100/ <b>500</b>	nA
$f_o$	Oscillator Frequency	(Note 8)	52	47/ <b>42</b> 58/ <b>63</b>	kHz kHz(Min) kHz(Max)
$V_{SAT}$	Saturation Voltage	$I_{OUT} = 3\text{A}$ (Note 4)	1.4	1.8/ <b>2.0</b>	V V(Max)
DC	Max Duty Cycle (ON)	(Note 5)	98	93	% %(Min)
$I_{CL}$	Current Limit	(Notes 4, 8)	5.8	4.2/ <b>3.5</b> 6.9/ <b>7.5</b>	A A(Min) A(Max)
$I_L$	Output Leakage Current	(Notes 6, 7):  Output = -1V Output = -1V	7.5	2 30	mA(Max) mA mA(Max)
$I_Q$	Quiescent Current	(Note 6)	5	10	mA mA(Max)
$I_{STBY}$	Standby Quiescent Current	$\overline{\text{ON/OFF Pin}} = 5\text{V}$ (OFF)	50	200	$\mu\text{A}$ $\mu\text{A}(\text{Max})$
<b>ON/OFF CONTROL</b>					
$V_{IH}$	$\overline{\text{ON/OFF Pin}}$ Logic Input Level	$V_{OUT} = 0\text{V}$	1.4	2.2/ <b>2.4</b>	V(Min)
$V_{IL}$		$V_{OUT} = \text{Nominal Output Voltage}$	1.2	1.0/ <b>0.8</b>	V(Max)
$I_{IH}$	$\overline{\text{ON/OFF Pin}}$ Input Current	$\overline{\text{ON/OFF Pin}} = 5\text{V}$ (OFF)	12	30	$\mu\text{A}$ $\mu\text{A}(\text{Max})$
$I_{IL}$		$\overline{\text{ON/OFF Pin}} = 0\text{V}$ (ON)	0	10	$\mu\text{A}$ $\mu\text{A}(\text{Max})$

**Note 1:** Absolute Maximum Ratings indicate limits beyond which damage to the device may occur. Operating Ratings indicate conditions for which the device is intended to be functional, but do not guarantee specific performance limits. For guaranteed specifications and test conditions, see the Electrical Characteristics.

**Note 2:** All limits guaranteed at room temperature (standard type face) and at temperature extremes (**bold type face**).

**Note 3:** External components such as the catch diode, inductor, input and output capacitors can affect switching regulator system performance. When the LM2576/LM2576HV is used as shown in the *Figure 2* test circuit, system performance will be as shown in system parameters section of Electrical Characteristics.

**Note 4:** Output pin sourcing current. No diode, inductor or capacitor connected to output.

**Note 5:** Feedback pin removed from output and connected to 0V.

**Note 6:** Feedback pin removed from output and connected to +12V for the Adjustable, 3.3V, and 5V, versions, and +25V for the 12V and 15V versions, to force the output transistor OFF.

**Note 7:**  $V_{IN} = 40\text{V}$  (60V for high voltage version).

**Note 8:** The oscillator frequency reduces to approximately 11 kHz in the event of an output short or an overload which causes the regulated output voltage to drop approximately 40% from the nominal output voltage. This self protections feature lowers the average power dissipation of the IC by lowering the minimum duty cycle from 5% down to approximately 2%.

## Typical Performance Characteristics (Circuit of Figure 2)

### Normalized Output Voltage

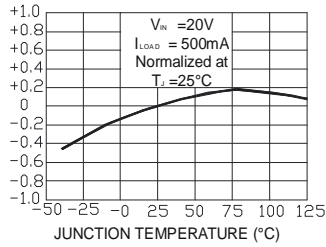

### Line Regulation

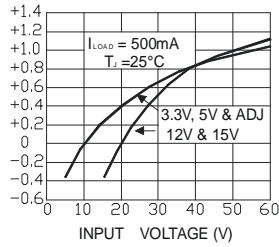

### Dropout Voltage

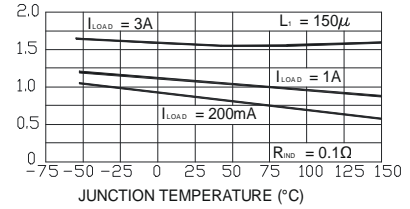

### Standby Quiescent Current

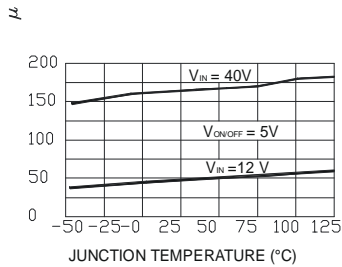

### Quiescent Current

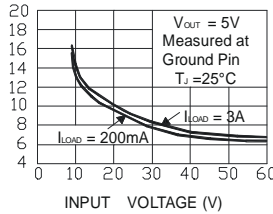

### Current Limit

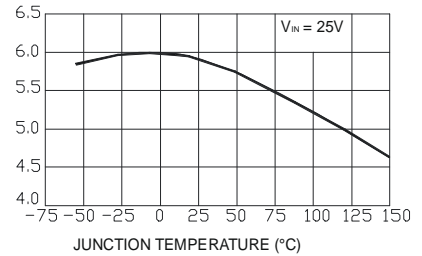

### Switch Saturation Voltage

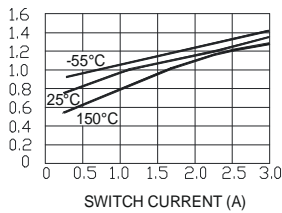

### Efficiency

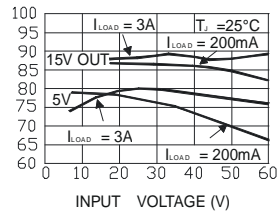

### Oscillator Frequency

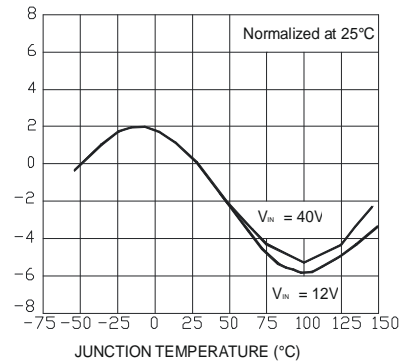

### Minimum Operating Voltage

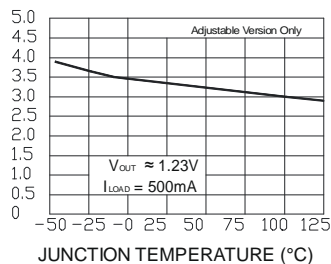

### Quiescent Current vs Duty Cycle

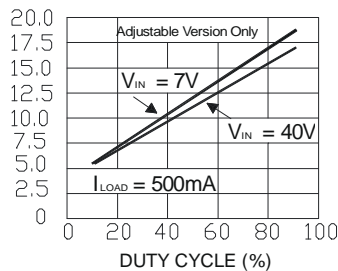

### Feedback Voltage vs Duty Cycle

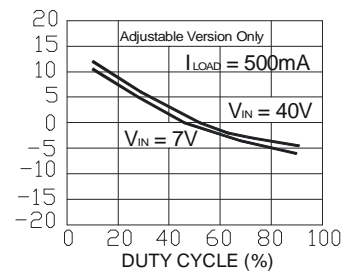

### Maximum Power Dissipation (TO-263)

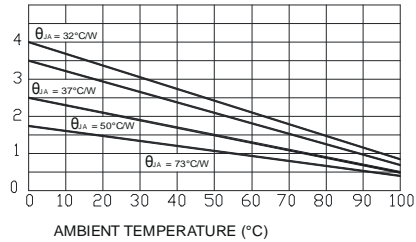

### Feedback Pin Current

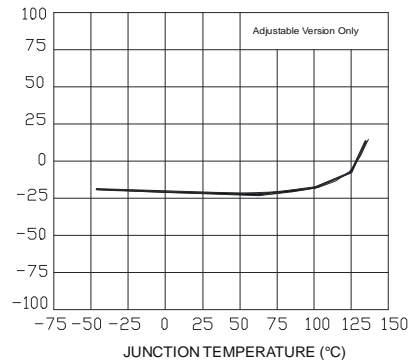

### Switching Waveforms

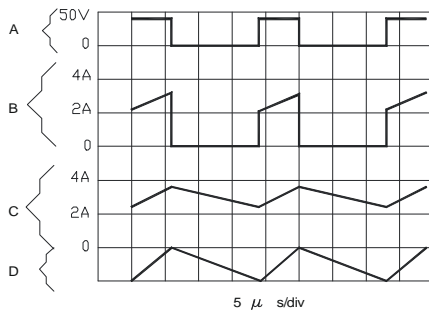

### Load Transient

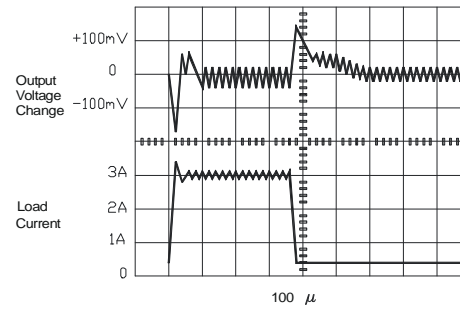

$V_{OUT} = 15V$

A: Output Pin Voltage, 50V/div

B: Output Pin Current, 2A/div

C: Inductor Current, 2A/div

D: Output Ripple Voltage, 50mV/div,

AC-Coupled

Horizontal Time Base: 5μs/div

### Test Circuit and Layout Guidelines

As in any switching regulator, layout is very important. Rapidly switching currents associated with wiring inductance generate voltage transients which can cause problems. For minimal inductance and ground loops, the length of the leads indicated by heavy lines should be kept as short as possible.

Single-point grounding (as indicated) or ground plane construction should be used for best results. When using the Adjustable version, physically locate the programming resistors near the regulator, to keep the sensitive feedback wiring short.

#### Fixed Output Voltage Versions (Figure 2a)

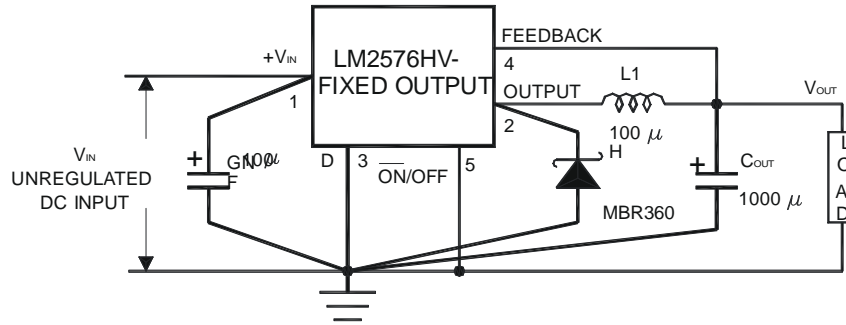

- C<sub>IN</sub> — 100µF, 75V, Aluminum Electrolytic
- C<sub>OUT</sub> — 1000µF, 25V, Aluminum Electrolytic
- D1 — Schottky, MBR360
- L<sub>1</sub> — 100µH, Pulse Eng. PE-92108
- R<sub>1</sub> — 2k, 0.1%
- R<sub>2</sub> — 6.12k, 0.1%

#### Adjustable Output Voltage Version (Figure 2b)

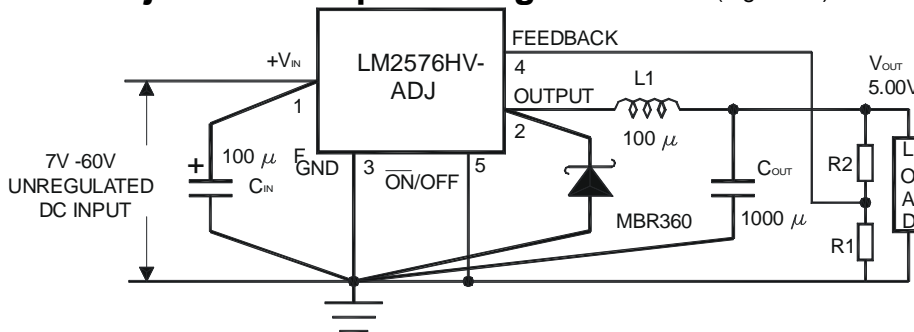

$$V_{OUT} = V_{REF} \left( 1 + \frac{R_2}{R_1} \right)$$

$$R_2 = R_1 \left( \frac{V_{OUT}}{V_{REF}} - 1 \right)$$

where  $V_{REF} = 1.23V$ ,  $R_1$  between 1k and 5k



## Package Information (1) TO220-5L

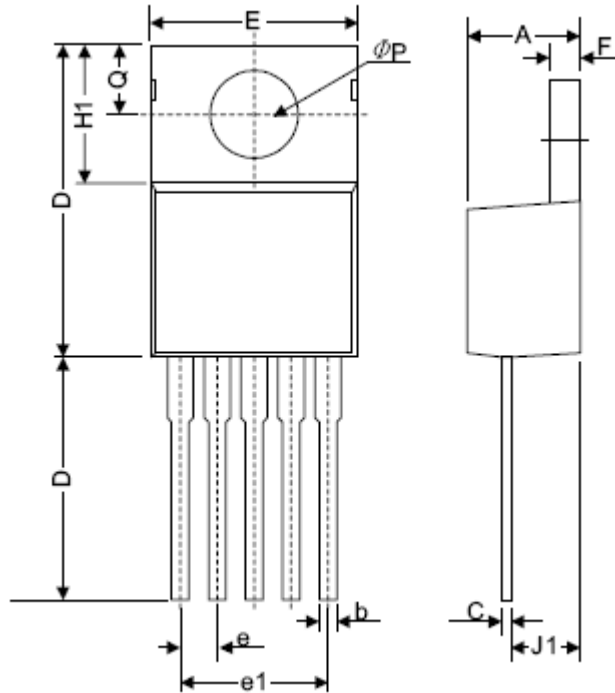

Symbol	Dimensions In Millimeters		Dimensions In Inches	
	Min.	Max.	Min.	Max.
A	4.06	4.83	0.160	0.190
b	0.76	1.02	0.030	0.040
C	0.36	0.64	0.014	0.025
D	14.22	15.49	0.560	0.610
E	9.78	10.54	0.385	0.415
e	1.57	1.85	0.062	0.073
e(1)	6.68	6.93	0.263	0.273
F	1.14	1.40	0.045	0.055
H(1)	5.46	6.86	0.215	0.270
J(1)	2.29	3.18	0.090	0.125
L	13.21	14.73	0.520	0.580
φP	3.68	3.94	0.145	0.155
Q	2.54	2.92	0.100	0.115

### Package Information (2) TO263-5L

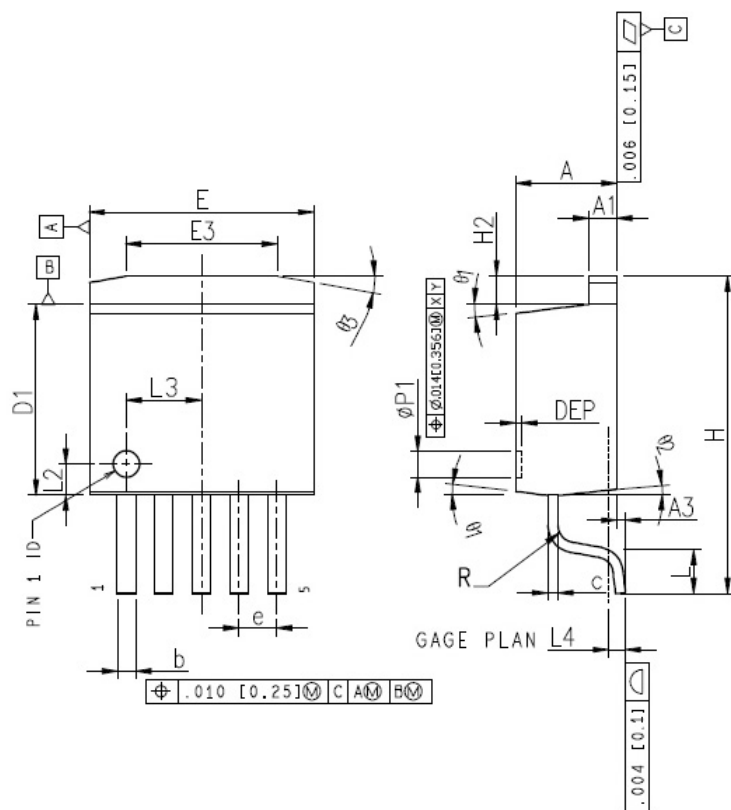

COMMON DIMENSIONS						
SYMBOL	MM			INCH		
	MIN	NDM	MAX	MIN	NDM	MAX
A	4.45	4.57	4.70	0.175	0.180	0.185
A1	1.22	1.27	1.32	0.048	0.050	0.052
A3	0	-	0.15	0.000	-	0.006
b	0.71	-	0.97	0.028	-	0.038
c	0.38	-	0.76	0.015	-	0.030
D1	8.38	8.70	8.89	0.330	0.343	0.350
E	9.91	10.16	10.39	0.390	0.400	0.410
E1	10.03	10.16	10.54	0.395	0.400	0.415
E3	6.61	6.86	7.11	0.260	0.270	0.280
e	1.70BSC			0.067BSC		
H	-	-	14.35	-	-	0.565
H2	-	-	1.27	-	-	0.050
L	-	1.98	-	-	0.078	-
L2	1.47REF			0.058REF		
L3	3.40REF			0.134REF		
L4	-	0.76	-	-	0.030	-
φp1	1.07	1.20	1.32	0.042	0.047	0.052
R	-	-	0.76	-	-	0.030
θ1	-	7°	-	-	7°	-
θ2	-	3°	-	-	3°	-
θ3	7°	10°	13°	7°	10°	13°
θ4	-	3°	-	-	3°	-
DEP	0.10	0.18	0.25	0.004	0.007	0.010

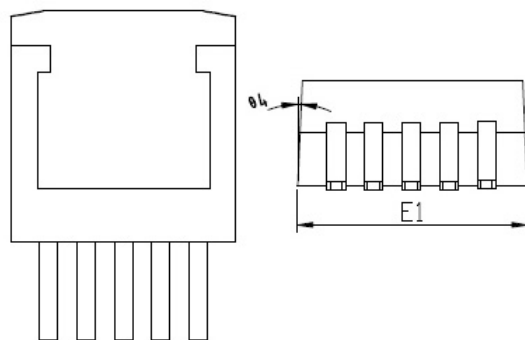

NOTES:  
1. ALL DIMENSIONS REFER TO JEDEC STANDARD TO-263, DO NOT INCLUDE MOLD FLASH OR PROTRUSIONS.