

■ Features

- $V_{DS(V)} = 20V$
- $I_D = 6 A (V_{GS} = 4.5V)$
- $R_{DS(ON)} < 25m\Omega (V_{GS} = 4.5V)$
- $R_{DS(ON)} < 33m\Omega (V_{GS} = 2.5V)$
- $R_{DS(ON)} < 51m\Omega (V_{GS} = 1.8V)$

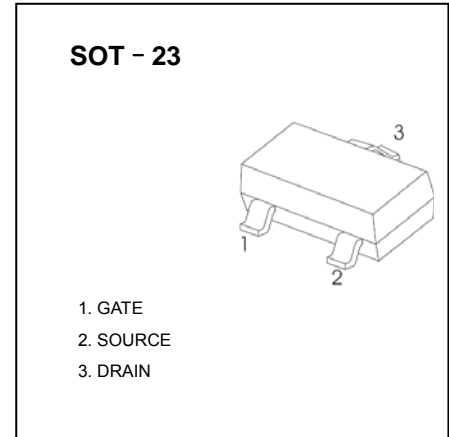
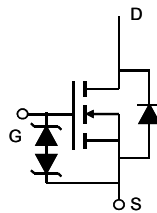

■ Absolute Maximum Ratings  $T_a = 25^\circ C$

Parameter	Symbol	Rating	Unit
Drain-Source Voltage	$V_{DS}$	20	V
Gate-Source Voltage	$V_{GS}$	$\pm 8$	
Continuous Drain Current	$I_D$	$T_a=25^\circ C$	6
		$T_a=70^\circ C$	5
Pulsed Drain Current	$I_{DM}$	30	A
Power Dissipation	$P_D$	$T_a=25^\circ C$	1.4
		$T_a=70^\circ C$	0.9
Thermal Resistance..Junction- to-Ambient $t \leq 10sec$ Steady State	$R_{thJA}$		90
			125
Thermal Resistance..Junction-to-Foot	$R_{thJF}$	80	$^\circ C/W$
Junction Temperature	$T_J$	150	
Storage Temperature Range	$T_{stg}$	-55 to 150	$^\circ C$

■ Electrical Characteristics Ta = 25°C

Parameter	Symbol	Test Conditions	Min	Typ	Max	Unit
Drain-Source Breakdown Voltage	V <sub>DSS</sub>	I <sub>D</sub> =250μA, V <sub>GS</sub> =0V	20			V
Zero Gate Voltage Drain Current	I <sub>DSS</sub>	V <sub>DS</sub> =20V, V <sub>GS</sub> =0V			1	μA
		V <sub>DS</sub> =20V, V <sub>GS</sub> =0V, Ta=70°C			5	
Gate-Body Leakage Current	I <sub>GSS</sub>	V <sub>DS</sub> =0V, V <sub>GS</sub> =±8V			±10	μA
Gate Threshold Voltage	V <sub>GS(th)</sub>	V <sub>DS</sub> =V <sub>GS</sub> , I <sub>D</sub> =250 μ A	0.4		1.1	V
On-State Drain Current	I <sub>D(on)</sub>	V <sub>DS</sub> =5 V, V <sub>GS</sub> = 4.5 V	30			A
Static Drain-Source On-Resistance	R <sub>DS(on)</sub>	V <sub>GS</sub> =4.5V, I <sub>D</sub> =6.5A			25	mΩ
		V <sub>GS</sub> =2.5V, I <sub>D</sub> =5.5A			33	
		V <sub>GS</sub> =1.8V, I <sub>D</sub> =5A			51	
Forward Transconductance	g <sub>FS</sub>	V <sub>DS</sub> =5V, I <sub>D</sub> =6.5A		50		S
Input Capacitance	C <sub>iss</sub>	V <sub>GS</sub> =0V, V <sub>DS</sub> =10V, f=1MHz		1295	1650	pF
Output Capacitance	C <sub>oss</sub>			160		
Reverse Transfer Capacitance	C <sub>rss</sub>			87		
Gate Resistance	R <sub>g</sub>	V <sub>GS</sub> =0V, V <sub>DS</sub> =0V, f=1MHz		1.8		KΩ
Total Gate Charge	Q <sub>g</sub>	V <sub>GS</sub> =4.5V, V <sub>DS</sub> =10V, I <sub>D</sub> =6.5A		10		nC
Gate Source Charge	Q <sub>gs</sub>			4.2		
Gate Drain Charge	Q <sub>gd</sub>			2.6		
Turn-On DelayTime	t <sub>d(on)</sub>	V <sub>DS</sub> =10V, V <sub>GEN</sub> =4.5V R <sub>L</sub> =1.54Ω, R <sub>G</sub> =3Ω		280		ns
Turn-On Rise Time	t <sub>r</sub>			328		
Turn-Off DelayTime	t <sub>d(off)</sub>			3.76		
Turn-Off Fall Time	t <sub>f</sub>			2.24		
Body Diode Reverse Recovery Time	t <sub>rr</sub>			31	41	
Body Diode Reverse Recovery Charg	Q <sub>rr</sub>	I <sub>F</sub> = 6.5A, di/dt= 100A/ μ s		6.8		nC
Maximum Body-Diode Continuous Current	I <sub>S</sub>				2	A
Diode Forward Voltage	V <sub>SD</sub>	I <sub>S</sub> =1.0A, V <sub>GS</sub> =0V		0.62	1	V

\*1 Pulse test: PW ≤ 300us duty cycle ≤ 2%.

■ Typical Characteristics

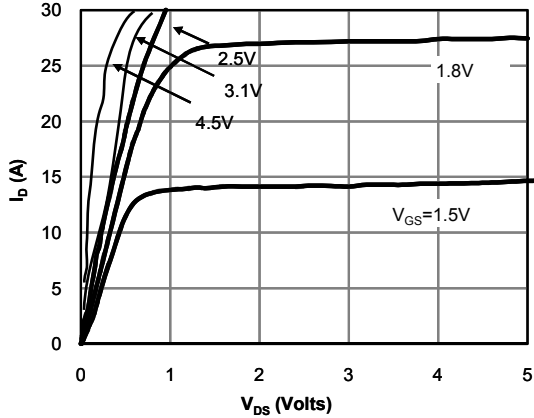

Fig 1: On-Region Characteristics (Note E)

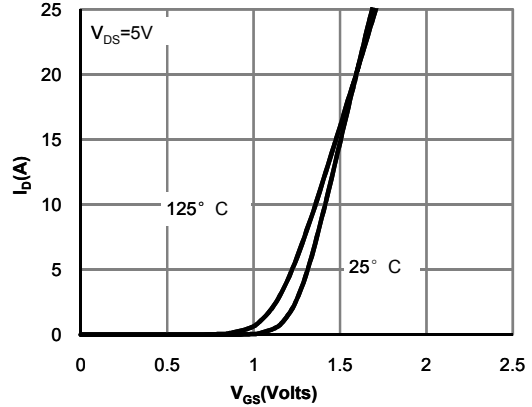

Figure 2: Transfer Characteristics (Note E)

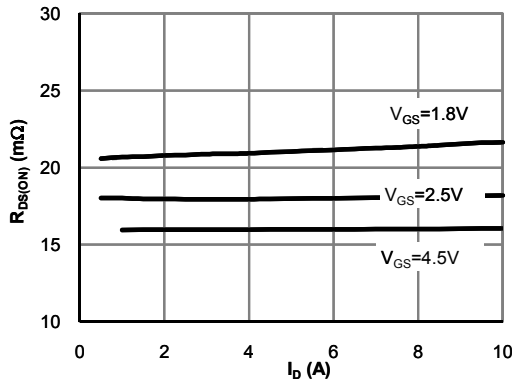

Figure 3: On-Resistance vs. Drain Current and Gate Voltage (Note E)

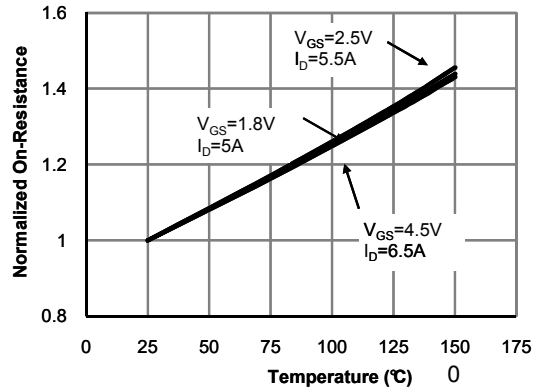

Figure 4: On-Resistance vs. Junction Temperature (Note E)

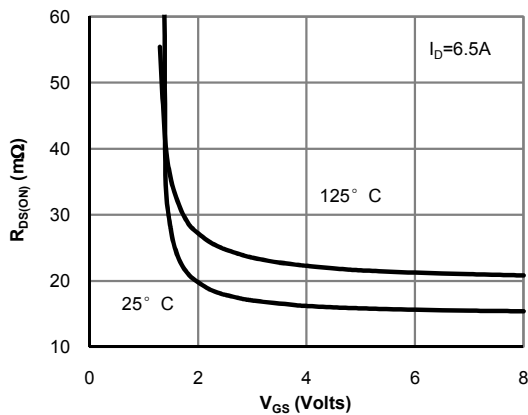

Figure 5: On-Resistance vs. Gate-Source Voltage (Note E)

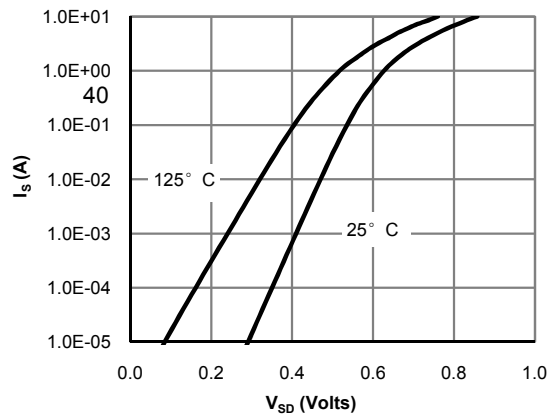

Figure 6: Body-Diode Characteristics (Note E)

■ Typical Characteristics

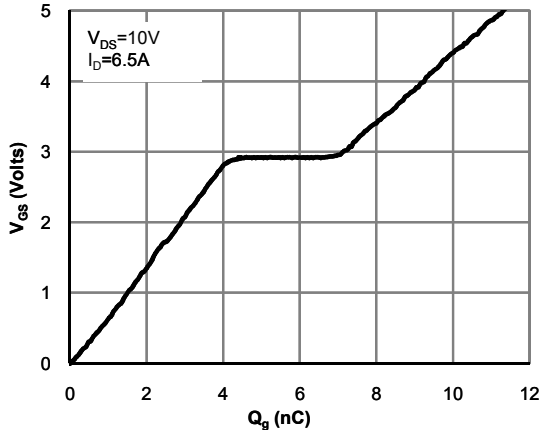

Figure 7: Gate-Charge Characteristics

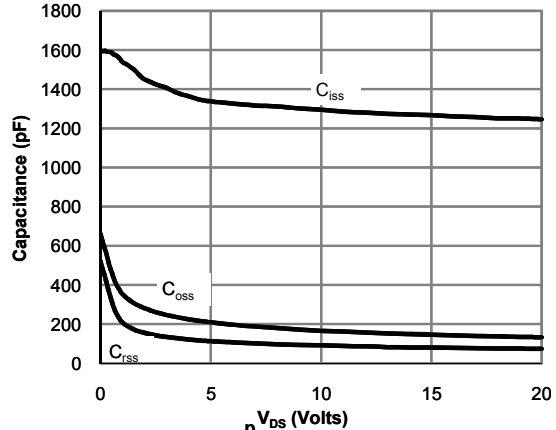

Figure 8: Capacitance Characteristics

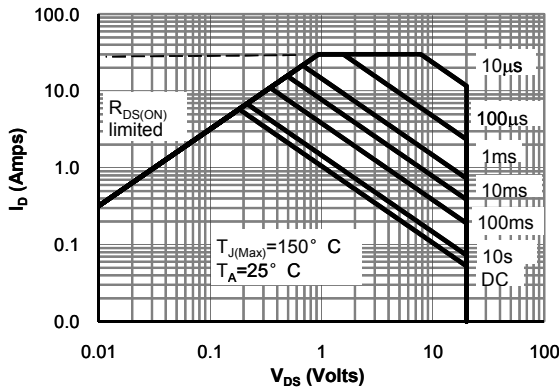

Figure 9: Maximum Forward Biased Safe Operating Area (Note F)

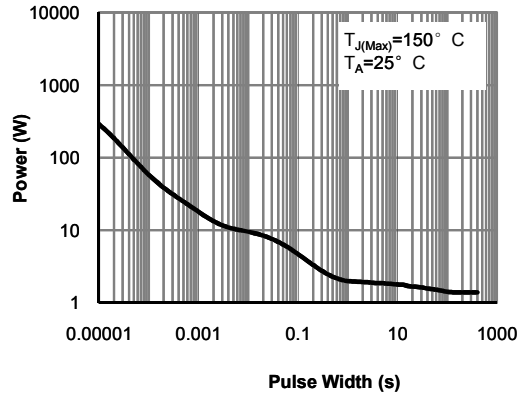

Figure 10: Single Pulse Power Rating Junction-to-Ambient (Note F)

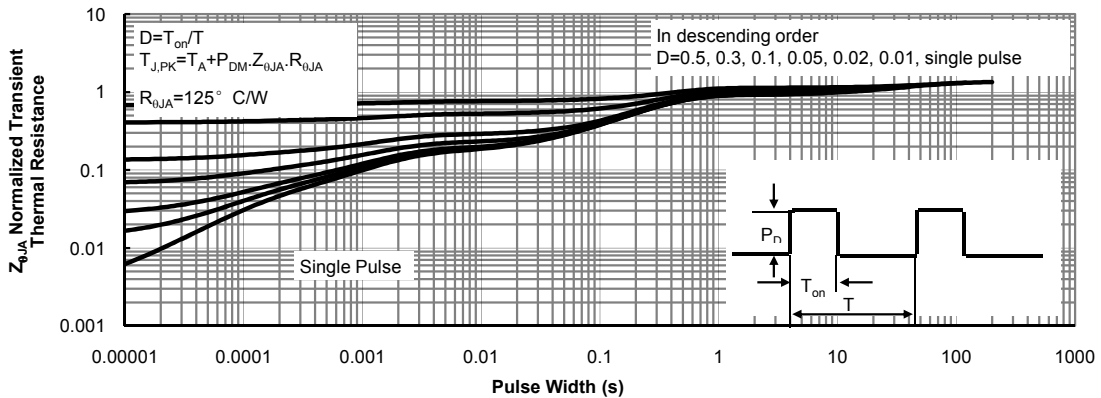
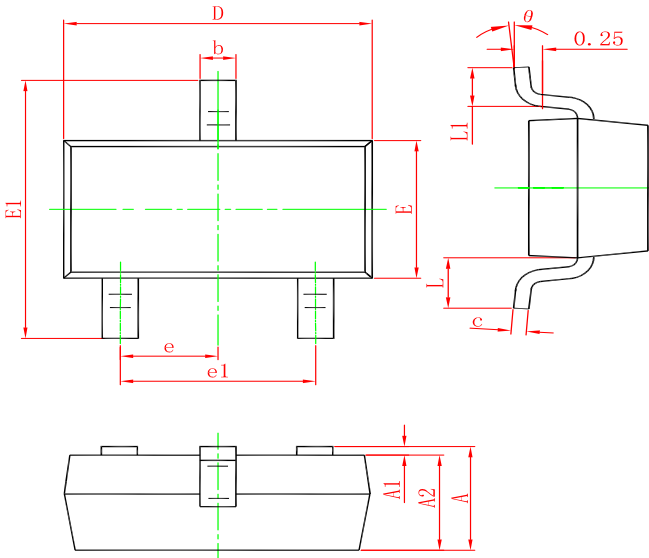

Figure 11: Normalized Maximum Transient Thermal Impedance (Note F)

SOT-23 PACKAGE OUTLINE DIMENSIONS



Symbol	Dimensions In Millimeters		Dimensions In Inches	
	Min.	Max.	Min.	Max.
A	0.900	1.150	0.035	0.045
A1	0.000	0.100	0.000	0.004
A2	0.900	1.050	0.035	0.041
b	0.300	0.500	0.012	0.020
c	0.080	0.150	0.003	0.006
D	2.800	3.000	0.110	0.118
E	1.200	1.400	0.047	0.055
E1	2.250	2.550	0.089	0.100
e	0.950 TYP.		0.037 TYP.	
e1	1.800	2.000	0.071	0.079
L	0.550 REF.		0.022 REF.	
L1	0.300	0.500	0.012	0.020
θ	0°	8°	0°	8°

Marking

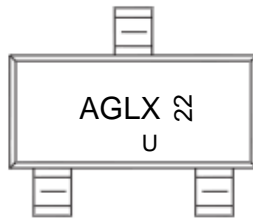

Ordering information

Order code	Package	Baseqty	Deliverymode
AO3416A	SOT-23	3000	Tape and reel