

**General Description**

The AO3480 combines advanced trench MOSFET technology with a low resistance package to provide extremely low  $R_{DS(ON)}$ . This device is suitable for use as a load switch or in PWM applications.

**Product Summary**

$V_{DS}$	30V
$I_D$ (at $V_{GS}=10V$ )	5.7A
$R_{DS(ON)}$ (at $V_{GS}=10V$ )	< 26.5mΩ
$R_{DS(ON)}$ (at $V_{GS} = 4.5V$ )	< 32mΩ
$R_{DS(ON)}$ (at $V_{GS} = 2.5V$ )	< 50mΩ

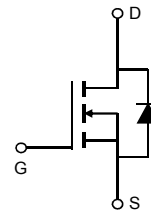
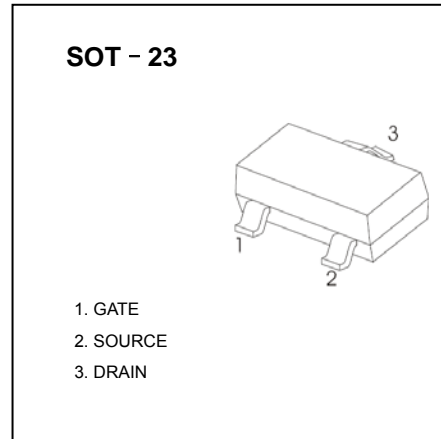

**Absolute Maximum Ratings  $T_A=25^{\circ}C$  unless otherwise noted**

Parameter	Symbol	Maximum	Units
Drain-Source Voltage	$V_{DS}$	30	V
Gate-Source Voltage	$V_{GS}$	±12	V
Continuous Drain Current	$I_D$	$T_A=25^{\circ}C$	5.7
		$T_A=70^{\circ}C$	4.7
Pulsed Drain Current <sup>C</sup>	$I_{DM}$	30	A
Power Dissipation <sup>B</sup>	$P_D$	$T_A=25^{\circ}C$	1.4
		$T_A=70^{\circ}C$	0.9
Junction and Storage Temperature Range	$T_J, T_{STG}$	-55 to 150	°C

**Thermal Characteristics**

Parameter	Symbol	Typ	Max	Units
Maximum Junction-to-Ambient <sup>A</sup>	$R_{\theta JA}$	70	90	°C/W
Maximum Junction-to-Ambient <sup>A,D</sup>		Steady-State	100	125
Maximum Junction-to-Lead	$R_{\theta JL}$	63	80	°C/W

Electrical Characteristics (T<sub>J</sub>=25°C unless otherwise noted)

Symbol	Parameter	Conditions	Min	Typ	Max	Units
<b>STATIC PARAMETERS</b>						
BV <sub>DSS</sub>	Drain-Source Breakdown Voltage	I <sub>D</sub> =250μA, V <sub>GS</sub> =0V	30			V
I <sub>DSS</sub>	Zero Gate Voltage Drain Current	V <sub>DS</sub> =30V, V <sub>GS</sub> =0V T <sub>J</sub> =55°C			1 5	μA
I <sub>GSS</sub>	Gate-Body leakage current	V <sub>DS</sub> =0V, V <sub>GS</sub> = ±12V			100	nA
V <sub>GS(th)</sub>	Gate Threshold Voltage	V <sub>DS</sub> =V <sub>GS</sub> , I <sub>D</sub> =250μA	0.65	1.05	1.45	V
I <sub>D(ON)</sub>	On state drain current	V <sub>GS</sub> =4.5V, V <sub>DS</sub> =5V	30			A
R <sub>DS(ON)</sub>	Static Drain-Source On-Resistance	V <sub>GS</sub> =10V, I <sub>D</sub> =5.7A		18	26.5	mΩ
		V <sub>GS</sub> =4.5V, I <sub>D</sub> =5A		19	32	mΩ
		V <sub>GS</sub> =2.5V, I <sub>D</sub> =3A		24	50	mΩ
g <sub>FS</sub>	Forward Transconductance	V <sub>DS</sub> =5V, I <sub>D</sub> =5.7A		33		S
V <sub>SD</sub>	Diode Forward Voltage	I <sub>S</sub> =1A, V <sub>GS</sub> =0V		0.7	1	V
I <sub>S</sub>	Maximum Body-Diode Continuous Current				2	A
<b>DYNAMIC PARAMETERS</b>						
C <sub>iss</sub>	Input Capacitance	V <sub>GS</sub> =0V, V <sub>DS</sub> =15V, f=1MHz		630		pF
C <sub>oss</sub>	Output Capacitance			75		pF
C <sub>rss</sub>	Reverse Transfer Capacitance			50		pF
R <sub>g</sub>	Gate resistance	V <sub>GS</sub> =0V, V <sub>DS</sub> =0V, f=1MHz	1.5	3	4.5	Ω
<b>SWITCHING PARAMETERS</b>						
Q <sub>g</sub>	Total Gate Charge	V <sub>GS</sub> =4.5V, V <sub>DS</sub> =15V, I <sub>D</sub> =5.7A		6	10	nC
Q <sub>gs</sub>	Gate Source Charge			1.3		nC
Q <sub>gd</sub>	Gate Drain Charge			1.8		nC
t <sub>D(on)</sub>	Turn-On DelayTime	V <sub>GS</sub> =10V, V <sub>DS</sub> =15V, R <sub>L</sub> =2.6Ω, R <sub>GEN</sub> =3Ω		3		ns
t <sub>r</sub>	Turn-On Rise Time			2.5		ns
t <sub>D(off)</sub>	Turn-Off DelayTime			25		ns
t <sub>f</sub>	Turn-Off Fall Time			4		ns
t <sub>rr</sub>	Body Diode Reverse Recovery Time	I <sub>F</sub> =5.7A, di/dt=100A/μs		8.5		ns
Q <sub>rr</sub>	Body Diode Reverse Recovery Charge	I <sub>F</sub> =5.7A, di/dt=100A/μs		2.6		nC

A. The value of R<sub>θJA</sub> is measured with the device mounted on 1in<sup>2</sup> FR-4 board with 2oz. Copper, in a still air environment with T<sub>A</sub>=25° C. The value in any given application depends on the user's specific board design.

B. The power dissipation P<sub>D</sub> is based on T<sub>J(MAX)</sub>=150° C, using ≤ 10s junction-to-ambient thermal resistance.

C. Repetitive rating, pulse width limited by junction temperature T<sub>J(MAX)</sub>=150° C. Ratings are based on low frequency and duty cycles to keep initial T<sub>J</sub>=25° C.

D. The R<sub>θJA</sub> is the sum of the thermal impedance from junction to lead R<sub>θJL</sub> and lead to ambient.

E. The static characteristics in Figures 1 to 6 are obtained using <300μs pulses, duty cycle 0.5% max.

F. These curves are based on the junction-to-ambient thermal impedance which is measured with the device mounted on 1in<sup>2</sup> FR-4 board with 2oz. Copper, assuming a maximum junction temperature of T<sub>J(MAX)</sub>=150° C. The SOA curve provides a single pulse rating.

TYPICAL ELECTRICAL AND THERMAL CHARACTERISTICS

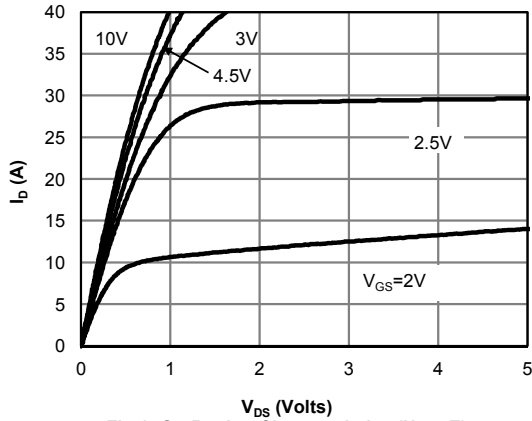

Fig 1: On-Region Characteristics (Note E)

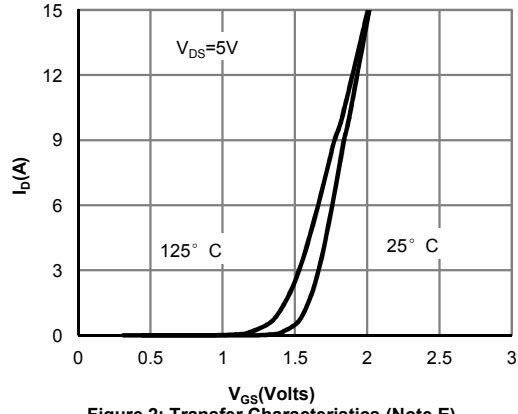

Figure 2: Transfer Characteristics (Note E)

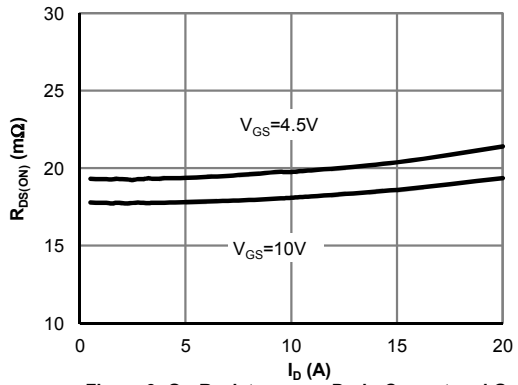

Figure 3: On-Resistance vs. Drain Current and Gate Voltage (Note E)

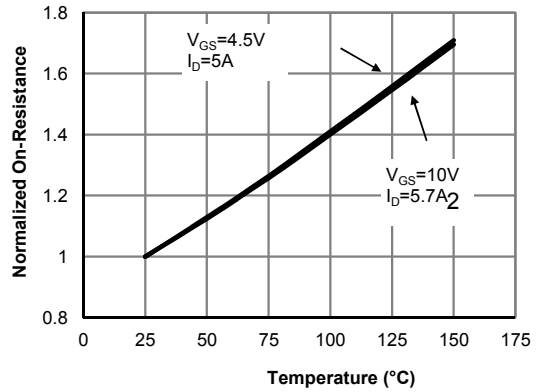

Figure 4: On-Resistance vs. Junction Temperature (Note E)

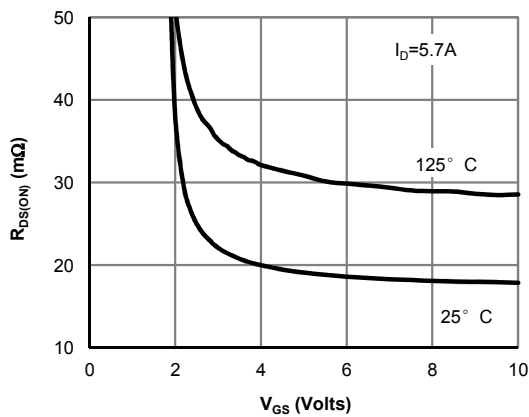

Figure 5: On-Resistance vs. Gate-Source Voltage (Note E)

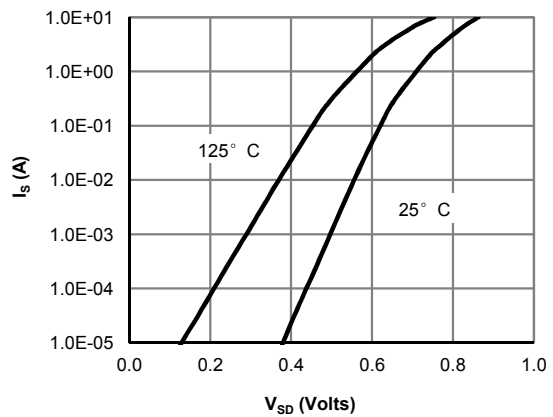

Figure 6: Body-Diode Characteristics (Note E)

TYPICAL ELECTRICAL AND THERMAL CHARACTERISTICS

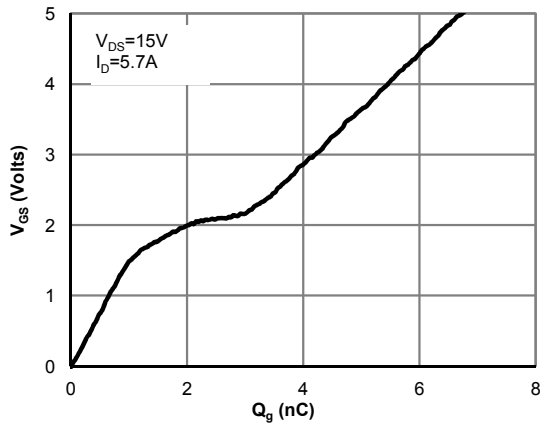

Figure 7: Gate-Charge Characteristics

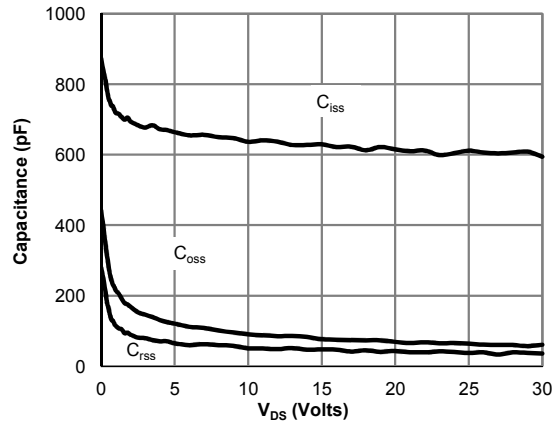

Figure 8: Capacitance Characteristics

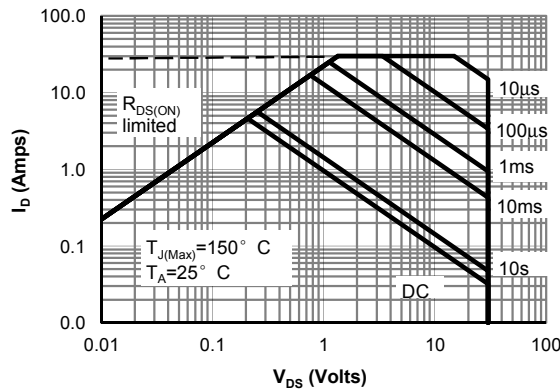

Figure 9: Maximum Forward Biased Safe Operating Area (Note F)

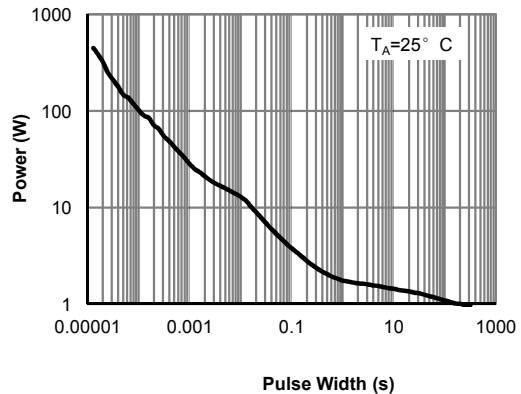

Figure 10: Single Pulse Power Rating Junction-to-Ambient (Note F)

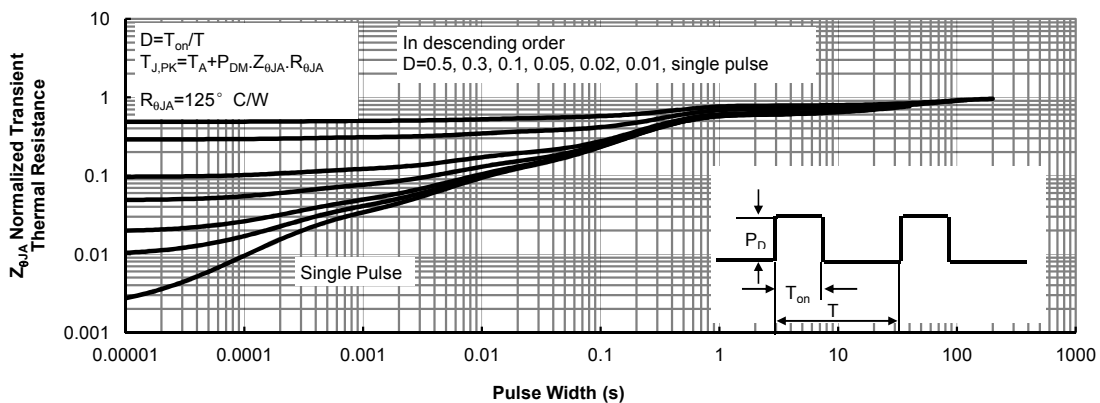
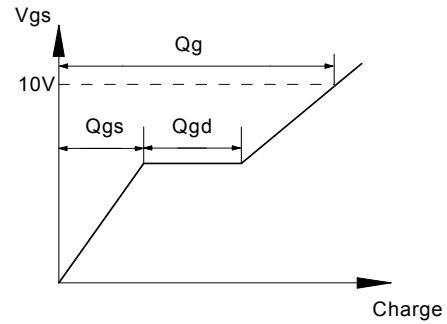
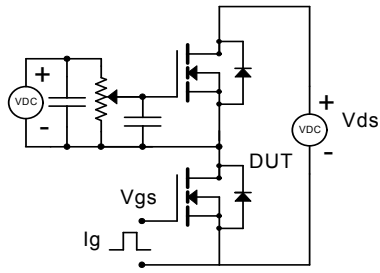
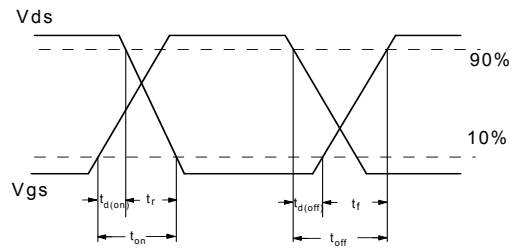
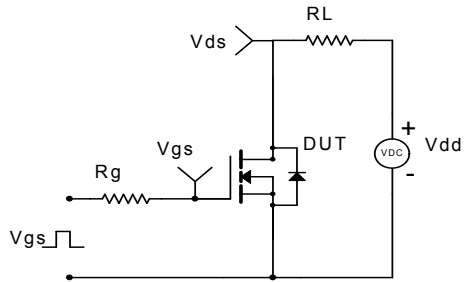

Figure 11: Normalized Maximum Transient Thermal Impedance (Note F)

Gate Charge Test Circuit & Waveform



Resistive Switching Test Circuit & Waveforms



Diode Recovery Test Circuit & Waveforms

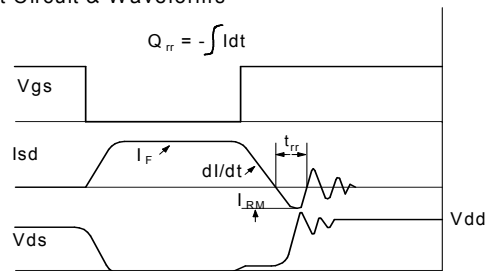
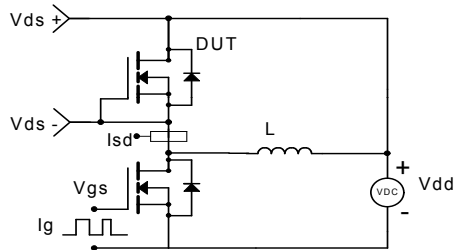

## SOT-23 PACKAGE OUTLINE DIMENSIONS

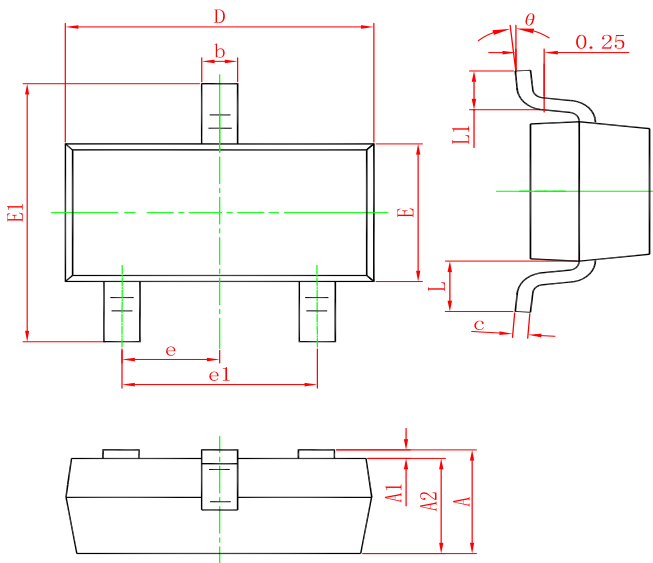

Symbol	Dimensions In Millimeters		Dimensions In Inches	
	Min.	Max.	Min.	Max.
A	0.900	1.150	0.035	0.045
A1	0.000	0.100	0.000	0.004
A2	0.900	1.050	0.035	0.041
b	0.300	0.500	0.012	0.020
c	0.080	0.150	0.003	0.006
D	2.800	3.000	0.110	0.118
E	1.200	1.400	0.047	0.055
E1	2.250	2.550	0.089	0.100
e	0.950 TYP.		0.037 TYP.	
e1	1.800	2.000	0.071	0.079
L	0.550 REF.		0.022 REF.	
L1	0.300	0.500	0.012	0.020
$\theta$	0°	8°	0°	8°

## Marking

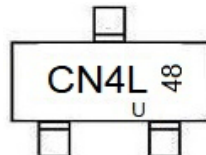

## Ordering information

Order code	Package	Baseqty	Deliverymode
AO3480A	SOT-23	3000	Tape and reel