

Features

- Transient Voltage Suppression (TVS) protection of one line
- Max. peak pulse power: $P_{PP} = 890 \text{ W}$
- Low clamping voltage: $V_{CL} = 19 \text{ V}$
- Low leakage current: $I_{RM} = 300 \text{ nA}$
- ESD protection up to 30 kV
- IEC 61000-4-2; level 4 (ESD)
- IEC 61000-4-5 (surge); $I_{PP} = 47 \text{ A}$
- AEC-Q101 qualified

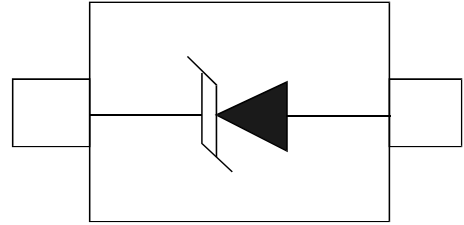

Applications

- Computers and peripherals
- Audio and video equipment
- Cellular handsets and accessories
- Communication systems
- Portable electronics
- Medical and industrial equipment

Mechanical Data

- SOD-323 package
- Molding compound flammability rating: UL94V-0
- Packaging: Tape and Reel
- RoHS/WEEE Compliant

Quick reference data

Table 2. Quick reference data
 $T_{amb} = 25 \text{ }^\circ\text{C}$ unless otherwise specified.

| Symbol | Parameter | Conditions | Min | Typ | Max | Unit |
|-----------|--------------------------|--|-----|-----|-----|------|
| V_{RWM} | reverse standoff voltage | | - | - | 12 | V |
| C_d | diode capacitance | $f = 1 \text{ MHz}; V_R = 0 \text{ V}$ | - | 160 | 180 | pF |

Limiting values

Limiting values

In accordance with the Absolute Maximum Rating System (IEC 60134).

| Symbol | Parameter | Conditions | | Min | Max | Unit |
|-----------------|--------------------|--------------------------|--------|-----|------|------|
| P _{PP} | peak pulse power | t _p = 8/20 μs | [1][2] | - | 600 | W |
| I _{PP} | peak pulse current | t _p = 8/20 μs | [1][2] | - | 22.5 | A |

Limiting values ...continued

In accordance with the Absolute Maximum Rating System (IEC 60134).

| Symbol | Parameter | Conditions | | Min | Max | Unit |
|------------------|-------------------------|--------------------------|-----|-----|------|------|
| P _{tot} | total power dissipation | T _{amb} ≤ 25 °C | [3] | - | 360 | mW |
| | | | [4] | - | 500 | mW |
| T _j | junction temperature | | | - | 150 | °C |
| T _{amb} | ambient temperature | | | -55 | +150 | °C |
| T _{stg} | storage temperature | | | -65 | +150 | °C |

[1] Non-repetitive current pulse 8/20 μs exponential decay waveform according to IEC 61000-4-5.

[2] Soldering point of cathode tab.

[3] Device mounted on an FR4 Printed-Circuit Board (PCB), single-sided copper, tin-plated and standard footprint.

[4] Device mounted on an FR4 PCB, single-sided copper, tin-plated, mounting pad for cathode 1 cm².

ESD maximum ratings

T_{amb} = 25 °C unless otherwise specified.

| Symbol | Parameter | Conditions | | Min | Max | Unit |
|------------------|---------------------------------|--------------------------------------|-----|-----|-----|------|
| V _{ESD} | electrostatic discharge voltage | IEC 61000-4-2 (contact discharge) | [1] | - | 30 | kV |
| | | machine model | | - | 400 | V |

[1] Device stressed with ten non-repetitive ESD pulses.

ESD standards compliance

| Standard | Conditions |
|---|---------------------------------|
| IEC 61000-4-2; level 4 (ESD) | > 15 kV (air); > 8 kV (contact) |
| MIL-STD-883; class 3 (human body model) | > 4 kV |

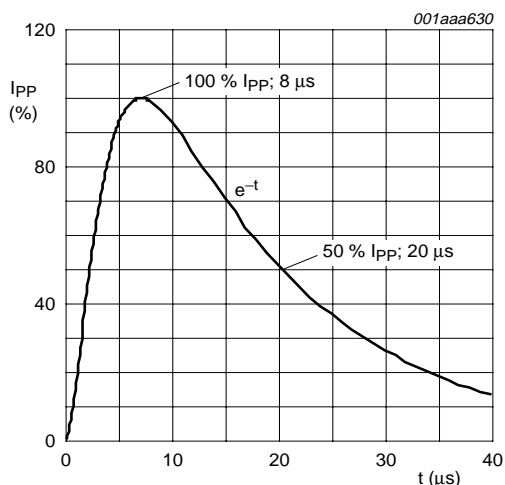

8/20 μs pulse waveform according to IEC 61000-4-5

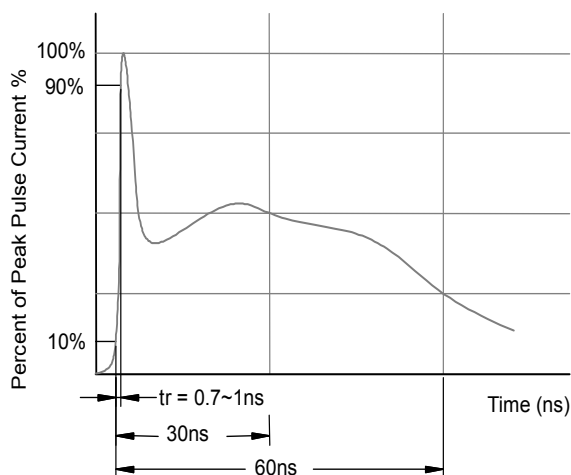

ESD pulse waveform according to IEC 61000-4-2

Characteristics

Characteristics

$T_{amb} = 25\text{ °C}$ unless otherwise specified.

| Symbol | Parameter | Conditions | Min | Typ | Max | Unit |
|-----------|--------------------------|---|------|------|-------|---------------|
| V_{RWM} | reverse standoff voltage | | - | - | 12 | V |
| I_{RM} | reverse leakage current | $V_{RWM} = 12\text{ V}$ | - | <1 | 0.1 | μA |
| V_{BR} | breakdown voltage | $I_R = 5\text{ mA}$ | 13.3 | 14.5 | 17.75 | V |
| C_d | diode capacitance | $f = 1\text{ MHz};$ $V_R = 0\text{ V}$ | - | 160 | 180 | pF |
| V_{CL} | clamping voltage | $I_{PP} = 47\text{ A}$ | [1] | - | 27 | V |
| | | $I_{PP} = 25\text{ A}$ | - | - | 23.5 | V |
| | | $I_{PP} = 5\text{ A}$ | - | - | 19 | V |
| r_{dif} | differential resistance | $I_R = 5\text{ mA}$ | - | 2 | 100 | Ω |

[1] Non-repetitive current pulse 8/20 μs exponential decay waveform according to IEC 61000-4-5.

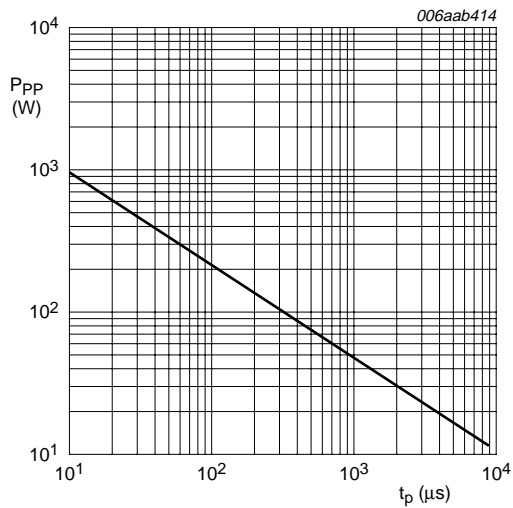

$T_{amb} = 25\text{ °C}$

Peak pulse power as a function of exponential pulse duration; typical values

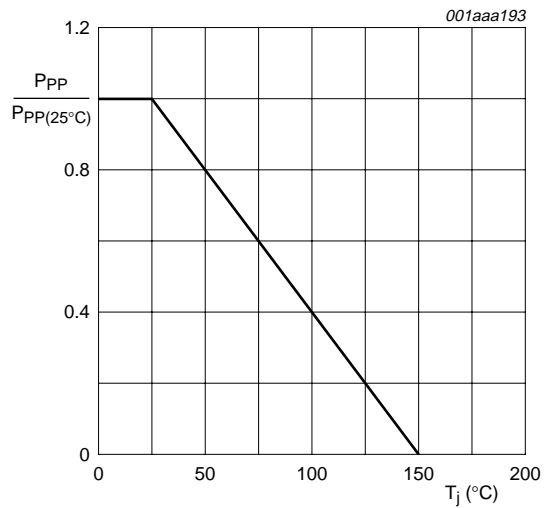

Relative variation of peak pulse power as a function of junction temperature; typical values

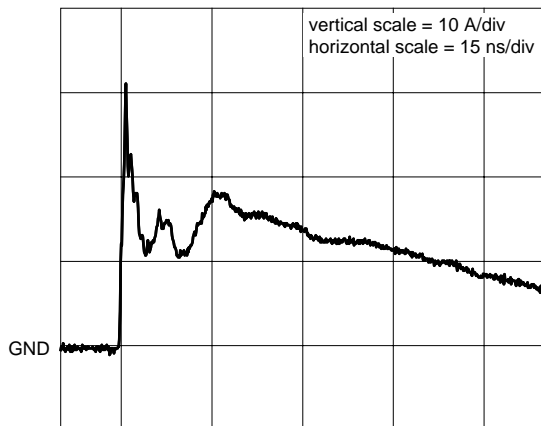

unclamped +8 kV ESD pulse waveform (IEC 61000-4-2 network)

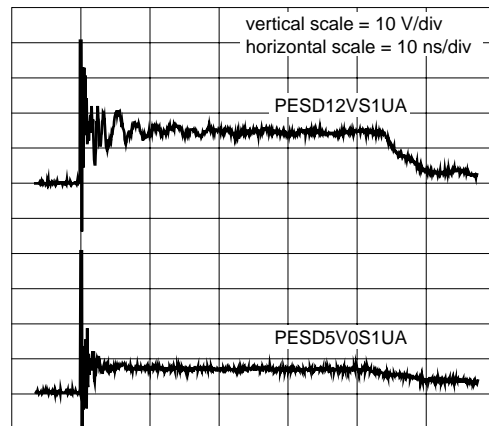

clamped +8 kV ESD pulse waveform (IEC 61000-4-2 network)

Outline Drawing – SOD-323

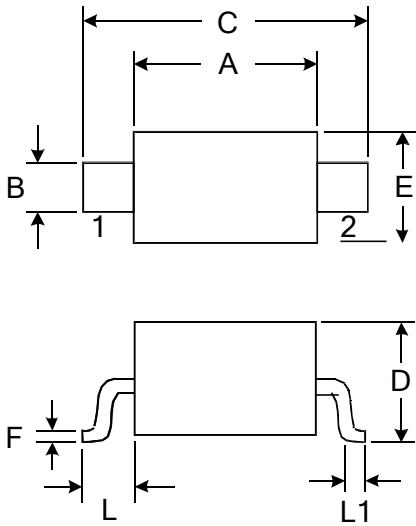

| DIMENSIONS | | | | |
|------------|------------|-------|----------|-------|
| SYMBOL | MILLIMETER | | INCHES | |
| | MIN | MAX | MIN | MAX |
| A | 1.600 | 1.800 | 0.063 | 0.071 |
| B | 0.250 | 0.350 | 0.010 | 0.014 |
| C | 2.500 | 2.700 | 0.098 | 0.106 |
| D | | 1.000 | | 0.039 |
| E | 1.200 | 1.400 | 0.047 | 0.055 |
| F | 0.080 | 0.150 | 0.003 | 0.006 |
| L | 0.475 REF | | 0.019REF | |
| L1 | 0.250 | 0.400 | 0.010 | 0.016 |
| H | 0.000 | 0.100 | 0.000 | 0.004 |

Marking



Ordering information

| Order code | Package | Baseqty | Deliverymode |
|-------------|---------|---------|---------------|
| PESD12VS1UA | SOD-323 | 3000 | Tape and reel |