

Features

- Unidirectional ESD protection of one line
- Max. peak pulse power: $P_{PP} = 160\text{ W}$
- Ultra low leakage current: $I_{RM} < 1\text{ nA}$
- ESD protection up to 23 kV
- IEC 61000-4-2, level 4 (ESD)
- IEC 61000-4-5 (surge); $I_{PP} = 3\text{ A}$

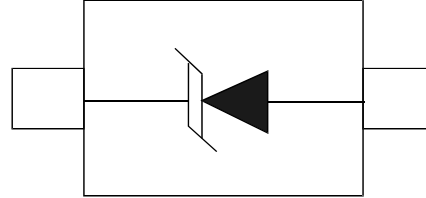

Applications

- Computers and peripherals
- Communication systems
- Audio and video equipment
- Data lines
- Controller Area Network (CAN) bus protection

Mechanical Data

- SOD-323 package
- Molding compound flammability rating: UL94V-0
- Packaging: Tape and Reel
- RoHS/WEEE Compliant

Quick reference data

Quick reference data

Symbol	Parameter	Conditions	Min	Typ	Max	Unit
V_{RWM}	reverse standoff voltage		-	-	24	V
C_d	diode capacitance	$V_R = 0\text{ V}$; $f = 1\text{ MHz}$	-	23	50	pF

Limiting values

In accordance with the Absolute Maximum Rating System (IEC 60134).

Symbol	Parameter	Conditions		Min	Max	Unit
P _{PP}	peak pulse power	t _p = 8/20 μs	[1]	-	160	W
I _{PP}	peak pulse current	t _p = 8/20 μs	[1]	-	3	A
T _j	junction temperature			-	150	°C
T _{amb}	ambient temperature			-65	+150	°C
T _{stg}	storage temperature			-65	+150	°C

[1] Non-repetitive current pulse 8/20 μs exponential decay waveform according to IEC 61000-4-5.

ESD maximum ratings

T_{amb} = 25 °C unless otherwise specified.

Symbol	Parameter	Conditions		Min	Max	Unit
V _{ESD}	electrostatic discharge voltage	IEC 61000-4-2 (contact discharge)	[1]	-	23	kV

[1] Device stressed with ten non-repetitive ESD pulses.

ESD standards compliance

Standard	Conditions
IEC 61000-4-2; level 4 (ESD)	> 15 kV (air); > 8 kV (contact)
MIL-STD-883; class 3 (human body model)	> 4 kV

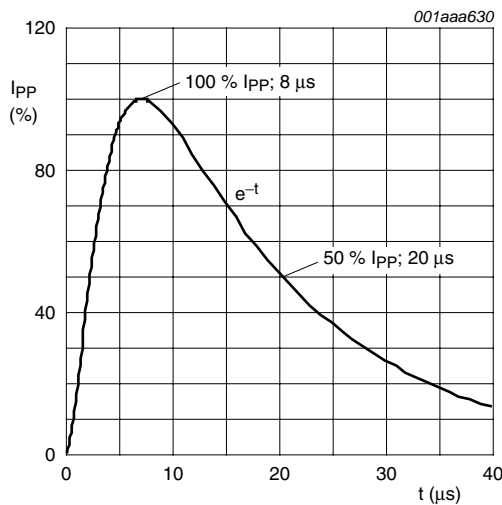

8/20 μs pulse waveform according to IEC 61000-4-5

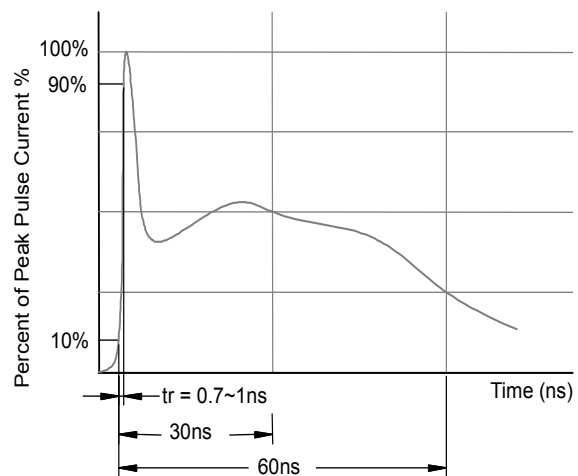

ESD pulse waveform according to IEC 61000-4-2

Characteristics

$T_{amb} = 25\text{ }^{\circ}\text{C}$ unless otherwise specified.

Symbol	Parameter	Conditions	Min	Typ	Max	Unit
V_{RWM}	reverse standoff voltage		-	-	24	V
I_{RM}	reverse leakage current	$V_{RWM} = 24\text{ V}$	-	< 1	50	nA
V_{BR}	breakdown voltage	$I_R = 5\text{ mA}$	26.5	27.0	27.5	V
C_d	diode capacitance	$f = 1\text{ MHz}; V_R = 0\text{ V}$	-	23	50	pF
V_{CL}	clamping voltage		[1][2]			
		$I_{PP} = 1\text{ A}$	-	-	36	V
		$I_{PP} = 3\text{ A}$	-	-	70	V
r_{dyn}	dynamic resistance	$I_R = 10\text{ A}$	[2][3]	1.53	-	Ω

[1] Non-repetitive current pulse 8/20 μs exponential decay waveform according to IEC 61000-4-5.

[2] Measured from pin 1 to pin 2.

[3] Non-repetitive current pulse, Transmission Line Pulse (TLP) $t_p = 100\text{ ns}$; square pulse; ANS/IESD STM5-1-2008.

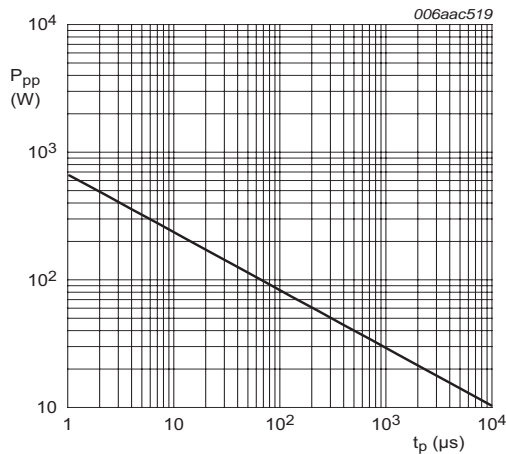

$T_{amb} = 25\text{ }^{\circ}\text{C}$

Peak pulse power dissipation as a function of pulse time; typical values

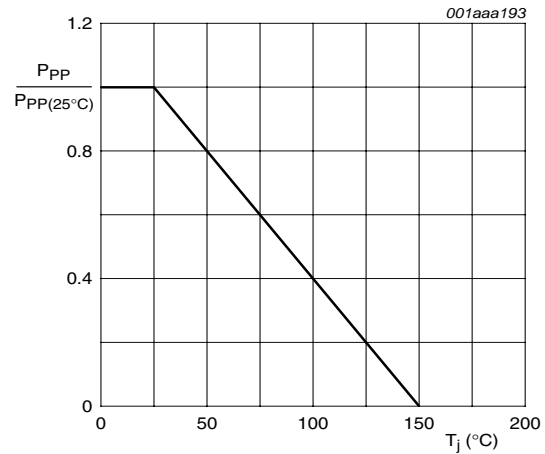

Relative variation of peak pulse power as a function of junction temperature; typical values

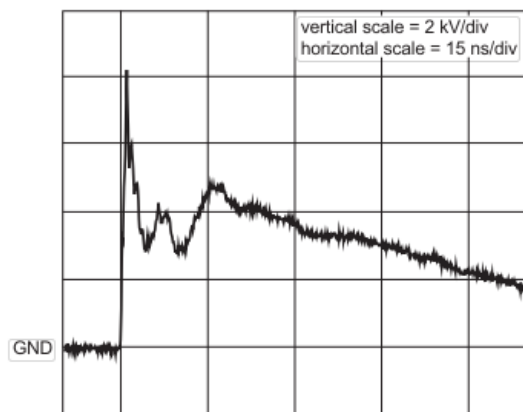

unclamped +8 kV ESD pulse waveform (IEC 61000-4-2 network)

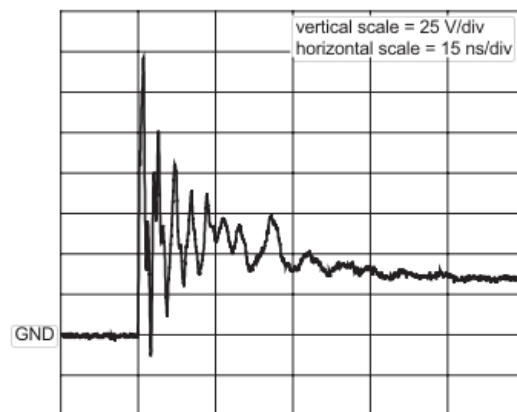

clamped +8 kV ESD pulse waveform (IEC 61000-4-2 network)

Outline Drawing – SOD-323

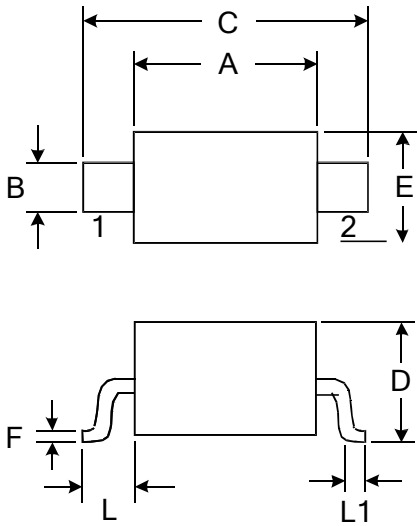

DIMENSIONS				
SYMBOL	MILLIMETER		INCHES	
	MIN	MAX	MIN	MAX
A	1.600	1.800	0.063	0.071
B	0.250	0.350	0.010	0.014
C	2.500	2.700	0.098	0.106
D		1.000		0.039
E	1.200	1.400	0.047	0.055
F	0.080	0.150	0.003	0.006
L	0.475 REF		0.019REF	
L1	0.250	0.400	0.010	0.016
H	0.000	0.100	0.000	0.004

Marking

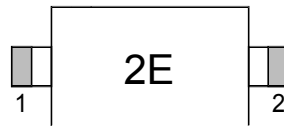

Ordering information

Order code	Package	Baseqty	Deliverymode
PESD24VS1UA	SOD-323	3000	Tape and reel