

MESSRS. : _____

AGENT : _____

**SPECIFICATION
OF
PYROELECTRIC PASSIVE
INFRARED SENSOR**

MODEL NO. : SBG446-671PART NO. : _____ **NIPPON CERAMIC CO., LTD.**

176-17 Hirooka, Tottori-shi, 689-1193 JAPAN
TEL : +81-857-53-4666 FAX : +81-857-53-3532

| APPROVED BY | CHECKED BY | DRAWN BY |
|-------------|------------|----------|
| | | |

| | | | | |
|---------------------------|------------------------|------------|---------------|---|
| MODEL NO. : SBG446-671 | DRAWING NO. 2012135 | REV : A | PAGE 1 / 8 | December 20, 2013 |
| PART NO. : | | | |  NIPPON CERAMIC CO., LTD. |

Scope

This specification describes a pyroelectric passive infrared sensor supplied by NIPPON CERAMIC CO.,LTD.

Type of sensor

Balanced differential(series opposed type.)

Physical configuration

- 1) Package : TO-5 metal can with dimensions shown in Figure 1-c (Ni-plated)
- 2) Element geometry : Four sensitive areas 1.0 mm * 1.0 mm and spaced 1.0 mm apart.
- 3) Element orientation : See Figure 1-b
- 4) Lead configuration : See Figure 1-c,1-d

Electrical characteristics (at 25 (+/-) 5 degC)

- 1) Circuit configuration : Three-terminal sensor with source follower
See Figure 2
- 2) Operating voltage : 3 ~ 10 V dc (Rs: 470kohm)
- 3) Element polarity : Element A,C:(+) B,D:(-) or A,C:(-) B,D:(+)
- 4) Source voltage : 0.35 ~ 1.4 V (Vd: 5V, Vs: 470kohm)

| | | | | |
|---------------------------|-------------|-------|-------|--|
| MODEL NO. : SBG446-671 | DRAWING NO. | REV : | PAGE | December 20, 2013 |
| PART NO. : | 2012135 | A | 2 / 8 |  NIPPON CERAMIC CO., LTD. |

5) Signal output : Min. 4.5 Vp-p (Typ. 6.5 Vp-p)
(S1, S2)

Signal output is measured at chopper frequency of 1 Hz when connected to the amplifier of gain 72.5 dB (at 1 Hz) and submitted to the emission of Infrared energy of 13 microW/cm² from 420 K Black Body.

See Figure 3

6) Noise output : Max. 250 mVp-p (Typ. 120 mVp-p)

Noise output shall be measured for 20 seconds when connected to the amplifier of gain 72.5 dB (at 1 Hz) and shut out from Infrared energy.

See Figure 3

7) Balance output : Max. 15 %

$$\left[\frac{|S1-S2|}{|S1+S2|} \right] \leq 0.15$$

S1 : Signal output on Element A + C

S2 : Signal output on Element B + D

Balance output is measured at chopper frequency of 1 Hz when connected to the amplifier of gain 72.5 dB (at 1 Hz) and submitted to the emission of Infrared energy of 13 microW/cm² from 420 K Black Body.

See Figure 3

8) Frequency response : 0.3 Hz to 3.0 Hz / (+/-) 10 dB

| | | | | |
|---------------------------|------------------------|------------|---------------|---|
| MODEL NO. : SBG446-671 | DRAWING NO. 2012135 | REV : A | PAGE 3 / 8 | December 20, 2013 |
| PART NO. : | | | |  NIPON CERAMIC CO., LTD. |

Optical characteristics

- 1) Field of view : 132 ° from center of element on axis x,y
: 146 ° from center of element on 45 °
: See Figure 1-a
- 2) Filter substrate : Silicon
- 3) Cut on (5 %T ABS) : 5.5 (+/-) 0.5 microm
- 4) Transmission : \geq 70 % average 8 to 13 microm

Environmental requirements

- 1) Operating temperature : -30 degC to +70 degC
- 2) Storage temperature : -40 degC to +80 degC
- 3) Relative humidity :
The sensor shall operate without increase in noise output when exposed to 90 ~ 95 % RH at 30 degC continuously.
- 4) Hermetic seal :
The sensor shall be sealed to withstand a vacuum of 21.28 kPa.

RoHS compliance

This product conforms to the RoHS Directive in force at the date of issuance of this Specification Sheet.

| | | | | |
|---------------------------|-------------|-------|-------|---|
| MODEL NO. : SBG446-671 | DRAWING NO. | REV : | PAGE | December 20, 2013 |
| PART NO. : | 2012135 | A | 4 / 8 |  NIPON CERAMIC CO., LTD. |

Configuration (Figure 1)

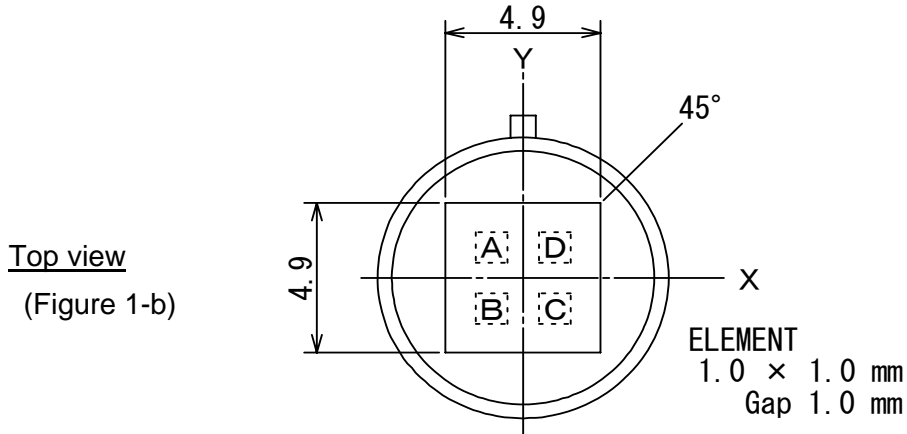
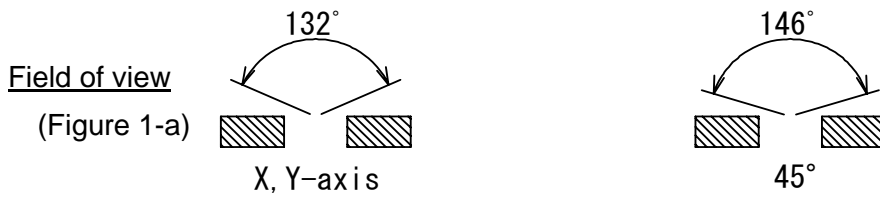

Element Polarity

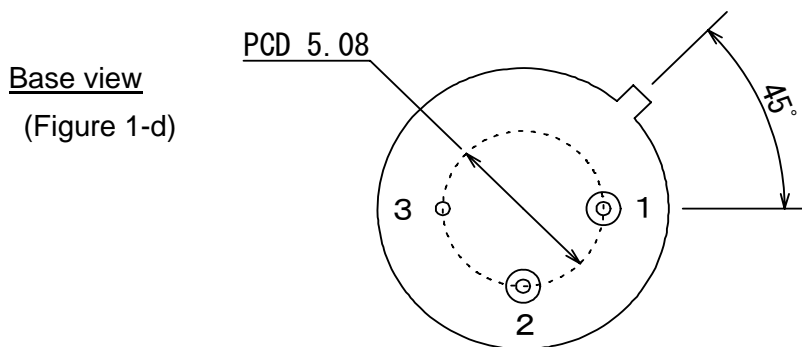
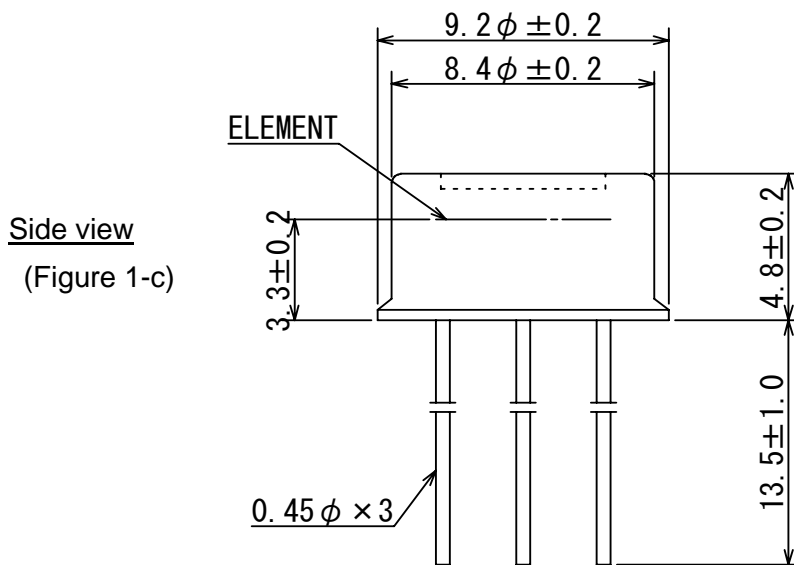
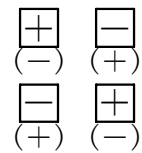

- 1: Drain
- 2: Source
- 3: Ground

unit : mm

| | | | | |
|---------------------------|------------------------|------------|---------------|--------------------------|
| MODEL NO. : SBG446-671 | DRAWING NO. 2012135 | REV : A | PAGE 5 / 8 | December 20, 2013 |
| PART NO. : | | | | NIPPON CERAMIC CO., LTD. |

Circuit configuration (Figure 2)

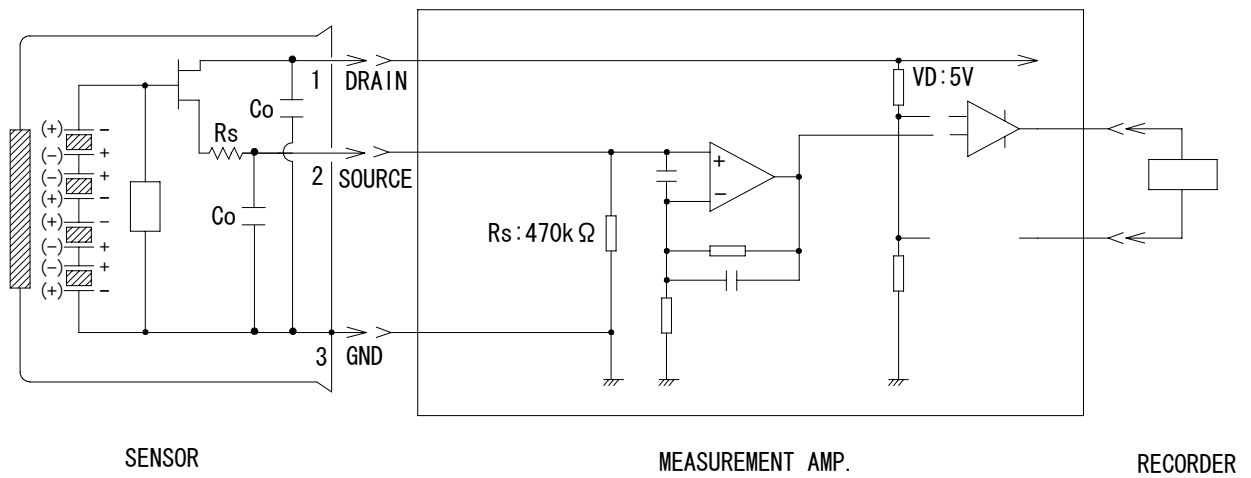

※ Measurement Amp.: Non-inverted type, gain 72.5 dB at 1 Hz , 0.4 to 2.7 Hz / -3 dB

Test set-up block diagram (Figure 3)

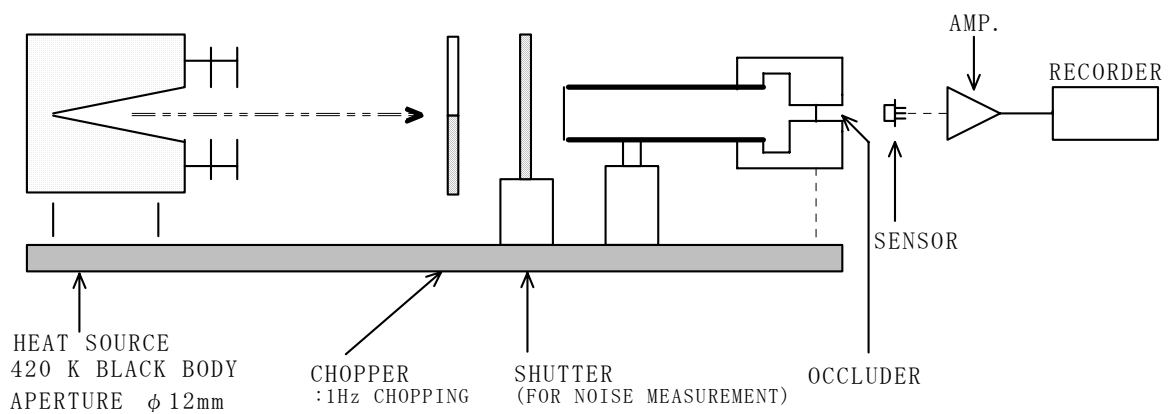

Occluder position

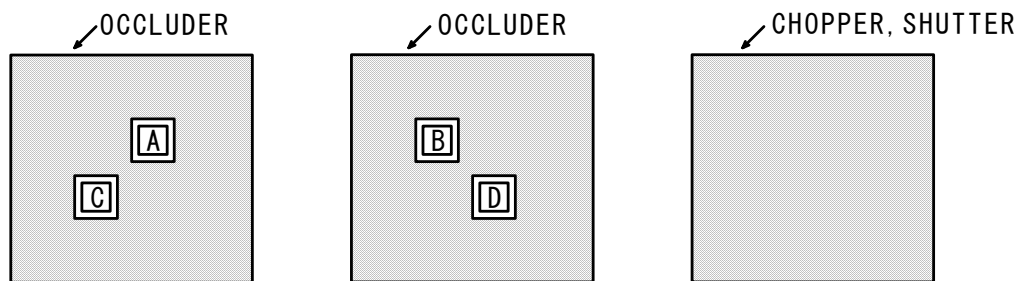

Signal output 1 (S1)

Signal output 2 (S2)

Noise output

| | | | | |
|---------------------------|------------------------|------------|---------------|--------------------------|
| MODEL NO. : SBG446-671 | DRAWING NO. 2012135 | REV : A | PAGE 6 / 8 | December 20, 2013 |
| PART NO. : | | | | NIPPON CERAMIC CO., LTD. |

※ Notes

1.Design restrictions/precautions

If used for outdoor applications, be sure to apply suitable supplementary optical filter and drip-proof, anti-dew construction. This sensor is designed for indoor use.

in cases where secondary accidents due to operation failure or malfunctions can be anticipated, add a fail safe function to the design.

2.Usage restrictions/precautions

To prevent sensor malfunctions, operational failure or any deterioration of its characteristics, do not use this sensor in the following, or similar, conditions.

- a. In rapid environmental temperature changes.
- b. In strong shock or vibration.
- c. In a place where there are obstructing materials (glass,fog,etc.) Through which Infrared rays cannot pass within detection area.
- d. In fluid, corrosive gases and sea breeze.
- e. Continual use in high humidity atmosphere.
- f. Exposed to direct sun light or headlights of automobiles.
- g. Exposed to direct wind from a heater or air conditioner.

3.Assembly restrictions/precautions

Soldering _____

- a. Use soldering irons when soldering.
- b. Avoid keeping pins of this sensor hot for a long time as excessive heat may cause deterioration of its quality.(e.g. within 5 sec. at 350 degC)

Washing _____

- a. Be sure to wash out all flux after soldering as remainder may cause malfunctions.
- b. Use a brush when washing. Washing with an ultrasonic cleaner may cause operational failure.

| | | | | |
|---------------------------|------------------------|------------|---------------|---|
| MODEL NO. : SBG446-671 | DRAWING NO. 2012135 | REV : A | PAGE 7 / 8 | December 20, 2013 |
| PART NO. : | | | |  NIPPON CERAMIC CO., LTD. |

4.Handling and storage restrictions/precautions

To prevent sensor malfunctions, operational failure, appearance damage or any deterioration of its characteristics, do not expose this sensor to the following or similar, handling and storage conditions.

- a. Vibration for a long time.
- b. Strong shock.
- c. Static electricity or strong electromagnetic waves.
- d. High temperature and humidity for a long time.
- e. Corrosive gases or sea breeze.
- f. Dirty and dusty environments that may contaminate the optical window.

5.Restrictions on product use

The product described in this document shall not be used or embedded to any downstream products of which manufacture, use and/or sales are prohibited under any applicable laws and regulations.

Sensor troubles resulting from misuse, inappropriate handling or storage are not the manufacturer's responsibility.

| | | | | |
|---------------------------|-------------|-------|-------|---|
| MODEL NO. : SBG446-671 | DRAWING NO. | REV : | PAGE | December 20, 2013 |
| PART NO. : | 2012135 | A | 8 / 8 |  NIPPON CERAMIC CO., LTD. |