

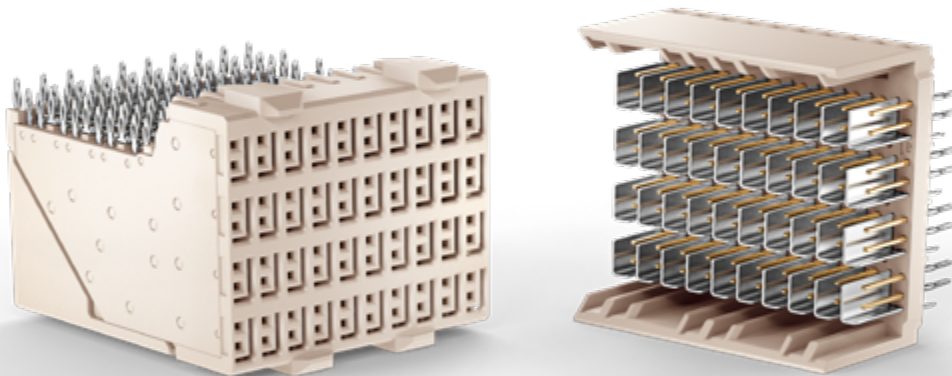

# ERmet ZD

## High Speed Connector System



## ERmet ZD High Speed Differential Hard Metric Connector System

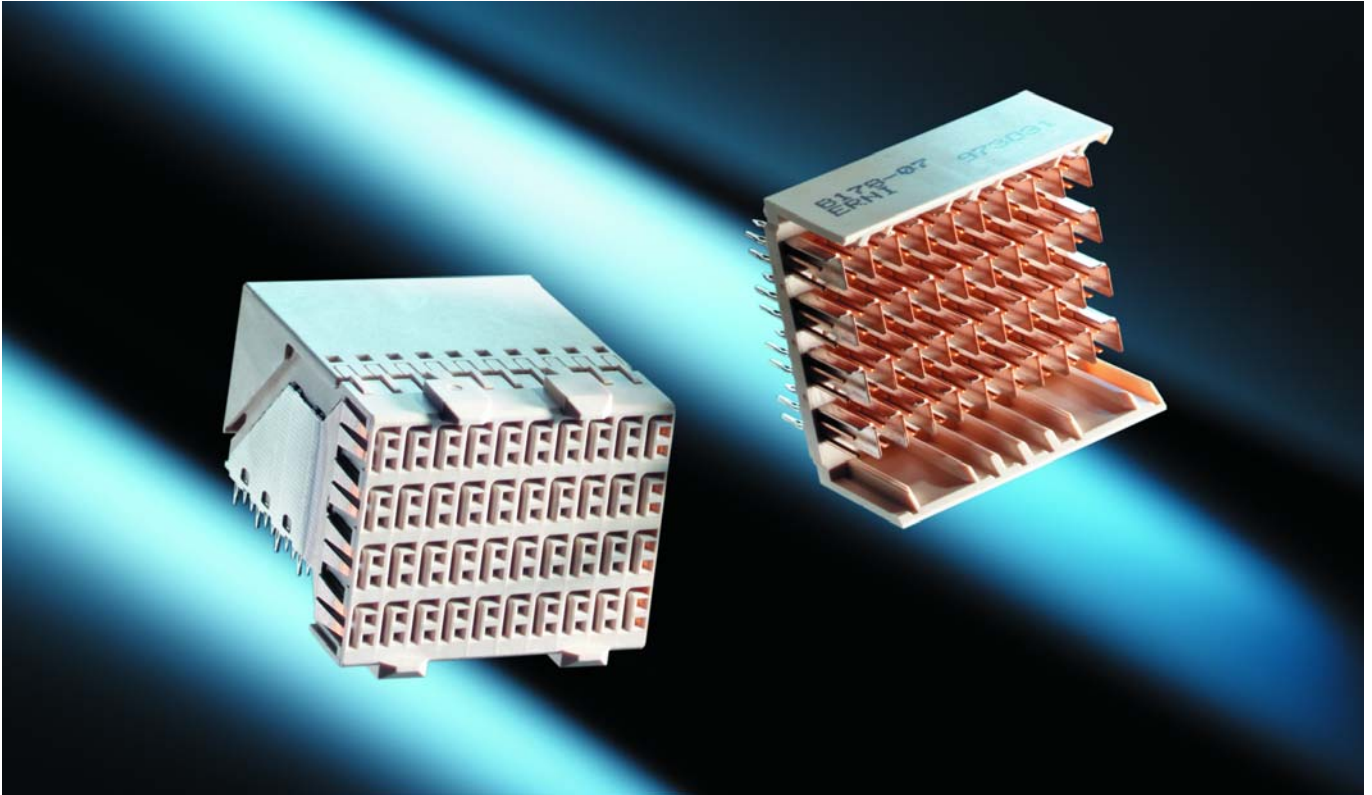

ERmet ZD Male and Female Module with Pressfit Termination

### Description

The ERmet ZD is specifically designed for high speed differential signaling in telecom applications at data rates of up to 5 Gbits/second. This robust, high performance, modular connector system is also designed to be used in conjunction with the 2 mm Hard Metric (IEC 61076-4-101) family of connectors. It shares the chassis and board design features along with common layout references.

The connector meets the electrical performance requirements of high speed, low voltage differential signaling. The ERmet ZD connector family is available in pressfit versions. The back-plane module is a male pin header that has three mating levels. The ground shield and signal pins mate sequentially at 1.5 mm intervals.

The robust mechanical design and excellent signal integrity are a result of the internal differential shielding scheme and the "L" shaped male shield blades. The inherently rigid male shields stand higher than the signal pins and surround each pair. An improved guidance feature completes the rugged mechanical design.

Optimized grid design to improve the RF characteristics.  
Easy and economical trace routing achieved by in-line-design of signal and ground pins.

Simulation models available upon request.

### Technical Features

- Design: Wafers with individually shielded pairs of contacts.
- Contacts: Low noise, dual beam, leaf contacts with one ground blade for every pair of signals.
- Wafer pitch: 2.5 mm from wafer to wafer.
- Pitch between signal pins: 1.5 mm between pairs (within wafer).
- Pitch between pairs: 4.5 mm (within wafer).
- Ground arrangement: In line with signals at termination and surrounding shield.
- Multiline Crosstalk < 3% at 100 ps
- Differential Impedance:  $100 \Omega \pm 10\%$
- Power Modules: Closed entry, vertical female backplane modules with stamped blades.
- Alignment Features: Improved pre-alignment guide and polarizing features, 4 rigid blades for all modules.
- Modularity: Modules are available in two widths and a variety of lengths to integrate within typical Eurocard designs utilizing 5 and 8 row, 2 mm HM connectors to IEC 61076-4-101.

## ERmet ZD

### High Speed Differential Hard Metric Connector System

#### Electrical and Mechanical Characteristics



	Standard	Pressfit Male- and Female
Number of pins		2-, 3- and 4-pair
<b>Technical data</b>		
Climate category	DIN EN 60068-1 test b	-55/125/56
Temperature range		-55/125 °C
Current rating	IEC60512 test 5b	By ambient temperature: 20 °C 0.9 A 70 °C 0.7 A 100 °C 0.4 A
Clearance and creepage distance		0.5 mm
Voltage rating	IEC 60664	Has to be determined according to client-specific using case (degree of environmental pollution) according to IEC 60664
Dielectric strength	IEC 60512 test 4a	contact pair - contact pair 500 V <sub>rms</sub> contact pair - shield 500 V <sub>rms</sub>
Contact resistance	IEC 60512 test 2a	< 50 mΩ (Signal) < 15 mΩ (Shield)
Insulation resistance	IEC 60512 test 3a	> 10 <sup>4</sup> MΩ
Vibration, sine	IEC 60512 test 6d	10 – 2000 Hz 20 g
Contact interruption (while vibration test)	IEC 60512 test 2e	< 1 μs
Shock, halfsine	IEC 60512 test 6c	50 g 11 ms
Contact interruption (while shock test)	IEC 60512 test 2e	< 1 μs
Mechanical operation (mating cycles)	IEC 60512 test 9a	> 250 mating cycles
Insertion and withdrawal force	IEC 60512 test 13b	Insertion force: max. 0.7 N/pin (Signal) max. 0.9 N/pin (Shield) Withdrawal force: min. 0.15 N/pin
Gauge retention force	IEC 60512 test 16e	> 0.2 N

# ERmet ZD

## High Speed Differential Hard Metric Connector System

### Electrical and Mechanical Characteristics



	Standard	Pressfit Male- and Female
Number of pins		2-, 3- and 4-pair
<b>Signal transmission data</b>		
Multiline Crosstalk		< 3% at 100 ps
Insertion Loss		< 1 dB up to 3 GHz
Differential impedance		100 $\Omega$ $\pm$ 10%
Propagation delay		A pin 97 $\pm$ 10 ps B pin 107 $\pm$ 10 ps C pin 125 $\pm$ 10 ps D pin 134 $\pm$ 10 ps E pin 157 $\pm$ 10 ps F pin 166 $\pm$ 10 ps G pin 187 $\pm$ 10 ps H pin 199 $\pm$ 10 ps
<b>Process-conditions</b>		
Press-in force		36 N/pin
Warning		Soldering of pressfit connectors not recommended.
<b>Materials</b>		
Housing: Plastic material (symbol)		LCP
CTI value	IEC 112	CTI 175
UL flame rating		UL 94 V-0
UL file		E83005
<b>Contact and mating area</b>		
Base material		Cu alloy
Plating		min. 0.65 $\mu$ m PdNi + 0.1 $\mu$ m Au over 2 - 3 $\mu$ m Ni 0.76 $\mu$ m Au over 1.27 $\mu$ m Ni (Right Angle Male RoHS 5/6)
<b>Termination area</b>		
Base material		Cu alloy
Plating		0.5 - 2 $\mu$ m Sn matt over 2 - 3 $\mu$ m Ni 0.5 $\mu$ m SnPb over 1.27 $\mu$ m Ni (Right Angle Male RoHS 5/6)
<b>Environment compatibility</b>		
Recycling		no flame-retardent additives, no toxic additives, allow easy recycling
<b>Product-approval</b>		
UL		E84703



# ERmet ZD

## High Speed Differential Hard Metric Connector System

### Right Angle Female Connectors 4 Pair

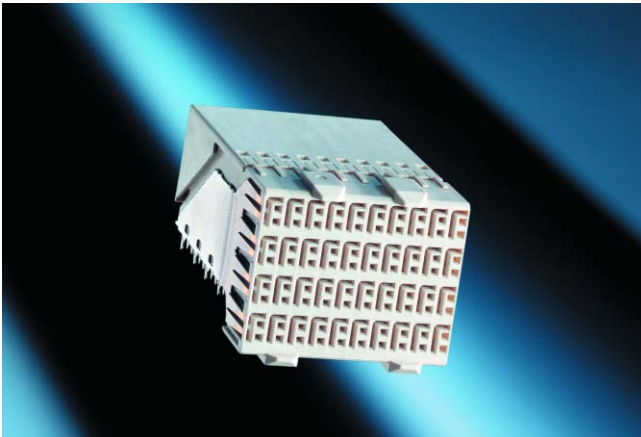

The ERmet ZD 4 pair female connector provides in the 10 wafer version 40 contact pairs (80 signal contacts and 40 ground contacts).

The female pair 4 is available with pressfit termination. Additionally, the ERmet ZD 4 pair female connector has four pre-alignment pegs which provide easier alignment, improved rigidity and reliable polarisation. The layout grid facilitates integration with conventional 2 mm HM (IEC 061076-4-101) connectors.

### Dimensional Drawing

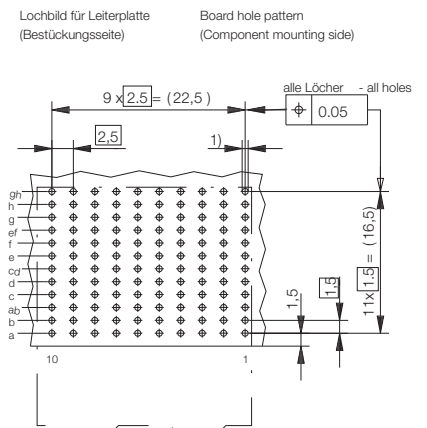
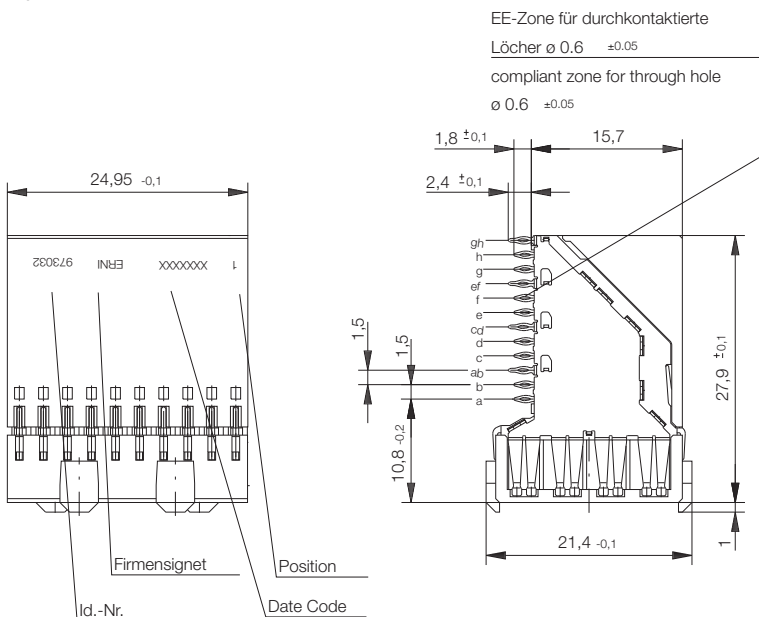
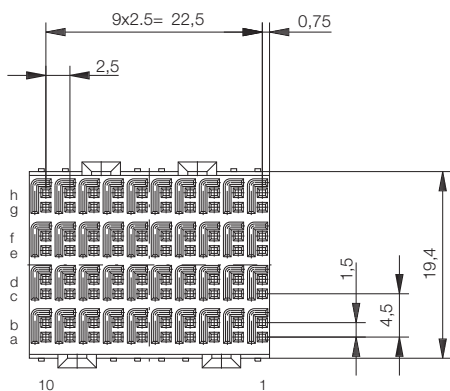



- 1)  $\phi 0.6 \pm 0.05$  Durchmesser des metallisierten Loches  
 $\phi 0.6 \pm 0.05$  Diameter of finished plated-through hole
- $\phi 0.7 \pm 0.02$  Bohrungsdurchmesser des Loches  
 $\phi 0.7 \pm 0.02$  Diameter of drilled hole

All dimensions in mm

**ERmet ZD**  
**High Speed Differential Hard Metric Connector System**  
**Right Angle Female Connectors 4 Pair**

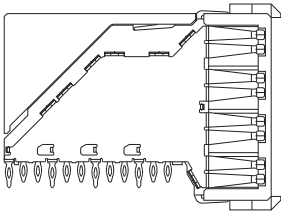

**Ordering Information**

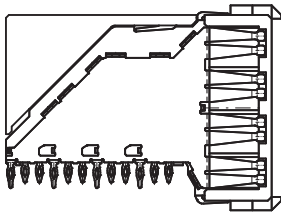
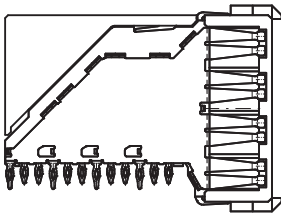
Configuration	Length	Pin Configuration	Termination	Termination Tail Length	Used For	No. of Pins	Part Number
 4 Pair / 10 wafers	25 mm	40 pairs - 80 signals / 40 grounds	 Pressfit	1.8 mm	Zone 2	120	<b>973032</b>
 4 Pair / 12 wafers	30 mm	48 pairs - 96 signals / 48 grounds	Pressfit	1.8 mm	–	144	<b>973099 *</b>
 4 Pair / 15 wafers	37.5 mm	60 pairs - 120 signals / 60 grounds	Pressfit	1.8 mm		180	<b>973024 *</b>

\* Parts available as kit.

# ERmet ZD

## High Speed Differential Hard Metric Connector System

### Right Angle Female Connectors 3 Pair

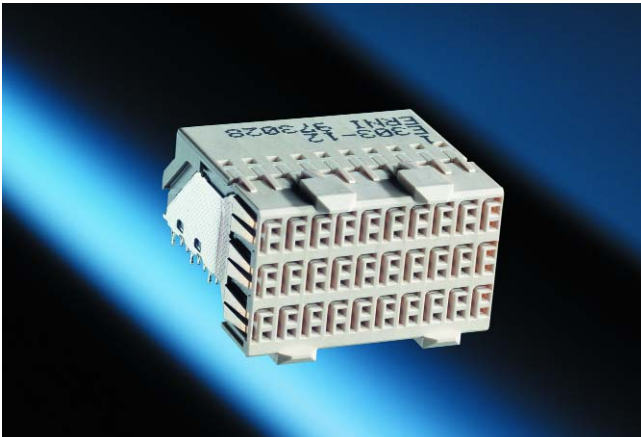

The ERmet ZD 3 pair female connector provides in the 10 wafer version 30 contact pairs (60 signal contacts and 30 ground contacts).

The female 3 pair is available with pressfit termination. Additionally, the ERmet ZD 3 pair female connector has four pre-alignment pegs which provide easier alignment, improved rigidity and reliable polarisation. The layout grid facilitates integration with conventional 2 mm HM (IEC 061076-4-101) connectors.

### Dimensional Drawing

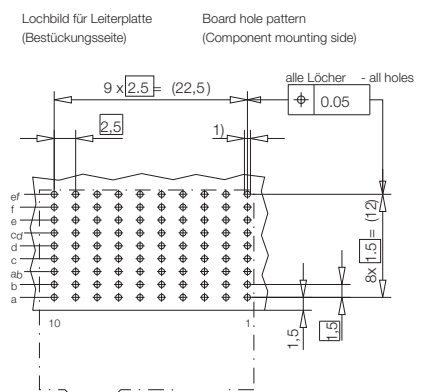
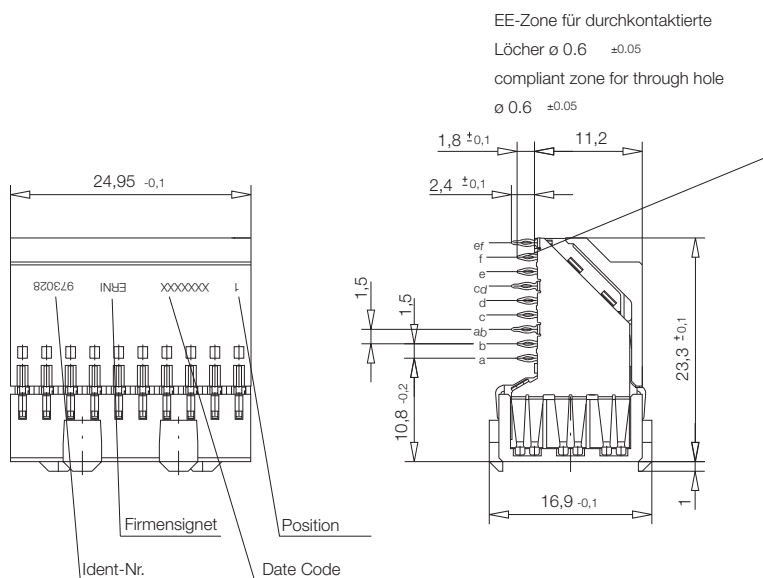
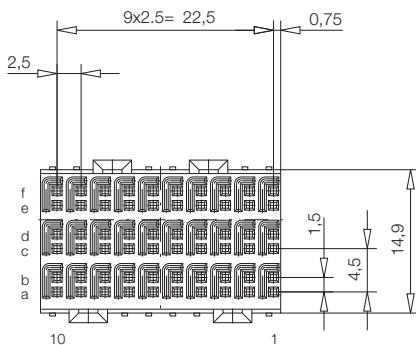



- 1)  $\phi 0.6 \pm 0.05$  Durchmesser des metallisierten Loches
- $\phi 0.6 \pm 0.05$  Diameter of finished plated-through hole
- $\phi 0.7 \pm 0.02$  Bohrungsdurchmesser des Loches
- $\phi 0.7 \pm 0.02$  Diameter of drilled hole

All dimensions in mm

**ERmet ZD**  
**High Speed Differential Hard Metric Connector System**  
**Right Angle Female Connectors 3 Pair**

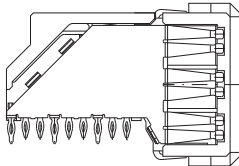

**Ordering Information**

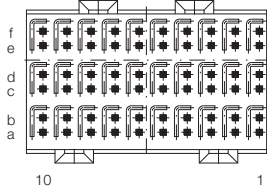
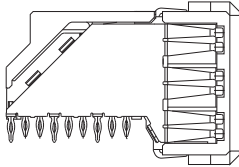
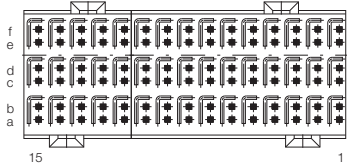
Configuration	Length	Pin Configuration	Termination	Termination Tail Length	Used For	No. of Pins	Part Number
							
3 Pair / 10 wafers	25 mm	30 pairs - 60 signals / 30 grounds	Pressfit	1.8 mm	ADF	90	<b>973028</b>
							
3 Pair / 15 wafers	37.5 mm	45 pairs - 90 signals / 45 grounds	Pressfit	1.8 mm	—	135	<b>973020</b>

# ERmet ZD

## High Speed Differential Hard Metric Connector System

### Right Angle Female Connectors 2 Pair



The ERmet ZD 2 pair female connector provides in the 10 wafer version 20 contact pairs (40 signal contacts and 20 ground contacts).

The female 2 pair is available with pressfit termination. Additionally, the ERmet ZD 2 pair female connector has four pre-alignment pegs which provide easier alignment, improved rigidity and reliable polarisation. The layout grid facilitates integration with conventional 2 mm HM (IEC 061076-4-101) connectors.

### Dimensional Drawing

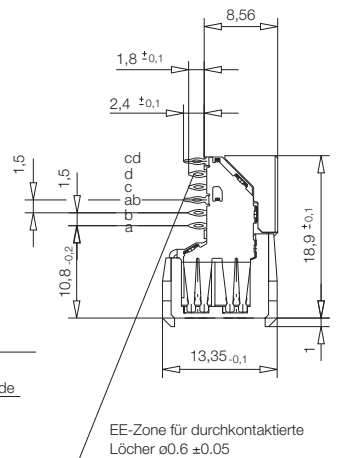
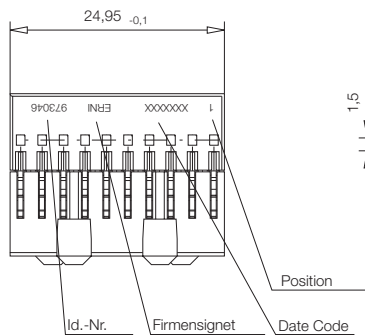
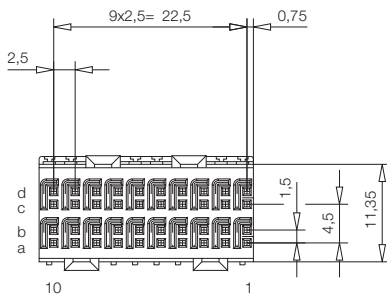

EE-Zone für durchkontaktierte Löcher  $\phi 0.6 \pm 0.05$   
 compliant zone for through hole  $\phi 0.6 \pm 0.05$

Lochbild für Leiterplatte (Bestückungsseite) Board hole pattern (Component mounting side)

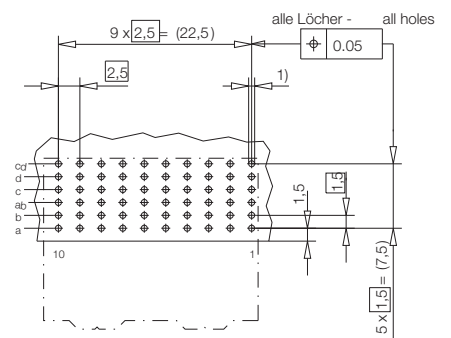

1)  $\phi 0.6 \pm 0.05$  Durchmesser des metallisierten Loches  
 $\phi 0.6 \pm 0.05$  Diameter of finished plated-through hole  
 $\phi 0.7 \pm 0.02$  Bohrungsdurchmesser des Loches  
 $\phi 0.7 \pm 0.02$  Diameter of drilled hole

All dimensions in mm

**ERmet ZD**  
**High Speed Differential Hard Metric Connector System**  
**Right Angle Female Connectors 2 Pair**

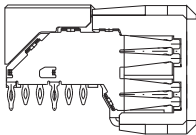
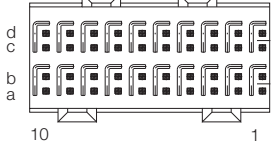

**Ordering Information**

Configuration	Length	Pin Configuration	Termination	Termination Tail Length	Used For	No. of Pins	Part Number
							
2 pair / 10 wafers	25 mm	20 pairs - 40 signals / 20 grounds	Pressfit	1.8 mm	–	60	<b>973046</b>



# ERmet ZD High Speed Differential Hard Metric Connector System Vertical Male Connectors 4 Pair



The ERmet ZD 4 pair male connector provides in the 10 wafer version 40 contact pairs (80 signal contacts and 40 ground contacts). This series supports three levels of sequential mating.

The male 4 pair is available with pressfit termination. The "L" shaped shields are robust mechanical structures that provide an ideal differential environment as well as protecting the signal pins and resisting deflection that could cause stubbing. Various module length are offered in four pair wide configuration. The layout grid facilitates integration with conventional 2 mm HM (IEC 061076-4-101) connectors.

## Dimensional Drawing

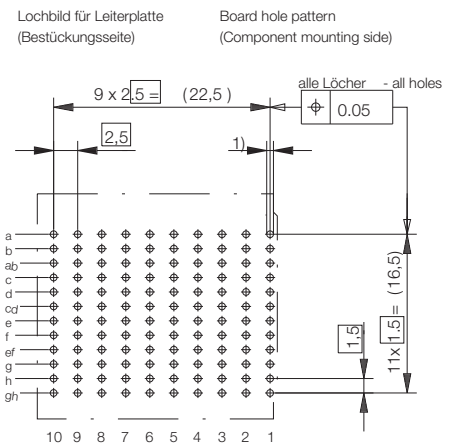
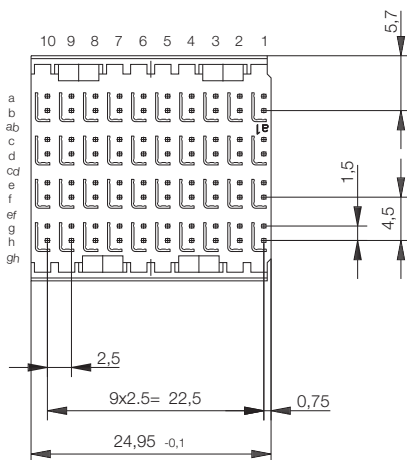
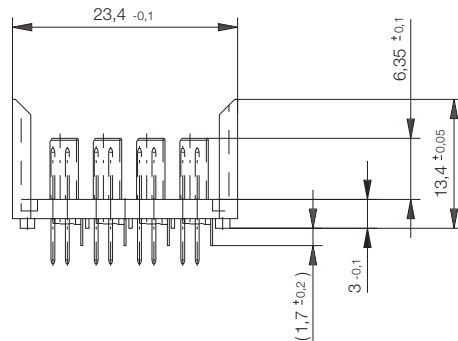
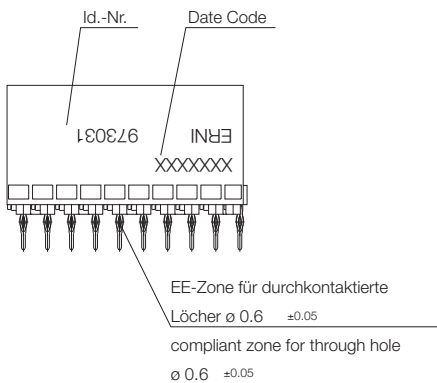

- 1)  $\varnothing 0.6 \pm 0.05$  Durchmesser des metallisierten Loches  
 $\varnothing 0.6 \pm 0.05$  Diameter of finished plated-through hole
- $\varnothing 0.7 \pm 0.02$  Bohrungsdurchmesser des Loches  
 $\varnothing 0.7 \pm 0.02$  Diameter of drilled hole

All dimensions in mm

# ERmet ZD

## High Speed Differential Hard Metric Connector System

### Vertical Male Connectors 4 Pair

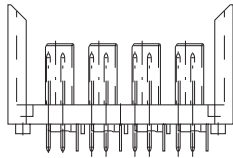
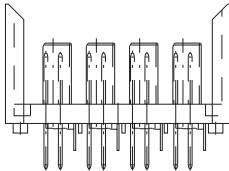
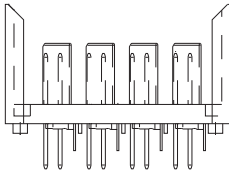

#### Ordering Information

Configuration	Length	Pin Configuration	Termination	Termination Tail Length	Used For	No. of Pins ERmet	Part Number
	25 mm	40 pairs - 80 signals / 40 grounds	Pressfit	1.7 mm	-	120	<b>973061</b>
	25 mm	40 pairs - 80 signals / 40 grounds	Pressfit	3.7 mm	Zone 2	120	<b>973031</b>
	30 mm	48 pairs - 96 signals / 48 grounds	Pressfit	3.7 mm	-	144	<b>973096</b>

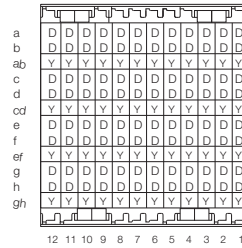
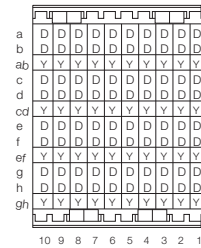
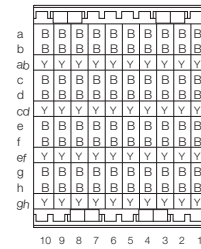

#### Signal Pins

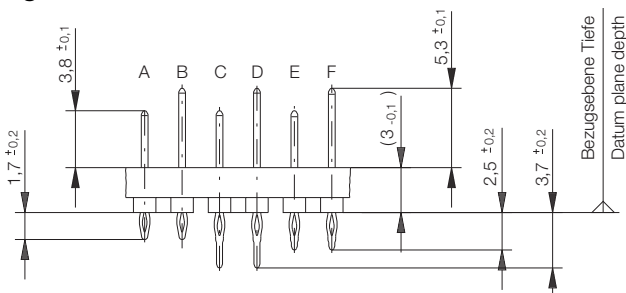

#### Shielding Pins

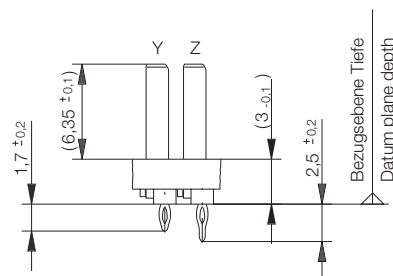

**ERmet ZD**  
**High Speed Differential Hard Metric Connector System**  
**Vertical Male Connectors 4 Pair**



**Ordering Information**

Configuration	Length	Pin Configuration	Termination	Termination Tail Length	Used For	No. of Pins	Part Number
4 Pair / 15 wafers	37.5 mm	60 pairs - 120 signals / 60 grounds	Pressfit	3.7 mm	-	180	<b>973023</b>

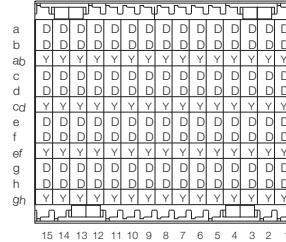
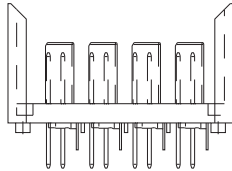

**Signal Pins**

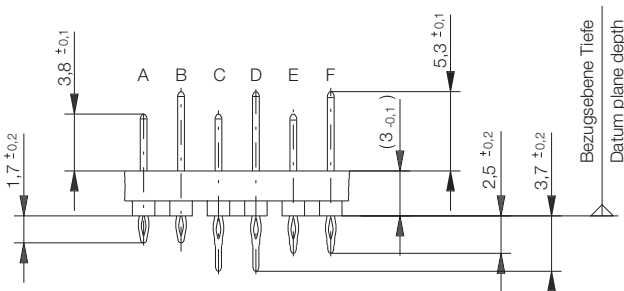

**Shielding Pins**

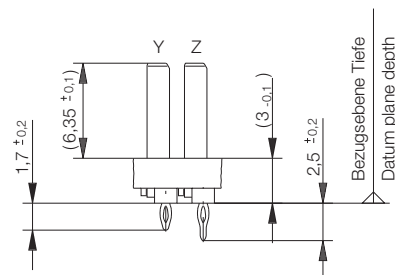

# ERmet ZD

## High Speed Differential Hard Metric Connector System

### Vertical Male Connectors 3 Pair

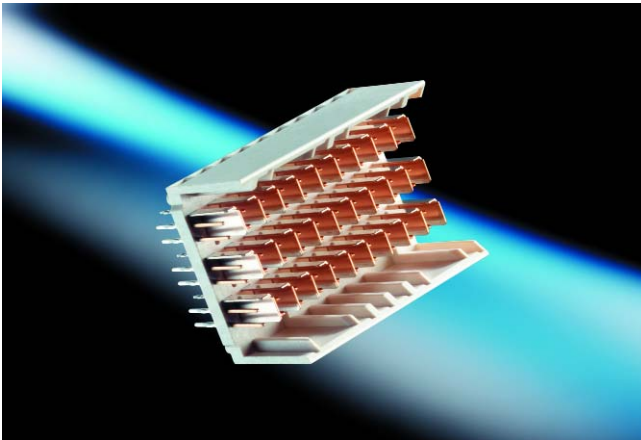

The ERmet ZD 3 pair male connector provides in the 10 wafer version 30 contact pairs (60 signal contacts and 30 ground contacts). This series supports three levels of sequential mating.

The male 3 pair is available with pressfit termination. The "L" shaped shields are robust mechanical structures that provide an ideal differential environment as well as protecting the signal pins and resisting deflection that could cause stubbing. Various module length are offered in three pair wide configuration. The three pair wide version is ideal for Eurocard back-plane designs with 2 mm card spacing.

### Dimensional Drawing

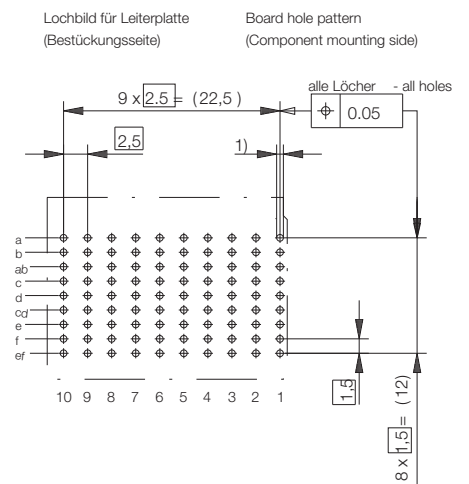
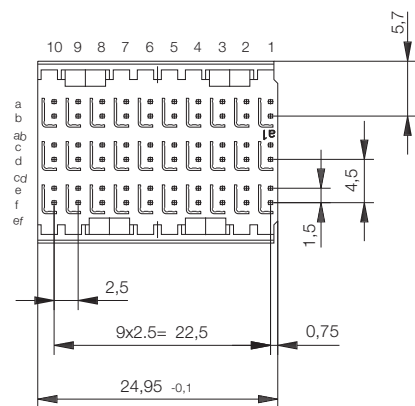
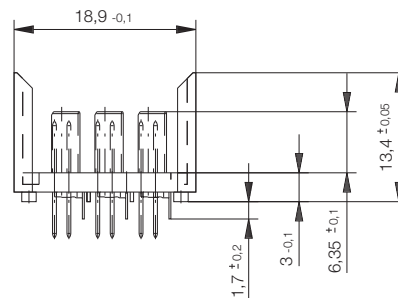
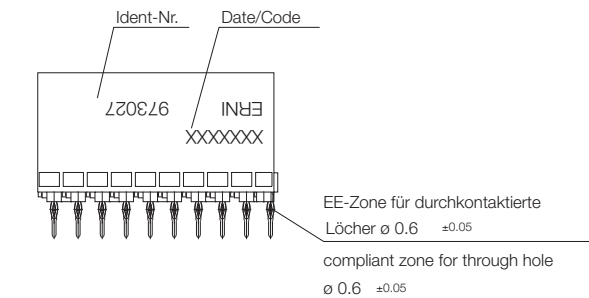

All dimensions in mm

# ERmet ZD

## High Speed Differential Hard Metric Connector System

### Vertical Male Connectors 3 Pair

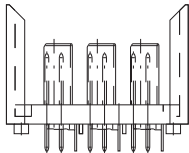
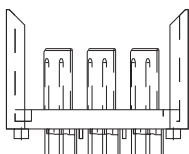
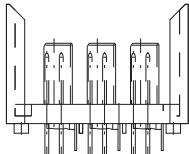

### Ordering Information

Configuration	Length	Pin Configuration	Termination	Termination Tail Length	Used For	No. of Pins	Part Number
	25 mm	30 pairs - 60 signals / 30 grounds	Pressfit	1.7 mm	-	90	<b>973062</b>
	25 mm	30 pairs - 60 signals / 30 grounds	Pressfit	2.5 mm	-	90	<b>223396</b>
	25 mm	30 pairs - 60 signals / 30 grounds	Pressfit	3.7 mm	-	90	<b>973027</b>

### Signal Pins

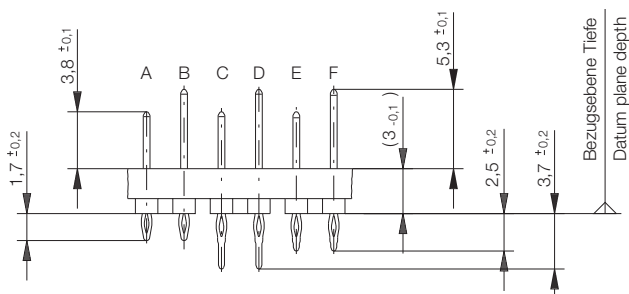

### Shielding Pins

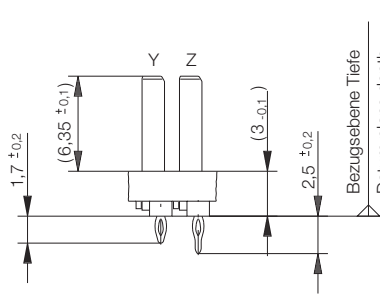

**ERmet ZD**  
**High Speed Differential Hard Metric Connector System**  
**Vertical Male Connectors 3 Pair**



**Ordering Information**

Configuration	Length	Pin Configuration	Termination	Termination Tail Length	Used For	No. of Pins	Part Number
3 Pair / 15 wafers	37.5 mm	45 pairs - 90 signals / 45 grounds	Pressfit	3.7 mm	-	135	<b>973019</b>

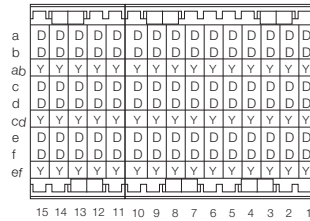
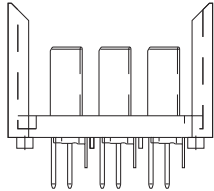

**Signal Pins**

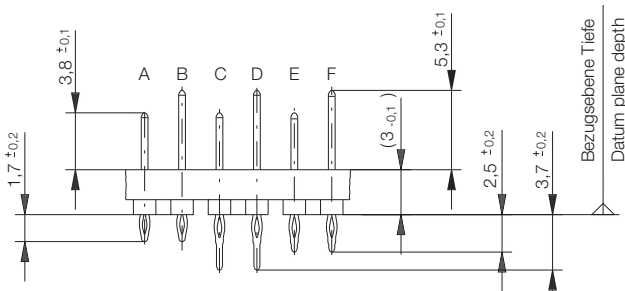

**Shielding Pins**

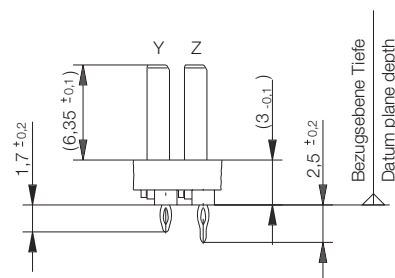



# ERmet ZD

## High Speed Differential Hard Metric Connector System

### Vertical Male Connectors 2 Pair

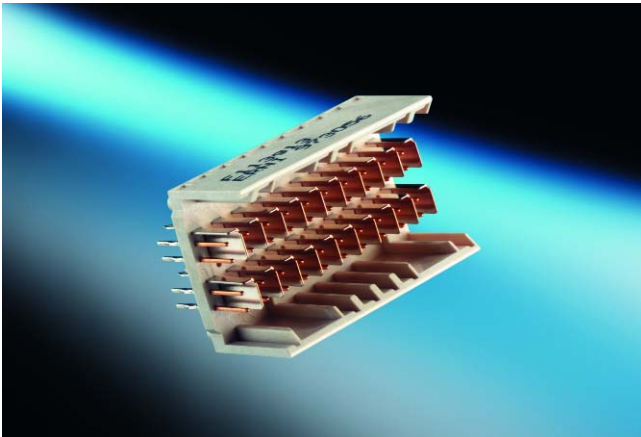

The ERmet ZD 2 pair male connector provides in the 10 wafer version 20 contact pairs (40 signal contacts and 20 ground contacts). This series supports three levels of sequential mating.

The male 2 pair is available with pressfit termination. The "L" shaped shields are robust mechanical structures that provide an ideal differential environment as well as protecting the signal pins and resisting deflection that could cause stubbing. Various module length are offered in two pair wide configuration. The two pair wide version is ideal for applications in combination with ERmet 5+2 connectors because of the same width of 15.4 mm.

### Dimensional Drawing

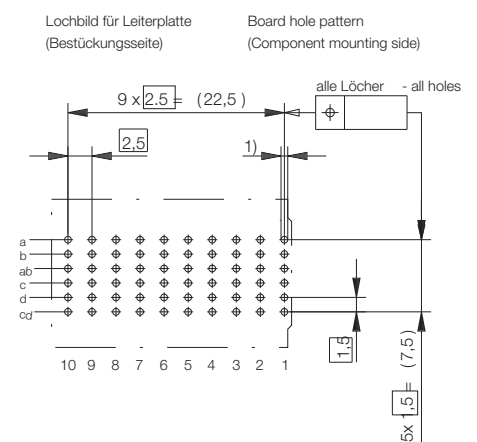
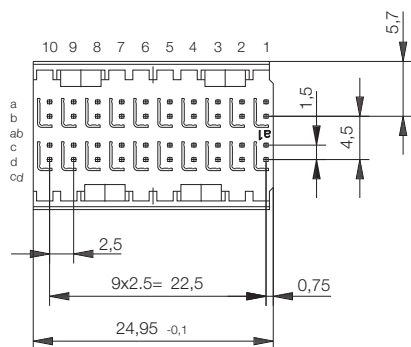
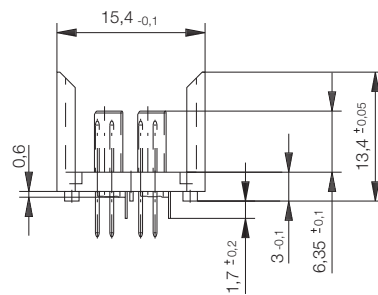
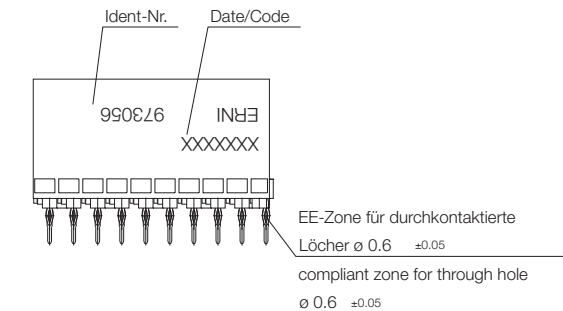

- 1)  $\phi 0.6 \pm 0.05$  Durchmesser des metallisierten Loches  
 $\phi 0.6 \pm 0.05$  Diameter of finished plated-through hole
- $\phi 0.7 \pm 0.02$  Bohrungsdurchmesser des Loches  
 $\phi 0.7 \pm 0.02$  Diameter of drilled hole

All dimensions in mm

# ERmet ZD

## High Speed Differential Hard Metric Connector System

### Vertical Male Connectors 2 Pair

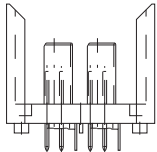
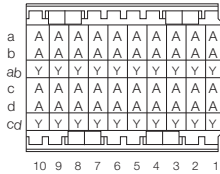
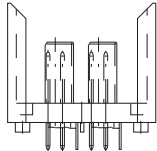
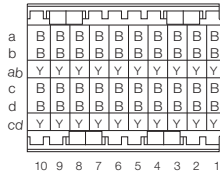
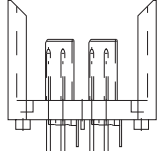
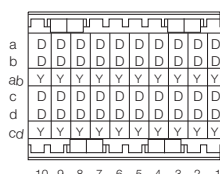

### Ordering Information

Configuration	Length	Pin Configuration	Termination	Termination Tail Length	Used For	No. of Pins	Part Number
 2 pair / 10 wafers	25 mm	20 pairs - 40 signals / 20 grounds	Pressfit	1.7 mm	-	60	
							<b>973080</b>
 2 pair / 10 wafers	25 mm	20 pairs - 40 signals / 20 grounds	Pressfit	1.7 mm	-	60	
							<b>973063</b>
 2 pair / 10 wafers	25 mm	20 pairs - 40 signals / 20 grounds	Pressfit	3.7 mm	-	60	
							<b>973056</b>

### Signal Pins

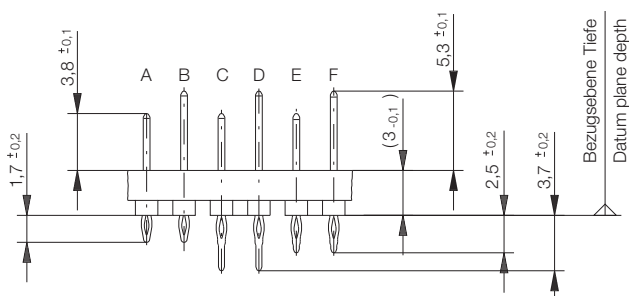

### Shielding Pins

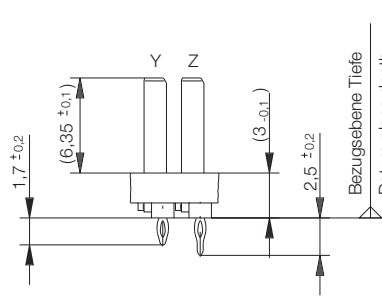

# ERmet ZD

## High Speed Differential Hard Metric Connector System

### Right Angle Male Connectors 4 Pair

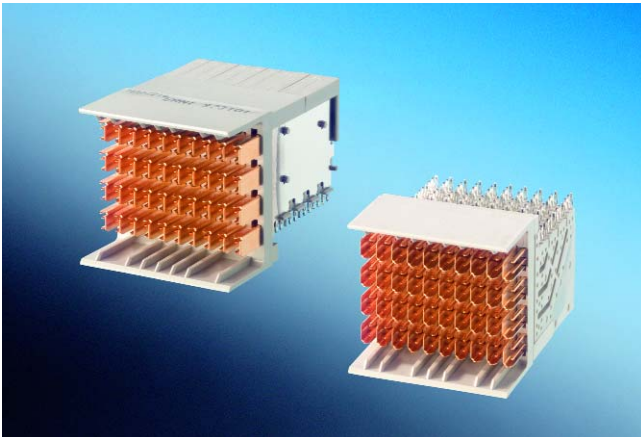

The ERmet ZD 4 pair right angle male connector provides in the 10 wafer version 40 contact pairs and is available with pressfit termination. The connector is designed for high speed differential applications and is an extension of the ERmet 2 mm HM product line.

The 4 pair right angle male connector can be used as an AdvancedTCA® Zone 3 connector in conjunction with the Zone 2 right angle female connector.

### Dimensional Drawing

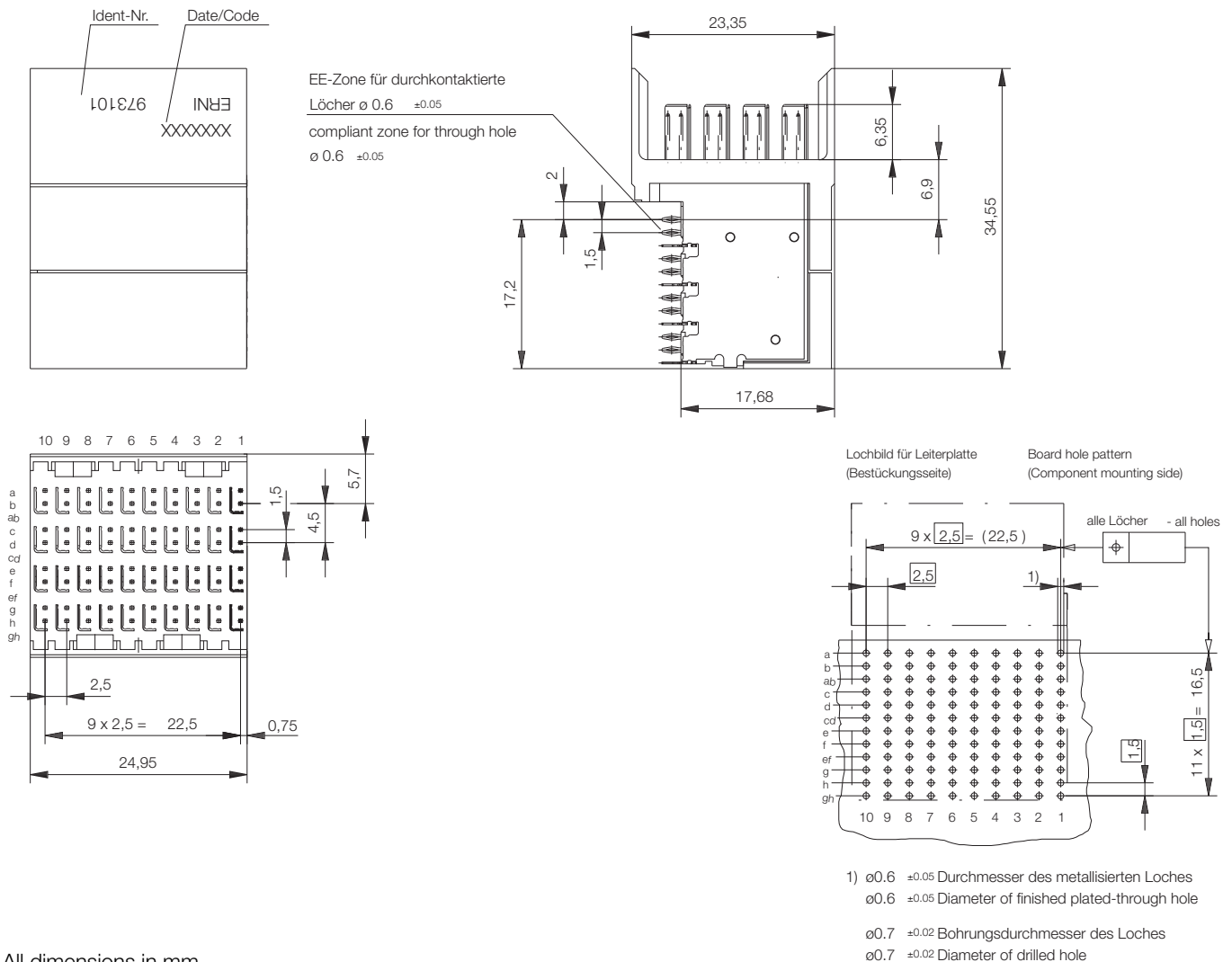

All dimensions in mm

**ERmet ZD**  
**High Speed Differential Hard Metric Connector System**  
**Right Angle Male Connectors 4 Pair**

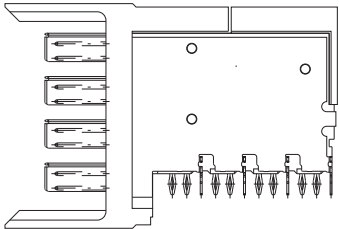
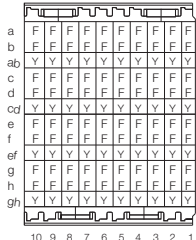

**Ordering Information**

Configuration	Length	Pin Configuration	Termination	Termination Tail Length	Used For	No. of Pins	Part Number
	25 mm		Pressfit	–	–	120	<b>973101</b>
4 Pair / 10 wafers		40 pairs - 80 signals / 40 grounds					

**Signal Pins**

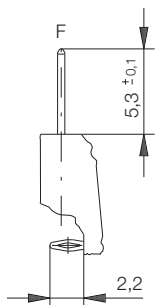

**Shielding Pins**

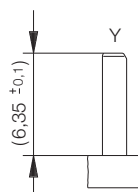

# ERmet ZD

## High Speed Differential Hard Metric Connector System

### Right Angle Male Connectors 3 Pair

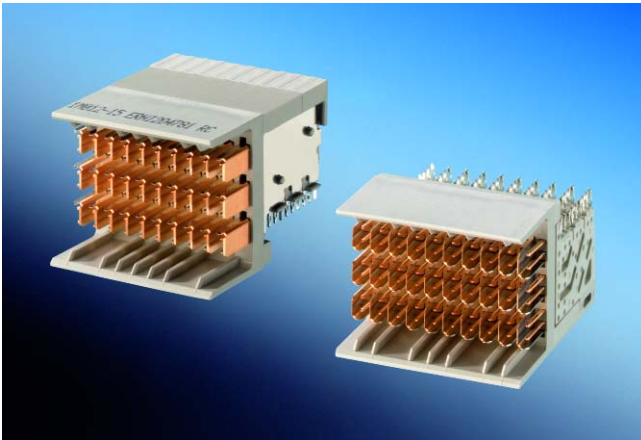

The ERmet ZD 3 pair right angle male connector provides in the 10 wafer version 30 contact pairs and is available with pressfit termination. The connector is designed for high speed differential applications and is an extension of the ERmet 2 mm HM product line.

### Dimensional drawings and board hole pattern

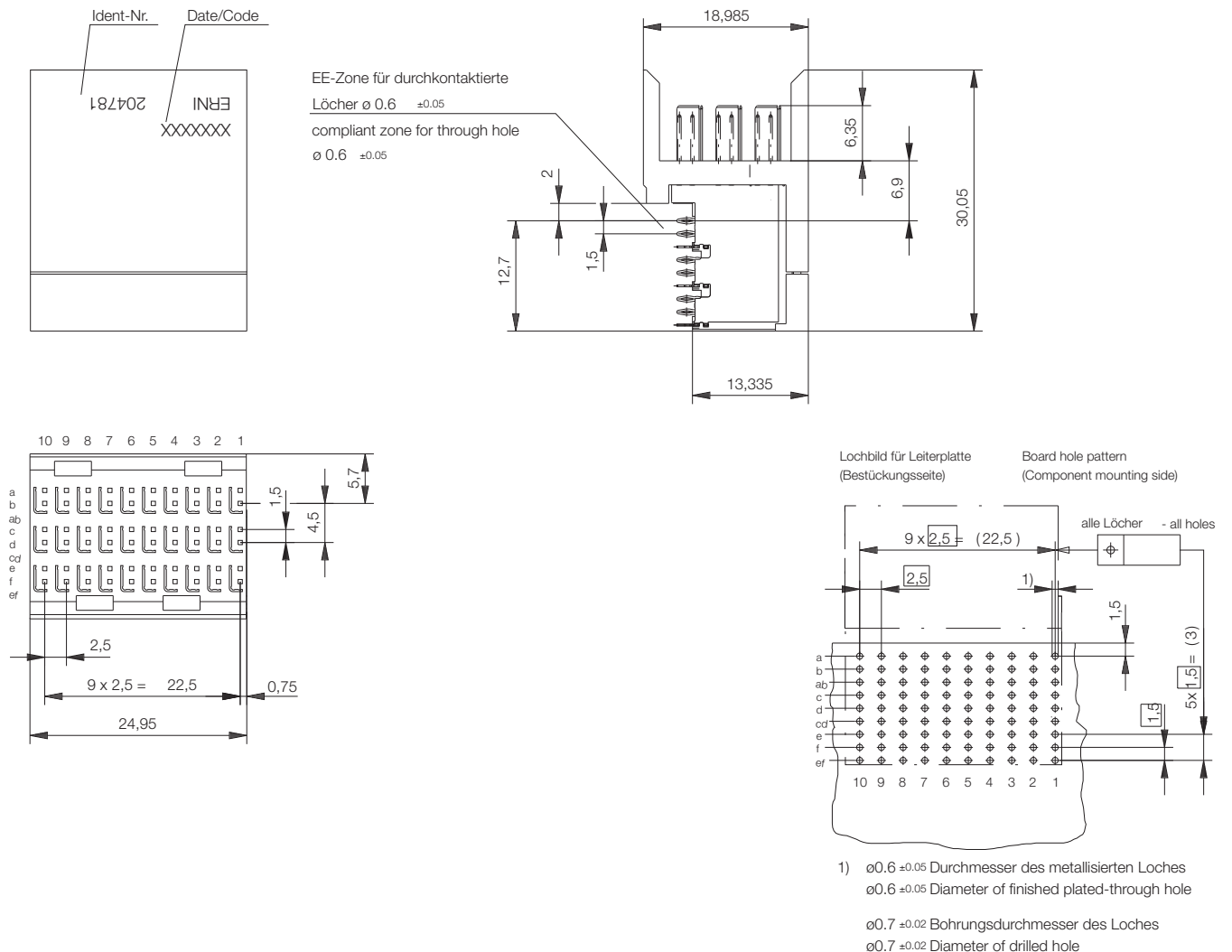

All dimensions in mm

**ERmet ZD**  
**High Speed Differential Hard Metric Connector System**  
**Right Angle Male Connectors 3 Pair**



**Ordering Information**

Configuration	Length	Pin Configuration	Termination	Termination Tail Length	Used For	No. of Pins	Part Number
3 Pair / 10 wafers	25 mm	30 pairs - 60 signals / 30 grounds	Pressfit	-	-	90	<b>204781</b>

**Signal Pins**

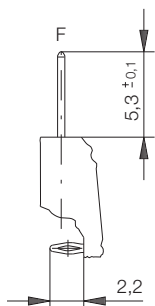

**Shielding Pins**

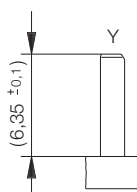



# ERmet ZD

## High Speed Differential Hard Metric Connector System

### Right Angle Male Connectors 2 Pair

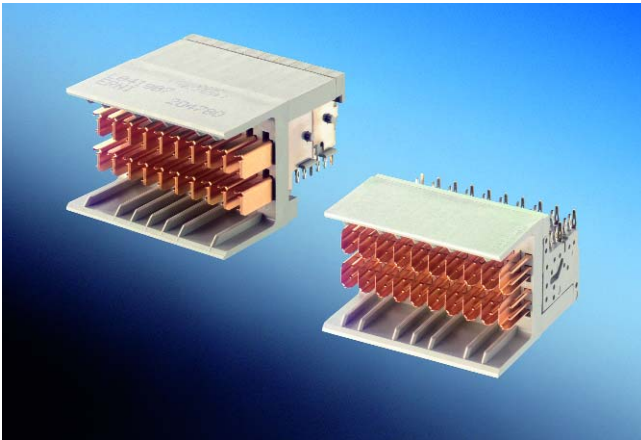

The ERmet ZD 2 pair right angle male connector provides in the 10 wafer version 20 contact pairs and is available with pressfit termination. The connector is designed for high speed differential applications and is an extension of the ERmet 2 mm HM product line.

### Dimensional Drawing

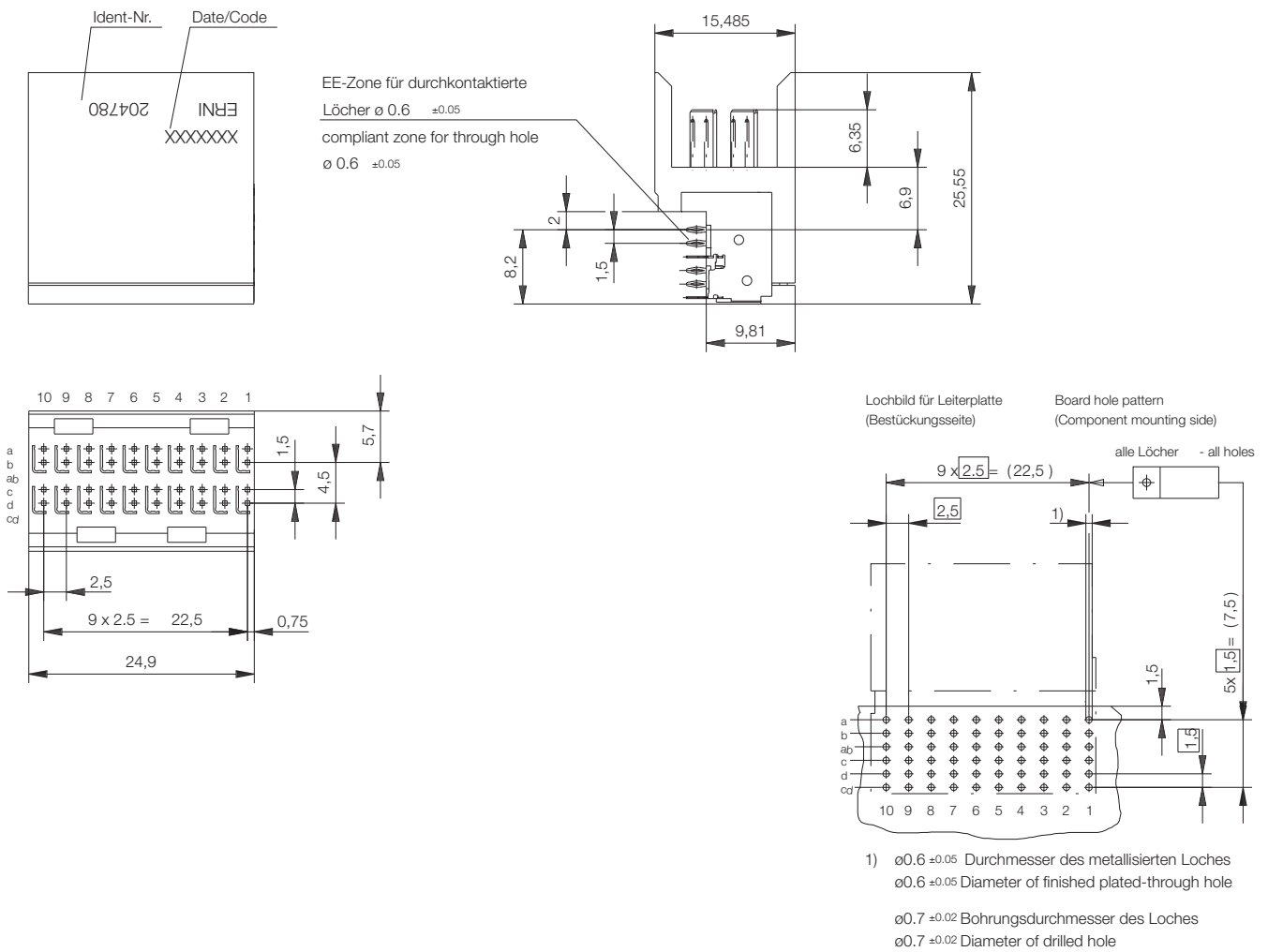

All dimensions in mm

**ERmet ZD**  
**High Speed Differential Hard Metric Connector System**  
**Right Angle Male Connectors 2 Pair**



**Ordering Information**

Configuration	Length	Pin Configuration	Termination	Termination Tail Length	Used For	No. of Pins	Part Number
2 pair / 10 wafers	25 mm	20 pairs - 40 signals / 20 grounds	Pressfit	-	-	60	<b>204780</b>

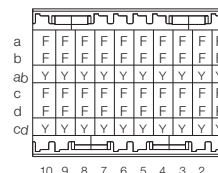
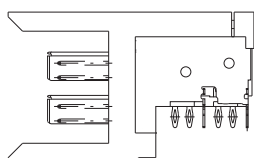

**Signal Pins**

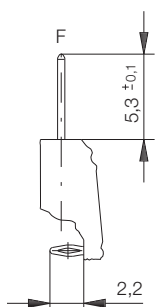

**Shielding Pins**

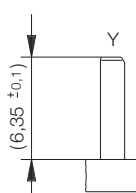

# ERmet ZD

## High Speed Differential Hard Metric Connector System

### Vertical Female Connectors 4 Pair

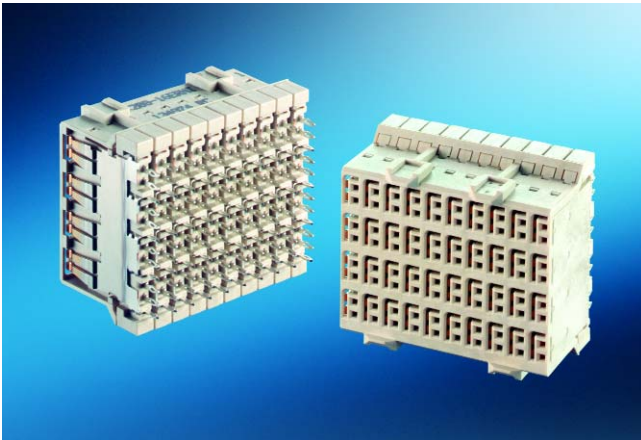

In addition to the four-pair connector modules specified for use in AdvancedTCA® Zone 2, the product line includes two-pair and three-pair signal modules and coplanar connectors. A mezzanine style connector is also available in a four-pair version (vertical female pressfit).

### Dimensional Drawing

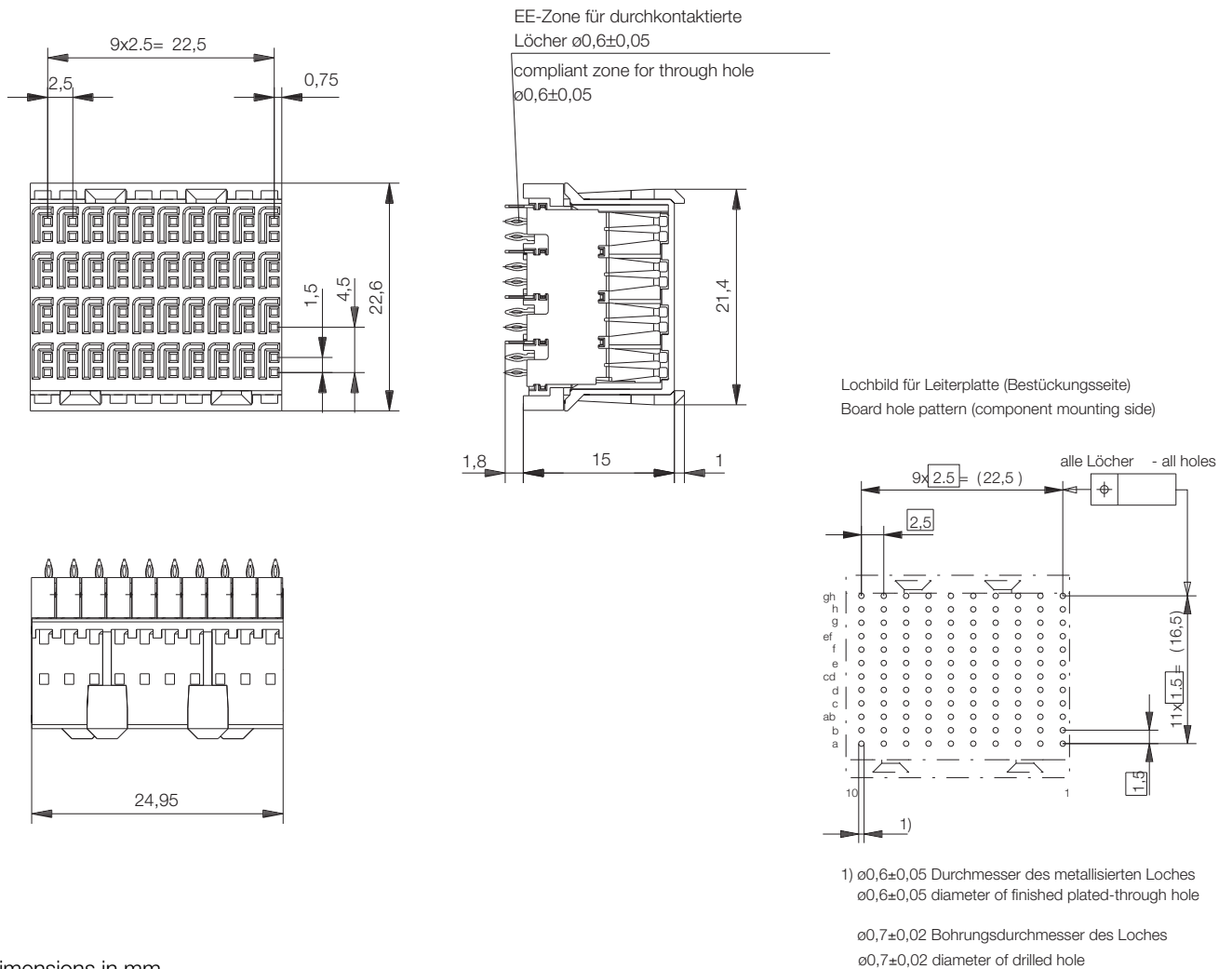

All dimensions in mm

**ERmet ZD**  
**High Speed Differential Hard Metric Connector System**  
**Vertical Female Connectors 4 Pair**

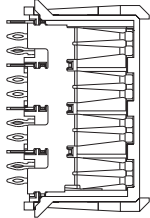
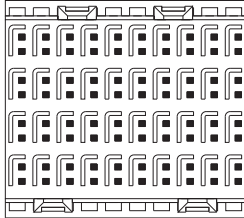
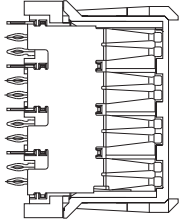
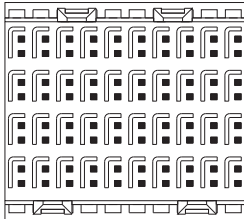

**Ordering Information**

Configuration	Length	Pin Configuration	Termination	Termination Tail Length	Connector Height *	No. of Pins	Part Number
							
4 Pair / 10 wafers	25 mm	40 pairs - 80 signals / 40 grounds	Pressfit	1.8 mm	12 mm	120	<b>134883</b>
							
4 Pair / 10 wafers	25 mm	40 pairs - 80 signals / 40 grounds	Pressfit	1.8 mm	15 mm	120	<b>134974</b>

\* Board-to-Board Distance:

Female Connector Height + Male Connector Height = Board-to-Board Distance

12 mm + 3 mm = 15 mm

15 mm + 3 mm = 18 mm

**ERmet ZD**  
**High Speed Differential Hard Metric Connector System**  
**Application Tooling, Equipment and Testing**



**Evaluation Kits**

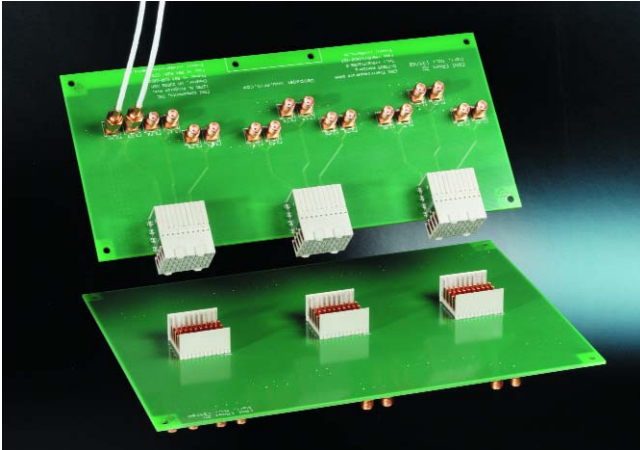

The two evaluation kits, singleline version and multiline version, are developed to measure the signal integrity behavior of the advanced differential pair connector system ERmet ZD. Each evaluation kit contains the test boards and a CD Rom with the description of the measurement set up and relevant technical information. The boards are designed in a manner that allows full de-embedding of the parasitic influence of the transmission lines and the SMA connectors on the board. This ensures properly measured values of the connector system itself without any negative influence of the test fixture. Measurements can be performed with a Time Domain Reflectometer in the Time domain or a Vector Network Analyzer in the frequency domain.

**Configuration**

The multiline version is specially designed to determine the multiline crosstalk between up to 10 signal pairs and to measure a connector directly at its pins.

**Part Number**

**163211**

The singleline version can be used to determine differential impedance of single signal pairs, crosstalk between two signal pairs, transmission and reflection behavior of single pairs and propagation delay of single pairs.

**163210**

**Simulation Models**

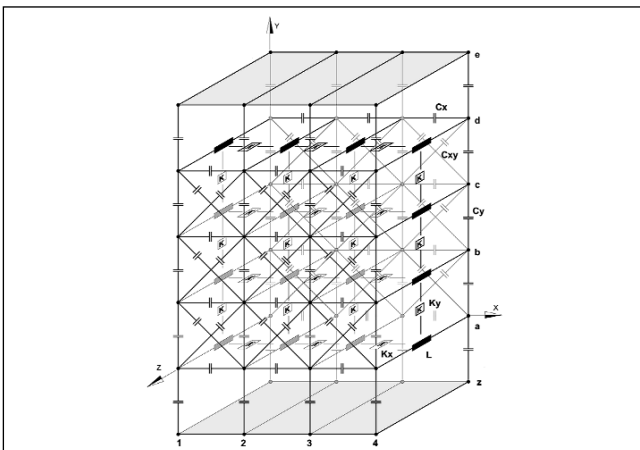

The ERNI ERmet ZD simulation models are provided in two different formats:

1. Spice compatible models based on L, R, C and K elements in accordance to UC Berkeley Spice3f5 standard.
2. S-parameter data in Touchstone file format

For each format, two different types of simulation models are given:

1. A set of very compact models, which represents only one signal pair (e.g. a-b) of the connector. These models should be used, if only the reflection behavior and the impedance matching of the connector should be analyzed. They do not slow down a simulator significantly.

This model is available on the ERNI web page.

2. A set of models which represent 3 wafers of the connector with each wafer containing 2, 3 or 4 signal pairs. This model family fully represents the connector behavior including:

- impedance matching
- crosstalk behavior
- ground bounce

This model is only available when the customer has signed an NDA.

The usage of each model is explained in the header part of the appropriate library file.

**Configuration**

CD with Simulation Models for the ERmet ZD Connector System

**Part Number**

**144470**

## ERmet ZD

### High Speed Differential Hard Metric Connector System

#### Application Tooling, Equipment and Testing



#### Modular Pressfit Tools



ERmet ZD connectors can be end to end mounted in modular layout. To be able to pressfit the selected connector layout for your application in a rationalized way, we have designed the necessary pressfit tools to be modular too. This is true of the tools both for male connectors and for female connectors. The tool bases, also termed anvils, are fixed in a tool holder. Each connector module requires an appropriately sized tool module.

#### Ordering Information

Connector Type	Wafer	Part Number Upper Tool	Part Number Lower Tool
Right Angle Female Connectors 4 Pair	10	220629	220630
Right Angle Female Connectors 3 Pair	10	220634	220635
Right Angle Female Connectors 2 Pair	10	220637	220638
Verticale Male Connectors 4 Pair	10	220627	220628
Verticale Male Connectors 3 Pair	10	220633	220640
Verticale Male Connectors 2 Pair	10	220636	220639
Right Angle Male Connectors 4 Pair	10	220880	220630
Right Angle Male Connectors 3 Pair	10	220879	220635
Right Angle Male Connectors 2 Pair	10	220895	220638
Verticale Female Connectors 4 Pair	10	220806	220628
Verticale Male 4 Pair Cable Header	10	220758	220628



# ERmet ZD

## High Speed Differential Hard Metric Connector System

### Mating Conditions



#### Misalignment Parameters

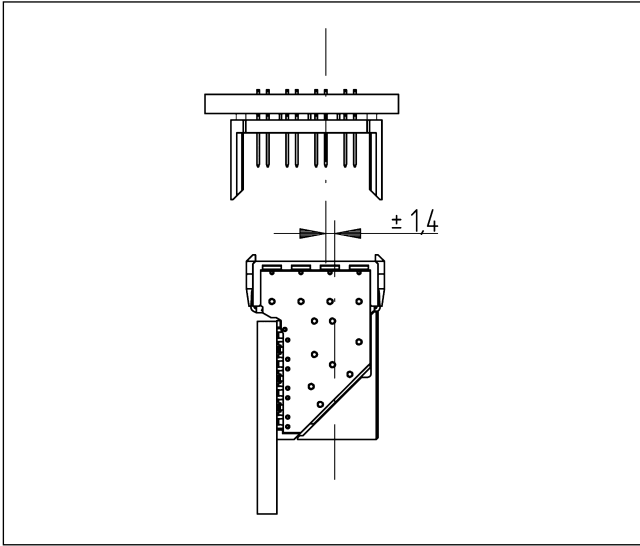

Transverse axis

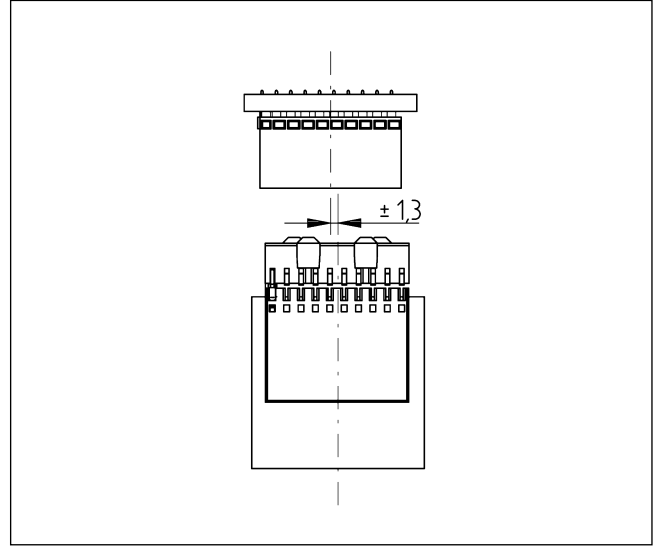

Longitudinal axis

#### Inclination Parameters

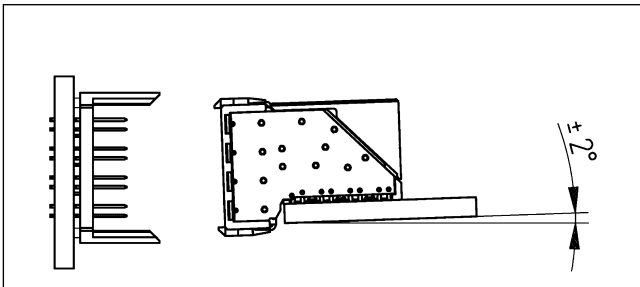

Transverse axis

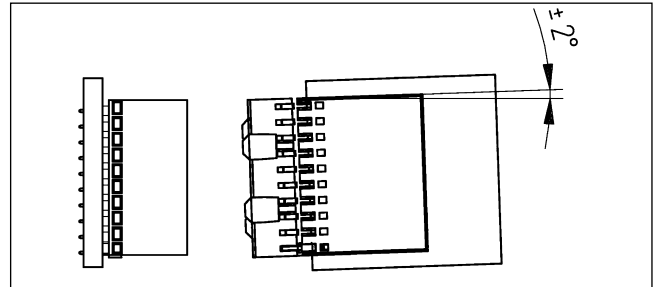

Longitudinal axis

# ERmet ZD High Speed Differential Hard Metric Connector System Recommended PCB Layout



## ERmet ZD Daughtercard and 2 mm HM Connectors

### 4 Pair

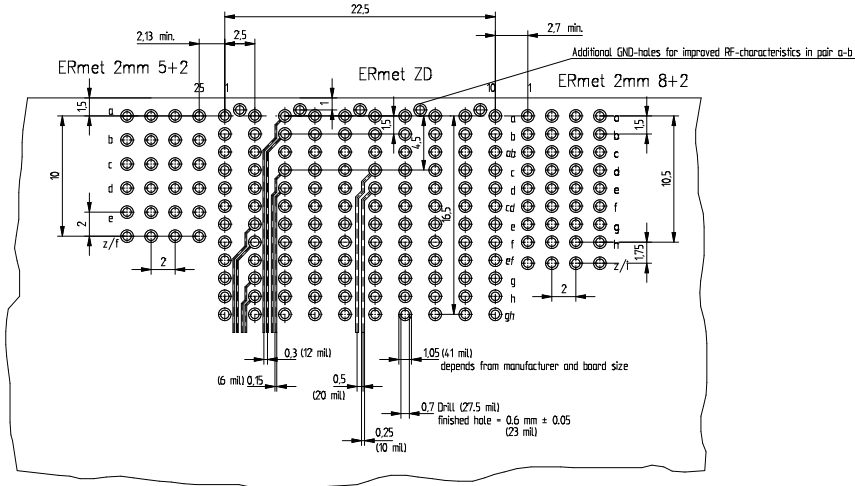

### 3 Pair

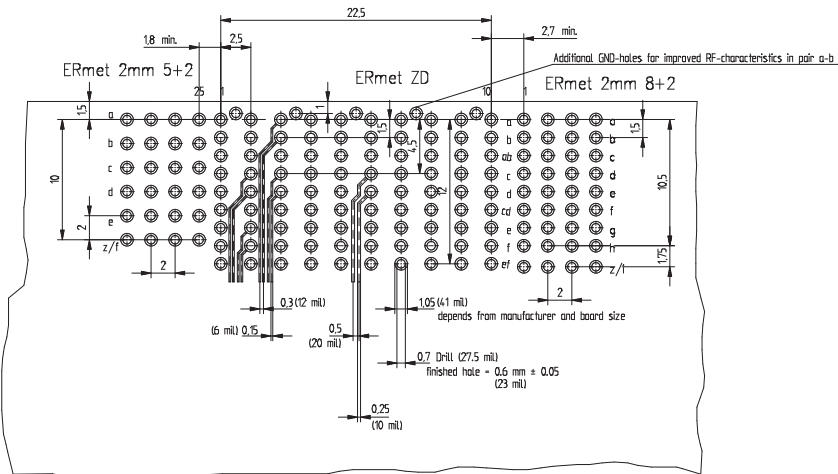

### 2 Pair

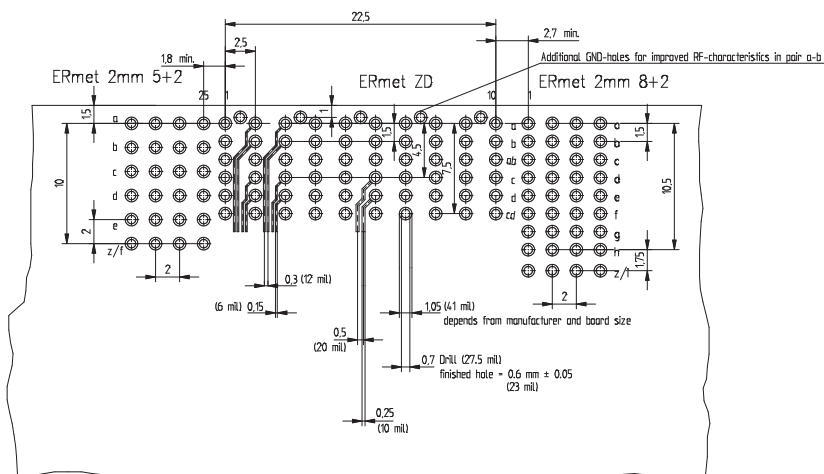



# ERmet ZD High Speed Differential Hard Metric Connector System Recommended PCB Layout



## Midplane Layout

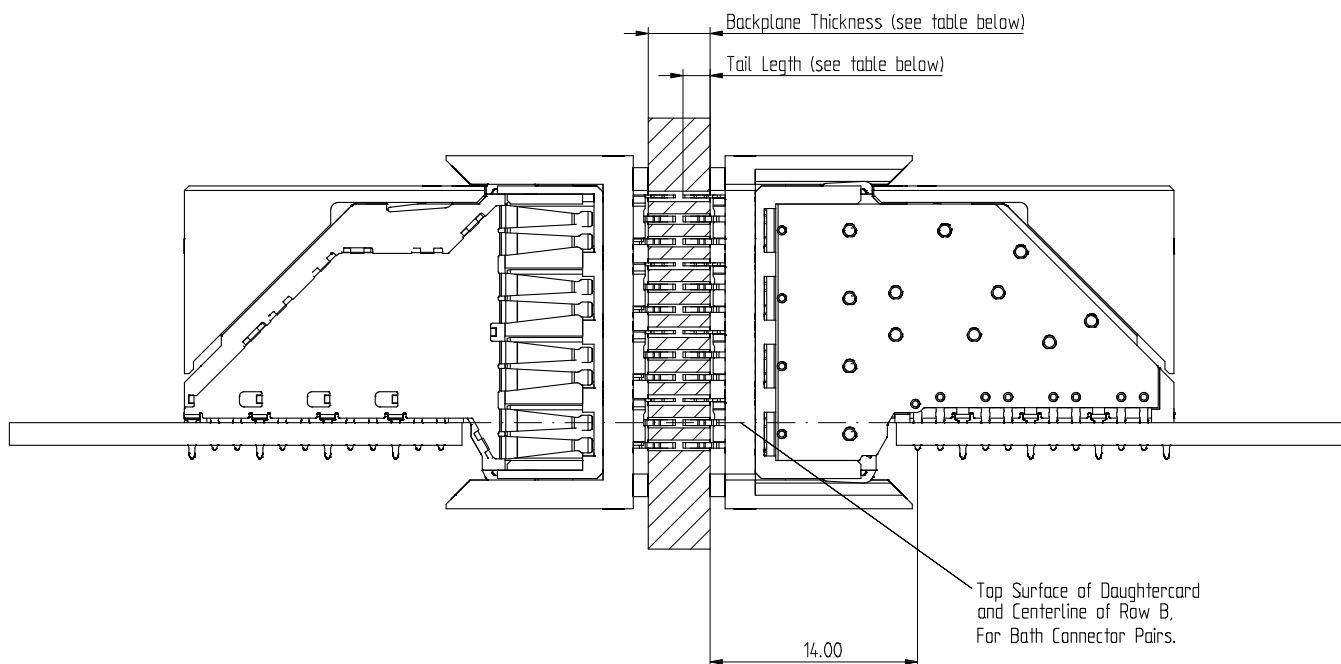

Tail Length	Min. Recommended Backplane Thickness
1.80	4.00
2.50	5.40

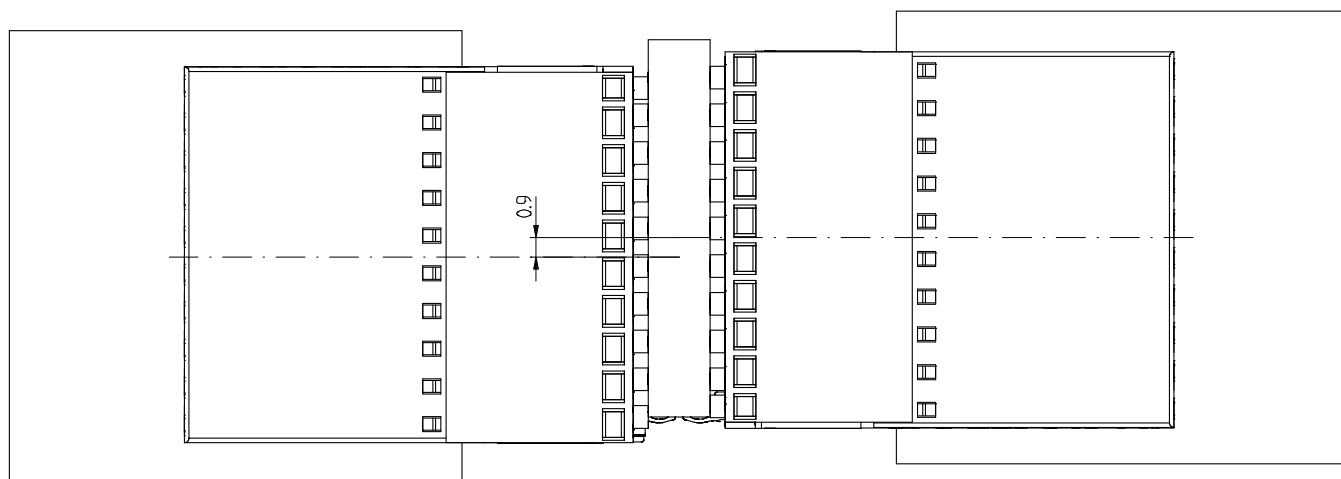

# ERmet ZD High Speed Differential Hard Metric Connector System Recommended PCB Layout



## ERmet ZD Connector Coplanar

ERmet ZD Right Angle Male

ERmet ZD Right Angle Female

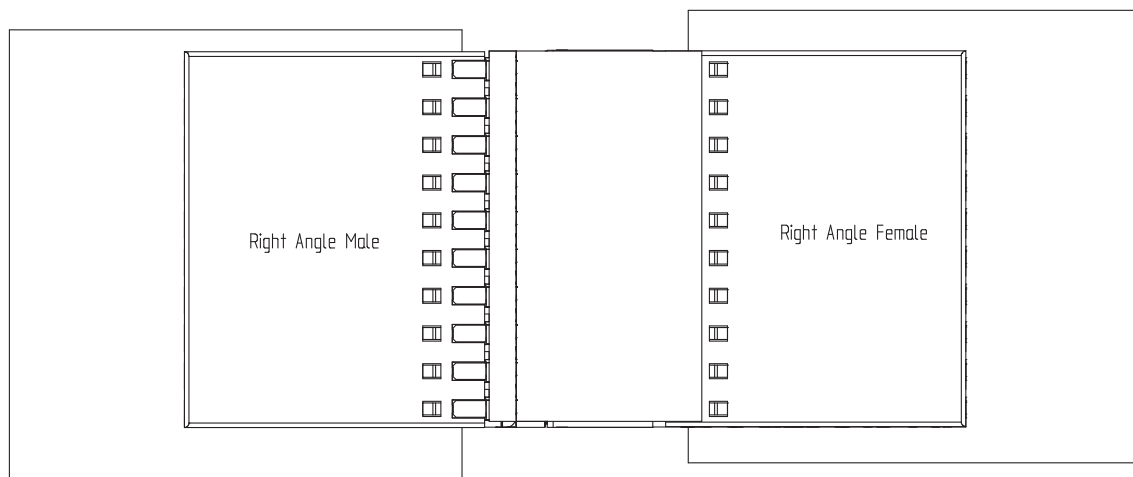
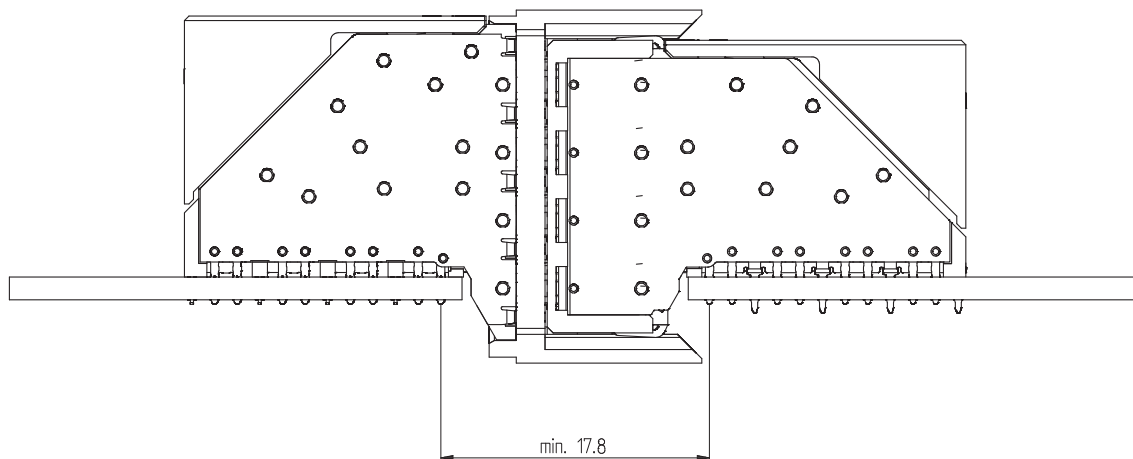

# ERmet ZD High Speed Differential Hard Metric Connector System Stubbing Effect

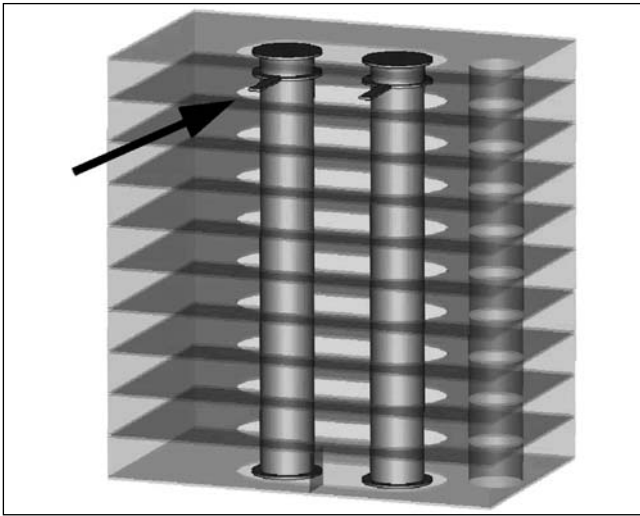

Top of pcb (connecor side)

Traces near the connector layer result in via stubs which cause undesirable reflections.

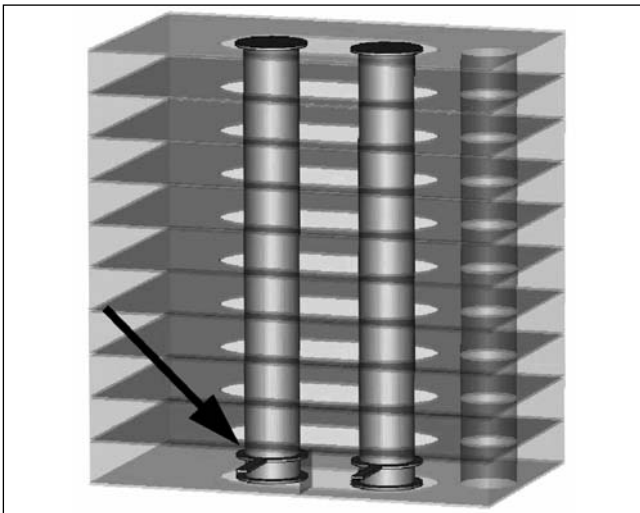

Top of pcb (connector side)

Traces near the bottom layer improve the reflection behaviour.

**ERmet ZD**  
**High Speed Differential Hard Metric Connector System**  
**Antipad Size**

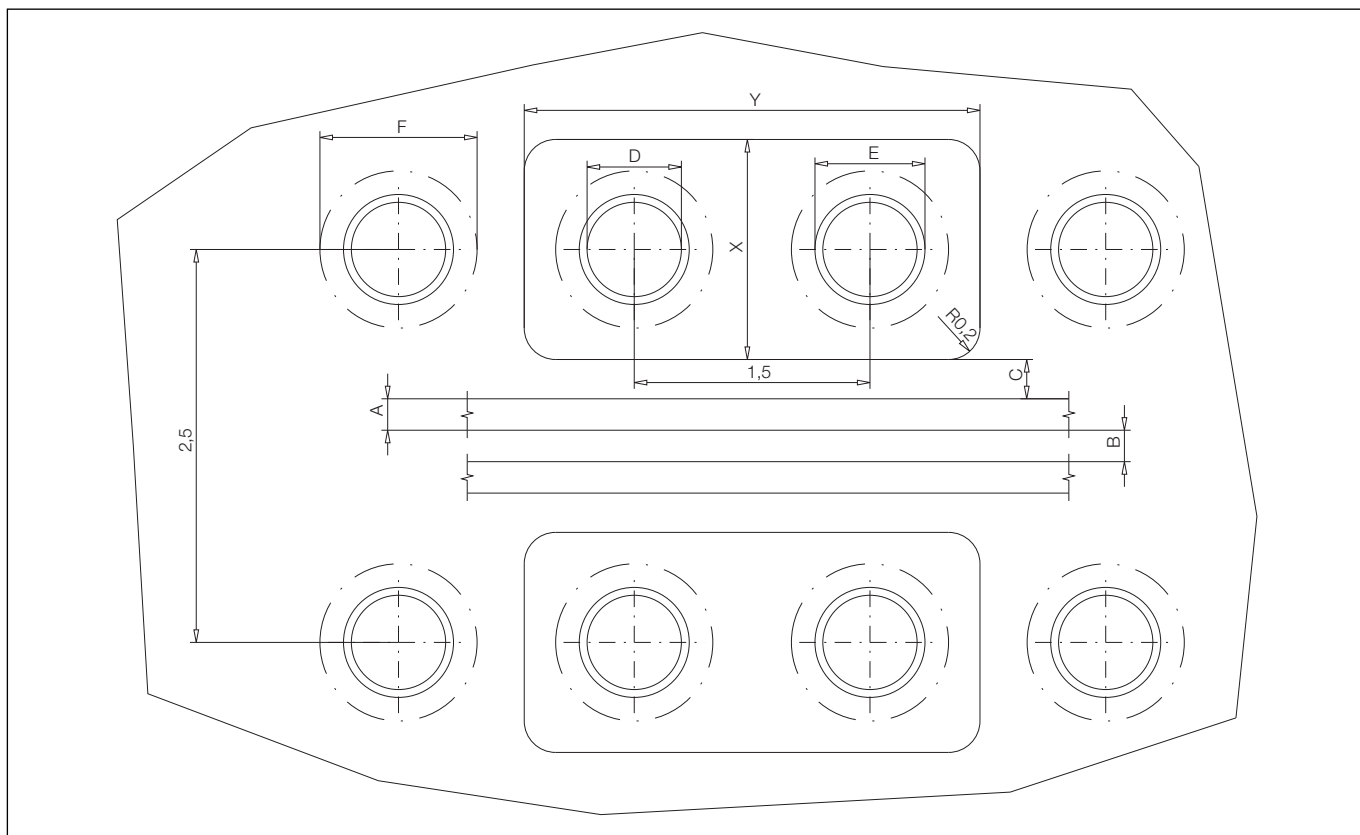

**Drawing shows one differential track pair**

A = trackwidth  
 E = drill hole

B = space between tracks  
 F = pad diameter

C = space  
 X x Y = antipad size

D = plated hole

**The table below shows two examples for the antipad size**

No. of Track-Pairs	Pad-Diameter	Antipad Size X x Y	Space C	Trackwidth A.	Space between Tracks B
2	1.0mm	1.3 x 2.8mm	0.075mm*	0.15mm	0.15mm
1	1.0mm	1.3 x 2.9mm	0.1mm*	0.25mm	0.4mm

(\*) overlapping is necessary because of impedance control

**Note:**

To improve the high speed characteristics, remove all pads on unconnected layers!  
 Smaller padsizes also improves the electrical characteristics!  
 Antipad size as large as possible also improves the electrical characteristics!

# ERmet ZD High Speed Differential Hard Metric Connector System Additional Mechanical Features



## Termination Details

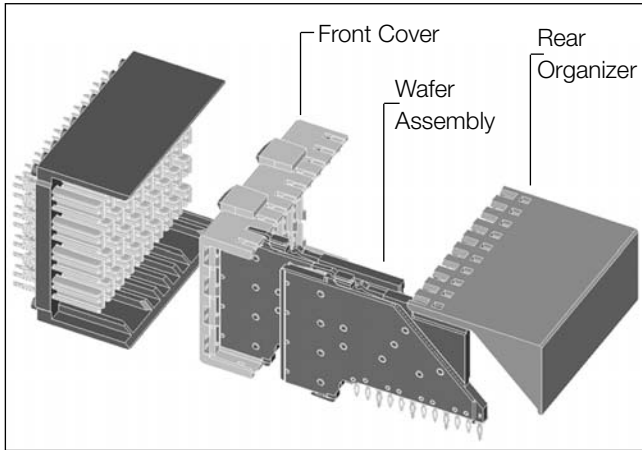

ERmetZD backplane and daughter card modules are available in pressfit versions. The parts are fully intermateable and differ physically only in their printed circuit board layout requirements.

The pressfit versions utilize the same eye of the needle compliant pin design for both the signal and ground terminals. The finished plated through-hole requirements are 0.55mm to 0.65mm which is the same hole specified by IEC 61076-4-101 for all 2mm HM connectors.

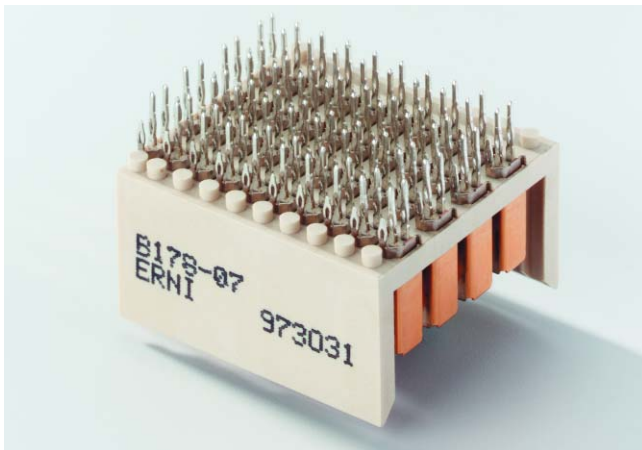

All ERmetZD modules are designed with an air gap between the connector and the board to facilitate convection reflow soldering methods. Additionally, the housing materials are comprised of a thermally stable polymer made to withstand higher temperatures.

## Alignment Modules



Optional Alignment Module

The solid alignment modules secure correct mating of large size daughter cards. To prevent damage to a system resulting from incorrect insertion of cards with different logic, coding keys can be snapped into the optional alignment modules. These are the same color coded keys defined within the IEC 61076-4-101 standard. The IEC standard defines a unique configuration and color for more than 70 different coding keys.



# ERmet ZD High Speed Differential Hard Metric Connector System Additional Mechanical Features



## Basic Grid Design

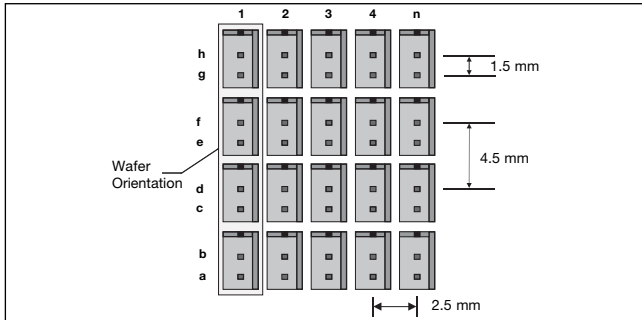

The design of today's high speed differential connectors is limited primarily by the electrical characteristics of the termination via geometry. The ERmetZD utilizes an optimum grid design which significantly reduces noise within the pattern and allows generous clearance for easier routing.

## Trace Density

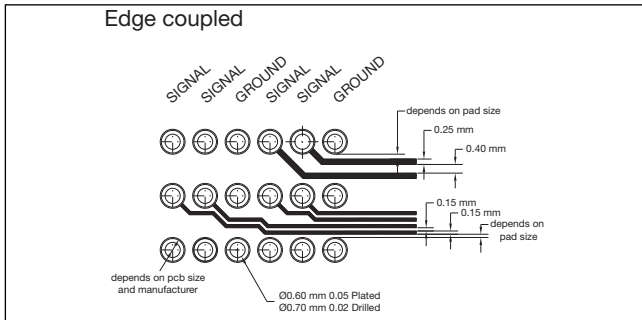

The grid pattern allows wide traces for long runs without ever having to separate two differential pairs to negotiate via holes, as shown in the proposed layouts.

## Plated Through-Holes for Pressfit Terminals

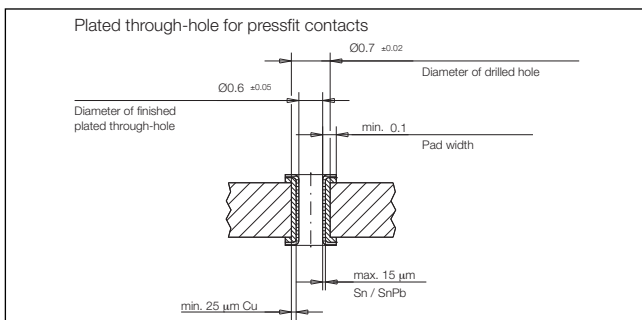

All ERmetZD, ERmet 5+2, ERmet 8+2 and ERmet Power Module pressfit terminals share plated through-hole requirements. These pressfit terminals have been used successfully with reflowed tin-lead, plated tin-lead, immersion tin, organic coatings over bare copper and immersion gold hole plating regimes. The hole recommendations and press in force information shown in this catalog are for reflowed tin-lead and plated tin-lead. Additional test data for other hole plating regimes are available through customer service.

## Short Termination Pins of the Shield at the Male Pressfit Connectors.

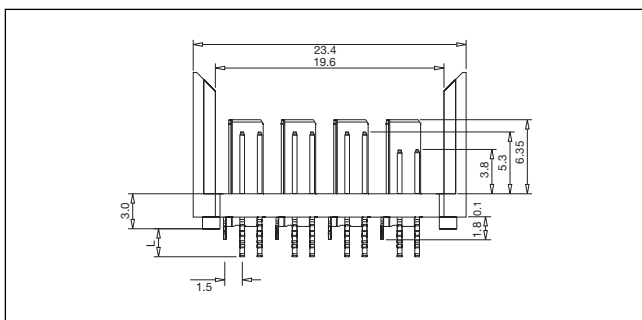

Note that the pressfit shield terminals are shorter than the pressfit terminals of the signal pins. This allows the standard shields to be used with signal terminals that are either 3.7mm or 1.8mm long.

# ERmetZD High Speed Differential Hard Metric Connector System Daughter Card Layout



The ERmetZD connectors are available in module lengths suitable for use in the J3/P3, J5/P5 positions on 6U-160mm daughter cards designed in accordance with VITA 30.1 for CompactPCI® and other Eurocard applications. The use of ERmetZD high speed differential connectors may also prove to be popular for new high speed, differential I/O requirements. The drawin below is a preliminary recommendation from ERNI and has not yet been considered by any standards group.

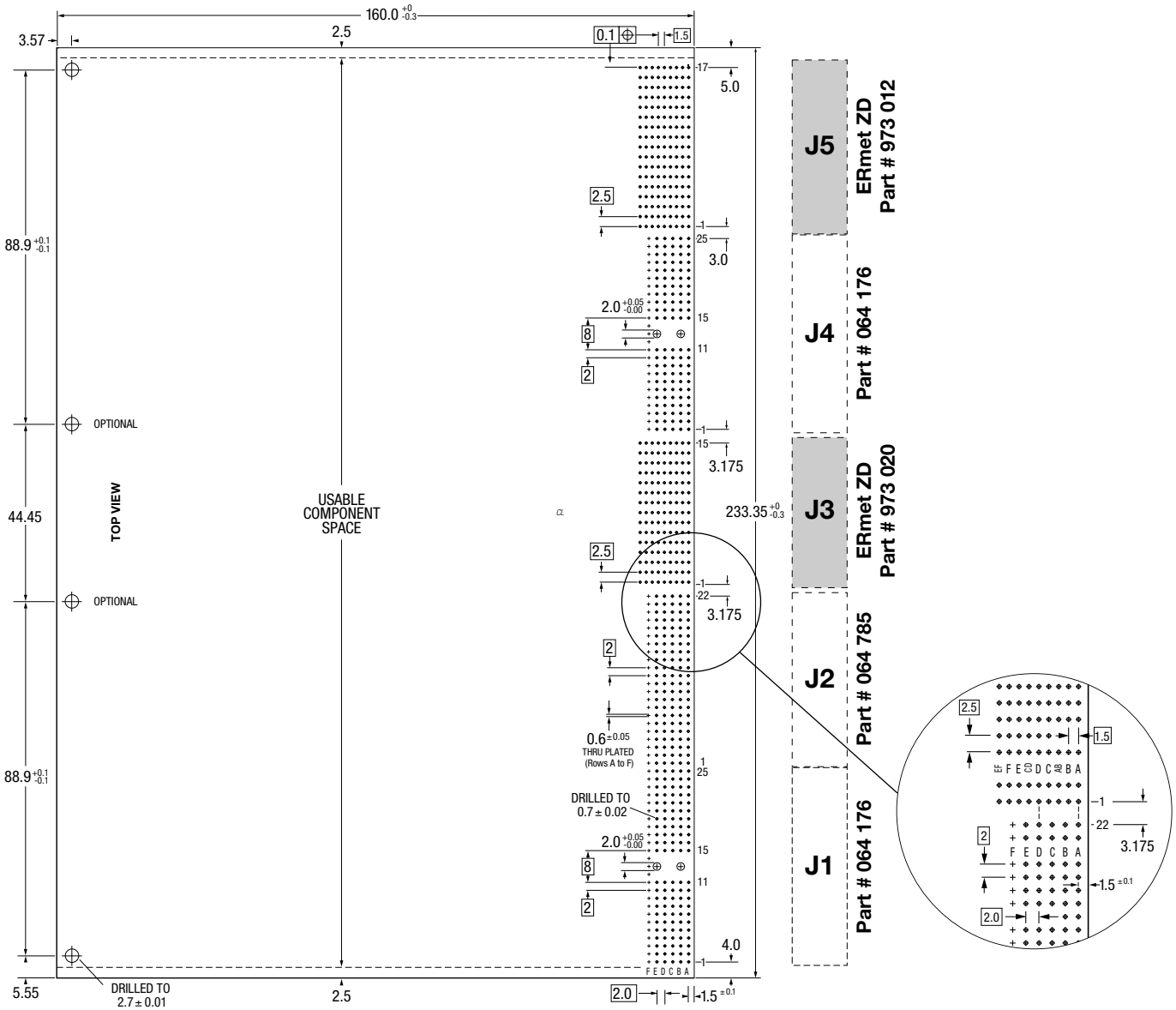

The 6U-160mm layout shown above is a suggested layout showing how ERmetZD modules in J3 and J5 are to be positioned adjacent to standard 2mm Hm modules in positions J1, J2 and J4.

Note that the daughtercard is numbered in accordance with the CompactPCI® specification. The numbering on the connectors themselves is different and in accordance with the IEC 61076-4-101 standard.

**ERmet ZD**  
**High Speed Differential Hard Metric Connector System**  
**Part Number Index**



Part Number	Page
134883	26
134974	26
144470	27
163210	27
163211	27
204780	24
204781	22
220627	28
220628	28
220629	28
220630	28
220633	28
220634	28
220635	28
220635	28
220636	28
220637	28
220638	28
220639	28
220640	28
220758	28
220806	28
220879	28
220880	28
220895	28
223396	15
973019	16
973020	8
973023	13
973024	6
973027	15
973028	8
973031	12
973032	6
973046	10
973056	18
973061	12
973062	15
973063	18
973080	18
973096	12
973099	6
973101	20

北京 15601379173 (微信)

上海 18924626834 (微信)



Find your correct contact person  
on [erni.com/locations](https://www.erni.com/locations)

© ERNI International AG 2020 • Printed in Germany • A policy of continuous improvement is followed and the right to alter any published data without notice is reserved. ERNI®, ERNI WoR&D®, CONNECTED BY COMPETENCE®, MicroBridge®, MicroCon®, MicroStac®, MicroSpeed®, MiniBridge®, MaxiBridge®, iBridge Ultra®, ERmet®, ERmet ZD®, ERmet ZDplus®, ERmet ZD HD®, ERbic®, ZipCon® and INTERact® are trademarks (registered or applied for in various countries) of ERNI Production GmbH & Co. KG.

深圳 18926488741 (微信)

[shunto@126.com](mailto:shunto@126.com)