



DLC - Compact High Resolution Pressure Sensors Series

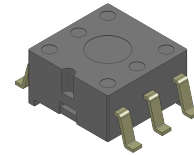
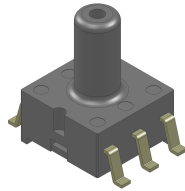
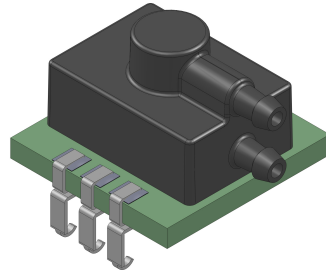
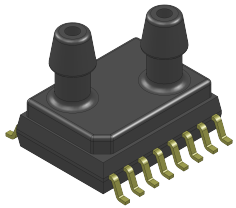

Table of Contents

| | |
|---|-------|
| Features & Applications | 2 |
| Pressure Sensor Maximum Ratings | 2 |
| Environmental Specifications | 2 |
| Equivalent Circuit | 2 |
| Standard Pressure Ranges | 3 |
| Performance Characteristics | 4 |
| Soldering Recommendations | 4 |
| I2C Electrical Parameters | 5 |
| Operation Overview | 6-7 |
| Digital Interface Command & Data Formats .. | 7-8 |
| I²C Interface | 8-10 |
| How to Order Guide | 11 |
| Standard Part Number Configurations | 11 |
| Product Identification Guide | 12 |
| Dimensional Package Drawings | |
| Differential SMT, SML and SOIC .. | 13-14 |
| Gage DIP and SMT | 15 |
| Absolute SMT | 16 |
| Packing Options | 16 |
| Pressure Tubing Recommendations | 17 |
| Suggested Pad Layouts | 17 |

Introduction

The DLC Series Compact High Resolution Sensor is based on All Sensors' CoBeam²™ Technology. This reduces package stress susceptibility, resulting in improved overall long term stability. This technology breakthrough advances the state of the art for piezoresistive pressure sensors beyond what has been achieved for low pressure sensing using silicon based strain technology. Design engineers will find exceptional space savings with optimal performance for various compact applications.

The low supply voltage allows for integration of the sensors into a wide range of process control and measurement systems, as well as direct connection to I2C serial communications channels. The DLC series offers 16 bit digital resolution. The digital interface options ease integration of the sensors into a wide range of process control and measurement systems, allowing direct connection to serial communications channels. For battery-powered systems, the sensors can enter very low-power modes between readings to minimize load on the power supply.

These calibrated and compensated sensors provide accurate, stable output over a wide temperature range. This series is intended for use with non-corrosive, non-ionic working fluids such as air and dry gases.



DLC — COMPACT HIGH-RESOLUTION PRESSURE SENSORS

Features

- Pressure Ranges from 1 inH2O to 150 psi
- High Resolution 16 bit Output
- Digital I2C Interface
- 1.8V to 3.6V Supply Voltage Range
- Compact Package Sizes As Small As 7mm x 7mm

Applications

- Medical Breathing
- Industrial Controls
- HVAC
- Environmental Controls
- Portable Equipment

| Pressure Sensor Maximum Ratings | | Environmental Specifications | |
|---------------------------------|----------|---|-----------------|
| Supply Voltage (Vs) | 3.63 Vdc | Temperature Ranges | |
| Common Mode Pressure | 10 psig | Compensated | -25°C to 85 °C |
| | | Operating | -40°C to 85 °C |
| | | Storage | -40°C to 125 °C |
| | | Humidity Limits (non condensing) | 0 to 95% RH |

Equivalent Circuit

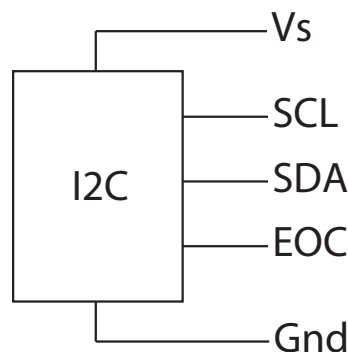

See package drawings for pinouts



Standard Pressure Ranges

Low Pressure Products

| Device | Operating Range ^A | Proof Pressure | Burst Pressure |
|----------|------------------------------|----------------|------------------------|
| DLC-L01D | ± 1 inH ₂ O | 248.84 Pa | 300 inH ₂ O |
| DLC-L02D | ± 2 inH ₂ O | 497.68 Pa | 300 inH ₂ O |
| DLC-L05D | ± 5 inH ₂ O | 1,244.20 Pa | 300 inH ₂ O |
| DLC-L10D | ± 10 inH ₂ O | 2,488.40 Pa | 300 inH ₂ O |
| DLC-L20D | ± 20 inH ₂ O | 4,976.80 Pa | 500 inH ₂ O |
| DLC-L30D | ± 30 inH ₂ O | 7,465.20 Pa | 500 inH ₂ O |
| DLC-L60D | ± 60 inH ₂ O | 14,930.4 Pa | 800 inH ₂ O |
| DLC-L01G | 0 to 1 inH ₂ O | 248.84 Pa | 300 inH ₂ O |
| DLC-L02G | 0 to 2 inH ₂ O | 497.68 Pa | 300 inH ₂ O |
| DLC-L05G | 0 to 5 inH ₂ O | 1,244.20 Pa | 300 inH ₂ O |
| DLC-L10G | 0 to 10 inH ₂ O | 2,488.40 Pa | 300 inH ₂ O |
| DLC-L20G | 0 to 20 inH ₂ O | 4,976.80 Pa | 500 inH ₂ O |
| DLC-L30G | 0 to 30 inH ₂ O | 7,465.20 Pa | 500 inH ₂ O |
| DLC-L60G | 0 to 60 inH ₂ O | 14,930.4 Pa | 800 inH ₂ O |

High Pressure Products

| Device | Operating Range ^A | Proof Pressure | Burst Pressure |
|----------|------------------------------|----------------|----------------|
| DLC-005D | ± 5 psi | 34.47 kPa | 15 psi |
| DLC-015D | ± 15 psi | 103.42 kPa | 45 psi |
| DLC-030D | ± 30 psi | 206.84 kPa | 90 psi |
| DLC-100D | ± 100 psi | 689.48 kPa | 225 psi |
| DLC-150D | ± 150 psi | 1,034.20 kPa | 225 psi |
| DLC-005G | 0 to 5 psi | 34.47 kPa | 15 psi |
| DLC-015G | 0 to 15 psi | 103.42 kPa | 45 psi |
| DLC-030G | 0 to 30 psi | 206.84 kPa | 90 psi |
| DLC-100G | 0 to 100 psi | 689.48 kPa | 225 psi |
| DLC-150G | 0 to 150 psi | 1,034.20 kPa | 225 psi |
| DLC-015A | 0 to 15 psia | 1.03 barA | 45 psi |
| DLC-030A | 0 to 30 psia | 2.06 barA | 90 psi |
| DLC-100A | 0 to 100 psia | 6.89 barA | 225 psi |
| DLC-150A | 0 to 150 psia | 10.34 barA | 225 psi |

Note A: Operating range in Pa is expressed as an approximate value.

Performance Characteristics for DLC Series

ALL PARAMETERS ARE MEASURED AT 3.3V \pm 5% EXCITATION AND 25C UNLESS OTHERWISE SPECIFIED (NOTE 6). PRESSURE MEASUREMENTS ARE WITH POSITIVE PRESSURE APPLIED TO PORT B.

| Parameter | Minimum | Typical | Maximum | Units | Specification Notes |
|---|---------|--------------------|-------------------|--------------|---------------------|
| Output Span (FSS) | | | | | 1 |
| LxxD (All Packages) | - | $\pm 0.4 * 2^{24}$ | - | Dec Counts | |
| LxxG (U2 Package) | - | $0.4 * 2^{24}$ | - | Dec Counts | |
| LxxG (All Other Packages) | - | $0.8 * 2^{24}$ | - | Dec Counts | |
| 0xxD (All Packages) | - | $\pm 0.4 * 2^{24}$ | - | Dec Counts | |
| 0xxG (All Packages) | - | $0.8 * 2^{24}$ | - | Dec Counts | |
| 0xxA (U5 Package) | - | $0.8 * 2^{24}$ | - | Dec Counts | |
| Offset Output @ Zero Diff. Pressure ($O_{s_{dig}}$) | | | | | - |
| LxxD (All Packages) | - | $0.5 * 2^{24}$ | - | Dec Counts | |
| LxxG (U2 Package) | - | $0.5 * 2^{24}$ | - | Dec Counts | |
| LxxG (All Other Packages) | - | $0.1 * 2^{24}$ | - | Dec Counts | |
| 0xxD (All Packages) | - | $0.5 * 2^{24}$ | - | Dec Counts | |
| 0xxG (All Packages) | - | $0.1 * 2^{24}$ | - | Dec Counts | |
| 0xxA (U5 Package) | - | $0.1 * 2^{24}$ | - | Dec Counts | |
| Total Error Band | | | | | 2 |
| L01G | - | - | ± 3.00 | %FSS | |
| L01D, L02G | - | - | ± 2.00 | %FSS | |
| L02D, L05G, L05D, L10G, L10D, L20G | - | - | ± 1.25 | %FSS | |
| L20D, L30G, L30D, L60G, L60D | - | - | ± 1.00 | %FSS | |
| All Higher Pressure | - | - | ± 1.00 | %FSS | |
| Pressure Digital Resolution - No Missing Codes | | | | | - |
| 16-bit Option | 15.3 | 15.5 | - | bit | |
| Temperature Output | | | | | - |
| Resolution | - | 16 | - | bit | |
| Overall Accuracy | - | 2 | - | $^{\circ}$ C | |
| Supply Current Requirement | | | | | 3, 4, 5 |
| During Active State (ICC_{Active}) | - | 2.0 | 2.5 | mA | |
| During Idle State (ICC_{Idle}) | - | 100 | 250 | nA | |
| Power On Delay | | | | | 3 |
| Data Update time (t_{DU}) | | | (see table below) | ms | 3, 4 |

| Calibrated Resolution | Measurement Command | | | | | | | | | | Units |
|-----------------------|---------------------|-----|----------|-----|----------|------|----------|------|-----------|------|-------|
| | Single | | Average2 | | Average4 | | Average8 | | Average16 | | |
| | Typ | Max | Typ | Max | Typ | Max | Typ | Max | Typ | Max | |
| 16 bit | 3.70 | 4.1 | 7.20 | 8.0 | 14.20 | 15.7 | 28.20 | 31.1 | 56.20 | 61.9 | ms |

Soldering Recommendations

- 1) Solder parts as a second operation only.
- 2) Post reflow, wait for 48 hrs before performing any calibration operations.
- 3) Perform spot cleaning as necessary only by hand. **DO NOT** wash or submerge device in cleaning liquid.



I2C Electrical Parameters for DLC Series

| Parameter | Symbol | Min | Typ | Max | Units | Notes |
|--|---------------------|------|-----|------|---------|-------|
| Input High Level | - | 80.0 | - | 100 | % of Vs | 5 |
| Input Low Level | - | 0 | - | 20.0 | % of Vs | 5 |
| Output Low Level | - | - | - | 10.0 | % of Vs | 5 |
| I2C Pull-up Resistor | - | 1000 | - | - | Ω | 5 |
| I2C Load Capacitance on SDA, @ 400 kHz | C _{SDA} | - | - | 200 | pF | 5 |
| I2C Input Capacitance (each pin) | C _{I2C_IN} | - | - | 10.0 | pF | 5 |
| I2C Address | | | 41 | | decimal | |

Pressure Output Transfer Function

$$Pressure(inH_2O) = 1.25 \times \left(\frac{Pout_{dig} - OS_{dig}}{2^{24}} \right) \times FSS(inH_2O)$$

Where:

$Pout_{dig}$ Is the sensor 24-bit digital output.

OS_{dig} Is the specified digital offset output.
(see Performance Characteristics Table)

$FSS(inH_2O)$ The sensor Full Scale Span in inches H₂O
For Gage Operating Range sensors: Full Scale Pressure
For Differential Operating Range sensors: 2 x Full Scale Pressure.

Temperature Output Transfer Function

$$Temperature (^{\circ}C) = \left(\frac{Tout_{dig} * 150}{2^{24}} \right) - 40$$

Where:

$Tout_{dig}$ The sensor 24-bit digital temperature output.
(Note that only the upper 16 bits are significant)

Specification Notes

NOTE 1: THE SPAN IS THE ALGEBRAIC DIFFERENCE BETWEEN FULL SCALE DECIMAL COUNTS AND THE OFFSET DECIMAL COUNTS. THE FULL SCALE PRESSURE IS THE MAXIMUM POSITIVE CALIBRATED PRESSURE.

NOTE 2: TOTAL ERROR BAND CONSISTS OF OFFSET AND SPAN TEMPERATURE AND CALIBRATION ERRORS, LINEARITY AND PRESSURE HYSTERESIS ERRORS, OFFSET WARM-UP SHIFT AND OFFSET POSITION SENSITIVITY ERRORS.

NOTE 3: PARAMETER IS CHARACTERIZED AND NOT 100% TESTED.

NOTE 4: DATA UPDATE TIME IS EXCLUSIVE OF COMMUNICATIONS, FROM COMMAND RECEIVED TO END OF BUSY STATUS. THIS CAN BE OBSERVED AS EOC PIN LOW- STATE DURATION.

NOTE 5: AVERAGE CURRENT CAN BE ESTIMATED AS : $ICC_{idle} + ((t_{DU} / \text{READING INTERVAL}) * ICC_{ACTIVE})$. REFER TO FIGURE 2 FOR ACTIVE AND IDLE CONDITIONS OF THE SENSOR (THE ACTIVE STATE IS WHILE EOC PIN IS LOW).

NOTE 6: THE SENSOR IS CALIBRATED WITH A 3.3V SUPPLY HOWEVER, AN INTERNAL REGULATOR ALLOWS A SUPPLY VOLTAGE OF 1.8V TO 3.6V TO BE USED WITHOUT AFFECTING THE OVERALL SPECIFICATIONS. THIS ALLOWS DIRECT OPERATION FROM A BATTERY SUPPLY.

Note 7: CALIBRATED WITH CONTINUOUS READS.

Device Ordering Options

Output Resolution

Calibrated output resolution of 16 bits.

See the Data Update Time in the Performance Characteristics table.

Operation Overview

The DLC is a digital sensor with a signal path that includes a sensing element, a variable-bit analog to digital converter, a DSP and an IO block that supports an I2C interface (see Figure 1 below). The sensor also includes an internal temperature reference and associated control logic to support the configured operating mode. Since there is a single ADC, there is also a multiplexer at the front end of the ADC that selects the signal source for the ADC.

Figure 1 - DLC Essential Model

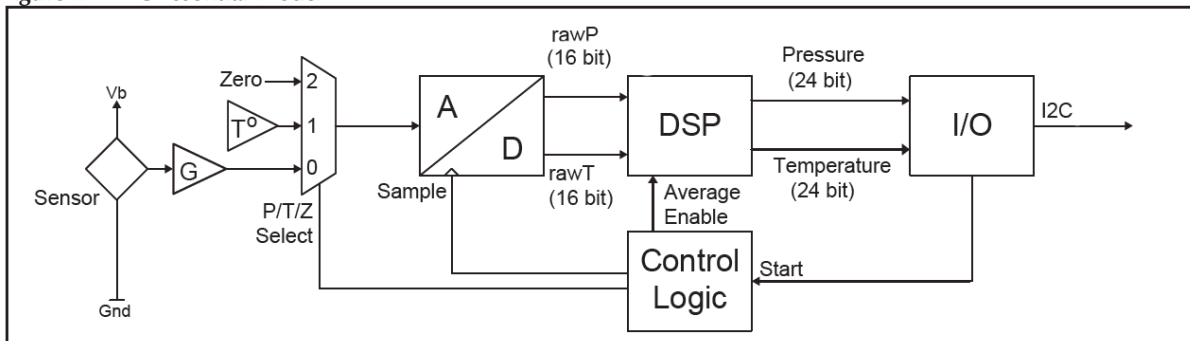

The ADC performs conversions on the raw sensor signal (P), the temperature reference (T) and a zero reference (Z) during the ADC measurement cycle.

The DSP receives the converted pressure and temperature information and applies a multi-order transfer function to compensate the pressure output. This transfer function includes compensation for span, offset, temperature effects on span, temperature effects on offset and second order temperature effects on both span and offset. There is also linearity compensation for gage devices and front to back linearity compensation for differential devices.

Sensor Commands: Five Measurement commands are supported, returning values of either a single pressure / temperature reading or an average of 2, 4, 8, or 16 readings. Each of these commands wakes the sensor from Idle state into Active state, and starts a measurement cycle. For the Start-Average commands, this cycle is repeated the appropriate number of times, while the Start-Single command performs a single iteration. When the DSP has completed calculations and the new values have been made available to the I/O block, the sensor returns to Idle state. The sensor remains in this low-power state until another Measurement command is received.

After completion of the measurement, the result may then be read using the Data Read command. The ADC and DSP remain in Idle state, and the I/O block returns the 7 bytes of status and measurement data. See Figure 2, following. At any time, the host may request current device status with the Status Read command. See Table 1 for a summary of all commands.

For optimum sensor performance, All Sensors recommends that Measurement commands be issued at a fixed interval by the host system. Irregular request intervals may increase overall noise on the output. Furthermore, if reading intervals are much slower than the Device Update Time, using the Averaging commands is suggested to reduce offset shift. This shift is constant with respect to time interval, and may be removed by the application. For longer fixed reading intervals, this shift may be removed by the factory on special request.



Operation Overview

Figure 2 - DLC Communication Model

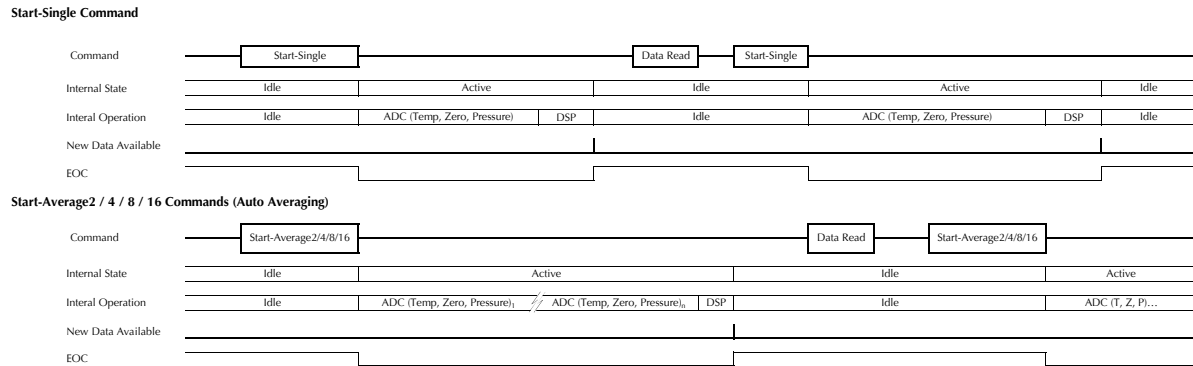

Digital Interface Command Formats

When requesting sensor status over I2C, the host simply performs a 1-byte read transfer.
When reading sensor data over I2C, the host simply performs a 7-byte read transfer.

See Table 1 below for Measurement Commands, Sensor Data read and Sensor Status read details.

Table 1 - DLC Sensor Command Set

| Measurement Commands | |
|----------------------|------|
| Description | I2C |
| Start-Single | 0xAA |
| Start-Average2 | 0xAC |
| Start-Average4 | 0xAD |
| Start-Average8 | 0xAE |
| Start-Average16 | 0xAF |

| Read Sensor Data | |
|------------------|-----------------------------|
| I2C | Read of 7 bytes from device |

| Read Sensor Status | |
|--------------------|-----------------------------|
| I2C | Read of 1 byte from device. |

Digital Interface Data Format

For either type of digital interface, the format of data returned from the sensor is the same. The first byte consists of the Status Byte followed by a 24-bit unsigned pressure value and a 24-bit unsigned temperature value. Unused bits beyond the calibrated bit width are undefined, and may have any value. See the Pressure Output Transfer Function and Temperature Output Transfer Function definitions on page 3 for converting to pressure and temperature. Refer to Table 2 for the overall data format of the sensor. Table 3 shows the Status Byte definition. Note that a completed reading without error will return status 0x40.

Table 2 - Output Data Format

| S[7:0] | P[23:16] | P[15:8] | P[7:0] | T[23:16] | T[15:8] | T[7:0] |
|-------------|--------------|-----------------|--------------|-----------------|--------------------|-----------------|
| Status Byte | Pressure MSB | Pressure Byte 1 | Pressure LSB | Temperature MSB | Temperature Byte 1 | Temperature LSB |

Table 3- Status Byte Definition

| Bit | Description |
|-------------|--|
| Bit 7 [MSB] | [Always = 0] |
| 6 | Power : [1 = Power On] |
| 5 | Busy: [1 = Processing Command, 0 = Ready] |
| 4:3 | Mode: [00 = Normal Operation] |
| 2 | Memory Error [1 = EEPROM Checksum Fail] |
| 1 | Sensor Configuration [always = 0] |
| Bit 0 [LSB] | ALU Error [1 = Error] |

I2C Interface

I2C Command Sequence

The part enters Idle state after power-up, and waits for a command from the bus master. Any of the five Measurement commands may be sent, as shown in Table 1. Following receipt of one of these commands, the EOC pin is set to Low level, and the sensor Busy bit is set in the Status Byte. After completion of measurement and calculation in the Active state, compensated data is written to the output registers, the EOC pin is set high, and the processing core goes back to Idle state. The host processor can then perform the Data Read operation, which for I2C is simply a 7-byte Device Read.

If the EOC pin is not monitored, the host can poll the Status Byte by repeating the Status Read command, which for I2C is a one-byte Device Read. When the Busy bit in the Status byte is zero, this indicates that valid data is ready, and a full Data Read of all 7 bytes may be performed.



I2C Interface (Cont'd)

I2C Bus Communications Overview

The I2C interface uses a set of signal sequences for communication. The following is a description of the supported sequences and their associated mnemonics. Refer to Figure 3 for the associated usage of the following signal sequences.

Bus not Busy (I): During idle periods both data line (SDA) and clock line (SCL) remain HIGH.

START condition (ST): A HIGH to LOW transition of SDA line while the clock (SCL) is HIGH is interpreted as START condition. START conditions are always set by the master. Each initial request for a pressure value has to begin with a START condition.

Slave address (An): The I²C-bus requires a unique address for each device. The DLC sensor has a preconfigured slave address (see specification table on Page 3). After setting a START condition the master sends the address byte containing the 7 bit sensor address followed by a data direction bit (R/W). A "0" indicates a transmission from master to slave (WRITE), a "1" indicates a device-to-master request (READ).

Acknowledge (A or N): Data is transferred in units of 8 bits (1 byte) at a time, MSB first. Each data-receiving device, whether master or slave, is required to pull the data line LOW to acknowledge receipt of the data. The Master must generate an extra clock pulse for this purpose. If the receiver does not pull the data line down, a NACK condition exists, and the slave transmitter becomes inactive. The master determines whether to send the last command again or to set the STOP condition, ending the transfer.

DATA valid (Dn): State of data line represents valid data when, after a START condition, data line is stable for duration of HIGH period of clock signal. Data on line must be changed during LOW period of clock signal. There is one clock pulse per data bit.

STOP condition (P): LOW to HIGH transition of the SDA line while clock (SCL) is HIGH indicates a STOP condition. STOP conditions are always generated by the master.

Figure 3 - I2C Communication Diagram

1. Measurement Commands: Start-Single (to start reading of single sample):

- Start-Single** C7...C0: 0xAA
- Start-Average2** C7...C0: 0xAC
- Start-Average4** C7...C0: 0xAD
- Start-Average8** C7...C0: 0xAE
- Start-Average16** C7...C0: 0xAF

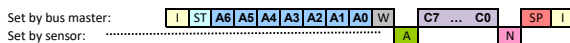

2. Status Read:

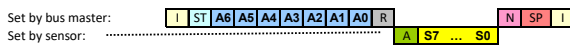

3. Data Read:

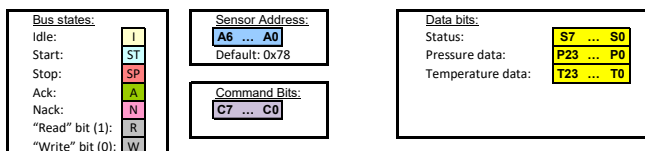

Interface Timing Diagram

Figure 4 - I2C Timing Diagram

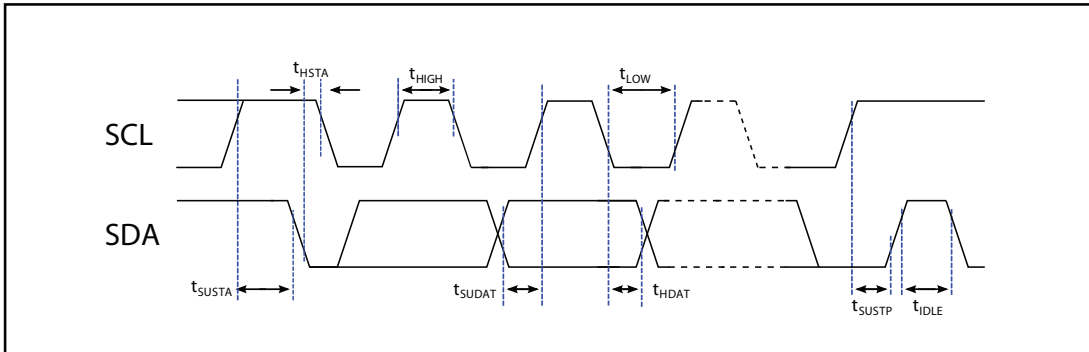

| PARAMETER | SYMBOL | MIN | TYP | MAX | UNITS |
|-----------------------|-------------|-----|-----|-----|-------|
| SCL frequency | f_{SCL} | 100 | - | 400 | KHz |
| SCL low width | t_{LOW} | 1.3 | - | - | us |
| SCL high width | t_{HIGH} | 0.6 | - | - | us |
| Start condition setup | t_{SUSTA} | 0.6 | - | - | us |
| Start condition hold | t_{HSTA} | 0.6 | - | - | us |
| Data setup to clock | t_{SUDAT} | 0.1 | - | - | us |
| Data hold to clock | t_{HDAT} | 0 | - | - | us |
| Stop condition setup | t_{SUSTP} | 0.6 | - | - | us |
| Bus idle time | t_{IDLE} | 2.0 | - | - | us |

How to Order

Refer to Table 5 for standard part numbers offered which includes the pressure range and package.

Example P/N with options: DLC-L05D-D4

Table 4 - Part Numbering Scheme:

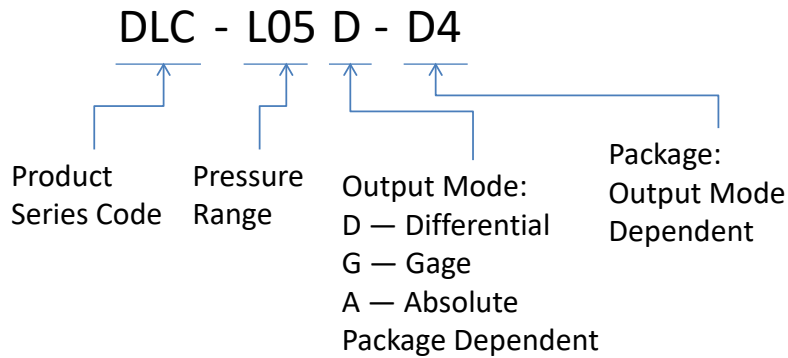

Where:

Pressure Range (D1, D3, D4 Package): All Differential Pressure Ranges

Pressure Range (U1, U2 Package): All Gage Pressure Ranges

Pressure Range (U5 Package): All Absolute Pressure Ranges

Table 5 - Standard Part Number Configurations

| | | | | | |
|------------|------------------------|------------------|------------------|------------------|------------------|
| D Packages | Low Pressure Products | DLC - L01 D - D1 | DLC - L01 D - D3 | DLC - L01 D - D4 | |
| | | DLC - L02 D - D1 | DLC - L02 D - D3 | DLC - L02 D - D4 | |
| | | DLC - L05 D - D1 | DLC - L05 D - D3 | DLC - L05 D - D4 | |
| | | DLC - L10 D - D1 | DLC - L10 D - D3 | DLC - L10 D - D4 | |
| | | DLC - L20 D - D1 | DLC - L20 D - D3 | DLC - L20 D - D4 | |
| | | DLC - L30 D - D1 | DLC - L30 D - D3 | DLC - L30 D - D4 | |
| | | DLC - L60 D - D1 | DLC - L60 D - D3 | DLC - L60 D - D4 | |
| | High Pressure Products | DLC - 005 D - D1 | DLC - 005 D - D3 | DLC - 005 D - D4 | |
| | | DLC - 015 D - D1 | DLC - 015 D - D3 | DLC - 015 D - D4 | |
| | | DLC - 030 D - D1 | DLC - 030 D - D3 | DLC - 030 D - D4 | |
| U Packages | Low Pressure Products | DLC - L01 G - U1 | DLC - L01 G - U2 | | |
| | | DLC - L02 G - U1 | DLC - L02 G - U2 | | |
| | | DLC - L05 G - U1 | DLC - L05 G - U2 | | |
| | | DLC - L10 G - U1 | DLC - L10 G - U2 | | |
| | | DLC - L20 G - U1 | DLC - L20 G - U2 | | |
| | | DLC - L30 G - U1 | DLC - L30 G - U2 | | |
| | | DLC - L60 G - U1 | DLC - L60 G - U2 | | |
| | High Pressure Products | DLC - 005 G - U1 | DLC - 005 G - U2 | DLC - 015 A - U5 | |
| | | DLC - 015 G - U1 | DLC - 015 G - U2 | DLC - 030 A - U5 | |
| | | DLC - 030 G - U1 | DLC - 030 G - U2 | DLC - 100 A - U5 | |
| | | | DLC - 100 G - U1 | DLC - 100 G - U2 | DLC - 150 A - U5 |
| | | | DLC - 150 G - U1 | DLC - 150 G - U2 | |

Product Identification on backside of device

All products are labeled via laser marking as seen in Figure 5.

Figure 6 details how to interpret the part marking code. Low pressure ranges from 1 to 60 inH2O are specified with code "L" and 5 to 150 psi high pressure products with code "H".

The pressure range will be indicated on the same line as the wafer number before the starting character "B".

Example: DLC-L05D-D4

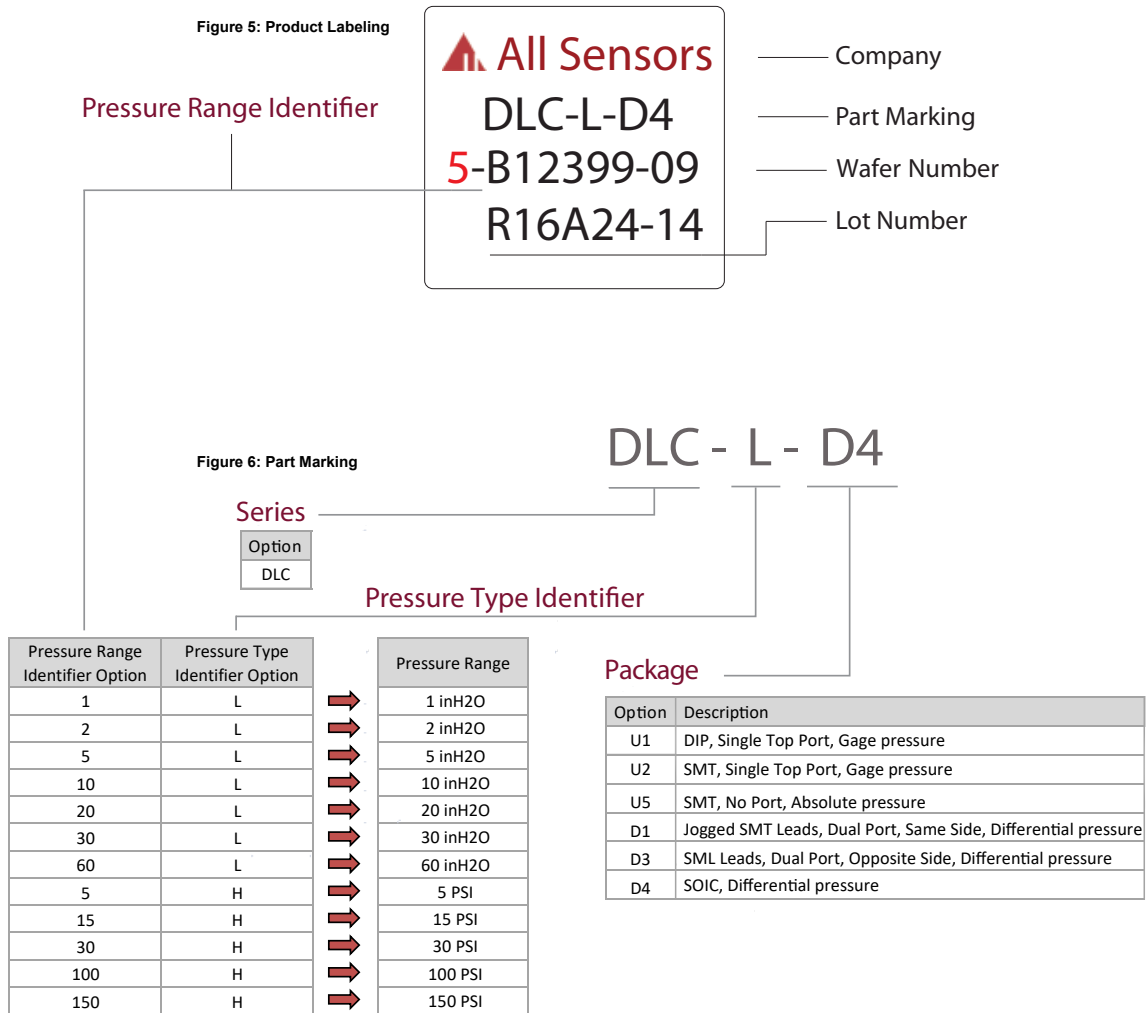

Package Drawings

D1 Package

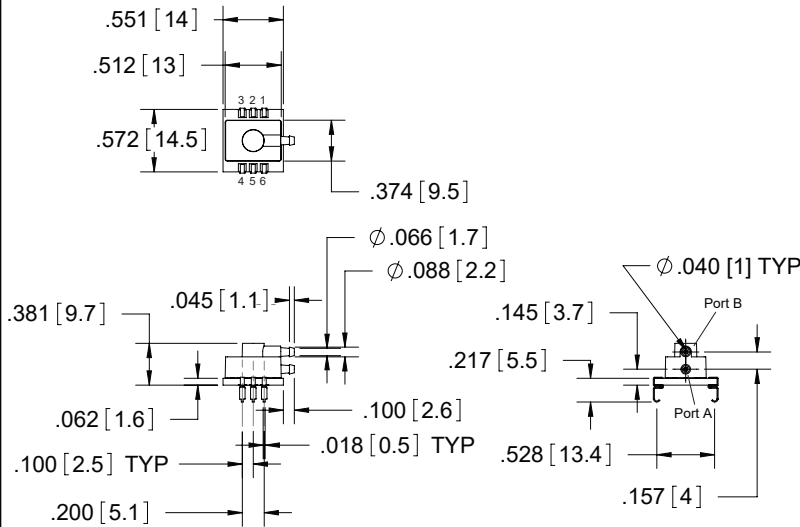

| Pin | Definition |
|-----|------------|
| 1 | N/C |
| 2 | SCL |
| 3 | SDA |
| 4 | EOC |
| 5 | VDD |
| 6 | VSS |

NOTES

- 1) Dimensions are in inches [mm].
- 2) For suggested pad layout, see drawing: PAD-20.

All Sensors

TITLE: D-Series Package

SIZE FILE NAME
A D1 Package

D3 Package

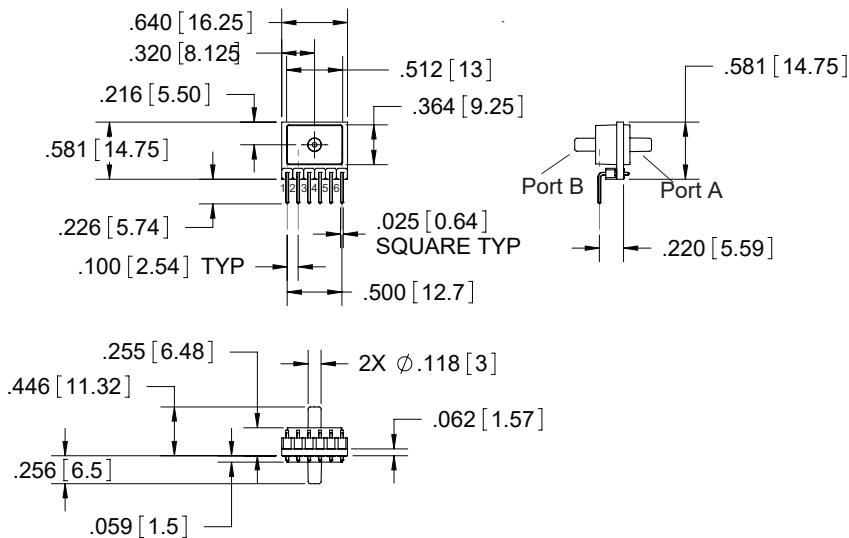

| Pin | Definition |
|-----|------------|
| 1 | N/C |
| 2 | SCL |
| 3 | SDA |
| 4 | EOC |
| 5 | VDD |
| 6 | VSS |

NOTES

- 1) Dimensions are in inches [mm].
- 2) For suggested pad layout, see drawing: PAD-21.

All Sensors

TITLE: D-Series Package

SIZE FILE NAME
A D3 Package

Package Drawings (Cont'd)

D4 Package

Top view dimensions: .104 [2.6], .102 [2.6], .209 [5.3], .050 [1.3] TYP, .350 [8.9], .016 [0.4] TYP, ϕ .039 [1], PIN1, 9, 8, 16.

Side view dimensions: .296 [7.5], .098 [2.5], ϕ .118 [3], ϕ .087 [2.2], .197 [5], .142 [3.6], .032 [0.8], .093 [2.4], .407 [10.3].

Pin connection diagram labels: Vs, SCL, SDA, EOC, Gnd, VDD, VSS, VDDDB, INN.

| Pin | Definition |
|-----|------------|
| 1 | INP |
| 2 | N/C |
| 3 | VSSB |
| 4 | SDA |
| 5 | SCL |
| 6 | EOC |
| 7 | N/C |
| 8 | N/C |
| 9 | N/C |
| 10 | VSS |
| 11 | VDD |
| 12 | N/C |
| 13 | VDDDB |
| 14 | INN |
| 15 | N/C |
| 16 | VDDDB |

NOTES

- 1) Dimensions are in inches [mm].
- 2) For suggested pad layout, see drawing: PAD-22
- 3) Sensors in this package require handling in accordance with MSL3.
- 4) Do not connect any signal to Pins 1, 3 & 14.
- 5) PCB must connect Pin 13 to Pin 16.

All Sensors

TITLE: D-Series Package

SIZE: **A** FILE NAME: D4 Package



Package Drawings (Cont'd)

U1 Package

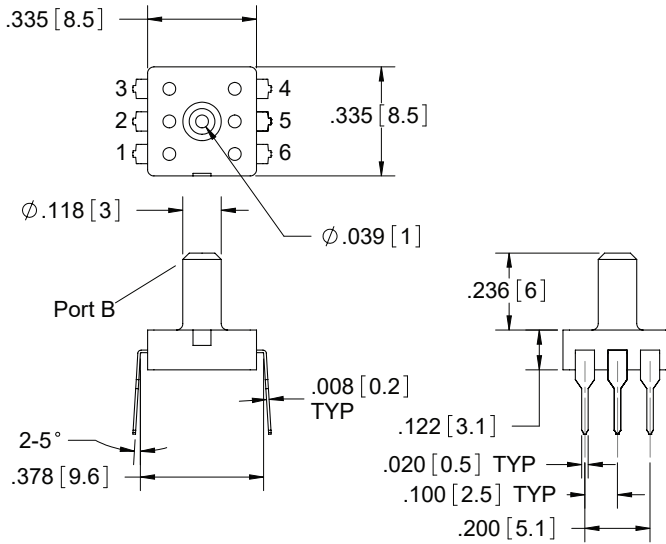

| Pin | Definition |
|-----|------------|
| 1 | N/C |
| 2 | SCL |
| 3 | SDA |
| 4 | EOC |
| 5 | VDD |
| 6 | VSS |

NOTES

- 1) Dimensions are in inches [mm].
- 2) For suggested pad layout, see drawing: PAD-23.

All Sensors

TITLE: U-Series Package

SIZE FILE NAME
A U1 Package

U2 Package

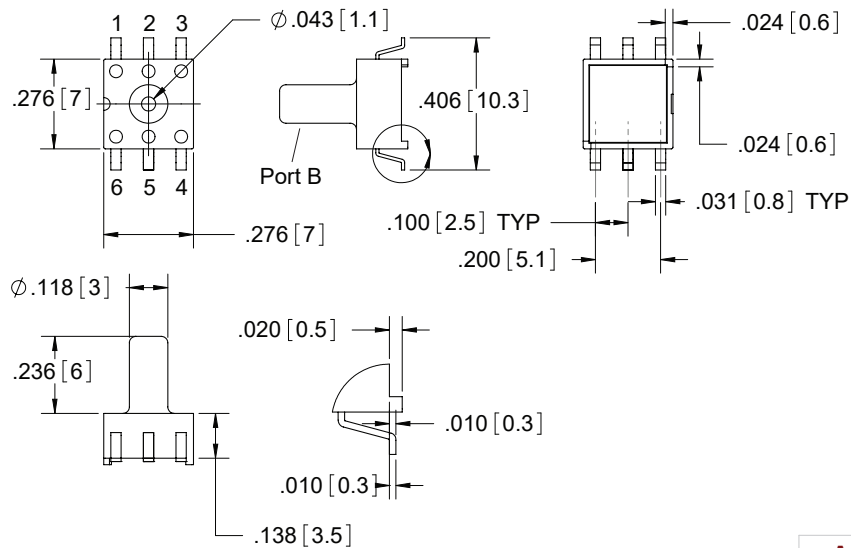

| Pin | Definition |
|-----|------------|
| 1 | N/C |
| 2 | SCL |
| 3 | SDA |
| 4 | EOC |
| 5 | VDD |
| 6 | VSS |

NOTES

- 1) Dimensions are in inches [mm].
- 2) For suggested pad layout, see drawing: PAD-24.

All Sensors

TITLE: U-Series Package

SIZE FILE NAME
A U2 Package

Package Drawings (Cont'd)

U5 Package

Top View Dimensions: [7] .276, [7] .276, [2.54] .100 TYP, [0.8] .031 TYP

Side View Dimensions: [10.3] .406, [3.5] .138, [0.5] .020, [0.25] .010, [0.25] .010

Front View Dimensions: [5.8] .228, [5.8] .228

| Pin | Definition |
|-----|------------|
| 1 | N/C |
| 2 | SCL |
| 3 | SDA |
| 4 | EOC |
| 5 | VDD |
| 6 | VSS |

NOTES

- 1) Dimensions are in inches [mm].
- 2) For suggested pad layout, see drawing: PAD-24.
- 3) Absolute pressure only.

| | |
|--------------------|------------------|
| All Sensors | |
| TITLE: | U-Series Package |
| SIZE: | FILE NAME |
| A | U5 Package |

Packing Options

TUBE

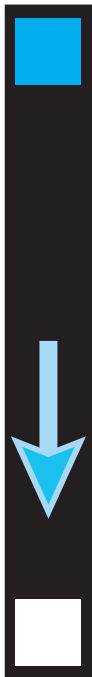

ALL PRODUCTS FOUND IN THIS DATASHEET ARE PACKAGED IN TUBES.

(Consult with factory for the option to ship in trays)



Pressure Tubing Recommendations

| Tubing Number | Recommended Tubing Sizes |
|---------------|--------------------------------------|
| 1 | 1/16" I.D. x 1/8" O.D. x 1/32" Wall |
| 2 | 3/32" I.D. x 5/32" O.D. x 1/32" Wall |

| Package | Tubing Number |
|---------|---------------|
| D1 | 1 |
| D3 | 2 |
| D4 | 2 |
| U1 | 2 |
| U2 | 2 |
| U5 | N/A |

Suggested Pad Layouts

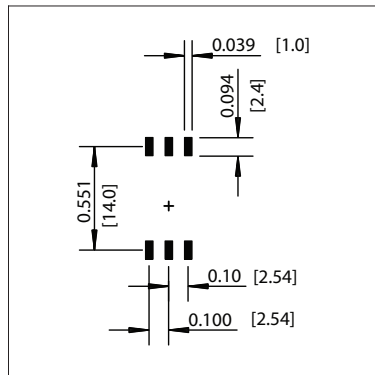

PAD-20

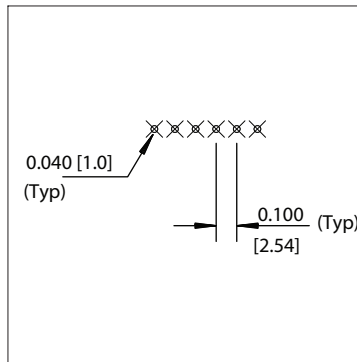

PAD-21

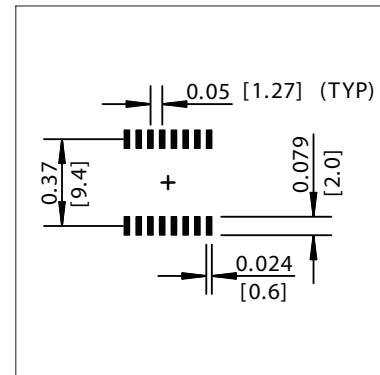

PAD-22

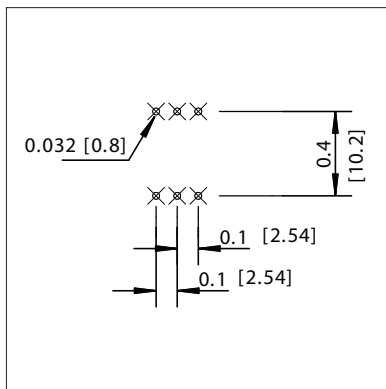

PAD-23

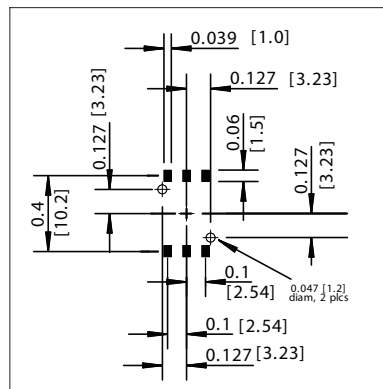

PAD-24

Dimensions are in inches [mm].

All Sensors reserves the right to make changes to any products herein. All Sensors does not assume any liability arising out of the application or use of any product or circuit described herein, neither does it convey any license under its patent rights nor the rights of others.