

Description

The PAM8016 is a haptic driver designed with low-latency, high-efficiency, and more drive strength capable of driving Linear Resonance Actuator (LRA) and Eccentric Rotating Mass (ERM) haptic elements, which are commonly used for tactile feedback in the portable market.

The PAM8016 support flexible inputs with differential, single-ended or PWM inputs to ease the host microcontroller in driving the haptic elements. PAM8016 is designed with filterless architecture that requires no external output filter, fewer external components, less PCB area and lower system costs, and simplifies application design. The PAM8016 also features short-circuit protection and thermal shutdown to provide the optimal protection.

The PAM8016 is available in U-FLGA1515-9 package.

Features

- Flexible Haptic/Vibra Driver
 - LRA (Linear Resonance Actuator)
 - ERM (Eccentric Rotating Mass)
- Wide Supply Voltage from 2.8V to 5.5V
- Fast Start-up Time
- Differential or Single-Ended Input Capable
- Efficient and Filterless Output Drive With High Efficiency—up to 90% at 8Ω Loading
- Low Shutdown Current < 1μA
- Few External Components Required
- Ultra Low EMI, -20dB Better Than FCC Class-B @ 300MHz
- Undervoltage Lockout, Short-Circuit Protection, and Thermal Shutdown Protection
- Available in Space-Saving U-FLGA1515-9 Package
- **Totally Lead-Free & Fully RoHS Compliant (Notes 1 & 2)**
- **Halogen and Antimony Free. “Green” Device (Note 3)**

- Notes:
1. No purposely added lead. EU Directive 2002/95/EC (RoHS), 2011/65/EU (RoHS 2) & 2015/863/EU (RoHS 3).compliant.
 2. See <https://www.diodes.com/quality/lead-free/> for more information about Diodes Incorporated’s definitions of Halogen- and Antimony-free, “Green” and Lead-free.
 3. Halogen- and Antimony-free “Green” products are defined as those which contain <900ppm bromine, <900ppm chlorine (<1500ppm total Br + Cl) and <1000ppm antimony compounds.

Typical Applications Circuit

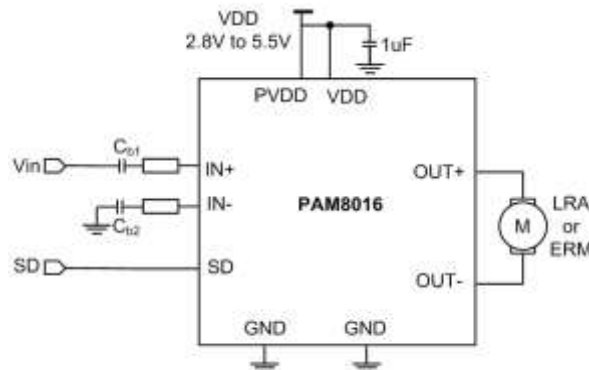

Pin Assignments

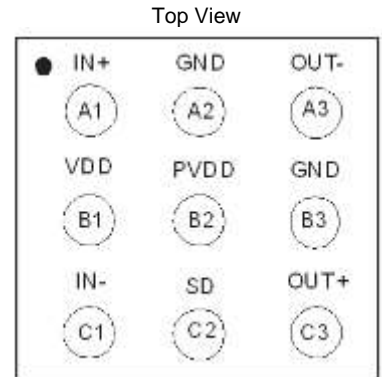

Applications

- Mobile Phones and Tablets
- Watches and Wearable Technology
- Joystick, Jog Dial Mice, or Peripheral Devices
- Electronic Point of Sale (ePOS)
- Vibration Alerts and Notifications
- Touch-Enabled Devices
- Human-Machine Interfaces for Industrial or Consumer Application

Pin Descriptions

Pin Number	U-FLGA1515-9	Function
A1	IN+	Positive Differential Input
A2	GND	Ground
A3	OUT-	Negative Output
B1	VDD	Power Supply
B2	PVDD	Power Supply
B3	GND	Ground
C1	IN-	Negative Differential Input
C2	SD	SD Terminal to Disable the Chip
C3	OUT+	Positive Output

Functional Block Diagram

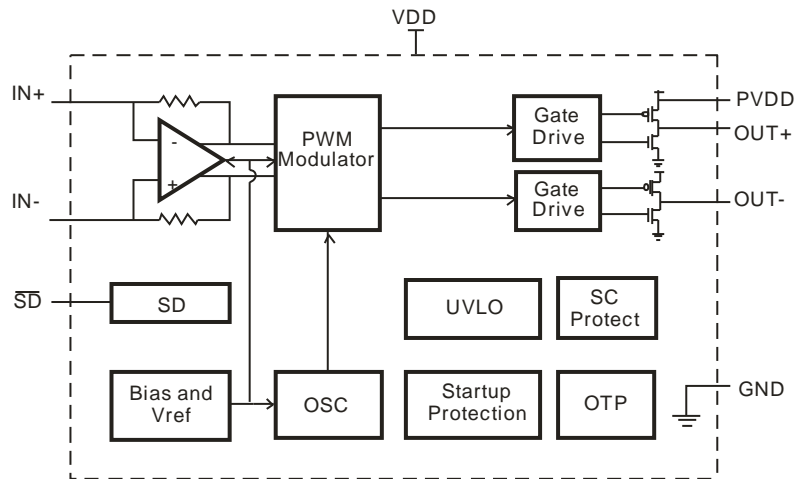

Absolute Maximum Ratings (@T_A = +25°C, unless otherwise specified.)

Parameter	Rating	Unit
Supply Voltage (VDD)	6.0	V
Input Voltage(IN+, IN-, SD)	-0.3 to VDD + 0.3	V
Storage Temperature	-65 to +150	°C
Maximum Junction Temperature	150	°C

Recommended Operating Conditions (@T_A = +25°C, unless otherwise specified.)

Symbol	Parameter	Min	Max	Unit
VDD	Supply Voltage	2.8	5.5	V
T _A	Operating Ambient Temperature Range	-25	+85	°C
T _J	Junction Temperature Range	-40	+125	°C

Electrical Characteristics (@TA=25°C, VDD=5V, Gain=18dB, RL=L(33μH)+R+L(33μH), unless otherwise noted.)

Symbol	Parameter	Test Conditions		MIN	TYP	MAX	UNIT
VDD	Supply Voltage	—		2.8	—	5.5	V
Po	Output Power	THD + N = 10%, f = 1kHz, R = 4Ω	VDD = 5.0V	—	3.0	—	W
			VDD = 3.6V	—	1.5	—	
			VDD = 3.2V	—	1.2	—	
		THD + N = 1%, f = 1kHz, R = 4Ω	VDD = 5.0V	—	2.4	—	W
			VDD = 3.6V	—	1.25	—	
			VDD = 3.2V	—	1.0	—	
		THD + N = 10%, f = 1kHz, R = 8Ω	VDD = 5.0V	—	1.75	—	W
			VDD = 3.6V	—	0.90	—	
			VDD = 3.2V	—	0.70	—	
		THD + N = 1%, f = 1kHz, R = 8Ω	VDD = 5.0V	—	1.40	—	W
			VDD = 3.6V	—	0.72	—	
			VDD = 3.2V	—	0.60	—	
THD+N	Total Harmonic Distortion Plus Noise	f = 1kHz	VDD = 5.0V, Po = 1W, R = 8Ω	—	0.17	—	%
			VDD = 3.6V, Po = 0.1W, R = 8Ω	—	0.16	—	
			VDD = 3.2V, Po = 0.1W, R = 8Ω	—	0.14	—	
		f = 1kHz	VDD = 5.0V, Po = 0.5W, R = 4Ω	—	0.14	—	%
			VDD = 3.6V, Po = 0.2W, R = 4Ω	—	0.16	—	
			VDD = 3.2V, Po = 0.1W, R = 4Ω	—	0.17	—	
PSRR	Power Supply Ripple Rejection	VDD = 3.6V, Inputs AC-Grounded with C = 1μF	f = 217Hz	—	-68	—	dB
			f = 1kHz	—	-70	—	
			f = 10kHz	—	-67	—	
Dyn	Dynamic Range	VDD = 5V, THD = 1%, R = 8Ω	f = 1kHz	—	95	—	dB
Vn	Output Noise	Inputs AC-Grounded	No A-Weighting	—	170	—	μV
			A-Weighting	—	130	—	
η	Efficiency	RL = 8Ω, THD = 10%	f = 1kHz	—	93	—	%
		RL = 4Ω, THD = 10%		—	86	—	
IQ	Quiescent Current	VDD = 5V	No Load	—	5	—	mA
I _{sd}	Shutdown Current	VDD = 2.8V to 5V	SD = 0V	—	—	1	μA
R _{dson}	Static Drain-to Source On-State Resistor	High-Side PMOS, I = 500mA	VDD = 5.0V	—	325	—	mΩ
		Low-Side NMOS, I = 500mA	VDD = 5.0V	—	200	—	mΩ
f _{sw}	Output Switching Frequency	VDD = 2.8V to 5V	—	—	400	—	kHz
T _{on}	Startup Time	—	—	—	4	—	ms
G _v	Closed-Loop Gain	VDD=2.8V to 5V	—	—	300K/R _{in}	—	V/V
R _{IN}	Input Impedance	VDD=2.8V to 5V	—	—	28.5	—	KΩ
V _{out}	Differential Output Voltage	THD + N = 10%, f = 1kHz, R = 8Ω	VDD = 3.6V	—	2.68	—	V _{rms}
V _{os}	Output Offset Voltage	Input AC-Ground, VDD = 5V	—	—	—	20	mV
V _{IH}	SD Input High Voltage	VDD = 5V	—	1.4	—	—	V
V _{IL}	SD Input Low Voltage	VDD = 5V	—	—	—	1.0	

Performance Characteristics (@ TA = 25°C, VDD = 5V, Gain = 18dB, RL = L(33μH) + R + L(33μH), unless otherwise noted.)

THD+N vs Output Power (RL=4Ω)

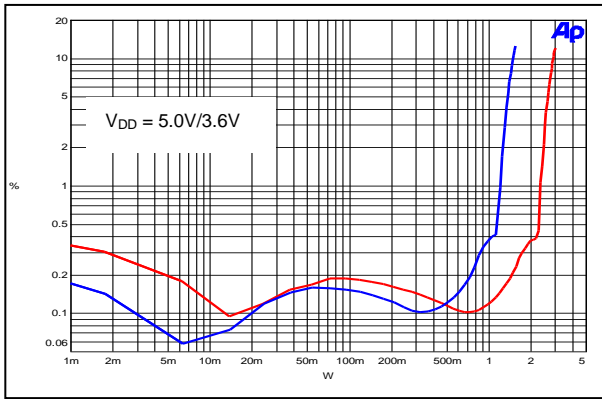

THD+N vs Output Power (RL=8Ω)

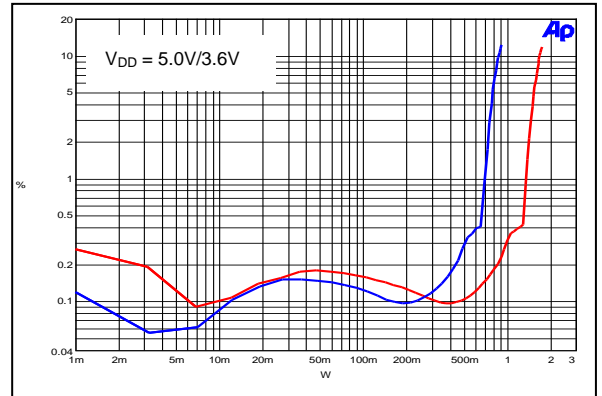

THD+N vs Frequency

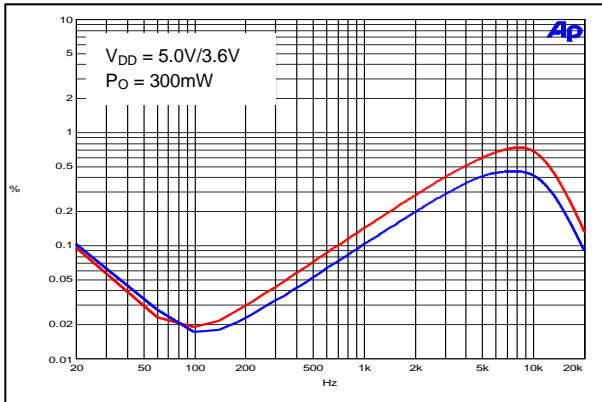

PSRR vs Frequency

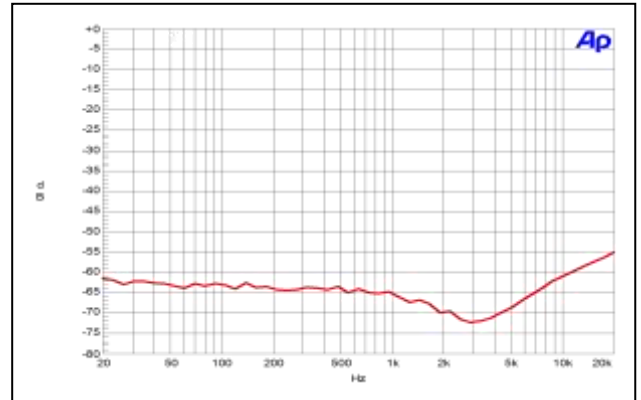

Frequency Response

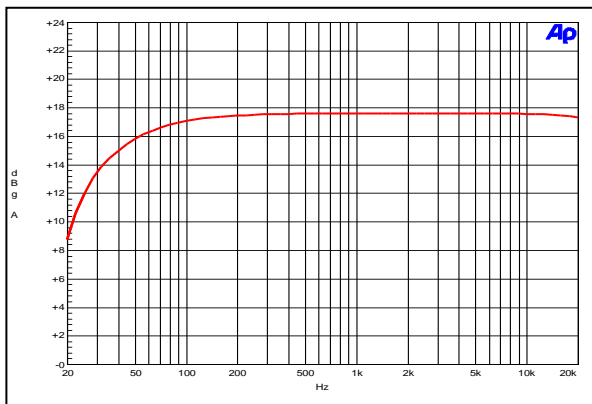

Noise Floor

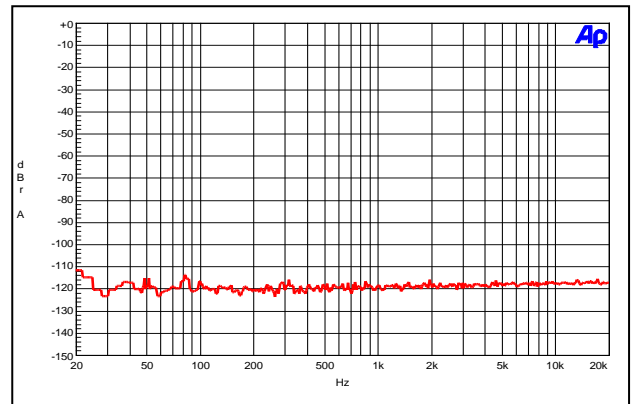

Performance Characteristics (@ TA = 25°C, VDD = 5V, Gain = 18dB, RL = L(33μH) + R + L(33μH), unless otherwise noted.)

Efficiency vs Output Power (RL=4Ω)

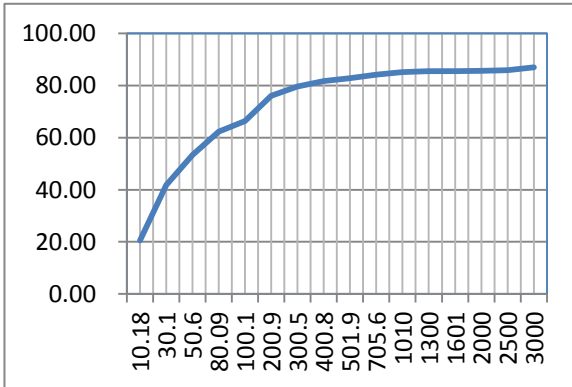

Efficiency vs Output Power (RL=8Ω)

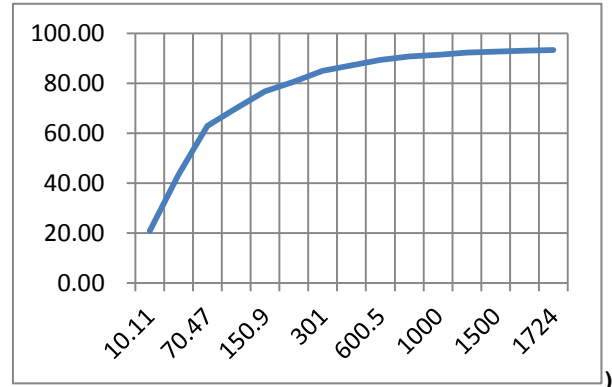

Quiescent Current vs Supply Voltage

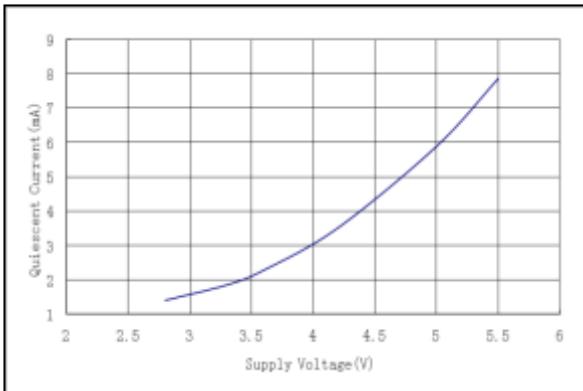

OSC Frequency vs Supply Voltage

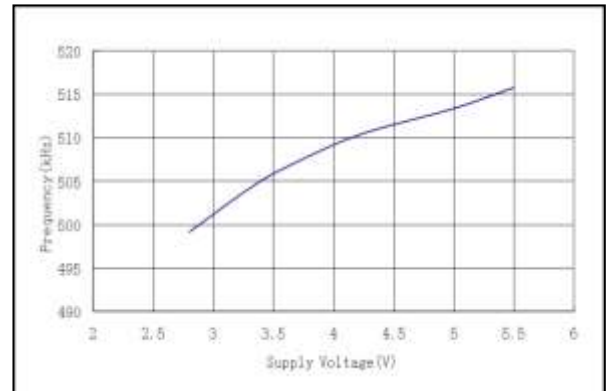

Startup Response

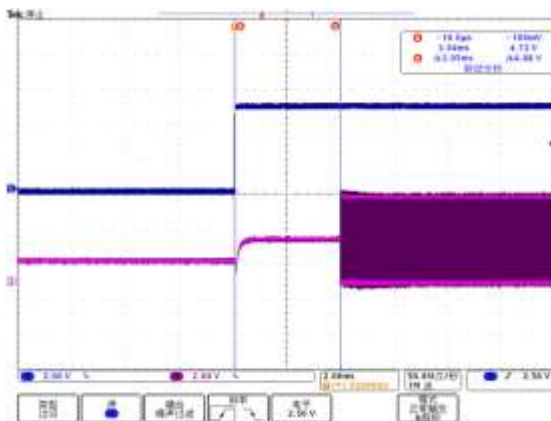

Shutdown Response

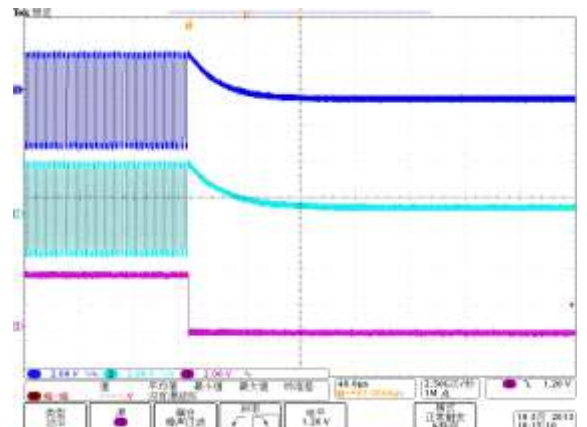

Application Information

Overview

The typical application for applying PAM8016 haptic driver is to utilize the application processor in a touch-enabled or haptic-capable system and execute haptic effects control to drive PAM8016 with predefined haptic control data. The PAM8016 supports typical analog-control interface with analog inputs and SD control to operate as instructed by the application processor. A system designer can choose to activate the application processor by playing low-latency effects (such as an action triggered by a physical button) or predefined analog data patterns through the analog interface (differential, single-ended, or PWM inputs) to PAM8016. The PAM8016 generates corresponding output voltages for driving the haptic element accordingly.

The application diagram shown in Figure 1 illustrates the connection between the application processor and PAM8016. For nominal-differential or single-ended analog-control signals generated by the application processor only the typical input decoupling capacitors, C_{b1} and C_{b2} , are required for screening out unintended noises to PAM8016 (as shown in the left of Figure 1).

However, if the PWM signals are provided, the low-pass RC filter is suggested to filter out the high-frequency noises induced by PWM driving signal (as shown in the right of Figure 1). Because typical haptic elements operate in the range of a few hundred hertz (~300Hz or below), it is suggested to set the cut-off frequency for the low-pass RC filter network ($R_1 C_1$ and $R_2 C_2$) to 10KHz or less to eliminate the unintended noise impact while driving the haptic element.

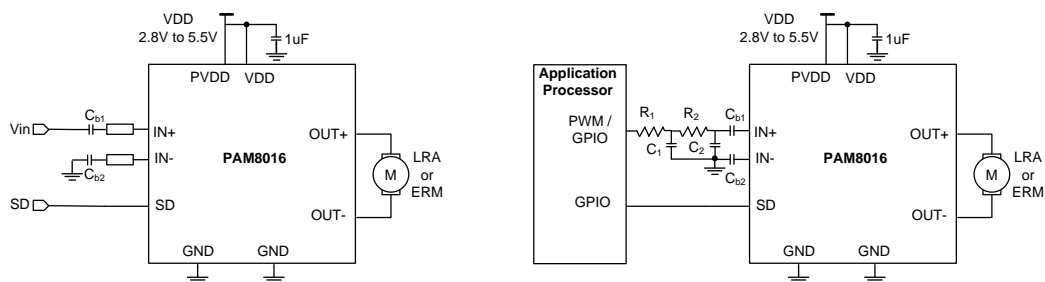

Figure 1: PAM8016 Simplified Configurations for Typical Single-Ended Analog Inputs or PWM Inputs

Input Capacitors (C_i)

In the typical application an input capacitor, C_i , is required to allow the amplifier to bias the input signal to the proper DC level for optimum operation. In this case, C_i and the minimum input impedance R_i form a high-pass filter with the corner frequency determined in the follow equation:

$$f_c = \frac{1}{(2\pi R_i C_i)}$$

It is important to consider the value of C_i as it directly affects the low-frequency performance of the circuit. For example when R_i is 150k Ω , the specification calls for a flat bass response down to 150Hz. Equation is reconfigured as followed:

$$C_i = \frac{1}{(2\pi R_i f_c)}$$

When input resistance variation is considered, the C_i is 7nF, so one would likely choose a value of 10nF. A further consideration for this capacitor is the leakage path from the input source through the input network (C_i , $R_i + R_f$) to the load. This leakage current creates a DC offset voltage at the input to the amplifier that reduces useful headroom, especially in high-gain applications. For this reason, a low-leakage tantalum or ceramic capacitor is the best choice. When polarized capacitors are used, the positive side of the capacitor should face the amplifier input in most applications as the DC level is held at $VDD/2$, which is likely higher than the source DC level. Note that it is important to confirm the capacitor polarity in the application.

Decoupling Capacitor (C_S)

The PAM8016 is a high-performance haptic driver that suggests adequate power-supply decoupling to ensure the output total harmonic distortion (THD) is as low as possible. Power supply decoupling also prevents the oscillations caused by long lead length between the driver and the haptic elements.

The optimum decoupling is achieved by using two different types of capacitors that target the different types of noise the power supply leads. For higher-frequency transients, spikes, or digital hash on the line, a good low-equivalent series resistance (ESR) ceramic capacitor, typically 1 μ F, can be placed as close as possible to the device VDD pin for the best operation. For filtering lower-frequency noise signals, a large ceramic capacitor of 10 μ F or greater placed near the haptic driver is recommended.

Application Information (continued)

How to Reduce EMI

Most applications require a ferrite bead filter for EMI elimination shown at Figure 2 if any concern for EMI issue. The ferrite filter reduces EMI around 1MHz and higher. When selecting a ferrite bead, choose one with high impedance at high frequencies but low impedance at low frequencies.

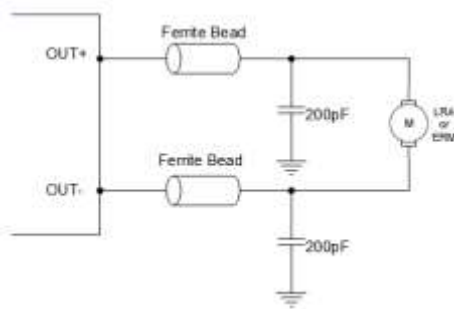

Figure 2: Ferrite Bead Filter to Reduce EMI

Shutdown Operation

To reduce power consumption when not in use, the PAM8016 contains shutdown circuitry when logic low is placed on the SD pin. By switching the shutdown pin connected to GND, the PAM8016 supply current draw is minimized in idle mode.

Undervoltage Lockout (UVLO)

The PAM8016 incorporates circuitry designed to detect low supply voltage. When the supply voltage drops to 2V or below, the PAM8016 goes into a state of shutdown. The device comes out of its shutdown state and restores to normal function only when VDD is higher than 2.2V.

Short-Circuit Protection (SCP)

The PAM8016 has short-circuit protection circuitry on the outputs to prevent the device from damage when output-to-output shorts or output-to-GND shorts occur. When a short circuit occurs, the device immediately goes into shutdown state. Once the short is removed, the device is reactivated.

Over Temperature Protection (OTP)

Thermal protection on the PAM8016 prevents the device from damage when the internal die temperature exceeds 150°C. There is a 15°C tolerance on this trip point from device to device. Once the die temperature exceeds the set point, the device enters the shutdown state, and the outputs are disabled. This is not a latched fault. The thermal fault is cleared once the temperature of the die decreased by 40°C. This large hysteresis prevents motor boating sound, and the device begins normal operation at this point with no external system interaction.

Ordering Information

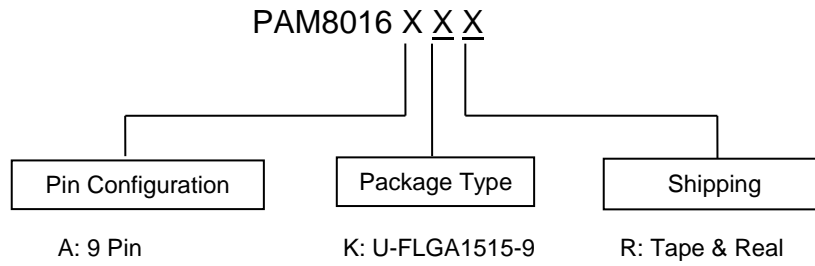

Part Number	Package	Standard Package
PAM8016AKR	U-FLGA1515-9	3,000Units/Tape&Real

Marking Information

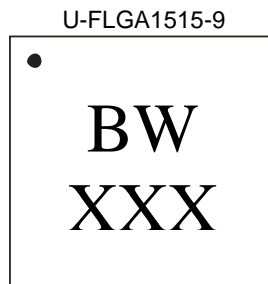

BW: Product Code

XXX: Internal code

Package Outline Dimensions (All dimensions in mm.)

Please see <http://www.diodes.com/package-outlines.html> for the latest version.

U-FLGA1515-9

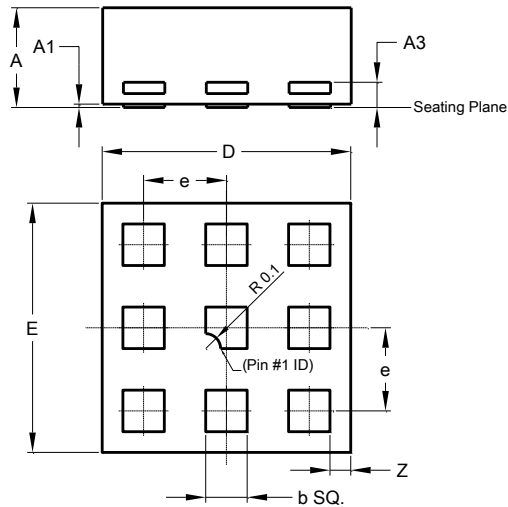

U-FLGA1515-9			
Dim	Min	Max	Typ
A	0.55	0.65	0.60
A1	0	0.05	0.02
A3	0.13 BSC		
b	0.20	0.30	0.25
D	1.45	1.55	1.50
E	1.45	1.55	1.50
e	0.50 BSC		
Z	0.125 BSC		
All Dimensions in mm			

Suggested Pad Layout

Please see <http://www.diodes.com/package-outlines.html> for the latest version.

U-FLGA1515-9

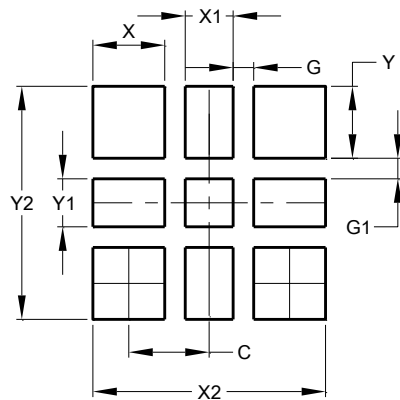

Dimensions	Value (in mm)
C	0.587
G	0.150
G1	0.150
X	0.525
X1	0.350
X2	1.700
Y	0.525
Y1	0.350
Y2	1.700

IMPORTANT NOTICE

DIODES INCORPORATED MAKES NO WARRANTY OF ANY KIND, EXPRESS OR IMPLIED, WITH REGARDS TO THIS DOCUMENT, INCLUDING, BUT NOT LIMITED TO, THE IMPLIED WARRANTIES OF MERCHANTABILITY AND FITNESS FOR A PARTICULAR PURPOSE (AND THEIR EQUIVALENTS UNDER THE LAWS OF ANY JURISDICTION).

Diodes Incorporated and its subsidiaries reserve the right to make modifications, enhancements, improvements, corrections or other changes without further notice to this document and any product described herein. Diodes Incorporated does not assume any liability arising out of the application or use of this document or any product described herein; neither does Diodes Incorporated convey any license under its patent or trademark rights, nor the rights of others. Any Customer or user of this document or products described herein in such applications shall assume all risks of such use and will agree to hold Diodes Incorporated and all the companies whose products are represented on Diodes Incorporated website, harmless against all damages.

Diodes Incorporated does not warrant or accept any liability whatsoever in respect of any products purchased through unauthorized sales channel. Should Customers purchase or use Diodes Incorporated products for any unintended or unauthorized application, Customers shall indemnify and hold Diodes Incorporated and its representatives harmless against all claims, damages, expenses, and attorney fees arising out of, directly or indirectly, any claim of personal injury or death associated with such unintended or unauthorized application.

Products described herein may be covered by one or more United States, international or foreign patents pending. Product names and markings noted herein may also be covered by one or more United States, international or foreign trademarks.

This document is written in English but may be translated into multiple languages for reference. Only the English version of this document is the final and determinative format released by Diodes Incorporated.

LIFE SUPPORT

Diodes Incorporated products are specifically not authorized for use as critical components in life support devices or systems without the express written approval of the Chief Executive Officer of Diodes Incorporated. As used herein:

A. Life support devices or systems are devices or systems which:

1. are intended to implant into the body, or
2. support or sustain life and whose failure to perform when properly used in accordance with instructions for use provided in the labeling can be reasonably expected to result in significant injury to the user.

B. A critical component is any component in a life support device or system whose failure to perform can be reasonably expected to cause the failure of the life support device or to affect its safety or effectiveness.

Customers represent that they have all necessary expertise in the safety and regulatory ramifications of their life support devices or systems, and acknowledge and agree that they are solely responsible for all legal, regulatory and safety-related requirements concerning their products and any use of Diodes Incorporated products in such safety-critical, life support devices or systems, notwithstanding any devices- or systems-related information or support that may be provided by Diodes Incorporated. Further, Customers must fully indemnify Diodes Incorporated and its representatives against any damages arising out of the use of Diodes Incorporated products in such safety-critical, life support devices or systems.

Copyright © 2018, Diodes Incorporated

www.diodes.com

Mouser Electronics

Authorized Distributor

Click to View Pricing, Inventory, Delivery & Lifecycle Information:

[Diodes Incorporated:](#)

[PAM8016AKR](#)