

# Technische Information / Technical Information

IGBT-Module  
IGBT-Modules

## BSM150GT120DLC

eupec



**vorläufige Daten**  
**preliminary data**

### Höchstzulässige Werte / Maximum rated values

#### Elektrische Eigenschaften / Electrical properties

Kollektor-Emitter-Sperrspannung collector-emitter voltage		$V_{CES}$	1200	V
Kollektor-Dauergleichstrom DC-collector current	$T_C = 80^\circ\text{C}$	$I_{C,nom.}$	150	A
	$T_C = 25^\circ\text{C}$	$I_C$	250	A
Periodischer Kollektor Spitzenstrom repetitive peak collector current	$t_p = 1\text{ ms}, T_C = 80^\circ\text{C}$	$I_{CRM}$	300	A
Gesamt-Verlustleistung total power dissipation	$T_C = 25^\circ\text{C}, \text{ Transistor}$	$P_{tot}$	1000	W
Gate-Emitter-Spitzenspannung gate-emitter peak voltage		$V_{GES}$	+/- 20V	V
Dauergleichstrom DC forward current		$I_F$	150	A
Periodischer Spitzenstrom repetitive peak forw. current	$t_p = 1\text{ ms}$	$I_{FRM}$	300	A
Grenzlastintegral der Diode $I^2t$ - value, Diode	$V_R = 0V, t_p = 10\text{ms}, T_{vj} = 125^\circ\text{C}$	$I^2t$	4,75	$\text{kA}^2\text{s}$
Isolations-Prüfspannung insulation test voltage	RMS, $f = 50\text{ Hz}, t = 1\text{ min.}$	$V_{ISOL}$	2,5	kV

### Charakteristische Werte / Characteristic values

#### Transistor / Transistor

			min.	typ.	max.	
Kollektor-Emitter Sättigungsspannung collector-emitter saturation voltage	$I_C = 150A, V_{GE} = 15V, T_{vj} = 25^\circ\text{C}$	$V_{CE\text{ sat}}$	-	2,1	2,6	V
	$I_C = 150A, V_{GE} = 15V, T_{vj} = 125^\circ\text{C}$		-	2,4	t.b.d.	V
Gate-Schwellenspannung gate threshold voltage	$I_C = 6\text{mA}, V_{CE} = V_{GE}, T_{vj} = 25^\circ\text{C}$	$V_{GE(th)}$	4,5	5,5	6,5	V
Gateladung gate charge	$V_{GE} = -15V...+15V$	$Q_G$	-	t.b.d.	-	$\mu\text{C}$
Eingangskapazität input capacitance	$f = 1\text{MHz}, T_{vj} = 25^\circ\text{C}, V_{CE} = 25V, V_{GE} = 0V$	$C_{ies}$	-	10	-	nF
Rückwirkungskapazität reverse transfer capacitance	$f = 1\text{MHz}, T_{vj} = 25^\circ\text{C}, V_{CE} = 25V, V_{GE} = 0V$	$C_{res}$	-	t.b.d.	-	nF
Kollektor-Emitter Reststrom collector-emitter cut-off current	$V_{CE} = 1200V, V_{GE} = 0V, T_{vj} = 25^\circ\text{C}$	$I_{CES}$	-	10	500	$\mu\text{A}$
	$V_{CE} = 1200V, V_{GE} = 0V, T_{vj} = 125^\circ\text{C}$		-	500	-	$\mu\text{A}$
Gate-Emitter Reststrom gate-emitter leakage current	$V_{CE} = 0V, V_{GE} = 20V, T_{vj} = 25^\circ\text{C}$	$I_{GES}$	-	-	400	nA

prepared by: Mark Münzer

date of publication: 08.02.1999

approved by: Jens Thureau

revision: 1

# Technische Information / Technical Information

IGBT-Module  
IGBT-Modules

## BSM150GT120DLC

eupec



**vorläufige Daten**  
**preliminary data**

### Charakteristische Werte / Characteristic values

#### Transistor / Transistor

			min.	typ.	max.	
Einschaltverzögerungszeit (ind. Last) turn on delay time (inductive load)	$I_C = 150A, V_{CC} = 600V$	$t_{d,on}$	-	0,05	-	$\mu s$
	$V_{GE} = \pm 15V, R_G = 5,6\Omega, T_{vj} = 25^\circ C$		-	0,06	-	$\mu s$
Anstiegszeit (induktive Last) rise time (inductive load)	$I_C = 150A, V_{CC} = 600V$	$t_r$	-	0,05	-	$\mu s$
	$V_{GE} = \pm 15V, R_G = 5,6\Omega, T_{vj} = 125^\circ C$		-	0,07	-	$\mu s$
Abschaltverzögerungszeit (ind. Last) turn off delay time (inductive load)	$I_C = 150A, V_{CC} = 600V$	$t_{d,off}$	-	0,57	-	$\mu s$
	$V_{GE} = \pm 15V, R_G = 5,6\Omega, T_{vj} = 125^\circ C$		-	0,57	-	$\mu s$
Fallzeit (induktive Last) fall time (inductive load)	$I_C = 150A, V_{CC} = 600V$	$t_f$	-	0,04	-	$\mu s$
	$V_{GE} = \pm 15V, R_G = 5,6\Omega, T_{vj} = 125^\circ C$		-	0,05	-	$\mu s$
Einschaltverlustenergie pro Puls turn-on energy loss per pulse	$I_C = 150A, V_{CC} = 600V, V_{GE} = 15V$ $R_G = 5,6\Omega, T_{vj} = 125^\circ C, L_S = 60nH$	$E_{on}$	-	17	-	mWs
Abschaltverlustenergie pro Puls turn-off energy loss per pulse	$I_C = 150A, V_{CC} = 600V, V_{GE} = 15V$ $R_G = 5,6\Omega, T_{vj} = 125^\circ C, L_S = 60nH$	$E_{off}$	-	18	-	mWs
Kurzschlußverhalten SC Data	$t_p \leq 10\mu sec, V_{GE} \leq 15V, R_G = 5,6\Omega$ $T_{vj} \leq 125^\circ C, V_{CC} = 900V, V_{CEmax} = V_{CES} - L_{sCE} \cdot di/dt$	$I_{SC}$	-	950	-	A
Modulinduktivität stray inductance module		$L_{sCE}$	-	35	-	nH
Modul Leitungswiderstand, Anschlüsse – Chip module lead resistance, terminals – chip	$T_C = 25^\circ C$	$R_{CC+EE}$	-	1,1	-	m $\Omega$

### Charakteristische Werte / Characteristic values

#### Diode / Diode

			min.	typ.	max.	
Durchlaßspannung forward voltage	$I_F = 150A, V_{GE} = 0V, T_{vj} = 25^\circ C$	$V_F$	-	1,8	2,3	V
	$I_F = 150A, V_{GE} = 0V, T_{vj} = 125^\circ C$		-	1,7	t.b.d.	V
Rückstromspitze peak reverse recovery current	$I_F = 150A, -di_F/dt = 3100A/\mu sec$	$I_{RM}$	-	180	-	A
	$V_R = 600V, V_{GE} = -15V, T_{vj} = 25^\circ C$ $V_R = 600V, V_{GE} = -15V, T_{vj} = 125^\circ C$		-	220	-	A
Sperrverzögerungsladung recovered charge	$I_F = 150A, -di_F/dt = 3100A/\mu sec$	$Q_r$	-	17	-	$\mu As$
	$V_R = 600V, V_{GE} = -15V, T_{vj} = 25^\circ C$ $V_R = 600V, V_{GE} = -15V, T_{vj} = 125^\circ C$		-	32	-	$\mu As$
Abschaltenergie pro Puls reverse recovery energy	$I_F = 150A, -di_F/dt = 3100A/\mu sec$	$E_{rec}$	-	4	-	mWs
	$V_R = 600V, V_{GE} = -15V, T_{vj} = 25^\circ C$ $V_R = 600V, V_{GE} = -15V, T_{vj} = 125^\circ C$		-	10	-	mWs

# Technische Information / Technical Information

IGBT-Module  
IGBT-Modules

## BSM150GT120DLC

eupec

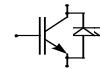

**vorläufige Daten**  
**preliminary data**

### Thermische Eigenschaften / Thermal properties

				min.	typ.	max.	
Innerer Wärmewiderstand thermal resistance, junction to case	Transistor / transistor, DC	$R_{thJC}$	-	-	0,125	K/W	
	Diode/Diode, DC		-	-	0,275	K/W	
Übergangs-Wärmewiderstand thermal resistance, case to heatsink	pro Modul / per module $\lambda_{paste} = 1 \text{ W/m} \cdot \text{K}$ / $\lambda_{grease} = 1 \text{ W/m} \cdot \text{K}$	$R_{thCK}$	-	0,009	-	K/W	
Höchstzulässige Sperrschichttemperatur maximum junction temperature		$T_{vj}$	-	-	150	°C	
Betriebstemperatur operation temperature		$T_{op}$	-40	-	125	°C	
Lagertemperatur storage temperature		$T_{stg}$	-40	-	150	°C	

### Mechanische Eigenschaften / Mechanical properties

Gehäuse, siehe Anlage case, see appendix						
Innere Isolation internal insulation					AL <sub>2</sub> O <sub>3</sub>	
CTI comperative tracking index					225	
Anzugsdrehmoment f. mech. Befestigung mounting torque	screw M5	M1	3		6	Nm
Anzugsdrehmoment f. elektr. Anschlüsse terminal connection torque						Nm
Gewicht weight		G			300	g

Mit dieser technischen Information werden Halbleiterbauelemente spezifiziert, jedoch keine Eigenschaften zugesichert. Sie gilt in Verbindung mit den zugehörigen Technischen Erläuterungen.

This technical information specifies semiconductor devices but promises no characteristics. It is valid in combination with the belonging technical notes.

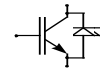

**Ausgangskennlinie (typisch)**  
**Output characteristic (typical)**

$I_C = f(V_{CE})$   
 $V_{GE} = 15V$

**vorläufige Daten**  
**preliminary data**

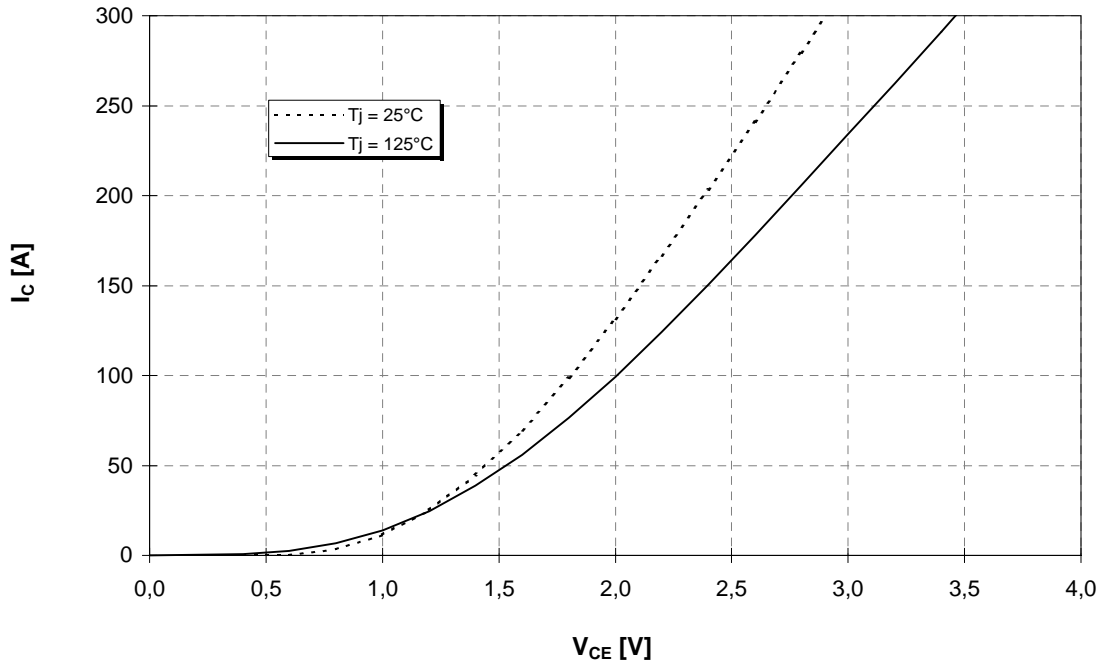

**Ausgangskennlinienfeld (typisch)**  
**Output characteristic (typical)**

$I_C = f(V_{CE})$   
 $T_{vj} = 125^\circ C$

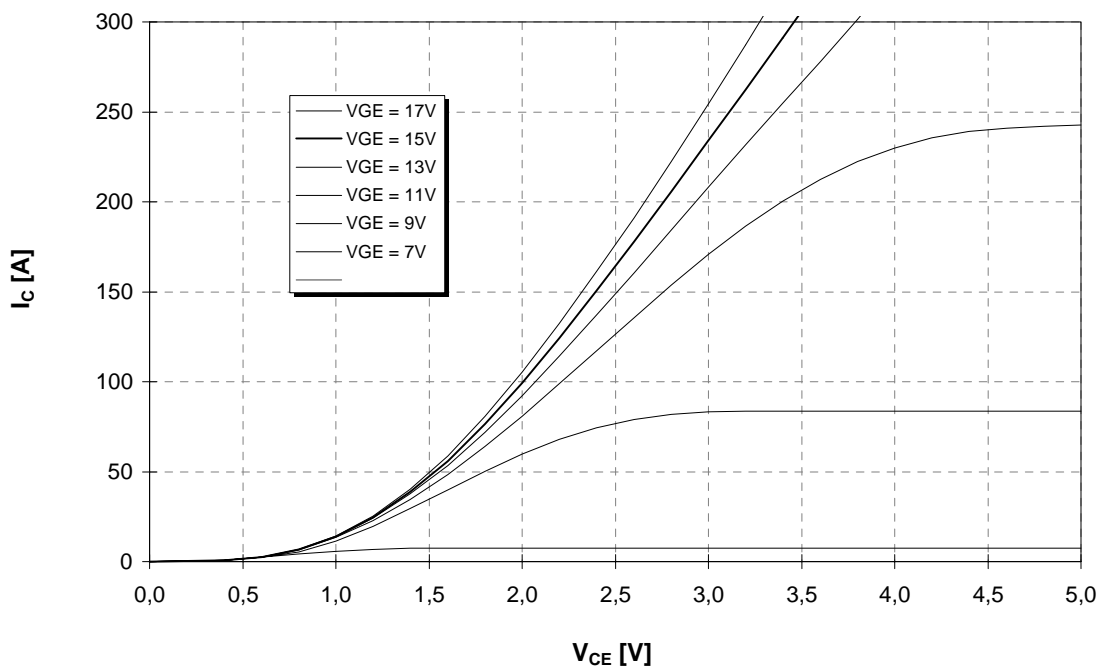



**vorläufige Daten**  
**preliminary data**

**Übertragungscharakteristik (typisch)**  
**Transfer characteristic (typical)**

$I_C = f(V_{GE})$   
 $V_{CE} = 20V$

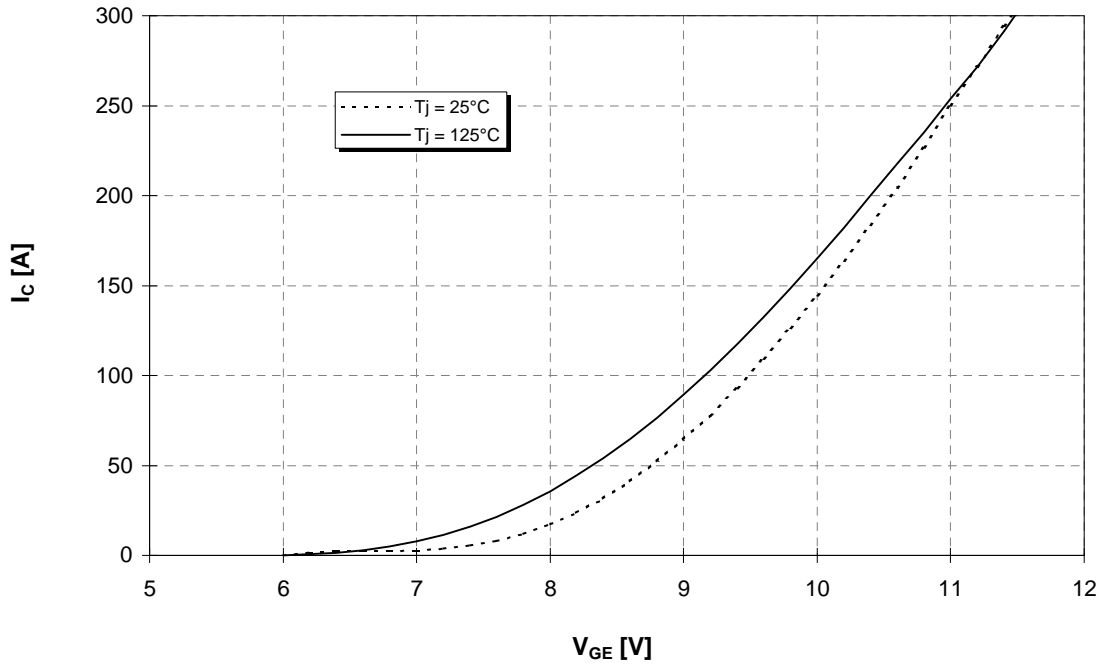

**Durchlaßkennlinie der Inversdiode (typisch)**  
**Forward characteristic of inverse diode (typical)**

$I_F = f(V_F)$

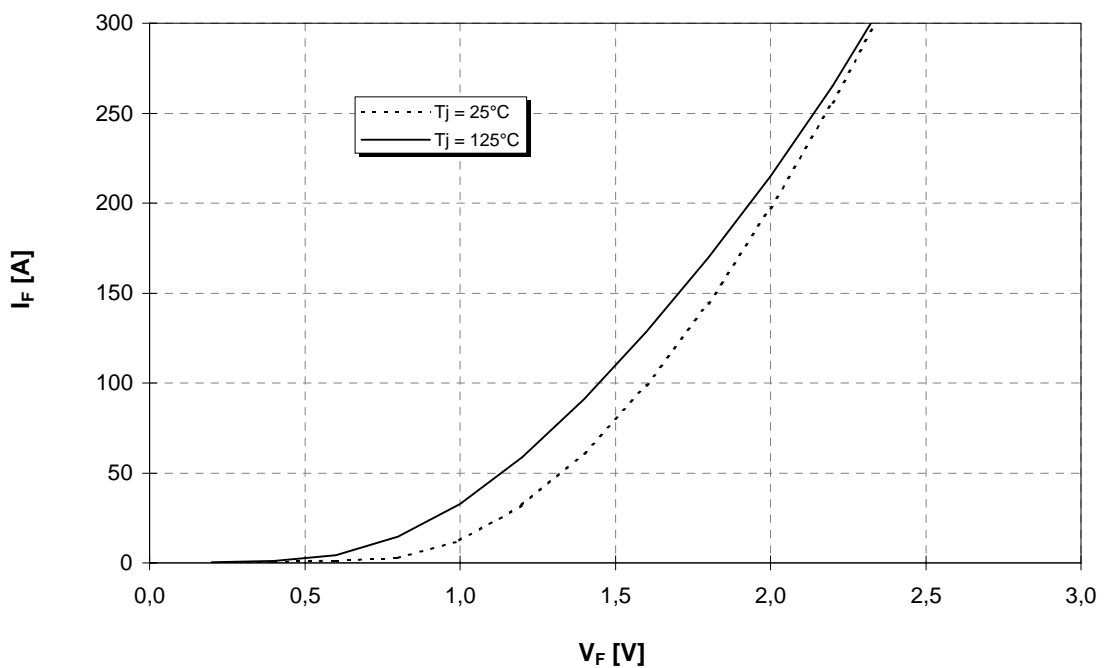



**vorläufige Daten**  
**preliminary data**

**Schaltverluste (typisch)  $E_{on} = f(I_C)$ ,  $E_{off} = f(I_C)$ ,  $E_{rec} = f(I_C)$**   
**Switching losses (typical)  $V_{GE}=15V$ ,  $R_{gon} = R_{goff} = 5,6 \Omega$ ,  $V_{CE} = 600V$ ,  $T_J = 125^\circ C$**

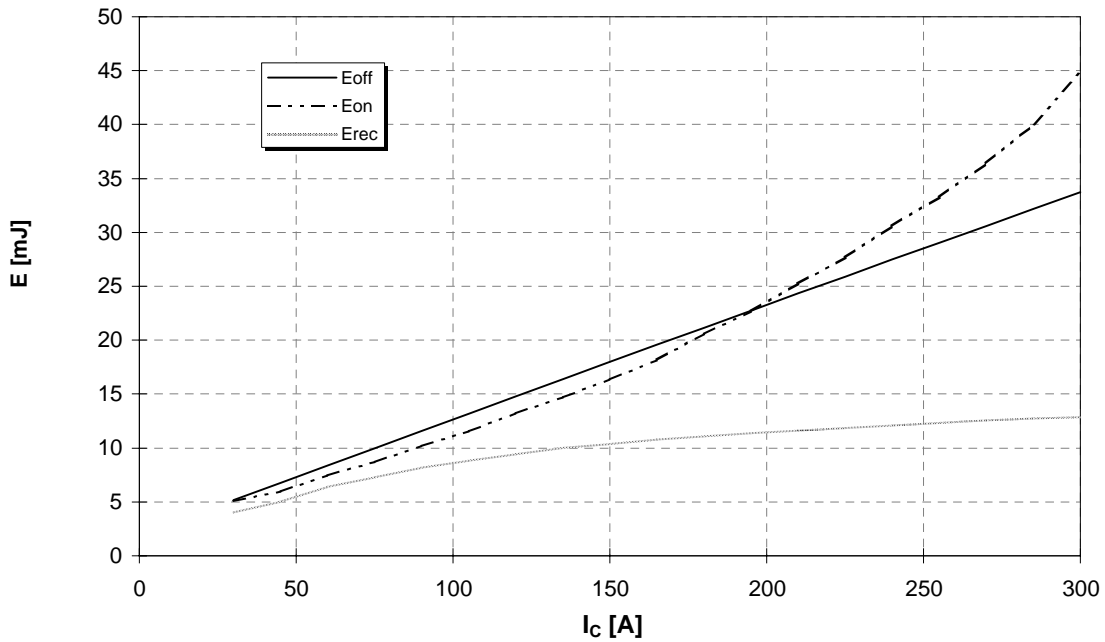

**Schaltverluste (typisch)  $E_{on} = f(R_G)$ ,  $E_{off} = f(R_G)$ ,  $E_{rec} = f(R_G)$**   
**Switching losses (typical)  $V_{GE}=15V$ ,  $I_C = 150A$ ,  $V_{CE} = 600V$ ,  $T_J = 125^\circ C$**

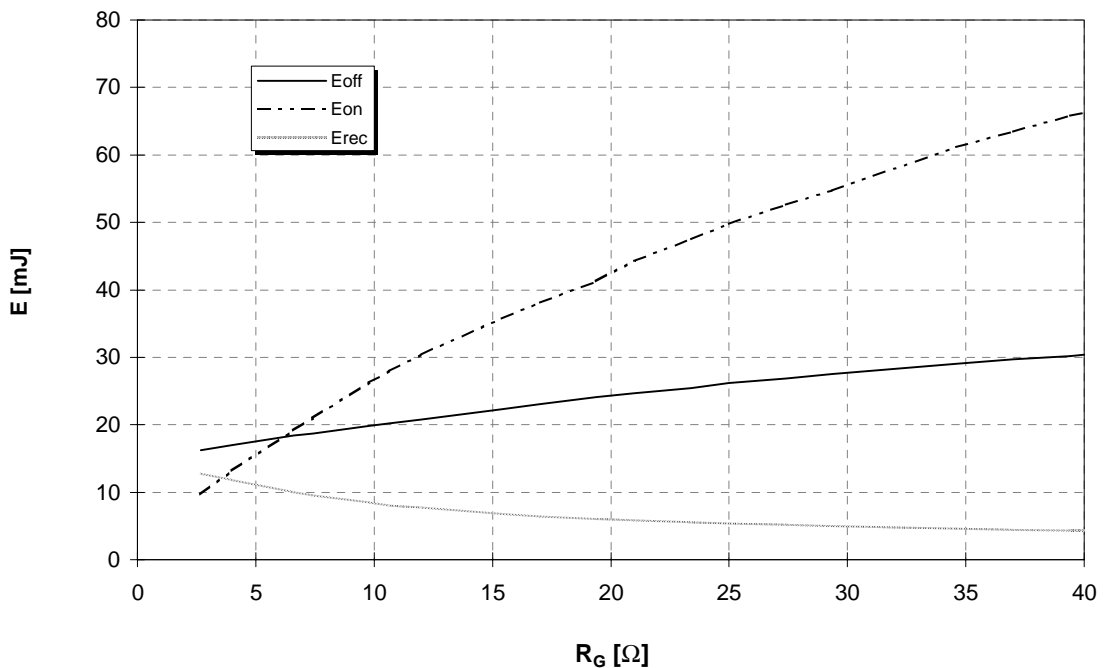



**vorläufige Daten**  
**preliminary data**

**Transienter Wärmewiderstand**  
**Transient thermal impedance**

$$Z_{thJC} = f(t)$$

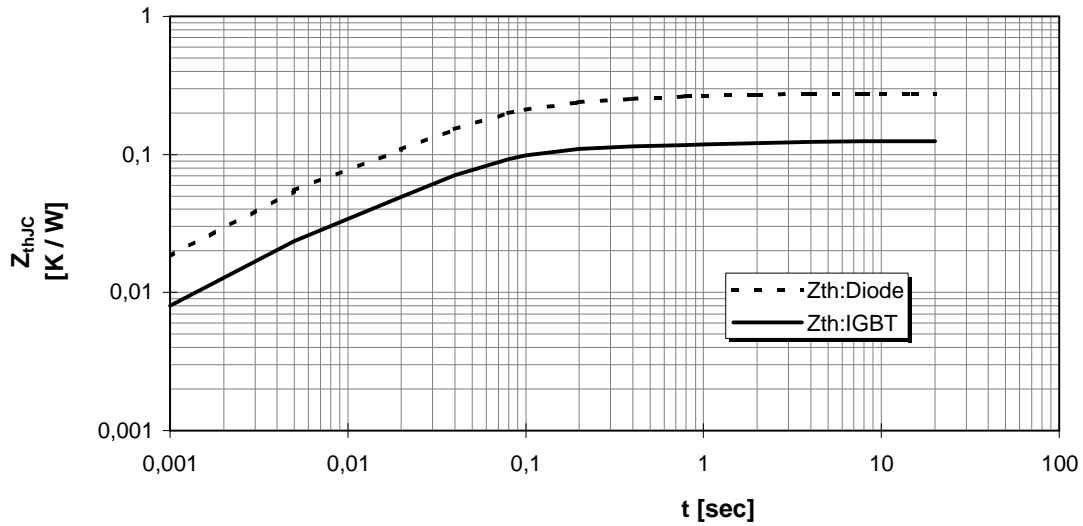

i	1	2	3	4
$r_i$ [K/kW] : IGBT	13,98	42,32	55,14	13,57
$\tau_i$ [sec] : IGBT	0,002	0,03	0,066	1,655
$r_i$ [K/kW] : Diode	35,99	95,32	104,00	39,70
$\tau_i$ [sec] : Diode	0,002	0,03	0,072	0,682

**Sicherer Arbeitsbereich (RBSOA)**

**Reverse bias safe operation area (RBSOA)**

$V_{GE} = 15V, R_g = 5,6 \text{ Ohm}, T_{vj} = 125^\circ C$

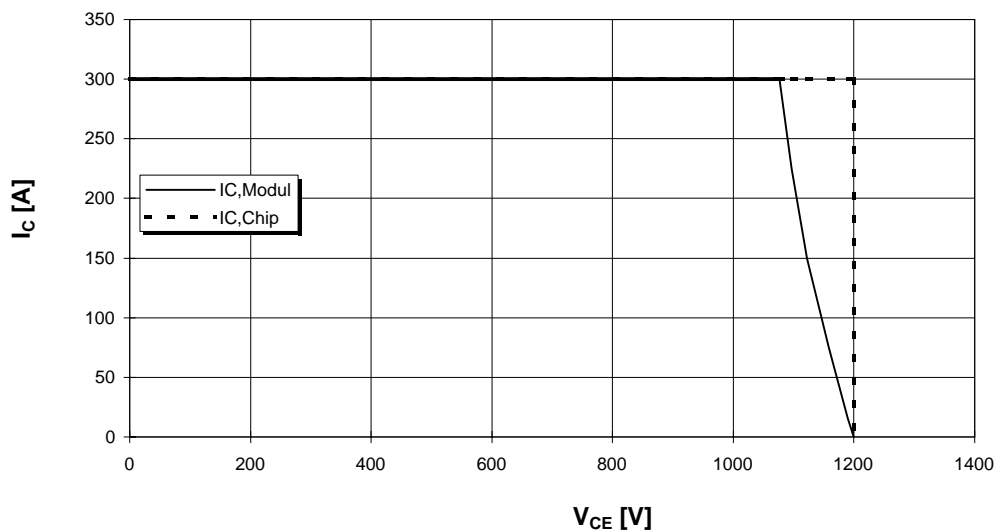



vorläufige Daten  
preliminary data

# Econo 3 Tripack

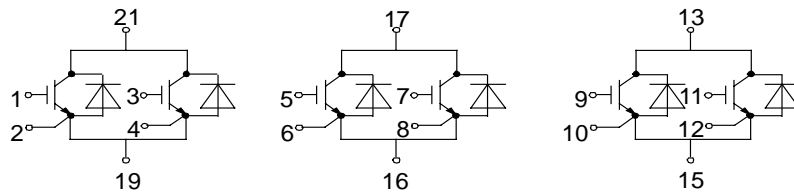
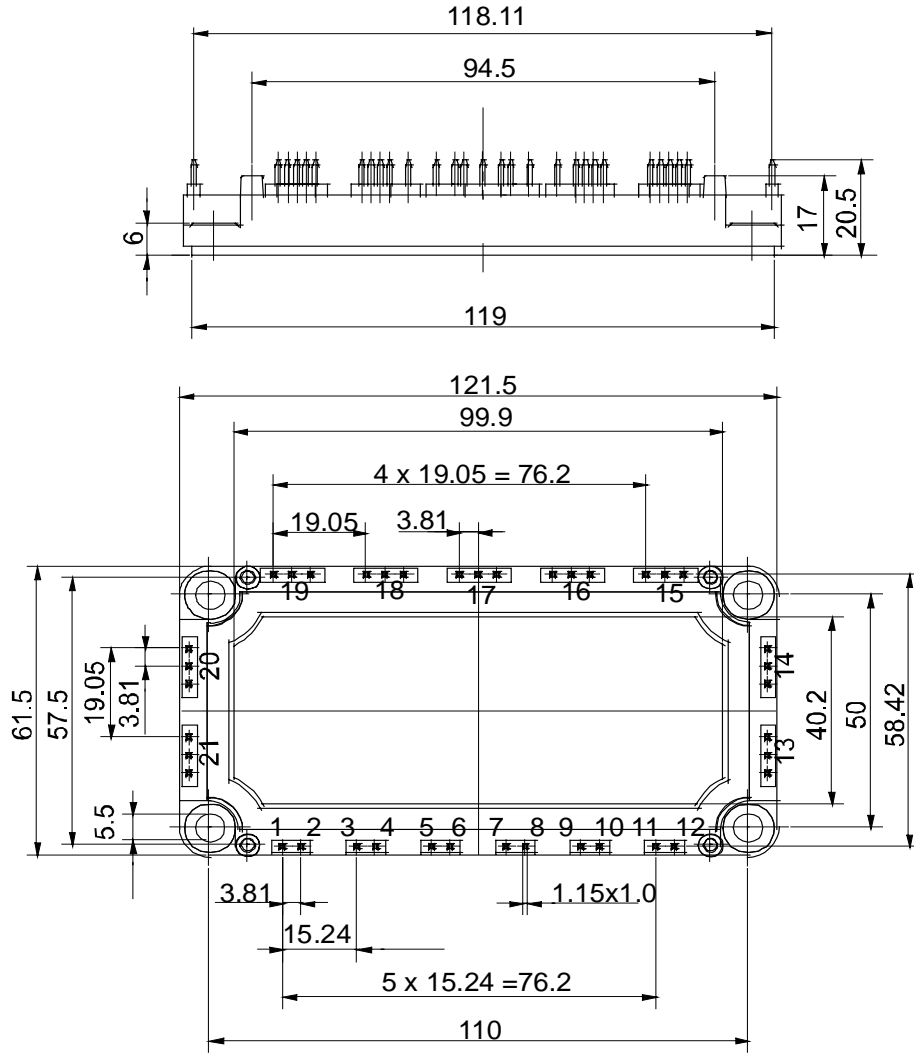

IS9