

## TL07xx Low-Noise FET-Input Operational Amplifiers

### 1 Features

- High slew rate: 20 V/μs (TL07xH, typ)
- Low offset voltage: 1 mV (TL07xH, typ)
- Low offset voltage drift: 2 μV/°C
- Low power consumption: 940 μA/ch (TL07xH, typ)
- Wide common-mode and differential voltage ranges
  - Common-mode input voltage range includes  $V_{CC+}$
- Low input bias and offset currents
- Low noise:  
 $V_n = 18 \text{ nV}/\sqrt{\text{Hz}}$  (typ) at  $f = 1 \text{ kHz}$
- Output short-circuit protection
- Low total harmonic distortion: 0.003% (typ)
- Wide supply voltage:  
 $\pm 2.25 \text{ V}$  to  $\pm 20 \text{ V}$ , 4.5 V to 40 V

### 2 Applications

- [Solar energy: string and central inverter](#)
- [Motor drives: AC and servo drive control and power stage modules](#)
- [Single phase online UPS](#)
- [Three phase UPS](#)
- [Pro audio mixers](#)
- [Battery test equipment](#)

### 3 Description

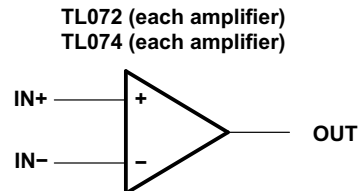
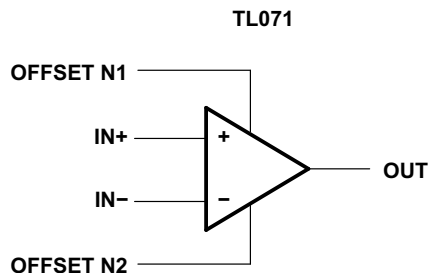
The TL07xH (TL071H, TL072H, and TL074H) family of devices are the next-generation versions of the industry-standard TL07x (TL071, TL072, and TL074) devices. These devices provide outstanding value for cost-sensitive applications, with features including low offset (1 mV, typical), high slew rate (20 V/μs), and common-mode input to the positive supply. High ESD

(1.5 kV, HBM), integrated EMI and RF filters, and operation across the full  $-40^\circ\text{C}$  to  $125^\circ\text{C}$  enable the TL07xH devices to be used in the most rugged and demanding applications.

#### Device Information

PART NUMBER <sup>(1)</sup>	PACKAGE	BODY SIZE (NOM)
TL071x	PDIP (8)	9.59 mm × 6.35 mm
	SC70 (5)	2.00 mm × 1.25 mm
	SO (8)	6.20 mm × 5.30 mm
	SOIC (8)	4.90 mm × 3.90 mm
	SOT-23 (5)	1.60 mm × 1.20 mm
TL072x	PDIP (8)	9.59 mm × 6.35 mm
	SO (8)	6.20 mm × 5.30 mm
	SOIC (8)	4.90 mm × 3.90 mm
	SOT-23 (8)	2.90 mm × 1.60 mm
	TSSOP (8)	4.40 mm × 3.00 mm
TL072M	CDIP (8)	9.59 mm × 6.67 mm
	CFP (10)	6.12 mm × 3.56 mm
	LCCC (20)	8.89 mm × 8.89 mm
TL074x	PDIP (14)	19.30 mm × 6.35 mm
	SO (14)	10.30 mm × 5.30 mm
	SOIC (14)	8.65 mm × 3.91 mm
	SOT-23 (14)	4.20 mm × 2.00 mm
	SSOP (14)	6.20 mm × 5.30 mm
TL074M	CDIP (14)	19.56 mm × 6.92 mm
	CFP (14)	9.21 mm × 6.29 mm
	LCCC (20)	8.89 mm × 8.89 mm

(1) For all available packages, see the orderable addendum at the end of the data sheet.



Copyright © 2017, Texas Instruments Incorporated

#### Logic Symbols



## Table of Contents

<b>1 Features</b> .....	1	6.23 Electrical Characteristics: TL071M, TL072M.....	22
<b>2 Applications</b> .....	1	6.24 Electrical Characteristics: TL074M.....	23
<b>3 Description</b> .....	1	6.25 Switching Characteristics: TL07xM.....	24
<b>4 Revision History</b> .....	2	6.26 Switching Characteristics: TL07xC, TL07xAC, TL07xBC, TL07xI.....	24
<b>5 Pin Configuration and Functions</b> .....	4	6.27 Electrical Characteristics, TL07xM.....	25
<b>6 Specifications</b> .....	10	6.28 Switching Characteristics.....	25
6.1 Absolute Maximum Ratings: TL07xH .....	10	6.29 Typical Characteristics: TL07xH.....	26
6.2 Absolute Maximum Ratings: All Devices Except TL07xH.....	10	6.30 Typical Characteristics: All Devices Except TL07xH.....	33
6.3 ESD Ratings: TL07xH .....	10	<b>7 Parameter Measurement Information</b> .....	37
6.4 ESD Ratings: All Devices Except TL07xH.....	11	<b>8 Detailed Description</b> .....	38
6.5 Recommended Operating Conditions: TL07xH .....	11	8.1 Overview.....	38
6.6 Recommended Operating Conditions: All Devices Except TL07xH.....	11	8.2 Functional Block Diagram.....	38
6.7 Thermal Information for Single Channel: TL071H .....	11	8.3 Feature Description.....	39
6.8 Thermal Information: TL071x.....	12	8.4 Device Functional Modes.....	39
6.9 Thermal Information for Dual Channel: TL072H .....	12	<b>9 Application and Implementation</b> .....	40
6.10 Thermal Information: TL072x.....	12	9.1 Application Information.....	40
6.11 Thermal Information: TL072x (cont.).....	13	9.2 Typical Application.....	40
6.12 Thermal Information for Quad Channel: TL074H .....	13	9.3 Unity Gain Buffer.....	41
6.13 Thermal Information: TL074x.....	13	9.4 System Examples.....	42
6.14 Thermal Information: TL074x (cont.).....	14	<b>10 Power Supply Recommendations</b> .....	43
6.15 Thermal Information: TL074x (cont.).....	14	<b>11 Layout</b> .....	43
6.16 Thermal Information.....	14	11.1 Layout Guidelines.....	43
6.17 Electrical Characteristics: TL07xH .....	15	11.2 Layout Example.....	44
6.18 Electrical Characteristics: TL071C, TL072C, TL074C.....	17	<b>12 Device and Documentation Support</b> .....	45
6.19 Electrical Characteristics: TL071AC, TL072AC, TL074AC.....	18	12.1 Related Links.....	45
6.20 Electrical Characteristics: TL071BC, TL072BC, TL074BC.....	19	12.2 Receiving Notification of Documentation Updates.....	45
6.21 Electrical Characteristics: TL071I, TL072I, TL074I.....	20	12.3 Support Resources.....	45
6.22 Electrical Characteristics, TL07xC, TL07xAC, TL07xBC, TL07xI.....	21	12.4 Trademarks.....	45
		12.5 Electrostatic Discharge Caution.....	45
		12.6 Glossary.....	45
		<b>13 Mechanical, Packaging, and Orderable Information</b> .....	45

## 4 Revision History

NOTE: Page numbers for previous revisions may differ from page numbers in the current version.

<b>Changes from Revision O (October 2020) to Revision P (November 2020)</b>	<b>Page</b>
• Added SOIC and TSSOP package thermal information in <i>Thermal Information for Quad Channel: TL074H</i> section .....	13
• Added <i>Typical Characteristics: TL07xH</i> section in <i>Specifications</i> section.....	26

<b>Changes from Revision N (July 2017) to Revision O (October 2020)</b>	<b>Page</b>
• Updated the numbering format for tables, figures, and cross-references throughout the document.....	1
• Features of TL07xH added to the <i>Features</i> section.....	1
• Added link to applications in the <i>Applications</i> section.....	1
• Added TL07xH in the <i>Description</i> section.....	1
• Added TL07xH device in the <i>Device Information</i> section.....	1
• Added SOT-23 (14), VSSOP (8), SOT-23 (8), SC70 (5), and SOT-23 (5) packages to the <i>Device Information</i> section.....	1
• Added TSSOP, VSSOP and DDF packages to TL072x in <i>Pin Configuration and Functions</i> section.....	4

• Added DYY package to TL074x in <i>Pin Configuration and Functions</i> section.....	4
• Removed Table of Graphs from the <i>Typical Characteristics</i> section.....	33
• Deleted reference to obsolete documentation in <i>Layout Guidelines</i> section.....	43
• Removed <i>Related Documentation</i> section.....	45

**Changes from Revision M (February 2014) to Revision N (July 2017) Page**

• Updated data sheet text to latest documentation and translation standards.....	1
• Added TL072M and TL074M devices to data sheet .....	1
• Rewrote text in <i>Description</i> section .....	1
• Changed TL07x 8-pin PDIP package to 8-pin CDIP package in <i>Device Information</i> table .....	1
• Deleted 20-pin LCCC package from <i>Device Information</i> table .....	1
• Added 2017 copyright statement to front page schematic.....	1
• Deleted TL071x FK (LCCC) pinout drawing and pinout table in <i>Pin Configurations and Functions</i> section .....	4
• Updated pinout diagrams and pinout tables in <i>Pin Configurations and Functions</i> section .....	4
• Deleted differential input voltage parameter from <i>Absolute Maximum Ratings</i> table .....	10
• Deleted table notes from <i>Absolute Maximum Ratings</i> table .....	10
• Added new table note to <i>Absolute Maximum Ratings</i> table .....	10
• Changed minimum supply voltage value from –18 V to –0.3 V in <i>Absolute Maximum Ratings</i> table.....	10
• Changed maximum supply voltage from 18 V to 36 V in <i>Absolute Maximum Ratings</i> table.....	10
• Changed minimum input voltage value from –15 V to $V_{CC-} - 0.3$ V in <i>Absolute Maximum Ratings</i> table.....	10
• Changed maximum input voltage from 15 V to $V_{CC+} + 36$ V in <i>Absolute Maximum Ratings</i> table.....	10
• Added input clamp current parameter to <i>Absolute Maximum Ratings</i> table .....	10
• Changed common-mode voltage maximum value from $V_{CC+} - 4$ V to $V_{CC+}$ in the <i>Recommended Operating Conditions</i> table.....	11
• Changed devices in <i>Recommended Operating Conditions</i> table from TL07xA and TL07xB to TL07xAC and TL07xBC .....	11
• Added TL07xl operating free-air temperature minimum value of –40°C to <i>Recommended Operating Conditions</i> table .....	11
• Added U (CFP) package thermal values to <i>Thermal Information: TL072x (cont.)</i> table.....	13
• Added W (CFP) package thermal values to <i>Thermal Information: TL074x (cont.)</i> table.....	14
• Added <a href="#">Figure 6-59</a> to <i>Typical Characteristics</i> section.....	33
• Added second <i>Typical Application</i> section application curves .....	41
• Reformatted document references in <i>Layout Guidelines</i> section .....	43

**Changes from Revision L (February 2014) to Revision M (February 2014) Page**

• Added <i>Device Information</i> table, <i>Pin Configuration and Functions</i> section, <i>ESD Ratings</i> table, <i>Feature Description</i> section, <i>Device Functional Modes, Application and Implementation</i> section, <i>Power Supply Recommendations</i> section, <i>Layout</i> section.....	1
--	---

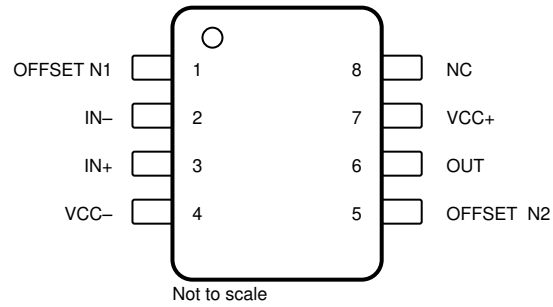
**Changes from Revision K (January 2014) to Revision L (February 2014) Page**

• Moved $T_{stg}$ to <i>Handling Ratings</i> table .....	11
--	----

**Changes from Revision J (March 2005) to Revision K (January 2014) Page**

• Updated document to new TI datasheet format - no specification changes.....	1
---	---

## 5 Pin Configuration and Functions

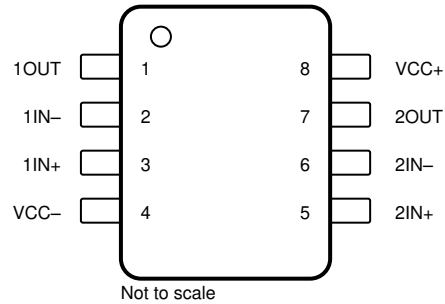


NC- no internal connection

**Figure 5-1. TL071x D, P, and PS Package  
 8-Pin SOIC, PDIP, and SO  
 Top View**

**Table 5-1. Pin Functions: TL071x**

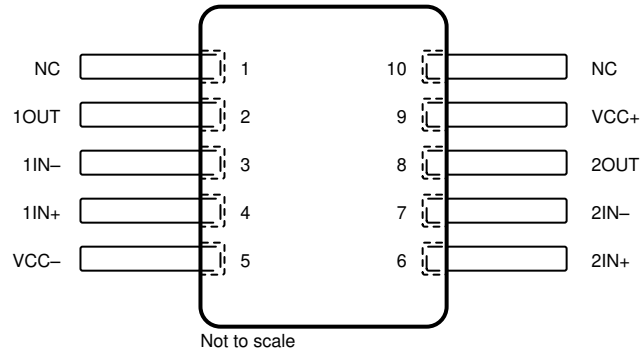
PIN		I/O	DESCRIPTION
NAME	NO.		
IN-	2	I	Inverting input
IN+	3	I	Noninverting input
NC	8	—	Do not connect
OFFSET N1	1	—	Input offset adjustment
OFFSET N2	5	—	Input offset adjustment
OUT	6	O	Output
VCC-	4	—	Power supply
VCC+	7	—	Power supply



**Figure 5-2. TL072x D, DDF, DGK, JG, P, PS, and PW Package  
8-Pin SOIC, SOT-23 (8), VSSOP, CDIP, PDIP, SO, and TSSOP  
Top View**

**Table 5-2. Pin Functions: TL072x**

PIN		I/O	DESCRIPTION
NAME	NO.		
1IN-	2	I	Inverting input
1IN+	3	I	Noninverting input
1OUT	1	O	Output
2IN-	6	I	Inverting input
2IN+	5	I	Noninverting input
2OUT	7	O	Output
VCC-	4	—	Power supply
VCC+	8	—	Power supply

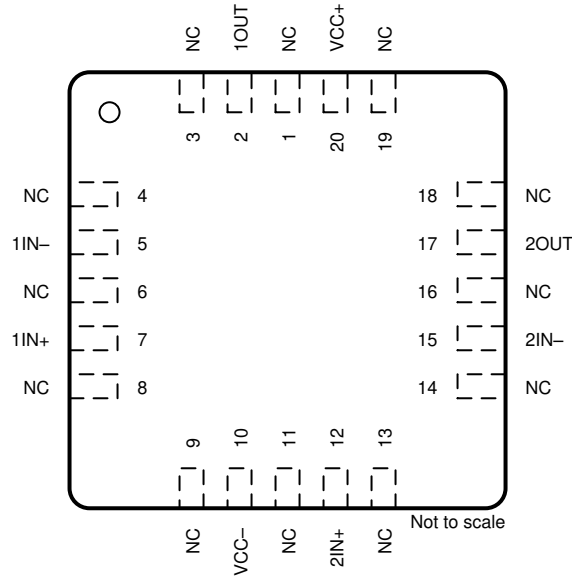


NC- no internal connection

**Figure 5-3. TL072x U Package  
10-Pin CFP  
Top View**

**Table 5-3. Pin Functions: TL072x**

PIN		I/O	DESCRIPTION
NAME	NO.		
1IN-	3	I	Inverting input
1IN+	4	I	Noninverting input
1OUT	2	O	Output
2IN-	7	I	Inverting input
2IN+	6	I	Noninverting input
2OUT	8	O	Output
NC	1, 10	—	Do not connect
VCC-	5	—	Power supply
VCC+	9	—	Power supply

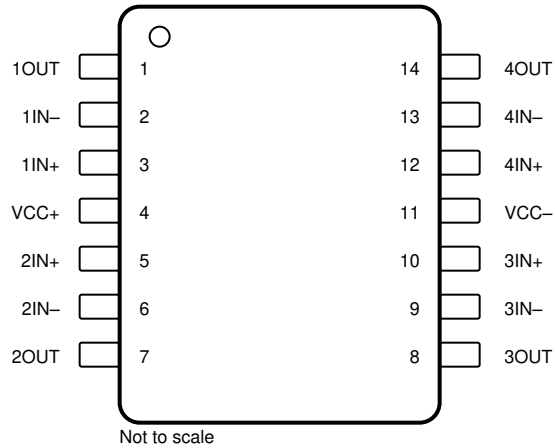


NC- no internal connection

**Figure 5-4. TL072 FK Package  
20-Pin LCCC  
Top View**

**Table 5-4. Pin Functions: TL072x**

PIN		I/O	DESCRIPTION
NAME	NO.		
1IN-	5	I	Inverting input
1IN+	7	I	Noninverting input
1OUT	2	O	Output
2IN-	15	I	Inverting input
2IN+	12	I	Noninverting input
2OUT	17	O	Output
NC	1, 3, 4, 6, 8, 9, 11, 13, 14, 16, 18, 19	—	Do not connect
VCC-	10	—	Power supply
VCC+	20	—	Power supply

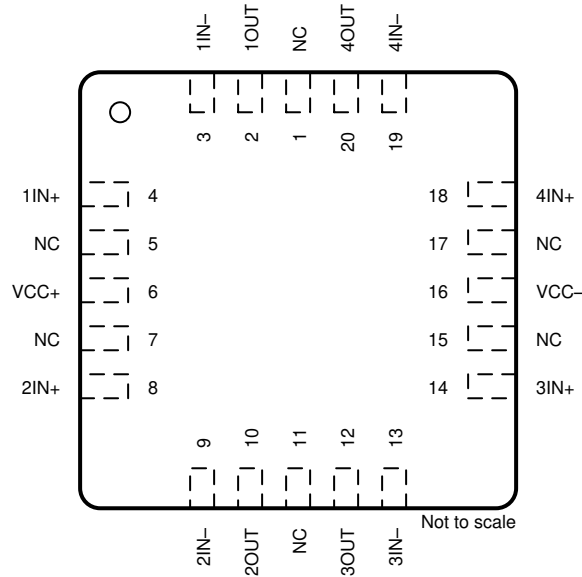


**Figure 5-5. TL074x D, N, NS, PW, J, DYY, and W Packages  
14-Pin SOIC, PDIP, SO, TSSOP, CDIP, SOT-23 (14), and CFP  
Top View**

**Table 5-5. Pin Functions: TL074x**

PIN		I/O	DESCRIPTION
NAME	NO.		
1IN-	2	I	Inverting input
1IN+	3	I	Noninverting input
1OUT	1	O	Output
2IN-	6	I	Inverting input
2IN+	5	I	Noninverting input
2OUT	7	O	Output
3IN-	9	I	Inverting input
3IN+	10	I	Noninverting input
3OUT	8	O	Output
4IN-	13	I	Inverting input
4IN+	12	I	Noninverting input
4OUT	14	O	Output
V <sub>CC-</sub>	11	—	Power supply
V <sub>CC+</sub>	4	—	Power supply





NC- no internal connection

**Figure 5-6. TL074 FK Package  
20-Pin LCCC  
Top View**

**Table 5-6. Pin Functions: TL074x**

PIN		I/O	DESCRIPTION
NAME	NO.		
1IN-	3	I	Inverting input
1IN+	4	I	Noninverting input
1OUT	2	O	Output
2IN-	9	I	Inverting input
2IN+	8	I	Noninverting input
2OUT	10	O	Output
3IN-	13	I	Inverting input
3IN+	14	I	Noninverting input
3OUT	12	O	Output
4IN-	19	I	Inverting input
4IN+	18	I	Noninverting input
4OUT	20	O	Output
NC	1, 5, 7, 11, 15, 17	—	Do not connect
VCC-	16	—	Power supply
VCC+	6	—	Power supply

## 6 Specifications

### 6.1 Absolute Maximum Ratings: TL07xH

over operating ambient temperature range (unless otherwise noted) <sup>(1)</sup>

		MIN	MAX	UNIT
Supply voltage, $V_S = (V_{CC+}) - (V_{CC-})$		0	42	V
Signal input pins	Common-mode voltage <sup>(3)</sup>	$(V_{CC-}) - 0.5$	$(V_{CC+}) + 0.5$	V
	Differential voltage <sup>(3)</sup>		$V_S + 0.2$	V
	Current <sup>(3)</sup>	-10	10	mA
Output short-circuit <sup>(2)</sup>		Continuous		
Operating ambient temperature, $T_A$		-55	150	°C
Junction temperature, $T_J$			150	°C
Storage temperature, $T_{stg}$		-65	150	°C

- (1) Stresses beyond those listed under *Absolute Maximum Ratings* may cause permanent damage to the device. These are stress ratings only, which do not imply functional operation of the device at these or any other conditions beyond those indicated under *Recommended Operating Conditions*. Exposure to absolute-maximum-rated conditions for extended periods may affect device reliability.
- (2) Short-circuit to ground, one amplifier per package.
- (3) Input pins are diode-clamped to the power-supply rails. Input signals that may swing more than 0.5 V beyond the supply rails must be current limited to 10 mA or less.

### 6.2 Absolute Maximum Ratings: All Devices Except TL07xH

over operating free-air temperature range (unless otherwise noted) <sup>(1)</sup>

		MIN	MAX	UNIT
$V_{CC+} - V_{CC-}$	Supply voltage	-0.3	36	V
$V_I$	Input voltage <sup>(3)</sup>	$V_{CC-} - 0.3$	$V_{CC-} + 36$	V
$I_{IK}$	Input clamp current		-50	mA
	Duration of output short circuit <sup>(2)</sup>	Unlimited		
$T_J$	Operating virtual junction temperature		150	°C
	Case temperature for 60 seconds - FK package		260	°C
	Lead temperature 1.8 mm (1/16 inch) from case for 10 seconds		300	°C
$T_{stg}$	Storage temperature	-65	150	°C

- (1) Stresses beyond those listed under *Absolute Maximum Ratings* may cause permanent damage to the device. These are stress ratings only, and functional operation of the device at these or any other conditions beyond those indicated under *Recommended Operating Conditions* is not implied. Exposure to absolute-maximum-rated conditions for extended periods may affect device reliability.
- (2) The output may be shorted to ground or to either supply. Temperature and supply voltages must be limited to ensure that the dissipation rating is not exceeded.
- (3) Differential voltage only limited by input voltage.

### 6.3 ESD Ratings: TL07xH

		VALUE	UNIT
$V_{(ESD)}$	Electrostatic discharge	Human body model (HBM), per ANSI/ESDA/JEDEC JS-001 <sup>(1)</sup>	±1500
		Charged device model (CDM), per JEDEC specification JESD22-C101 <sup>(2)</sup>	±1000

- (1) JEDEC document JEP155 states that 500-V HBM allows safe manufacturing with a standard ESD control process.
- (2) JEDEC document JEP157 states that 250-V CDM allows safe manufacturing with a standard ESD control process.

## 6.4 ESD Ratings: All Devices Except TL07xH

		VALUE	UNIT
V <sub>(ESD)</sub>	Electrostatic discharge	Human body model (HBM), per ANSI/ESDA/JEDEC JS-001 <sup>(1)</sup>	±2000
		Charged-device model (CDM), per JEDEC specification JESD22-C101 <sup>(2)</sup>	±1000

- (1) JEDEC document JEP155 states that 500-V HBM allows safe manufacturing with a standard ESD control process.  
(2) JEDEC document JEP157 states that 250-V CDM allows safe manufacturing with a standard ESD control process.

## 6.5 Recommended Operating Conditions: TL07xH

over operating ambient temperature range (unless otherwise noted)

		MIN	MAX	UNIT
V <sub>S</sub>	Supply voltage, (V <sub>CC+</sub> ) – (V <sub>CC-</sub> )	4.5	40	V
V <sub>I</sub>	Input voltage range	(V <sub>CC-</sub> ) + 2	(V <sub>CC+</sub> ) + 0.1	V
T <sub>A</sub>	Specified temperature	–40	125	°C

## 6.6 Recommended Operating Conditions: All Devices Except TL07xH

over operating free-air temperature range (unless otherwise noted)

		MIN	MAX	UNIT
V <sub>CC+</sub>	Supply voltage <sup>(1)</sup>	5	15	V
V <sub>CC-</sub>	Supply voltage <sup>(1)</sup>	–5	–15	V
V <sub>CM</sub>	Common-mode voltage	V <sub>CC-</sub> + 4	V <sub>CC+</sub>	V
T <sub>A</sub>	Operating free-air temperature	TL07xM	–55	125
		TL08xQ	–40	125
		TL07xI	–40	85
		TL07xAC, TL07xBC, TL07xC	0	70

- (1) V<sub>CC+</sub> and V<sub>CC-</sub> are not required to be of equal magnitude, provided that the total V<sub>CC</sub> (V<sub>CC+</sub> – V<sub>CC-</sub>) is between 10 V and 30 V.

## 6.7 Thermal Information for Single Channel: TL071H

THERMAL METRIC <sup>(1)</sup>		TL071H		UNIT
		D <sup>(2)</sup> (SOIC)	DBV <sup>(2)</sup> (SOT-23)	
		8 PINS	5 PINS	
R <sub>θJA</sub>	Junction-to-ambient thermal resistance	TBD	TBD	°C/W
R <sub>θJC(top)</sub>	Junction-to-case (top) thermal resistance	TBD	TBD	°C/W
R <sub>θJB</sub>	Junction-to-board thermal resistance	TBD	TBD	°C/W
ψ <sub>JT</sub>	Junction-to-top characterization parameter	TBD	TBD	°C/W
ψ <sub>JB</sub>	Junction-to-board characterization parameter	TBD	TBD	°C/W
R <sub>θJC(bot)</sub>	Junction-to-case (bottom) thermal resistance	TBD	TBD	°C/W

- (1) For more information about traditional and new thermal metrics, see the *Semiconductor and IC Package Thermal Metrics* application report, [SPRA953](#).  
(2) This package option is preview for TL071H.

## 6.8 Thermal Information: TL071x

THERMAL METRIC <sup>(1)</sup>		TL071x			UNIT
		D (SOIC)	P (PDIP)	PS (SO)	
		8 PINS	8 PINS	8 PINS	
R <sub>θJA</sub>	Junction-to-ambient thermal resistance	97	85	95	°C/W
R <sub>θJC(top)</sub>	Junction-to-case (top) thermal resistance	—	—	—	°C/W

- (1) For more information about traditional and new thermal metrics, see the [Semiconductor and IC Package Thermal Metrics](#) application report.

## 6.9 Thermal Information for Dual Channel: TL072H

THERMAL METRIC <sup>(1)</sup>		TL072H			UNIT
		D <sup>(2)</sup> (SOIC)	DGK <sup>(2)</sup> (VSSOP)	PW <sup>(2)</sup> (TSSOP)	
		8 PINS	8 PINS	8 PINS	
R <sub>θJA</sub>	Junction-to-ambient thermal resistance	TBD	TBD	TBD	°C/W
R <sub>θJC(top)</sub>	Junction-to-case (top) thermal resistance	TBD	TBD	TBD	°C/W
R <sub>θJB</sub>	Junction-to-board thermal resistance	TBD	TBD	TBD	°C/W
ψ <sub>JT</sub>	Junction-to-top characterization parameter	TBD	TBD	TBD	°C/W
ψ <sub>JB</sub>	Junction-to-board characterization parameter	TBD	TBD	TBD	°C/W
R <sub>θJC(bot)</sub>	Junction-to-case (bottom) thermal resistance	TBD	TBD	TBD	°C/W

- (1) For more information about traditional and new thermal metrics, see the [Semiconductor and IC Package Thermal Metrics](#) application report, [SPRA953](#).  
 (2) This package option is preview for TL072H.

## 6.10 Thermal Information: TL072x

THERMAL METRIC <sup>(1)</sup>		TL072x				UNIT
		D (SOIC)	JG (CDIP)	P (PDIP)	PS (SO)	
		8 PINS	8 PINS	8 PINS	8 PINS	
R <sub>θJA</sub>	Junction-to-ambient thermal resistance	97	—	85	95	°C/W
R <sub>θJC(top)</sub>	Junction-to-case (top) thermal resistance	—	15.05	—	—	°C/W

- (1) For more information about traditional and new thermal metrics, see the [Semiconductor and IC Package Thermal Metrics](#) application report.

### 6.11 Thermal Information: TL072x (cont.)

THERMAL METRIC <sup>(1)</sup>		TL072x			UNIT
		PW (TSSOP)	U (CFP)	FK (LCCC)	
		8 PINS	10 PINS	20 PINS	
R <sub>θJA</sub>	Junction-to-ambient thermal resistance	150	169.8	—	°C/W
R <sub>θJC(top)</sub>	Junction-to-case (top) thermal resistance	—	62.1	5.61	°C/W
R <sub>θJB</sub>	Junction-to-board thermal resistance	—	176.2	—	°C/W
ψ <sub>JT</sub>	Junction-to-top characterization parameter	—	48.4	—	°C/W
ψ <sub>JB</sub>	Junction-to-board characterization parameter	—	144.1	—	°C/W
R <sub>θJC(bot)</sub>	Junction-to-case (bottom) thermal resistance	—	5.4	—	°C/W

(1) For more information about traditional and new thermal metrics, see the [Semiconductor and IC Package Thermal Metrics](#) application report.

### 6.12 Thermal Information for Quad Channel: TL074H

THERMAL METRIC <sup>(1)</sup>		TL074H		UNIT
		D (SOIC)	PW (TSSOP)	
		14 PINS	14 PINS	
R <sub>θJA</sub>	Junction-to-ambient thermal resistance	114.2	134.4	°C/W
R <sub>θJC(top)</sub>	Junction-to-case (top) thermal resistance	70.3	62.6	°C/W
R <sub>θJB</sub>	Junction-to-board thermal resistance	70.2	77.6	°C/W
ψ <sub>JT</sub>	Junction-to-top characterization parameter	28.8	13.0	°C/W
ψ <sub>JB</sub>	Junction-to-board characterization parameter	69.8	77.0	°C/W
R <sub>θJC(bot)</sub>	Junction-to-case (bottom) thermal resistance	N/A	N/A	°C/W

(1) For more information about traditional and new thermal metrics, see the [Semiconductor and IC Package Thermal Metrics](#) application report, [SPRA953](#).

### 6.13 Thermal Information: TL074x

THERMAL METRIC <sup>(1)</sup>		TL074x			UNIT
		D (SOIC)	N (PDIP)	NS (SO)	
		14 PINS	14 PINS	14 PINS	
R <sub>θJA</sub>	Junction-to-ambient thermal resistance	86	80	76	°C/W
R <sub>θJC(top)</sub>	Junction-to-case (top) thermal resistance	—	—	—	°C/W

(1) For more information about traditional and new thermal metrics, see the [Semiconductor and IC Package Thermal Metrics](#) application report.

### 6.14 Thermal Information: TL074x (cont).

THERMAL METRIC <sup>(1)</sup>		TL074x			UNIT
		J (CDIP)	PW (TSSOP)	W (CFP)	
		14 PINS	14 PINS	14 PINS	
R <sub>θJA</sub>	Junction-to-ambient thermal resistance	—	113	128.8	°C/W
R <sub>θJC(top)</sub>	Junction-to-case (top) thermal resistance	14.5	—	56.1	°C/W
R <sub>θJB</sub>	Junction-to-board thermal resistance	—	—	127.6	°C/W
ψ <sub>JT</sub>	Junction-to-top characterization parameter	—	—	29	°C/W
ψ <sub>JB</sub>	Junction-to-board characterization parameter	—	—	106.1	°C/W
R <sub>θJC(bot)</sub>	Junction-to-case (bottom) thermal resistance	—	—	0.5	°C/W

(1) For more information about traditional and new thermal metrics, see the [Semiconductor and IC Package Thermal Metrics](#) application report.

### 6.15 Thermal Information: TL074x (cont).

THERMAL METRIC <sup>(1)</sup>		TL074x		UNIT
		FK (LCCC)		
		20 PINS		
R <sub>θJA</sub>	Junction-to-ambient thermal resistance	—		°C/W
R <sub>θJC(top)</sub>	Junction-to-case (top) thermal resistance	5.61		°C/W

(1) For more information about traditional and new thermal metrics, see the [Semiconductor and IC Package Thermal Metrics](#) application report.

### 6.16 Thermal Information

THERMAL METRIC <sup>(1)</sup>		TL071/TL072/TL074										UNIT	
		D (SOIC)		FK (LCCC)	J (CDIP)		N (PDIP)		NS (SO)		PW (TSSOP)		
		8 PINS	14 PINS	20 PINS	8 PINS	14 PINS	8 PINS	14 PINS	8 PINS	14 PINS	8 PINS		14 PINS
R <sub>θJA</sub>	Junction-to-ambient thermal resistance	97	86	—	—	—	85	80	95	76	150	113	°C/W
R <sub>θJC(top)</sub>	Junction-to-case (top) thermal resistance	—	—	5.61	15.05	14.5	—	—	—	—	—	—	°C/W

(1) For more information about traditional and new thermal metrics, see the [Semiconductor and IC Package Thermal Metrics](#) application report.

## 6.17 Electrical Characteristics: TL07xH

For  $V_S = (V_{CC+}) - (V_{CC-}) = 4.5 \text{ V to } 40 \text{ V}$  ( $\pm 2.25 \text{ V to } \pm 20 \text{ V}$ ) at  $T_A = 25^\circ\text{C}$ ,  $R_L = 10 \text{ k}\Omega$  connected to  $V_S / 2$ ,  $V_{CM} = V_S / 2$ , and  $V_{O\text{UT}} = V_S / 2$ , unless otherwise noted.

PARAMETER		TEST CONDITIONS		MIN	TYP	MAX	UNIT
<b>OFFSET VOLTAGE</b>							
$V_{OS}$	Input offset voltage		$T_A = -40^\circ\text{C to } 125^\circ\text{C}$		$\pm 1$	$\pm 4$	mV
						$\pm 5$	
$dV_{OS}/dT$	Input offset voltage drift		$T_A = -40^\circ\text{C to } 125^\circ\text{C}$		$\pm 2$		$\mu\text{V}/^\circ\text{C}$
PSRR	Input offset voltage versus power supply	$V_S = 5 \text{ V to } 40 \text{ V}$ , $V_{CM} = V_S / 2$	$T_A = -40^\circ\text{C to } 125^\circ\text{C}$		$\pm 1$	$\pm 10$	$\mu\text{V}/\text{V}$
	Channel separation	$f = 0 \text{ Hz}$			10		$\mu\text{V}/\text{V}$
<b>INPUT BIAS CURRENT</b>							
$I_B$	Input bias current		$T_A = -40^\circ\text{C to } 125^\circ\text{C}^{(1)}$		$\pm 1$	$\pm 120$	pA
						$\pm 5$	nA
$I_{OS}$	Input offset current		$T_A = -40^\circ\text{C to } 125^\circ\text{C}^{(1)}$		$\pm 0.5$	$\pm 120$	pA
						$\pm 5$	nA
<b>NOISE</b>							
$E_N$	Input voltage noise	$f = 0.1 \text{ Hz to } 10 \text{ Hz}$			9.2		$\mu\text{V}_{PP}$
					1.4		$\mu\text{V}_{RMS}$
$e_N$	Input voltage noise density	$f = 1 \text{ kHz}$			37		$\text{nV}/\sqrt{\text{Hz}}$
		$f = 10 \text{ kHz}$			21		
$i_N$	Input current noise	$f = 1 \text{ kHz}$			80		$\text{fA}/\sqrt{\text{Hz}}$
<b>INPUT VOLTAGE RANGE</b>							
$V_{CM}$	Common-mode voltage range			$(V_{CC-}) + 1.5$		$(V_{CC+})$	V
CMRR	Common-mode rejection ratio	$V_S = 40 \text{ V}$ , $(V_{CC-}) + 2.5 \text{ V} < V_{CM} < (V_{CC+}) - 1.5 \text{ V}$		100	105		dB
CMRR	Common-mode rejection ratio		$T_A = -40^\circ\text{C to } 125^\circ\text{C}$	95			dB
CMRR	Common-mode rejection ratio	$V_S = 40 \text{ V}$ , $(V_{CC-}) + 2.5 \text{ V} < V_{CM} < (V_{CC+})$		90	105		dB
CMRR	Common-mode rejection ratio		$T_A = -40^\circ\text{C to } 125^\circ\text{C}$	80			dB
<b>INPUT CAPACITANCE</b>							
$Z_{ID}$	Differential				$100 \parallel 2$		$\text{M}\Omega \parallel \text{pF}$
$Z_{ICM}$	Common-mode				$6 \parallel 1$		$\text{T}\Omega \parallel \text{pF}$
<b>OPEN-LOOP GAIN</b>							
$A_{OL}$	Open-loop voltage gain	$V_S = 40 \text{ V}$ , $V_{CM} = V_S / 2$ , $(V_{CC-}) + 0.3 \text{ V} < V_O < (V_{CC+}) - 0.3 \text{ V}$	$T_A = -40^\circ\text{C to } 125^\circ\text{C}$	118	125		dB
$A_{OL}$	Open-loop voltage gain	$V_S = 40 \text{ V}$ , $V_{CM} = V_S / 2$ , $R_L = 2 \text{ k}\Omega$ , $(V_{CC-}) + 1.2 \text{ V} < V_O < (V_{CC+}) - 1.2 \text{ V}$	$T_A = -40^\circ\text{C to } 125^\circ\text{C}$	115	120		dB
<b>FREQUENCY RESPONSE</b>							
GBW	Gain-bandwidth product				5.25		MHz
SR	Slew rate	$V_S = 40 \text{ V}$ , $G = +1$ , $C_L = 20 \text{ pF}$			20		$\text{V}/\mu\text{s}$

For  $V_S = (V_{CC+}) - (V_{CC-}) = 4.5 \text{ V to } 40 \text{ V}$  ( $\pm 2.25 \text{ V to } \pm 20 \text{ V}$ ) at  $T_A = 25^\circ\text{C}$ ,  $R_L = 10 \text{ k}\Omega$  connected to  $V_S / 2$ ,  $V_{CM} = V_S / 2$ , and  $V_{O UT} = V_S / 2$ , unless otherwise noted.

PARAMETER		TEST CONDITIONS	MIN	TYP	MAX	UNIT
$t_s$	Settling time	To 0.1%, $V_S = 40 \text{ V}$ , $V_{STEP} = 10 \text{ V}$ , $G = +1$ , $CL = 20 \text{ pF}$		0.63		$\mu\text{s}$
		To 0.1%, $V_S = 40 \text{ V}$ , $V_{STEP} = 2 \text{ V}$ , $G = +1$ , $CL = 20 \text{ pF}$		0.56		
		To 0.01%, $V_S = 40 \text{ V}$ , $V_{STEP} = 10 \text{ V}$ , $G = +1$ , $CL = 20 \text{ pF}$		0.91		
		To 0.01%, $V_S = 40 \text{ V}$ , $V_{STEP} = 2 \text{ V}$ , $G = +1$ , $CL = 20 \text{ pF}$		0.48		
	Phase margin	$G = +1$ , $R_L = 10\text{k}\Omega$ , $C_L = 20 \text{ pF}$		56		$^\circ$
	Overload recovery time	$V_{IN} \times \text{gain} > V_S$		300		ns
THD+N	Total harmonic distortion + noise	$V_S = 40 \text{ V}$ , $V_O = 6 V_{RMS}$ , $G = +1$ , $f = 1 \text{ kHz}$		0.00012		%
EMIRR	EMI rejection ratio	$f = 1 \text{ GHz}$		53		dB
<b>OUTPUT</b>						
	Voltage output swing from rail	Positive rail headroom	$V_S = 40 \text{ V}$ , $R_L = 10 \text{ k}\Omega$	115	210	mV
			$V_S = 40 \text{ V}$ , $R_L = 2 \text{ k}\Omega$	520	965	
		Negative rail headroom	$V_S = 40 \text{ V}$ , $R_L = 10 \text{ k}\Omega$	105	215	
			$V_S = 40 \text{ V}$ , $R_L = 2 \text{ k}\Omega$	500	1030	
$I_{SC}$	Short-circuit current			$\pm 26$		mA
$C_{LOAD}$	Capacitive load drive			300		pF
$Z_O$	Open-loop output impedance	$f = 1 \text{ MHz}$ , $I_O = 0 \text{ A}$		125		$\Omega$
<b>POWER SUPPLY</b>						
$I_Q$	Quiescent current per amplifier	$I_O = 0 \text{ A}$		937.5	1125	$\mu\text{A}$
			$T_A = -40^\circ\text{C to } 125^\circ\text{C}$		1130	
	Turn-On Time	At $T_A = 25^\circ\text{C}$ , $V_S = 40 \text{ V}$ , $V_S$ ramp rate $> 0.3 \text{ V}/\mu\text{s}$		60		$\mu\text{s}$

(1) Max  $I_B$  and  $I_{OS}$  data is specified based on characterization results.



## 6.18 Electrical Characteristics: TL071C, TL072C, TL074C

 $V_{CC\pm} = \pm 15\text{ V}$  (unless otherwise noted)

PARAMETER		TEST CONDITIONS <sup>(1)</sup> <sup>(2)</sup>		MIN	TYP	MAX	UNIT
$V_{IO}$	Input offset voltage	$V_O = 0$ $R_S = 50\ \Omega$	$T_A = 25^\circ\text{C}$		3	10	mV
			$T_A = \text{Full range}$			13	
$\alpha$	Temperature coefficient of input offset voltage	$V_O = 0$ $R_S = 50\ \Omega$	$T_A = \text{Full range}$		18		$\mu\text{V}/^\circ\text{C}$
$I_{IO}$	Input offset current	$V_O = 0$	$T_A = 25^\circ\text{C}$		5	100	pA
			$T_A = \text{Full range}$			10	nA
$I_{IB}$	Input bias current <sup>(3)</sup>	$V_O = 0$	$T_A = 25^\circ\text{C}$		65	200	pA
			$T_A = \text{Full range}$			7	nA
$V_{ICR}$	Common-mode input voltage range	$T_A = 25^\circ\text{C}$		$\pm 11$	–12 to 15		V
$V_{OM}$	Maximum peak output voltage swing	$R_L = 10\ \text{k}\Omega$ $R_L \geq 10\ \text{k}\Omega$ $R_L \geq 2\ \text{k}\Omega$	$T_A = 25^\circ\text{C}$		$\pm 12$	$\pm 13.5$	V
			$T_A = \text{Full range}$		$\pm 12$		
					$\pm 10$		
$A_{VD}$	Large-signal differential voltage amplification	$V_O = \pm 10\ \text{V}$ $R_L \geq 2\ \text{k}\Omega$	$T_A = 25^\circ\text{C}$		25	200	V/mV
			$T_A = \text{Full range}$		15		
$B_1$	Utility-gain bandwidth	$T_A = 25^\circ\text{C}$			3		MHz
$r_I$	Input resistance	$T_A = 25^\circ\text{C}$			$10^{12}$		$\Omega$
CMRR	Common-mode rejection ratio	$V_{IC} = V_{ICR(\text{min})}$ $V_O = 0$ $R_S = 50\ \Omega$	$T_A = 25^\circ\text{C}$		70	100	dB
$k_{SVR}$	Supply voltage rejection ratio ( $\Delta V_{CC\pm}/\Delta V_{IO}$ )	$V_{CC} = \pm 9\ \text{V}$ to $\pm 15\ \text{V}$ $V_O = 0$ $R_S = 50\ \Omega$	$T_A = 25^\circ\text{C}$		70	100	dB
$I_{CC}$	Supply current (each amplifier)	$V_O = 0$ ; no load		$T_A = 25^\circ\text{C}$	1.4	2.5	mA
$V_{O1} / V_{O2}$	Crosstalk attenuation	$A_{VD} = 100$		$T_A = 25^\circ\text{C}$		120	dB

- (1) All characteristics are measured under open-loop conditions with zero common-mode voltage, unless otherwise specified.
- (2) Full range is  $T_A = 0^\circ\text{C}$  to  $70^\circ\text{C}$ .
- (3) Input bias currents of an FET-input operational amplifier are normal junction reverse currents, which are temperature sensitive, as shown in [Figure 6-40](#). Pulse techniques must be used that maintain the junction temperature as close to the ambient temperature as possible.

## 6.19 Electrical Characteristics: TL071AC, TL072AC, TL074AC

$V_{CC\pm} = \pm 15\text{ V}$  (unless otherwise noted)

PARAMETER		TEST CONDITIONS <sup>(1)</sup> <sup>(2)</sup>		MIN	TYP	MAX	UNIT
$V_{IO}$	Input offset voltage	$V_O = 0$ $R_S = 50\ \Omega$	$T_A = 25^\circ\text{C}$	3	6	7.5	mV
			$T_A = \text{Full range}$				
$\alpha$	Temperature coefficient of input offset voltage	$V_O = 0$ $R_S = 50\ \Omega$	$T_A = \text{Full range}$		18		$\mu\text{V}/^\circ\text{C}$
$I_{IO}$	Input offset current	$V_O = 0$	$T_A = 25^\circ\text{C}$	5	100		pA
			$T_A = \text{Full range}$			2	nA
$I_{IB}$	Input bias current <sup>(3)</sup>	$V_O = 0$	$T_A = 25^\circ\text{C}$	65	200		pA
			$T_A = \text{Full range}$			7	nA
$V_{ICR}$	Common-mode input voltage range	$T_A = 25^\circ\text{C}$		$\pm 11$	–12 to 15		V
$V_{OM}$	Maximum peak output voltage swing	$R_L = 10\ \text{k}\Omega$ $R_L \geq 10\ \text{k}\Omega$ $R_L \geq 2\ \text{k}\Omega$	$T_A = 25^\circ\text{C}$	$\pm 12$	$\pm 13.5$		V
			$T_A = \text{Full range}$	$\pm 12$			
				$\pm 10$			
$A_{VD}$	Large-signal differential voltage amplification	$V_O = \pm 10\ \text{V}$ $R_L \geq 2\ \text{k}\Omega$	$T_A = 25^\circ\text{C}$	50	200		V/mV
			$T_A = \text{Full range}$	25			
$B_1$	Utility-gain bandwidth	$T_A = 25^\circ\text{C}$			3		MHz
$r_i$	Input resistance	$T_A = 25^\circ\text{C}$			$10^{12}$		$\Omega$
CMRR	Common-mode rejection ratio	$V_{IC} = V_{ICR(\text{min})}$ $V_O = 0$ $R_S = 50\ \Omega$	$T_A = 25^\circ\text{C}$	75	100		dB
$k_{SVR}$	Supply-voltage rejection ratio ( $\Delta V_{CC\pm} / \Delta V_{IO}$ )	$V_{CC} = \pm 9\ \text{V}$ to $\pm 15\ \text{V}$ $V_O = 0$ $R_S = 50\ \Omega$	$T_A = 25^\circ\text{C}$	80	100		dB
$I_{CC}$	Supply current (each amplifier)	$V_O = 0$ ; no load			1.4	2.5	mA
$V_{O1} / V_{O2}$	Crosstalk attenuation	$A_{VD} = 100$			120		dB

- (1) All characteristics are measured under open-loop conditions with zero common-mode voltage, unless otherwise specified.
- (2) Full range is  $T_A = 0^\circ\text{C}$  to  $70^\circ\text{C}$ .
- (3) Input bias currents of an FET-input operational amplifier are normal junction reverse currents, which are temperature sensitive, as shown in Figure 6-40. Pulse techniques must be used that maintain the junction temperature as close to the ambient temperature as possible.

## 6.20 Electrical Characteristics: TL071BC, TL072BC, TL074BC

 $V_{CC\pm} = \pm 15\text{ V}$  (unless otherwise noted)

PARAMETER		TEST CONDITIONS (1) (2)		MIN	TYP	MAX	UNIT
$V_{IO}$	Input offset voltage	$V_O = 0$ $R_S = 50\ \Omega$	$T_A = 25^\circ\text{C}$		2	3	mV
			$T_A = \text{Full range}$			5	
$\alpha$	Temperature coefficient of input offset voltage	$V_O = 0$ $R_S = 50\ \Omega$	$T_A = \text{Full range}$		18		$\mu\text{V}/^\circ\text{C}$
$I_{IO}$	Input offset current	$V_O = 0$	$T_A = 25^\circ\text{C}$		5	100	pA
			$T_A = \text{Full range}$			2	nA
$I_{IB}$	Input bias current (3)	$V_O = 0$	$T_A = 25^\circ\text{C}$		65	200	pA
			$T_A = \text{Full range}$			7	nA
$V_{ICR}$	Common-mode input voltage range	$T_A = 25^\circ\text{C}$		$\pm 11$	–12 to 15		V
$V_{OM}$	Maximum peak output voltage swing	$R_L = 10\ \text{k}\Omega$ $R_L \geq 10\ \text{k}\Omega$ $R_L \geq 2\ \text{k}\Omega$	$T_A = 25^\circ\text{C}$		$\pm 12$	$\pm 13.5$	V
			$T_A = \text{Full range}$		$\pm 12$		
					$\pm 10$		
$A_{VD}$	Large-signal differential voltage amplification	$V_O = \pm 10\ \text{V}$ $R_L \geq 2\ \text{k}\Omega$	$T_A = 25^\circ\text{C}$		50	200	V/mV
			$T_A = \text{Full range}$		25		
$B_1$	Utility-gain bandwidth	$T_A = 25^\circ\text{C}$			3		MHz
$r_i$	Input resistance	$T_A = 25^\circ\text{C}$			$10^{12}$		$\Omega$
CMRR	Common-mode rejection ratio	$V_{IC} = V_{ICR(\text{min})}$ $V_O = 0$ $R_S = 50\ \Omega$	$T_A = 25^\circ\text{C}$		75	100	dB
$k_{SVR}$	Supply-voltage rejection ratio ( $\Delta V_{CC\pm}/\Delta V_{IO}$ )	$V_{CC} = \pm 9\ \text{V}$ to $\pm 15\ \text{V}$ $V_O = 0$ $R_S = 50\ \Omega$	$T_A = 25^\circ\text{C}$		80	100	dB
$I_{CC}$	Supply current (each amplifier)	$V_O = 0$ ; no load	$T_A = 25^\circ\text{C}$		1.4	2.5	mA
$V_{O1} / V_{O2}$	Crosstalk attenuation	$A_{VD} = 100$	$T_A = 25^\circ\text{C}$		120		dB

- (1) All characteristics are measured under open-loop conditions with zero common-mode voltage, unless otherwise specified.
- (2) Full range is  $T_A = 0^\circ\text{C}$  to  $70^\circ\text{C}$ .
- (3) Input bias currents of an FET-input operational amplifier are normal junction reverse currents, which are temperature sensitive, as shown in Figure 6-40. Pulse techniques must be used that maintain the junction temperature as close to the ambient temperature as possible.

## 6.21 Electrical Characteristics: TL071I, TL072I, TL074I

$V_{CC\pm} = \pm 15\text{ V}$  (unless otherwise noted)

PARAMETER		TEST CONDITIONS (1) (2)		MIN	TYP	MAX	UNIT
$V_{IO}$	Input offset voltage	$V_O = 0$ $R_S = 50\ \Omega$	$T_A = 25^\circ\text{C}$		3	6	mV
			$T_A = \text{Full range}$			8	
$\alpha$	Temperature coefficient of input offset voltage	$V_O = 0$ $R_S = 50\ \Omega$	$T_A = \text{Full range}$		18		$\mu\text{V}/^\circ\text{C}$
$I_{IO}$	Input offset current	$V_O = 0$	$T_A = 25^\circ\text{C}$		5	100	pA
			$T_A = \text{Full range}$			2	nA
$I_{IB}$	Input bias current (3)	$V_O = 0$	$T_A = 25^\circ\text{C}$		65	200	pA
			$T_A = \text{Full range}$			7	nA
$V_{ICR}$	Common-mode input voltage range	$T_A = 25^\circ\text{C}$		$\pm 11$	–12 to 15		V
$V_{OM}$	Maximum peak output voltage swing	$R_L = 10\ \text{k}\Omega$	$T_A = 25^\circ\text{C}$	$\pm 12$	$\pm 13.5$		V
		$R_L \geq 10\ \text{k}\Omega$	$T_A = \text{Full range}$	$\pm 12$			
		$R_L \geq 2\ \text{k}\Omega$		$\pm 10$			
$A_{VD}$	Large-signal differential voltage amplification	$V_O = \pm 10\ \text{V}$ $R_L \geq 2\ \text{k}\Omega$	$T_A = 25^\circ\text{C}$	50	200		V/mV
			$T_A = \text{Full range}$	25			
$B_1$	Utility-gain bandwidth	$T_A = 25^\circ\text{C}$			3		MHz
$r_i$	Input resistance	$T_A = 25^\circ\text{C}$			$10^{12}$		$\Omega$
CMRR	Common-mode rejection ratio	$V_{IC} = V_{ICR(\text{min})}$ $V_O = 0$ $R_S = 50\ \Omega$	$T_A = 25^\circ\text{C}$	75	100		dB
$k_{SVR}$	Supply-voltage rejection ratio ( $\Delta V_{CC\pm}/\Delta V_{IO}$ )	$V_{CC} = \pm 9\ \text{V}$ to $\pm 15\ \text{V}$ $V_O = 0$ $R_S = 50\ \Omega$	$T_A = 25^\circ\text{C}$	80	100		dB
$I_{CC}$	Supply current (each amplifier)	$V_O = 0$ ; no load	$T_A = 25^\circ\text{C}$		1.4	2.5	mA
$V_{O1} / V_{O2}$	Crosstalk attenuation	$A_{VD} = 100$	$T_A = 25^\circ\text{C}$		120		dB

- (1) All characteristics are measured under open-loop conditions with zero common-mode voltage, unless otherwise specified.
- (2)  $T_A = -40^\circ\text{C}$  to  $85^\circ\text{C}$ .
- (3) Input bias currents of an FET-input operational amplifier are normal junction reverse currents, which are temperature sensitive, as shown in Figure 6-40. Pulse techniques must be used that maintain the junction temperature as close to the ambient temperature as possible.

## 6.22 Electrical Characteristics, TL07xC, TL07xAC, TL07xBC, TL07xI

$V_{CC\pm} = \pm 15\text{ V}$  (unless otherwise noted)

PARAMETER	TEST CONDITIONS <sup>(1)</sup>	$T_A$ <sup>(2)</sup>	TL071C, TL072C, TL074C			TL071AC, TL072AC, TL074AC			TL071BC, TL072BC, TL074BC			TL071I, TL072I, TL074I			UNIT
			MIN	TYP	MAX	MIN	TYP	MAX	MIN	TYP	MAX	MIN	TYP	MAX	
$V_{IO}$ Input offset voltage	$V_O = 0, R_S = 50\ \Omega$	25°C	3 10			3 6			2 3			3 6			mV
		Full range	13			7.5			5			8			
$^aV_{IO}$ Temperature coefficient of input offset voltage	$V_O = 0, R_S = 50\ \Omega$	Full range	18			18			18			18			$\mu\text{V}/^\circ\text{C}$
$I_{IO}$ Input offset current	$V_O = 0$	25°C	5 100			5 100			5 100			5 100			pA
		Full range	10			2			2			2			nA
$I_{IB}$ Input bias current <sup>(3)</sup>	$V_O = 0$	25°C	65 200			65 200			65 200			65 200			pA
		Full range	7			7			7			7			nA
$V_{ICR}$ Common-mode input voltage range		25°C	$\pm 11$	-12 to 15		$\pm 11$	-12 to 15		$\pm 11$	-12 to 15		$\pm 11$	-12 to 15	V	
$V_{OM}$ Maximum peak output voltage swing	$R_L = 10\ \text{k}\Omega$	25°C	$\pm 12$	$\pm 13.5$		$\pm 12$	$\pm 13.5$		$\pm 12$	$\pm 13.5$		$\pm 12$	$\pm 13.5$	V	
	$R_L \geq 10\ \text{k}\Omega$		$\pm 12$			$\pm 12$			$\pm 12$			$\pm 12$			
	$R_L \geq 2\ \text{k}\Omega$	Full range	$\pm 10$			$\pm 10$			$\pm 10$			$\pm 10$			
$A_{VD}$ Large-signal differential voltage amplification	$V_O = \pm 10\ \text{V}, R_L \geq 2\ \text{k}\Omega$	25°C	25	200		50	200		50	200		50	200	V/mV	
		Full range	15			25			25			25			
$B_1$ Unity-gain bandwidth		25°C	3			3			3			3			MHz
$r_i$ Input resistance		25°C	$10^{12}$			$10^{12}$			$10^{12}$			$10^{12}$			$\Omega$
CMRR Common-mode rejection ratio	$V_{IC} = V_{ICRmin}, V_O = 0, R_S = 50\ \Omega$	25°C	70	100		75	100		75	100		75	100	dB	
$k_{SVR}$ Supply-voltage rejection ratio ( $\Delta V_{CC\pm}/\Delta V_{IO}$ )	$V_{CC} = \pm 9\ \text{V to } \pm 15\ \text{V}, V_O = 0, R_S = 50\ \Omega$	25°C	70	100		80	100		80	100		80	100	dB	
$I_{CC}$ Supply current (each amplifier)	$V_O = 0, \text{No load}$	25°C	1.4 2.5			1.4 2.5			1.4 2.5			1.4 2.5			mA
$V_{O1}/V_{O2}$ Crosstalk attenuation	$A_{VD} = 100$	25°C	120			120			120			120			dB

- (1) All characteristics are measured under open-loop conditions with zero common-mode voltage, unless otherwise specified.
- (2) Full range is  $T_A = 0^\circ\text{C to } 70^\circ\text{C}$  for TL07\_C, TL07\_AC, TL07\_BC and is  $T_A = -40^\circ\text{C to } 85^\circ\text{C}$  for TL07\_I.
- (3) Input bias currents of an FET-input operational amplifier are normal junction reverse currents, which are temperature sensitive, as shown in Figure 6-40. Pulse techniques must be used that maintain the junction temperature as close to the ambient temperature as possible.

## 6.23 Electrical Characteristics: TL071M, TL072M

$V_{CC\pm} = \pm 15\text{ V}$  (unless otherwise noted)

PARAMETER		TEST CONDITIONS (1) (2)		MIN	TYP	MAX	UNIT	
$V_{IO}$	Input offset voltage	$V_O = 0$ $R_S = 50\ \Omega$	$T_A = 25^\circ\text{C}$		3	6	mV	
			$T_A = \text{Full range}$			9		
$\alpha_{VIO}$	Temperature coefficient of input offset voltage	$V_O = 0$ $R_S = 50\ \Omega$	$T_A = \text{Full range}$		18		$\mu\text{V}/^\circ\text{C}$	
$I_{IO}$	Input offset current	$V_O = 0$	$T_A = 25^\circ\text{C}$		5	100	pA	
			$T_A = \text{Full range}$				20	nA
$I_{IB}$	Input bias current	$V_O = 0$	$T_A = 25^\circ\text{C}$		65	200	pA	
			$T_A = \text{Full range}$				50	nA
$V_{ICR}$	Common-mode input voltage range	$T_A = 25^\circ\text{C}$			$\pm 11$	-12 to 15	V	
$V_{OM}$	Maximum peak output voltage swing	$R_L = 10\ \text{k}\Omega$ $R_L \geq 10\ \text{k}\Omega$ $R_L \geq 2\ \text{k}\Omega$	$T_A = 25^\circ\text{C}$		$\pm 12$	$\pm 13.5$	V	
			$T_A = \text{Full range}$			$\pm 12$		
						$\pm 10$		
$A_{VD}$	Large-signal differential voltage amplification	$V_O = \pm 10\ \text{V}$ $R_L \geq 2\ \text{k}\Omega$	$T_A = 25^\circ\text{C}$		35	200	V/mV	
			$T_A = \text{Full range}$			15		
$B_1$	Unity-gain bandwidth				3		MHz	
$r_i$	Input resistance				$10^{12}$		$\Omega$	
CMRR	Common-mode rejection ratio	$V_{IC} = V_{ICR(\text{min})}$ $V_O = 0$ $R_S = 50\ \Omega$	$T_A = 25^\circ\text{C}$		80	86	dB	
$k_{SVR}$	Supply-voltage rejection ratio ( $\Delta V_{CC\pm}/\Delta V_{IO}$ )	$V_{CC} = \pm 9\ \text{V}$ to $\pm 15\ \text{V}$ $V_O = 0$ $R_S = 50\ \Omega$	$T_A = 25^\circ\text{C}$		80	86	dB	
$I_{CC}$	Supply current (each amplifier)	$V_O = 0$ ; no load	$T_A = 25^\circ\text{C}$		1.4	2.5	mA	
$V_{O1}/V_{O2}$	Crosstalk attenuation	$A_{VD} = 100$	$T_A = 25^\circ\text{C}$		120		dB	

- (1) Input bias currents of an FET-input operational amplifier are normal junction reverse currents, which are temperature sensitive, as shown in Figure 6-40. Pulse techniques that maintain the junction temperature as close to the ambient temperature as possible must be used.
- (2) All characteristics are measured under open-loop conditions with zero common-mode voltage, unless otherwise specified. Full range is  $T_A = -55^\circ\text{C}$  to  $+125^\circ\text{C}$ .

## 6.24 Electrical Characteristics: TL074M

 $V_{CC\pm} = \pm 15\text{ V}$  (unless otherwise noted)

PARAMETER		TEST CONDITIONS (1) (2)		MIN	TYP	MAX	UNIT
$V_{IO}$	Input offset voltage	$V_O = 0$ $R_S = 50\ \Omega$	$T_A = 25^\circ\text{C}$		3	9	mV
			$T_A = \text{Full range}$			15	
$\alpha_{VIO}$	Temperature coefficient of input offset voltage	$V_O = 0, R_S = 50\ \Omega$	$T_A = \text{Full range}$		18		$\mu\text{V}/^\circ\text{C}$
$I_{IO}$	Input offset current	$V_O = 0$	$T_A = 25^\circ\text{C}$		5	100	pA
			$T_A = \text{Full range}$			20	nA
$I_{IB}$	Input bias current	$V_O = 0$	$T_A = 25^\circ\text{C}$		65	200	pA
			$T_A = \text{Full range}$			20	nA
$V_{ICR}$	Common-mode input voltage range	$T_A = 25^\circ\text{C}$		$\pm 11$	–12 to 15		V
$V_{OM}$	Maximum peak output voltage swing	$R_L = 10\ \text{k}\Omega$ $R_L \geq 10\ \text{k}\Omega$ $R_L \geq 2\ \text{k}\Omega$	$T_A = 25^\circ\text{C}$	$\pm 12$	$\pm 13.5$		V
			$T_A = \text{Full range}$	$\pm 12$			
				$\pm 10$			
$A_{VD}$	Large-signal differential voltage amplification	$V_O = \pm 10\ \text{V}$ $R_L \geq 2\ \text{k}\Omega$	$T_A = 25^\circ\text{C}$	35	200		V/mV
			$T_A = \text{Full range}$	15			
$B_1$	Unity-gain bandwidth				3		MHz
$r_i$	Input resistance				$10^{12}$		$\Omega$
CMRR	Common-mode rejection ratio	$V_{IC} = V_{ICR(\text{min})}$ $V_O = 0$ $R_S = 50\ \Omega$	$T_A = 25^\circ\text{C}$	80	86		dB
$k_{SVR}$	Supply-voltage rejection ratio ( $\Delta V_{CC\pm}/\Delta V_{IO}$ )	$V_{CC} = \pm 9\ \text{V to } \pm 15\ \text{V}$ $V_O = 0$ $R_S = 50\ \Omega$	$T_A = 25^\circ\text{C}$	80	86		dB
$I_{CC}$	Supply current (each amplifier)	$V_O = 0$ ; no load	$T_A = 25^\circ\text{C}$		1.4	2.5	mA
$V_{O1} / V_{O2}$	Crosstalk attenuation	$A_{VD} = 100$	$T_A = 25^\circ\text{C}$		120		dB

- Input bias currents of an FET-input operational amplifier are normal junction reverse currents, which are temperature sensitive, as shown in Figure 6-40. Pulse techniques that maintain the junction temperature as close to the ambient temperature as possible must be used.
- All characteristics are measured under open-loop conditions with zero common-mode voltage, unless otherwise specified. Full range is  $T_A = -55^\circ\text{C to } +125^\circ\text{C}$ .

## 6.25 Switching Characteristics: TL07xM

$V_{CC\pm} = \pm 15\text{ V}$ ,  $T_A = 25^\circ\text{C}$

PARAMETER		TEST CONDITIONS		MIN	TYP	MAX	UNIT
SR	Slew rate at unity gain	$V_I = 10\text{ V}$ $C_L = 100\text{ pF}$	$R_L = 2\text{ k}\Omega$ See <a href="#">Figure 7-1</a>	5	13		V/ $\mu\text{s}$
$t_r$	Rise-time overshoot factor	$V_I = 20\text{ V}$ $C_L = 100\text{ pF}$	$R_L = 2\text{ k}\Omega$ See <a href="#">Figure 7-1</a>		0.1		$\mu\text{s}$
					20%		
$V_n$	Equivalent input noise voltage	$R_S = 20\ \Omega$	$f = 1\text{ kHz}$		18		$\text{nV}/\sqrt{\text{Hz}}$
			$f = 10\text{ Hz to }10\text{ kHz}$		4		$\mu\text{V}$
$I_n$	Equivalent input noise current	$R_S = 20\ \Omega$	$f = 1\text{ kHz}$		0.01		$\text{pA}/\sqrt{\text{Hz}}$
THD	Total harmonic distortion	$V_{\text{rms}} = 6\text{ V}$ $R_L \geq 2\text{ k}\Omega$ $f = 1\text{ kHz}$	$A_{\text{VD}} = 1$ $R_S \leq 1\text{ k}\Omega$		0.003%		

## 6.26 Switching Characteristics: TL07xC, TL07xAC, TL07xBC, TL07xI

$V_{CC\pm} = \pm 15\text{ V}$ ,  $T_A = 25^\circ\text{C}$

PARAMETER		TEST CONDITIONS		MIN	TYP	MAX	UNIT
SR	Slew rate at unity gain	$V_I = 10\text{ V}$ $C_L = 100\text{ pF}$	$R_L = 2\text{ k}\Omega$ See <a href="#">Figure 7-1</a>	8	13		V/ $\mu\text{s}$
$t_r$	Rise-time overshoot factor	$V_I = 20\text{ V}$ $C_L = 100\text{ pF}$	$R_L = 2\text{ k}\Omega$ See <a href="#">Figure 7-1</a>		0.1		$\mu\text{s}$
					20%		
$V_n$	Equivalent input noise voltage	$R_S = 20\ \Omega$	$f = 1\text{ kHz}$		18		$\text{nV}/\sqrt{\text{Hz}}$
			$f = 10\text{ Hz to }10\text{ kHz}$		4		$\mu\text{V}$
$I_n$	Equivalent input noise current	$R_S = 20\ \Omega$	$f = 1\text{ kHz}$		0.01		$\text{pA}/\sqrt{\text{Hz}}$
THD	Total harmonic distortion	$V_{\text{rms}} = 6\text{ V}$ $R_L \geq 2\text{ k}\Omega$ $f = 1\text{ kHz}$	$A_{\text{VD}} = 1$ $R_S \leq 1\text{ k}\Omega$		0.003%		



## 6.27 Electrical Characteristics, TL07xM

 $V_{CC\pm} = \pm 15\text{ V}$  (unless otherwise noted)

PARAMETER	TEST CONDITIONS <sup>(1)</sup>	T <sub>A</sub> <sup>(2)</sup>	TL071M, TL072M			TL074M			UNIT	
			MIN	TYP	MAX	MIN	TYP	MAX		
V <sub>IO</sub>	Input offset voltage	V <sub>O</sub> = 0, R <sub>S</sub> = 50 Ω	25°C		3	6	3		9	mV
			Full range					9	15	
α <sub>VIO</sub>	Temperature coefficient of input offset voltage	V <sub>O</sub> = 0, R <sub>S</sub> = 50 Ω	Full range		18		18		μV/°C	
I <sub>IO</sub>	Input offset current	V <sub>O</sub> = 0	25°C		5	100	5		100	pA
			Full range					20	20	nA
I <sub>IB</sub>	Input bias current	V <sub>O</sub> = 0	25°C		65	200	65		200	pA
			Full range					50	20	nA
V <sub>ICR</sub>	Common-mode input voltage range		25°C		±11 –12 to 15		±11 –12 to 15		V	
V <sub>OM</sub>	Maximum peak output voltage swing	R <sub>L</sub> = 10 kΩ	25°C		±12	±13.5	±12		±13.5	V
		R <sub>L</sub> ≥ 10 kΩ	Full range		±12		±12			
		R <sub>L</sub> ≥ 2 kΩ			±10		±10			
A <sub>VD</sub>	Large-signal differential voltage amplification	V <sub>O</sub> = ±10 V, R <sub>L</sub> ≥ 2 kΩ	25°C		35	200	35		200	V/mV
			Full range					15	15	
B <sub>1</sub>	Unity-gain bandwidth				3		3		MHz	
r <sub>i</sub>	Input resistance				10 <sup>12</sup>		10 <sup>12</sup>		Ω	
CMRR	Common-mode rejection ratio	V <sub>IC</sub> = V <sub>ICRmin</sub> , V <sub>O</sub> = 0, R <sub>S</sub> = 50 Ω	25°C		80	86	80		86	dB
k <sub>SVR</sub>	Supply-voltage rejection ratio (ΔV <sub>CC±</sub> /ΔV <sub>IO</sub> )	V <sub>CC</sub> = ±9 V to ±15 V, V <sub>O</sub> = 0, R <sub>S</sub> = 50 Ω	25°C		80	86	80		86	dB
I <sub>CC</sub>	Supply current (each amplifier)	V <sub>O</sub> = 0, No load	25°C		1.4	2.5	1.4		2.5	mA
V <sub>O1</sub> /V <sub>O2</sub>	Crosstalk attenuation	A <sub>VD</sub> = 100	25°C		120		120		dB	

- Input bias currents of an FET-input operational amplifier are normal junction reverse currents, which are temperature sensitive, as shown in Figure 6-40. Pulse techniques must be used that will maintain the junction temperature as close to the ambient temperature as possible.
- All characteristics are measured under open-loop conditions with zero common-mode voltage, unless otherwise specified. Full range is T<sub>A</sub> = –55°C to 125°C.

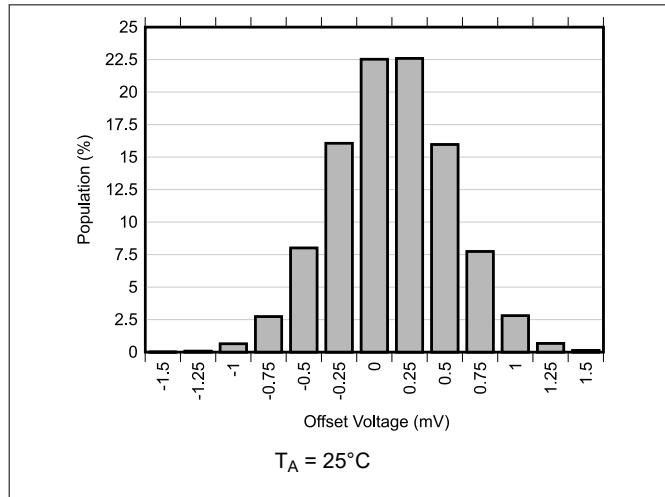
## 6.28 Switching Characteristics

 $V_{CC\pm} = \pm 15\text{ V}$ , T<sub>A</sub> = 25°C

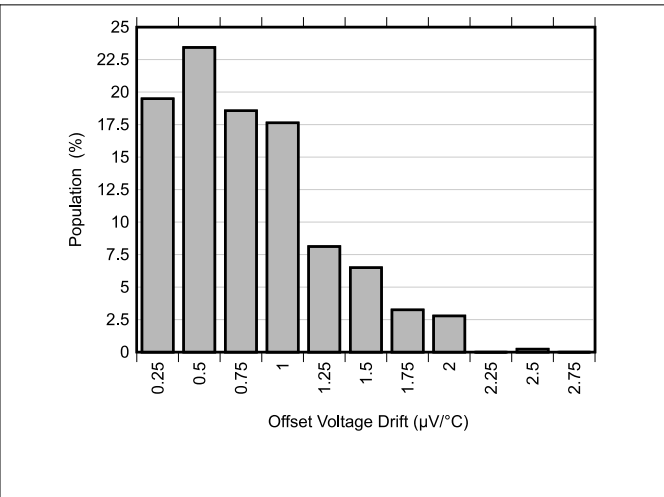
PARAMETER	TEST CONDITIONS	TL07xM			TL07xC, TL07xAC, TL07xBC, TL07xI TL075			UNIT
		MIN	TYP	MAX	MIN	TYP	MAX	
SR	Slew rate at unity gain	V <sub>I</sub> = 10 V, C <sub>L</sub> = 100 pF, R <sub>L</sub> = 2 kΩ, See Figure 7-1	5	13		8	13	V/μs
t <sub>r</sub>	Rise-time overshoot factor	V <sub>I</sub> = 20 V, C <sub>L</sub> = 100 pF, R <sub>L</sub> = 2 kΩ, See Figure 7-1	0.1		0.1			μs
			20%		20%			
V <sub>n</sub>	Equivalent input noise voltage	R <sub>S</sub> = 20 Ω	f = 1 kHz		18		18	nV/√Hz
			f = 10 Hz to 10 kHz		4		4	μV
I <sub>n</sub>	Equivalent input noise current	R <sub>S</sub> = 20 Ω, f = 1 kHz	0.01		0.01		pA/√Hz	
THD	Total harmonic distortion	V <sub>rms</sub> = 6 V, R <sub>L</sub> ≥ 2 kΩ, f = 1 kHz, A <sub>VD</sub> = 1, R <sub>S</sub> ≤ 1 kΩ,	0.003%		0.003%			

## 6.29 Typical Characteristics: TL07xH

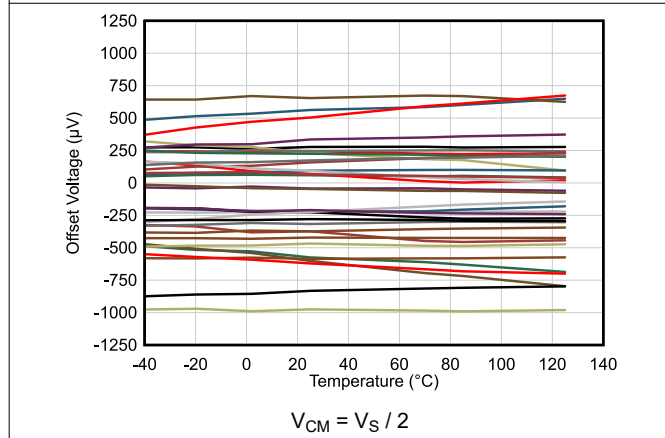
at  $T_A = 25^\circ\text{C}$ ,  $V_S = 40\text{ V}$  ( $\pm 20\text{ V}$ ),  $V_{CM} = V_S / 2$ ,  $R_{LOAD} = 10\text{ k}\Omega$  connected to  $V_S / 2$ , and  $C_L = 20\text{ pF}$  (unless otherwise noted)



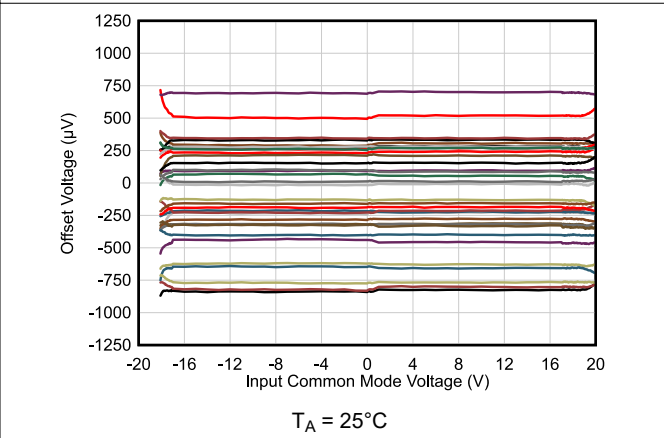
**Figure 6-1. Offset Voltage Production Distribution**



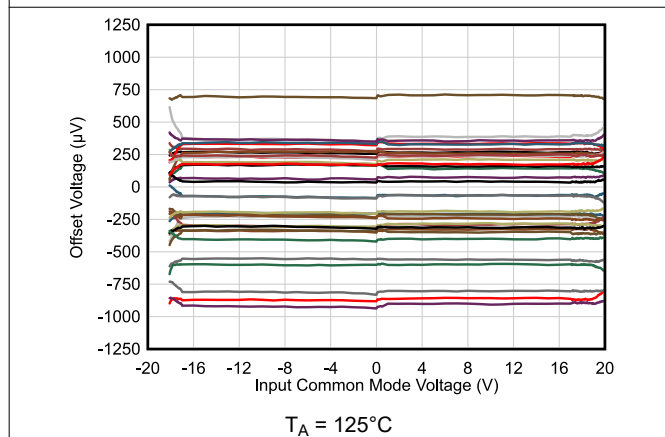
**Figure 6-2. Offset Voltage Drift Distribution**



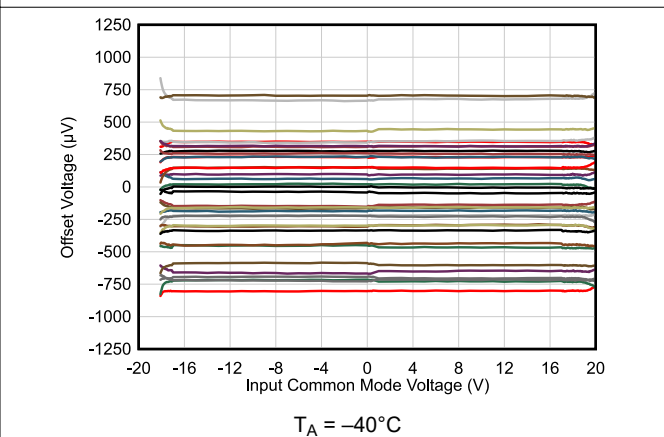
**Figure 6-3. Offset Voltage vs Temperature**



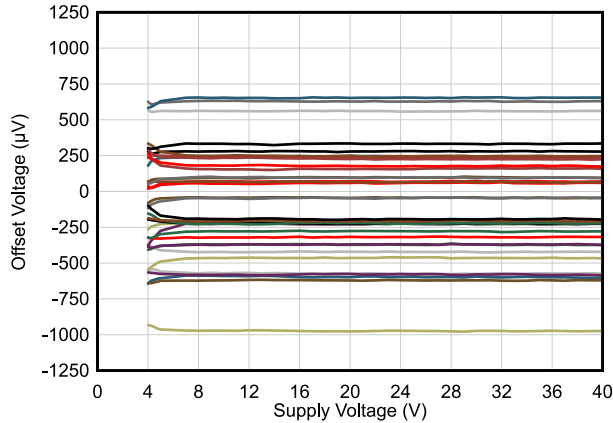
**Figure 6-4. Offset Voltage vs Common-Mode Voltage**



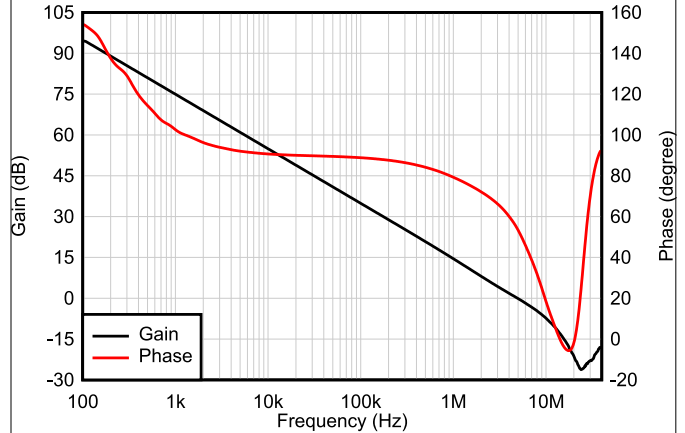
**Figure 6-5. Offset Voltage vs Common-Mode Voltage**



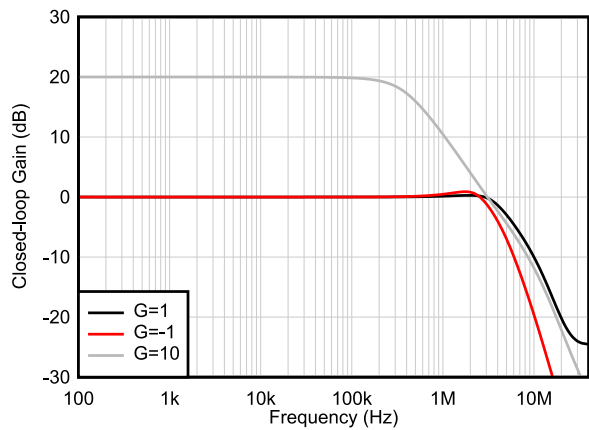
**Figure 6-6. Offset Voltage vs Common-Mode Voltage**



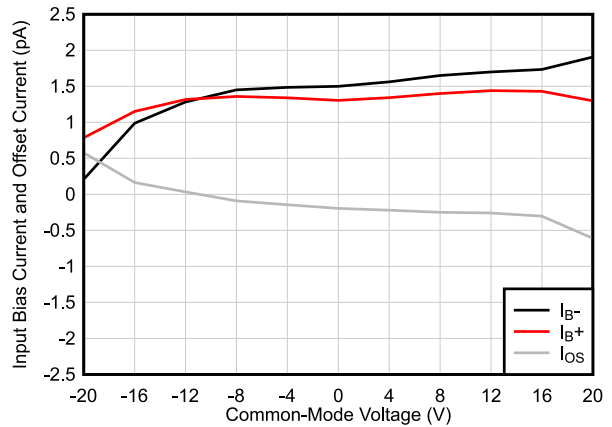
**Figure 6-7. Offset Voltage vs Power Supply**



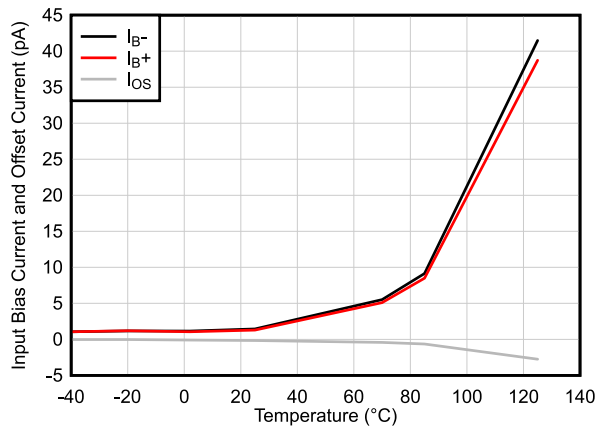
**Figure 6-8. Open-Loop Gain and Phase vs Frequency**



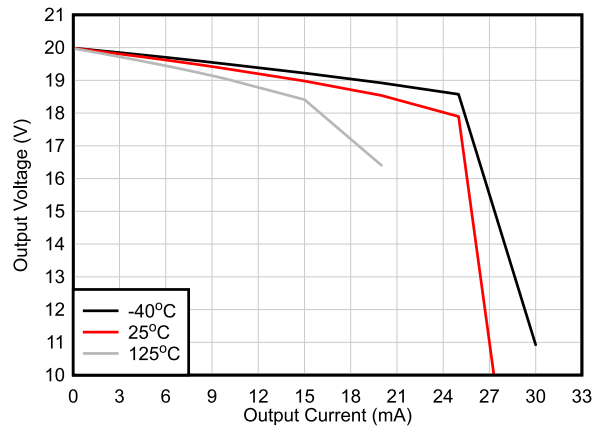
**Figure 6-9. Closed-Loop Gain vs Frequency**



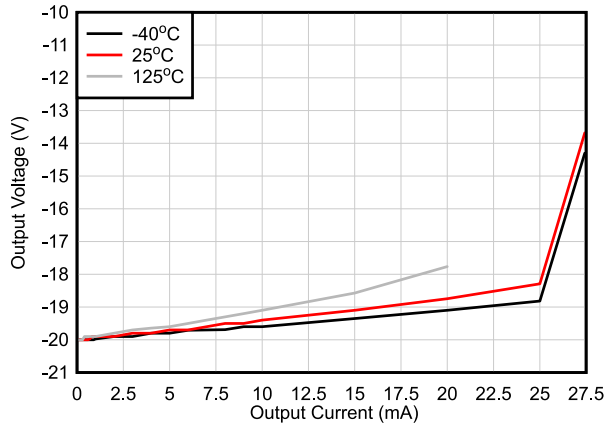
**Figure 6-10. Input Bias Current vs Common-Mode Voltage**



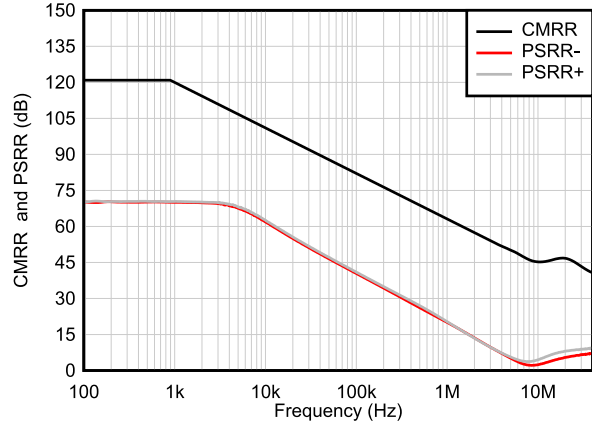
**Figure 6-11. Input Bias Current vs Temperature**



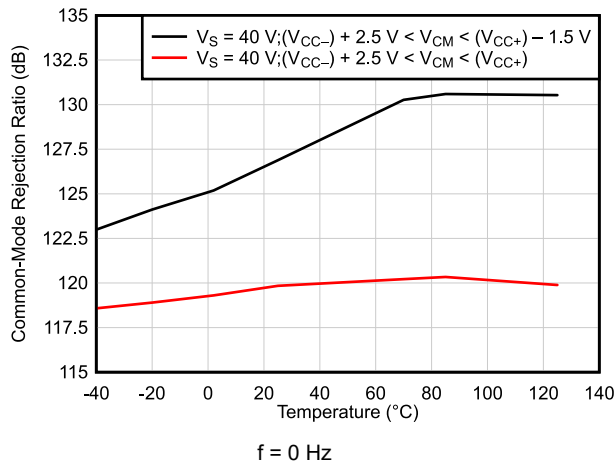
**Figure 6-12. Output Voltage Swing vs Output Current (Sourcing)**



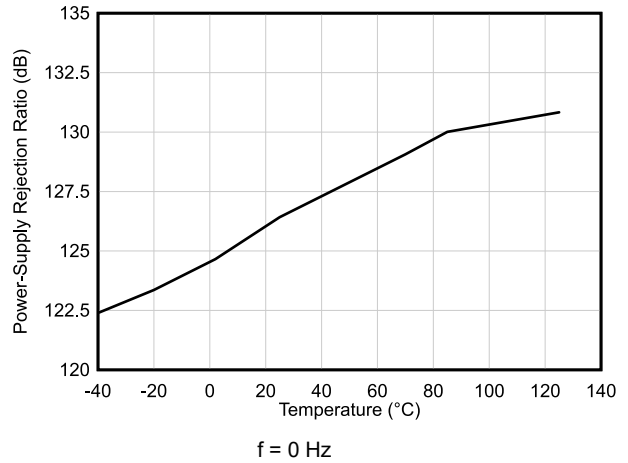
**Figure 6-13. Output Voltage Swing vs Output Current (Sinking)**



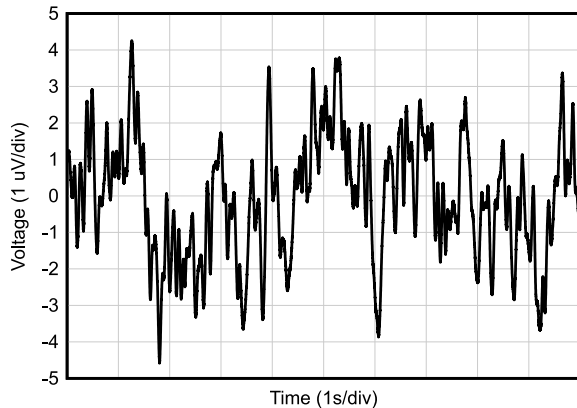
**Figure 6-14. CMRR and PSRR vs Frequency**



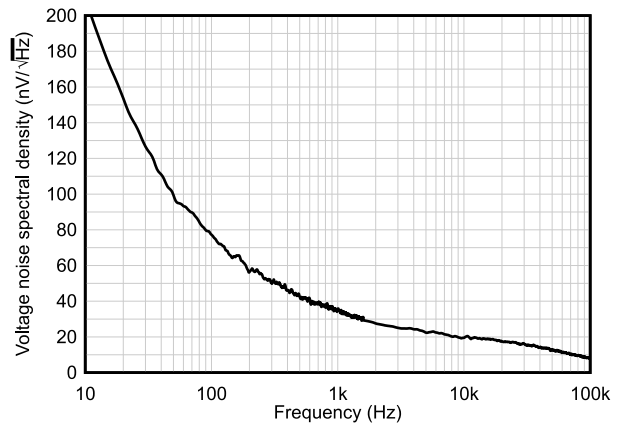
**Figure 6-15. CMRR vs Temperature (dB)**



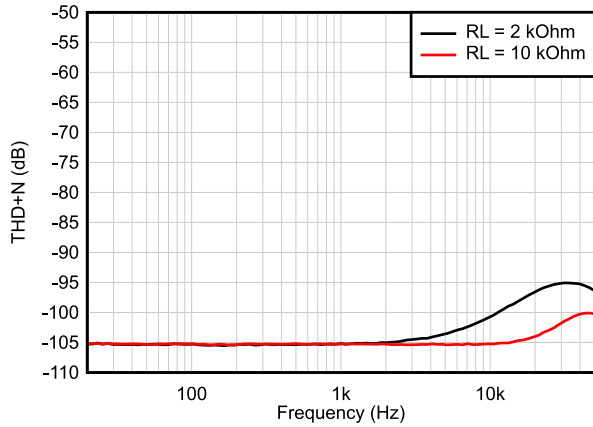
**Figure 6-16. PSRR vs Temperature (dB)**



**Figure 6-17. 0.1-Hz to 10-Hz Noise**

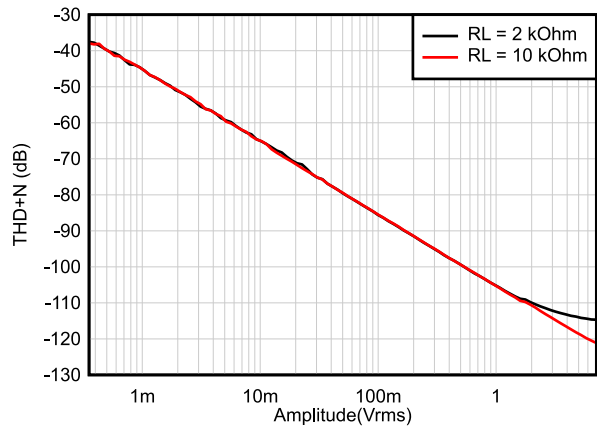


**Figure 6-18. Input Voltage Noise Spectral Density vs Frequency**



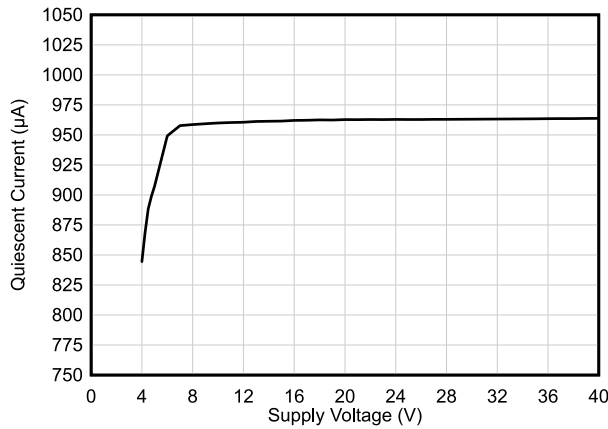
BW = 80 kHz,  $V_{OUT} = 1 V_{RMS}$

Figure 6-19. THD+N Ratio vs Frequency



BW = 80 kHz,  $f = 1 \text{ kHz}$

Figure 6-20. THD+N vs Output Amplitude



$V_{CM} = V_S / 2$

Figure 6-21. Quiescent Current vs Supply Voltage

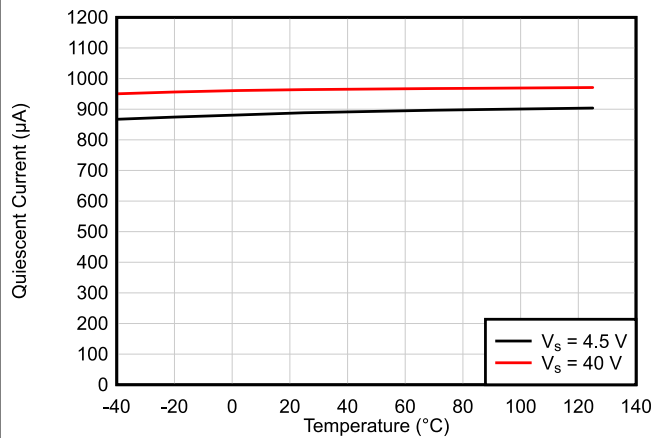


Figure 6-22. Quiescent Current vs Temperature

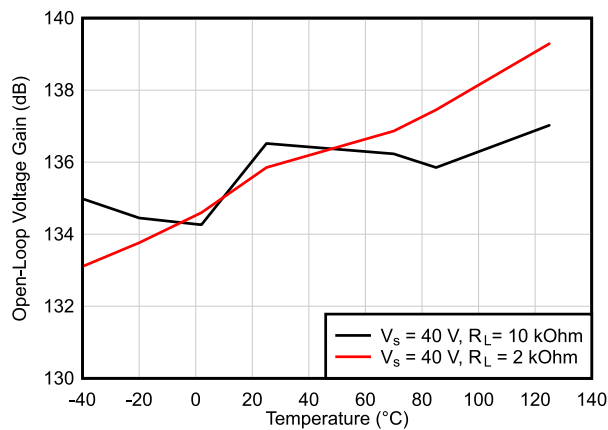


Figure 6-23. Open-Loop Voltage Gain vs Temperature (dB)

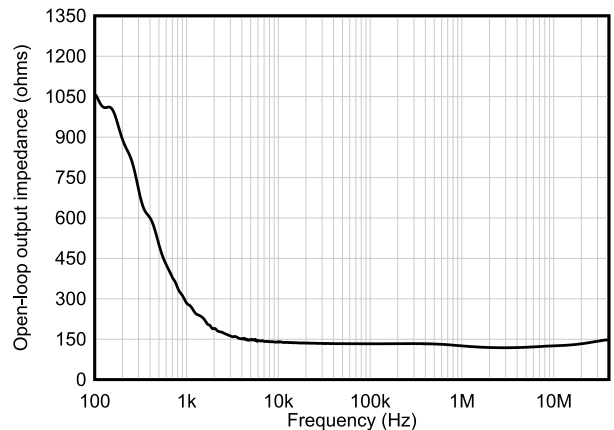
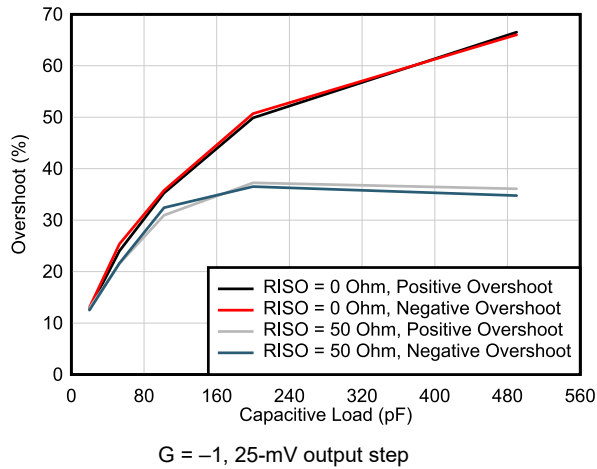
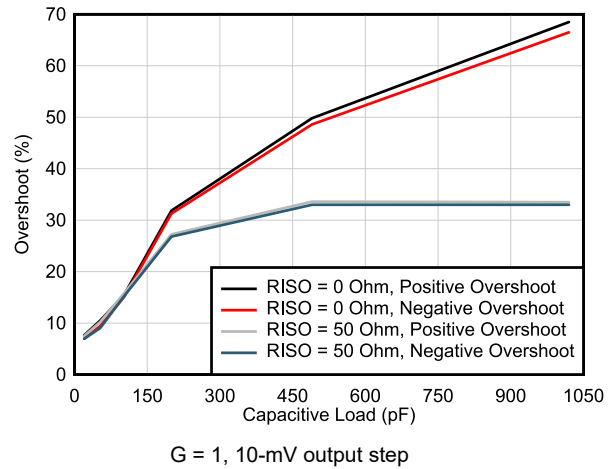


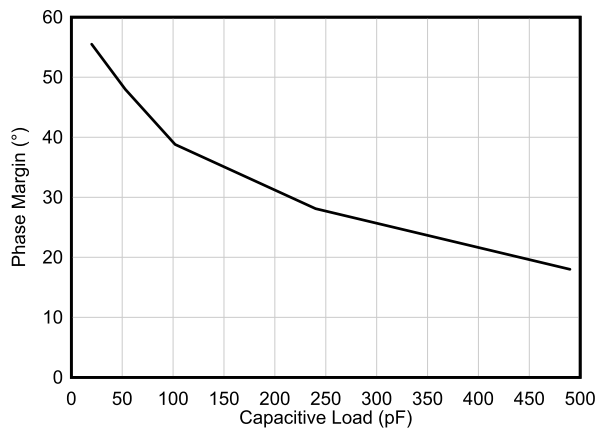
Figure 6-24. Open-Loop Output Impedance vs Frequency



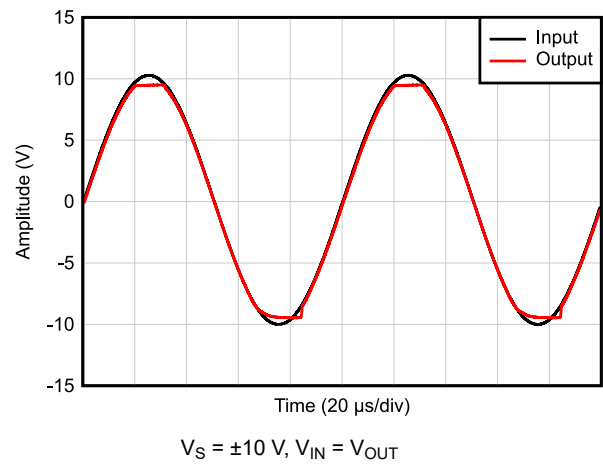
**Figure 6-25. Small-Signal Overshoot vs Capacitive Load**



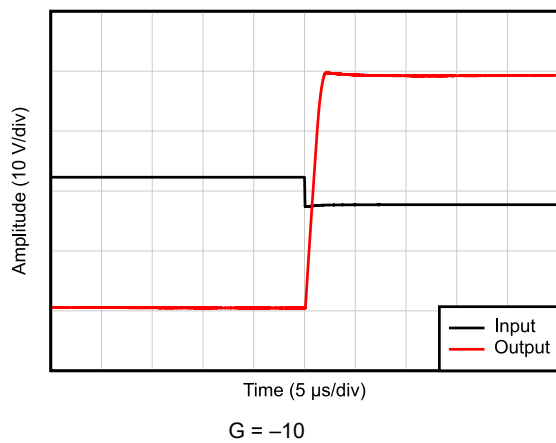
**Figure 6-26. Small-Signal Overshoot vs Capacitive Load**



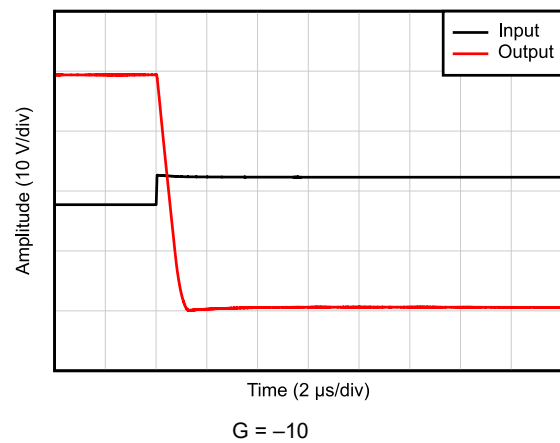
**Figure 6-27. Phase Margin vs Capacitive Load**



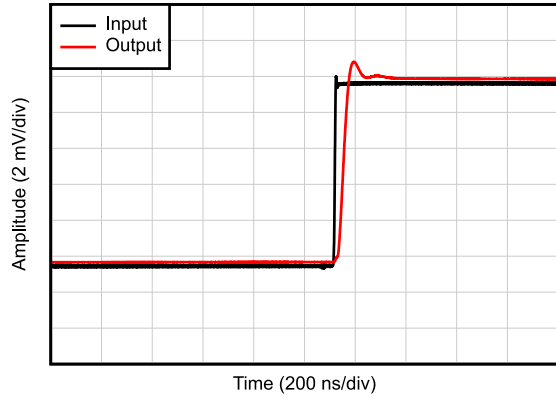
**Figure 6-28. No Phase Reversal**



**Figure 6-29. Positive Overload Recovery**

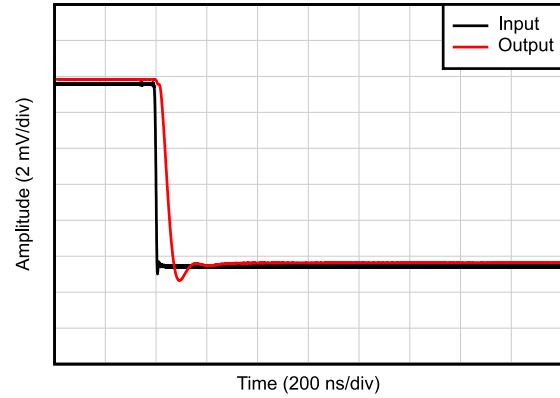


**Figure 6-30. Negative Overload Recovery**



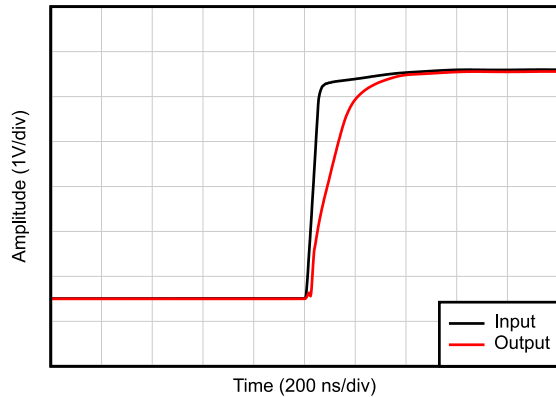
$C_L = 20 \text{ pF}$ ,  $G = 1$ , 10-mV step response

**Figure 6-31. Small-Signal Step Response, Rising**



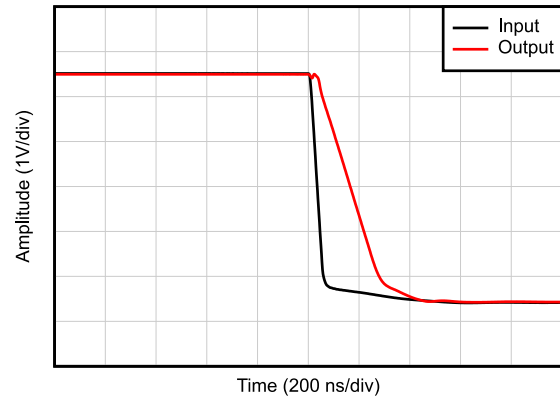
$C_L = 20 \text{ pF}$ ,  $G = 1$ , 10-mV step response

**Figure 6-32. Small-Signal Step Response, Falling**



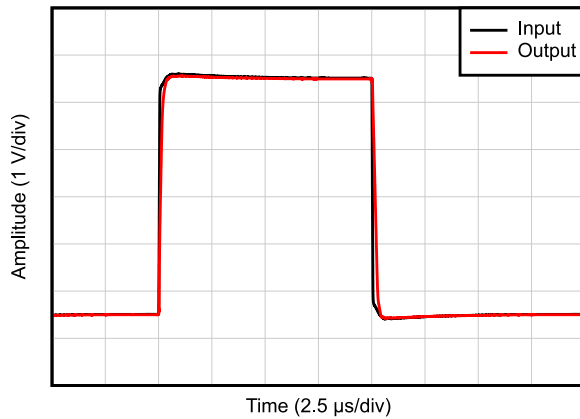
$C_L = 20 \text{ pF}$ ,  $G = 1$

**Figure 6-33. Large-Signal Step Response (Rising)**



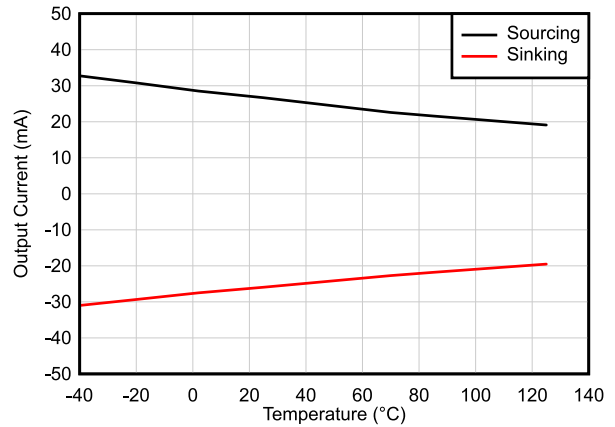
$C_L = 20 \text{ pF}$ ,  $G = 1$

**Figure 6-34. Large-Signal Step Response (Falling)**

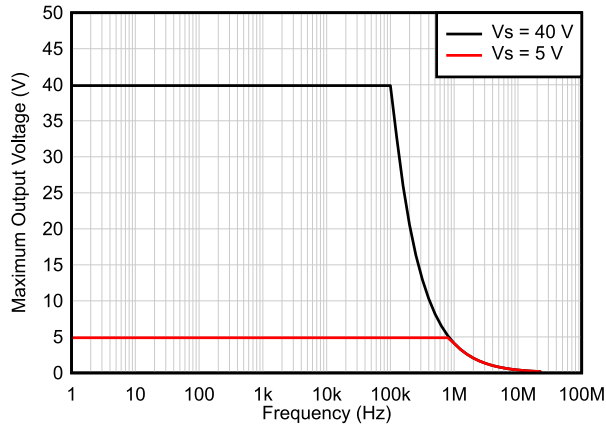


$C_L = 20 \text{ pF}$ ,  $G = 1$

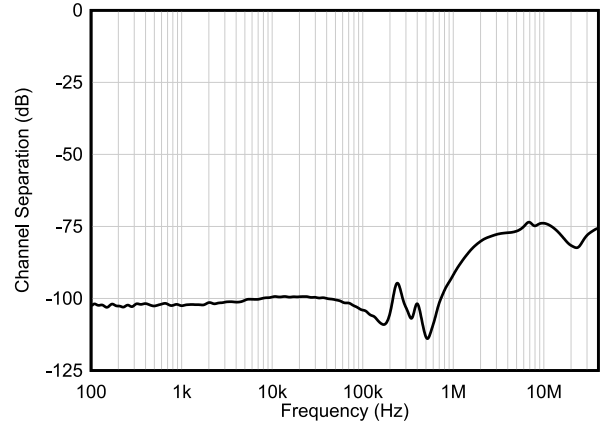
**Figure 6-35. Large-Signal Step Response**



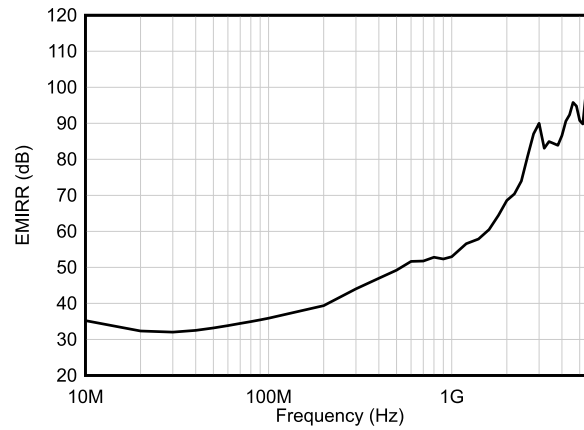
**Figure 6-36. Short-Circuit Current vs Temperature**



**Figure 6-37. Maximum Output Voltage vs Frequency**



**Figure 6-38. Channel Separation vs Frequency**



**Figure 6-39. EMIRR (Electromagnetic Interference Rejection Ratio) vs Frequency**



6.30 Typical Characteristics: All Devices Except TL07xH

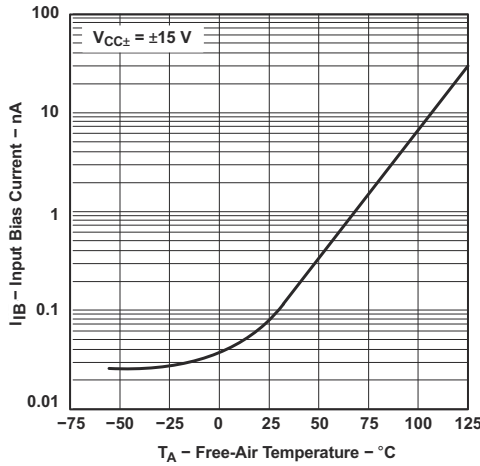


Figure 6-40. Input Bias Current vs Free-Air Temperature

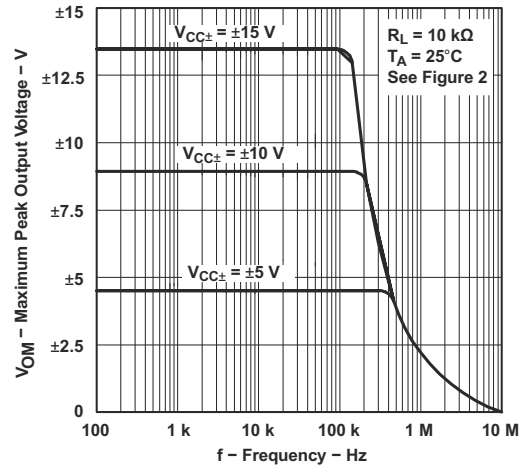


Figure 6-41. Maximum Peak Output Voltage vs Frequency

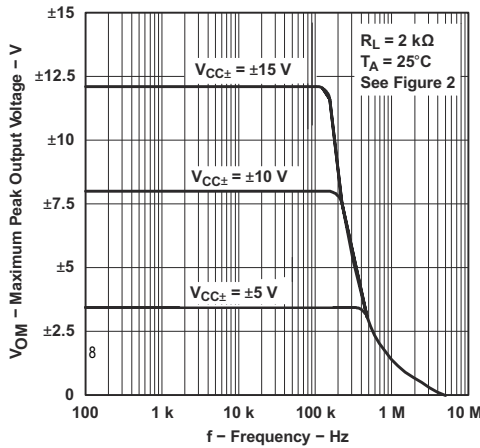


Figure 6-42. Maximum Peak Output Voltage vs Frequency

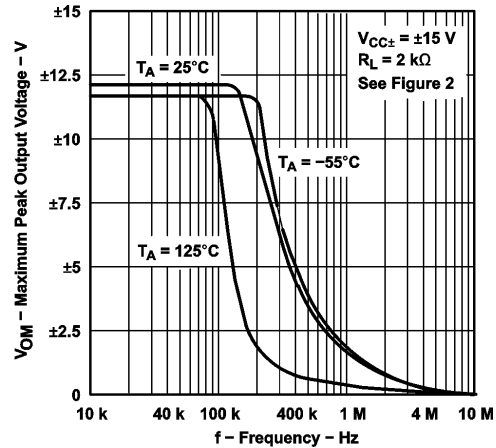


Figure 6-43. Maximum Peak Output Voltage vs Frequency

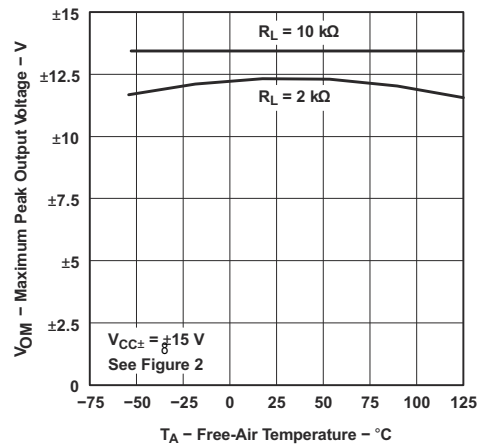


Figure 6-44. Maximum Peak Output Voltage vs Free-Air Temperature

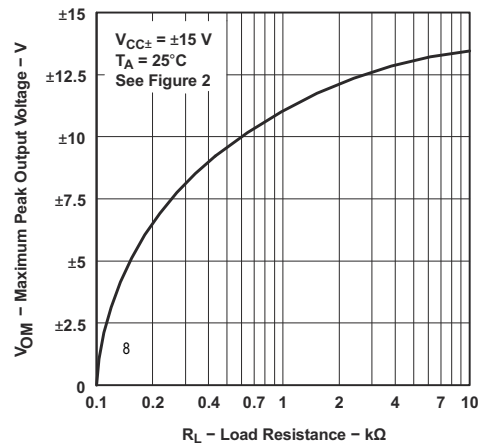
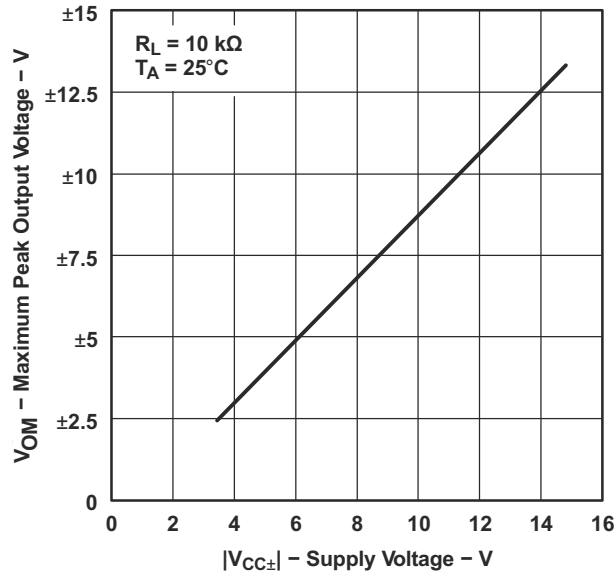
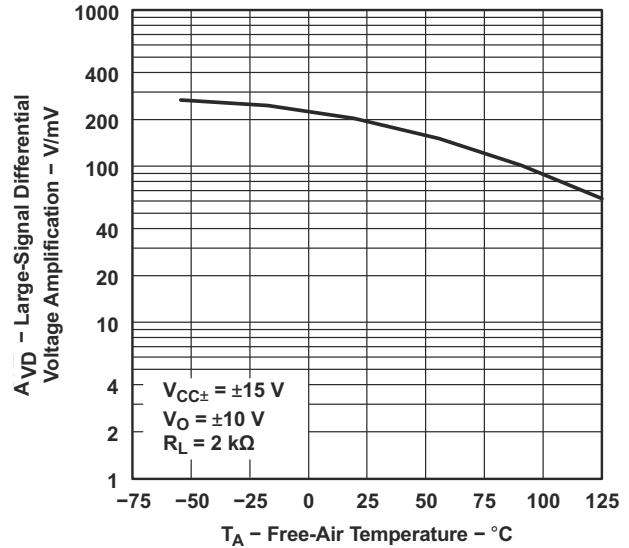


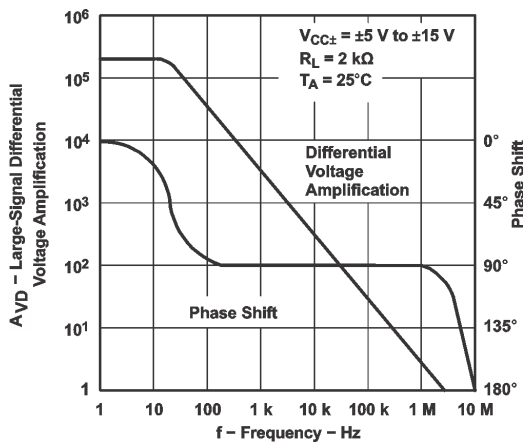
Figure 6-45. Maximum Peak Output Voltage vs Load Resistance



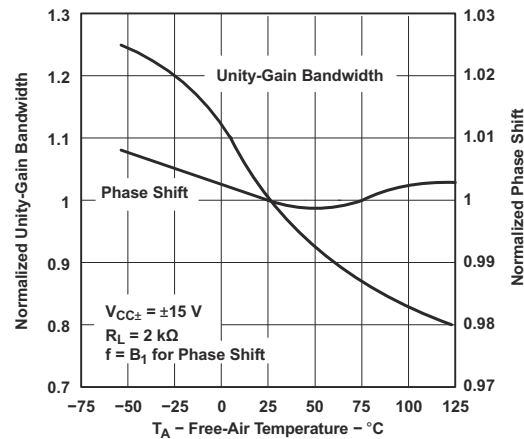
**Figure 6-46. Maximum Peak Output Voltage vs Supply Voltage**



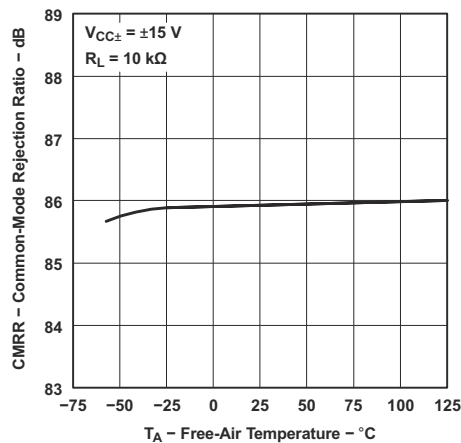
**Figure 6-47. Large-Signal Differential Voltage Amplification vs Free-Air Temperature**



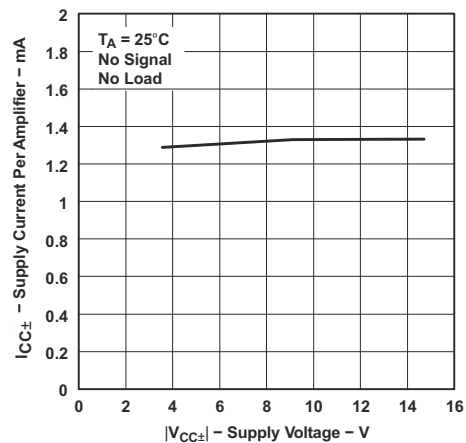
**Figure 6-48. Large-Signal Differential Voltage Amplification and Phase Shift vs Frequency**



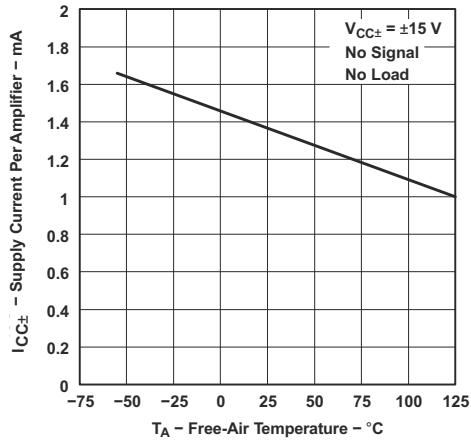
**Figure 6-49. Normalized Unity-Gain Bandwidth and Phase Shift vs Free-Air Temperature**



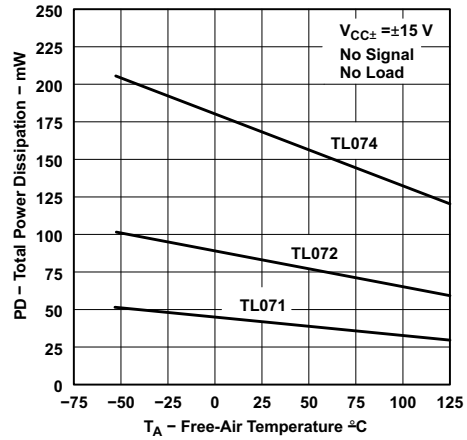
**Figure 6-50. Common-Mode Rejection Ratio vs Free-Air Temperature**



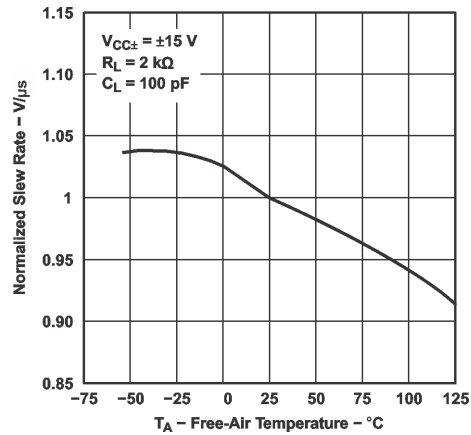
**Figure 6-51. Supply Current Per Amplifier vs Supply Voltage**



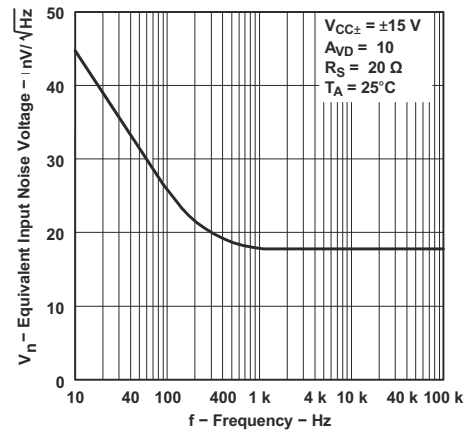
**Figure 6-52. Supply Current Per Amplifier vs Free-Air Temperature**



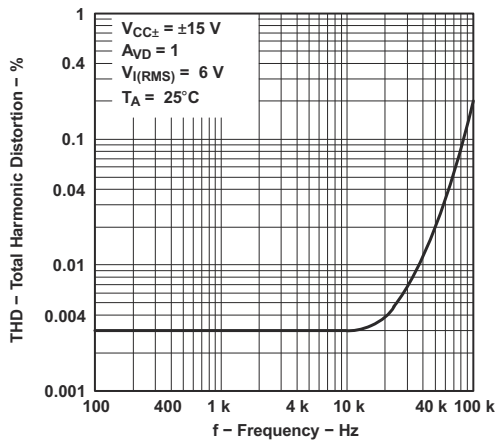
**Figure 6-53. Total Power Dissipation vs Free-Air Temperature**



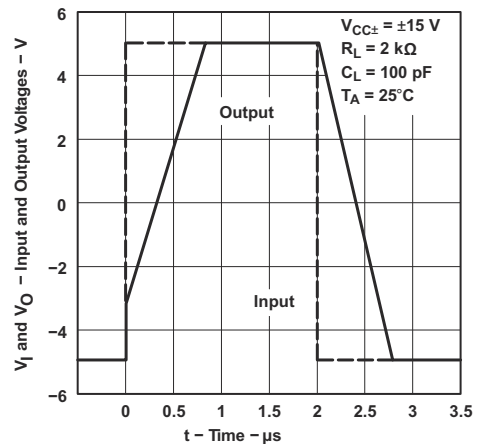
**Figure 6-54. Normalized Slew Rate vs Free-Air Temperature**



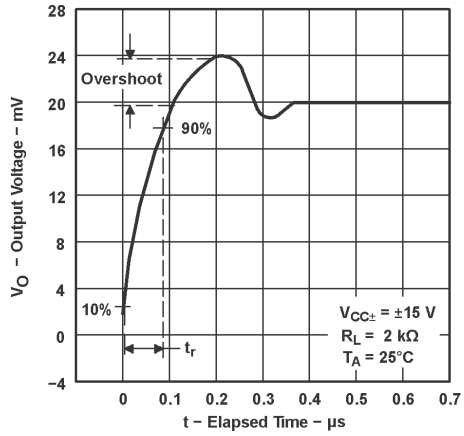
**Figure 6-55. Equivalent Input Noise Voltage vs Frequency**



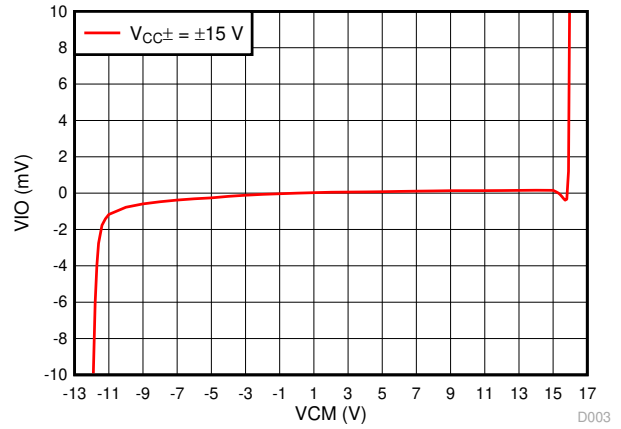
**Figure 6-56. Total Harmonic Distortion vs Frequency**



**Figure 6-57. Voltage-Follower Large-Signal Pulse Response**



**Figure 6-58. Output Voltage vs Elapsed Time**



**Figure 6-59.  $V_{IO}$  vs  $V_{CM}$**

## 7 Parameter Measurement Information

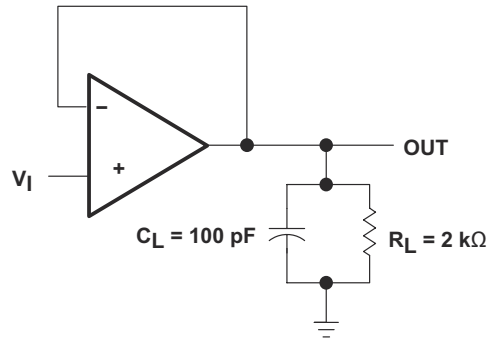


Figure 7-1. Unity-Gain Amplifier

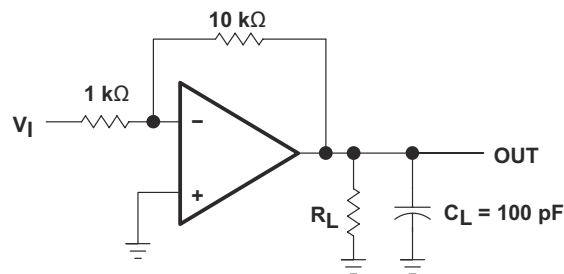


Figure 7-2. Gain-of-10 Inverting Amplifier

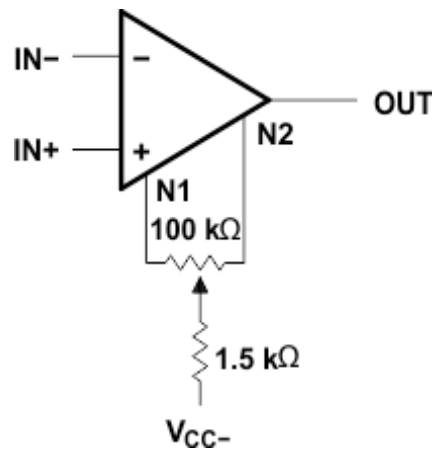


Figure 7-3. Input Offset-Voltage Null Circuit

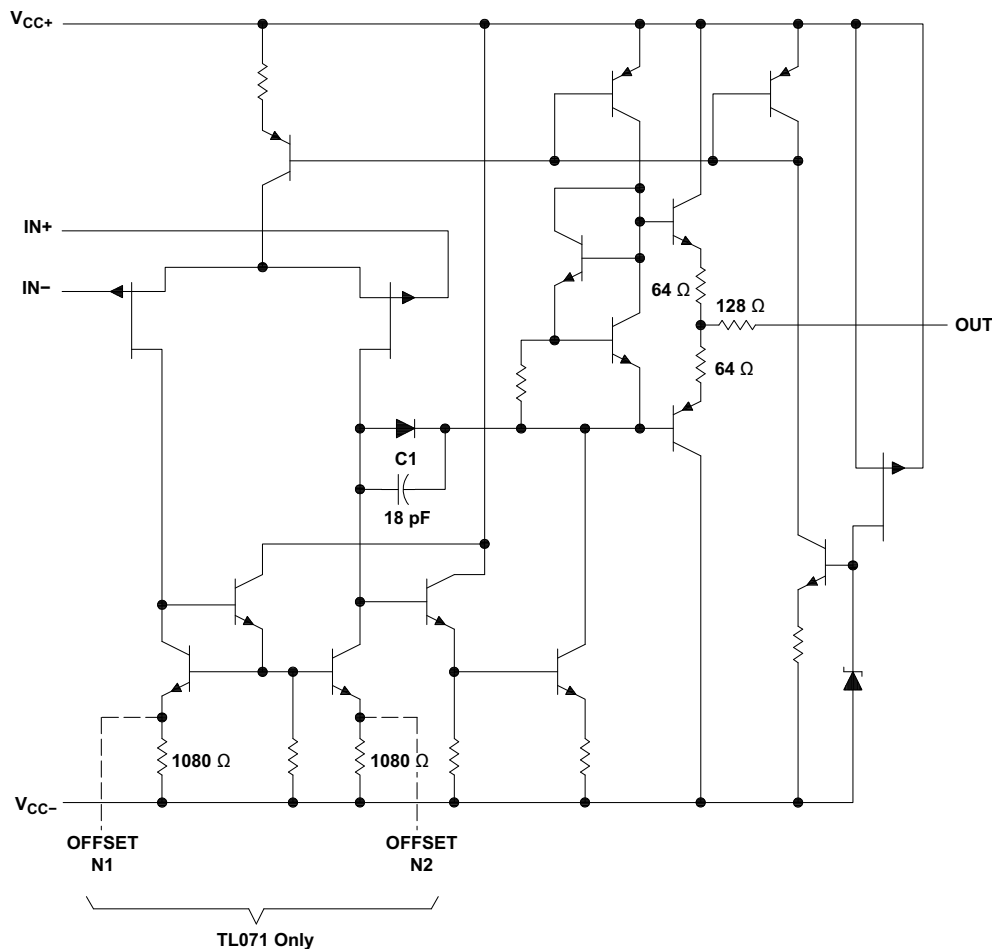
## 8 Detailed Description

### 8.1 Overview

The TL07xH (TL071H, TL072H, and TL074H) family of devices are the next-generation versions of the industry-standard TL07x (TL071, TL072, and TL074) devices. These devices provide outstanding value for cost-sensitive applications, with features including low offset (1 mV, typ), high slew rate (25 V/μs, typ), and common-mode input to the positive supply. High ESD (1.5 kV, HBM), integrated EMI and RF filters, and operation across the full –40°C to 125°C enable the TL07xH devices to be used in the most rugged and demanding applications.

The C-suffix devices are characterized for operation from 0°C to 70°C. The I-suffix devices are characterized for operation from –40°C to +85°C. The M-suffix devices are characterized for operation over the full military temperature range of –55°C to +125°C.

### 8.2 Functional Block Diagram



All component values shown are nominal.

COMPONENT COUNT†			
COMPONENT TYPE	TL071	TL072	TL074
Resistors	11	22	44
Transistors	14	28	56
JFET	2	4	6
Diodes	1	2	4
Capacitors	1	2	4
epi-FET	1	2	4

† Includes bias and trim circuitry

## 8.3 Feature Description

The TL07xH family of devices improve many specifications as compared to the industry-standard TL07x family. Several comparisons of key specifications between these families are included below to show the advantages of the TL07xH family.

### 8.3.1 Total Harmonic Distortion

Harmonic distortions to an audio signal are created by electronic components in a circuit. Total harmonic distortion (THD) is a measure of harmonic distortions accumulated by a signal in an audio system. These devices have a very low THD of 0.003% meaning that the TL07x device adds little harmonic distortion when used in audio signal applications.

### 8.3.2 Slew Rate

The slew rate is the rate at which an operational amplifier can change the output when there is a change on the input. These devices have a 13-V/ $\mu$ s slew rate.

## 8.4 Device Functional Modes

These devices are powered on when the supply is connected. These devices can be operated as a single-supply operational amplifier or dual-supply amplifier depending on the application.

## 9 Application and Implementation

### Note

Information in the following applications sections is not part of the TI component specification, and TI does not warrant its accuracy or completeness. TI's customers are responsible for determining suitability of components for their purposes. Customers should validate and test their design implementation to confirm system functionality.

### 9.1 Application Information

A typical application for an operational amplifier is an inverting amplifier. This amplifier takes a positive voltage on the input, and makes the voltage a negative voltage. In the same manner, the amplifier makes negative voltages positive.

### 9.2 Typical Application

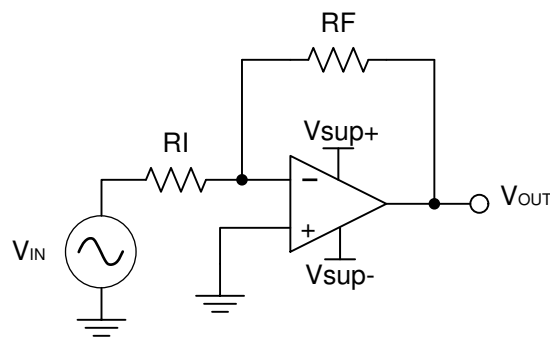


Figure 9-1. Inverting Amplifier

#### 9.2.1 Design Requirements

The supply voltage must be selected so the supply voltage is larger than the input voltage range and output range. For instance, this application scales a signal of  $\pm 0.5$  V to  $\pm 1.8$  V. Setting the supply at  $\pm 12$  V is sufficient to accommodate this application.

#### 9.2.2 Detailed Design Procedure

$$V_o = (V_i + V_{i_o}) * \left(1 + \frac{1 \text{ M}\Omega}{1 \text{ k}\Omega}\right) \quad (1)$$

Determine the gain required by the inverting amplifier:

$$A_v = \frac{V_{OUT}}{V_{IN}} \quad (2)$$

$$A_v = \frac{1.8}{-0.5} = -3.6 \quad (3)$$

Once the desired gain is determined, select a value for  $R_I$  or  $R_F$ . Selecting a value in the kilohm range is desirable because the amplifier circuit uses currents in the milliamp range. This ensures the part does not draw too much current. This example uses  $10 \text{ k}\Omega$  for  $R_I$  which means  $36 \text{ k}\Omega$  is used for  $R_F$ . This is determined by Equation 4.

$$A_v = -\frac{R_F}{R_I} \quad (4)$$



### 9.2.3 Application Curve

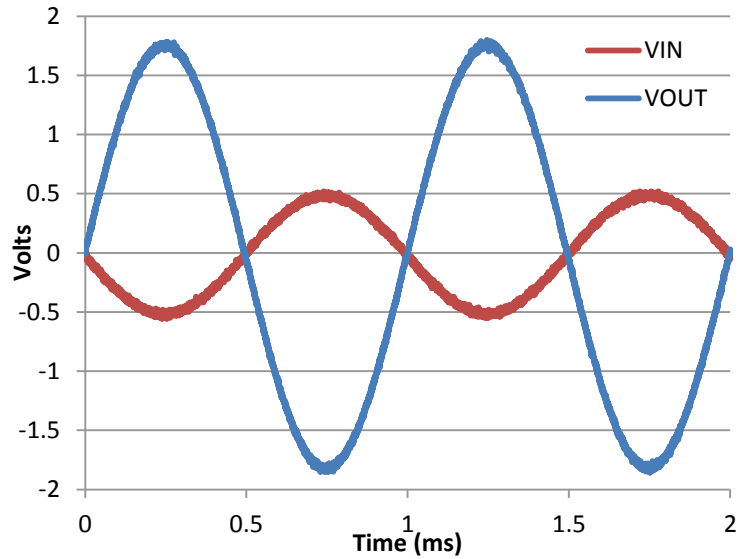
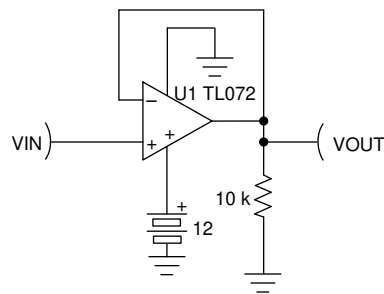


Figure 9-2. Input and Output Voltages of the Inverting Amplifier

### 9.3 Unity Gain Buffer



Copyright © 2017, Texas Instruments Incorporated

Figure 9-3. Single-Supply Unity Gain Amplifier

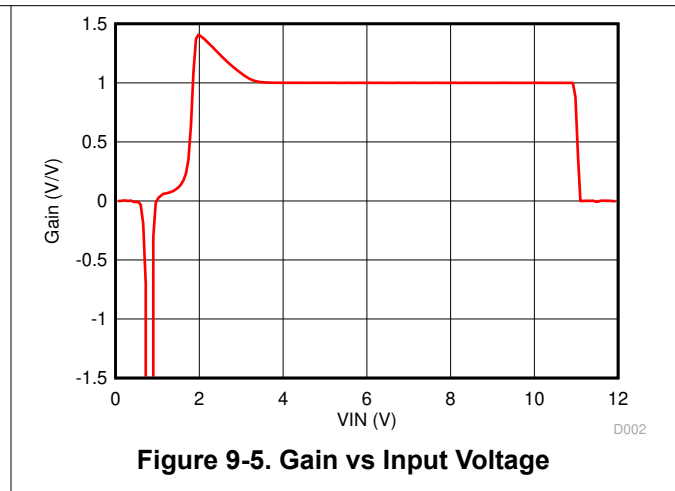
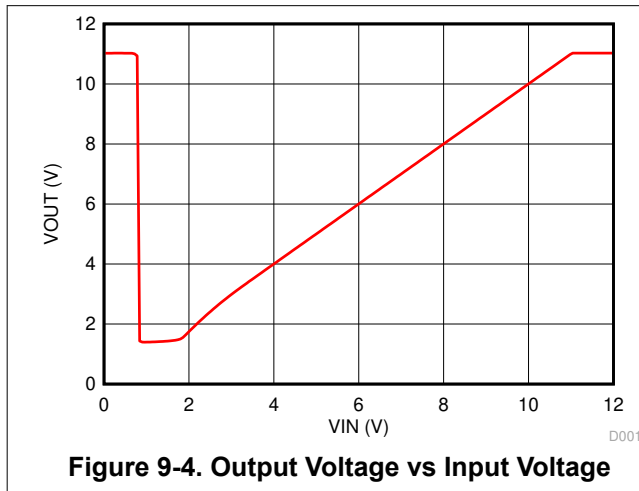
#### 9.3.1 Design Requirements

- $V_{CC}$  must be within valid range per [Section 6.6](#). This example uses a value of 12 V for  $V_{CC}$ .
- Input voltage must be within the recommended common-mode range, as shown in [Section 6.6](#). The valid common-mode range is 4 V to 12 V ( $V_{CC-} + 4$  V to  $V_{CC+}$ ).
- Output is limited by output range, which is typically 1.5 V to 10.5 V, or  $V_{CC-} + 1.5$  V to  $V_{CC+} - 1.5$  V.

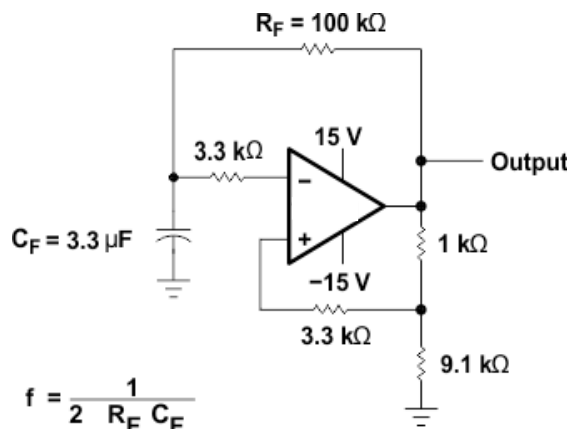
#### 9.3.2 Detailed Design Procedure

- Avoid input voltage values below 1 V to prevent phase reversal where output goes high.
- Avoid input values below 4 V to prevent degraded  $V_{IO}$  that results in an apparent gain greater than 1. This may cause instability in some second-order filter designs.

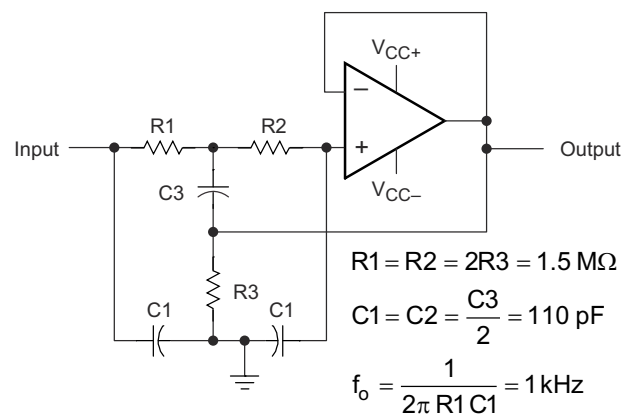
### 9.3.3 Application Curves



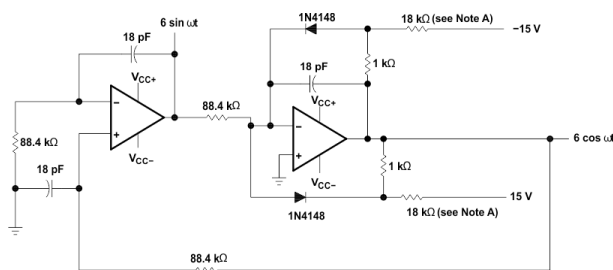
### 9.4 System Examples



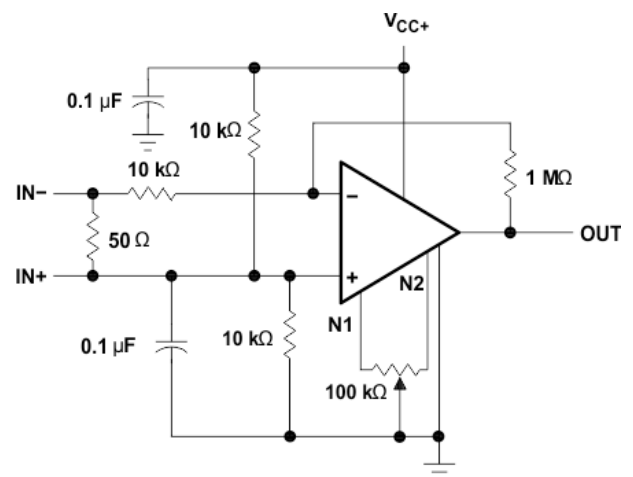
**Figure 9-6. 0.5-Hz Square-Wave Oscillator**



**Figure 9-7. High-Q Notch Filter**



**Figure 9-8. 100-kHz Quadrature Oscillator**



**Figure 9-9. AC Amplifier**

## 10 Power Supply Recommendations

### CAUTION

Supply voltages larger than 36 V for a single-supply or outside the range of  $\pm 18$  V for a dual-supply can permanently damage the device (see [Section 6.2](#)).

Place 0.1- $\mu$ F bypass capacitors close to the power-supply pins to reduce errors coupling in from noisy or high-impedance power supplies. For more detailed information on bypass capacitor placement, see [Section 11](#).

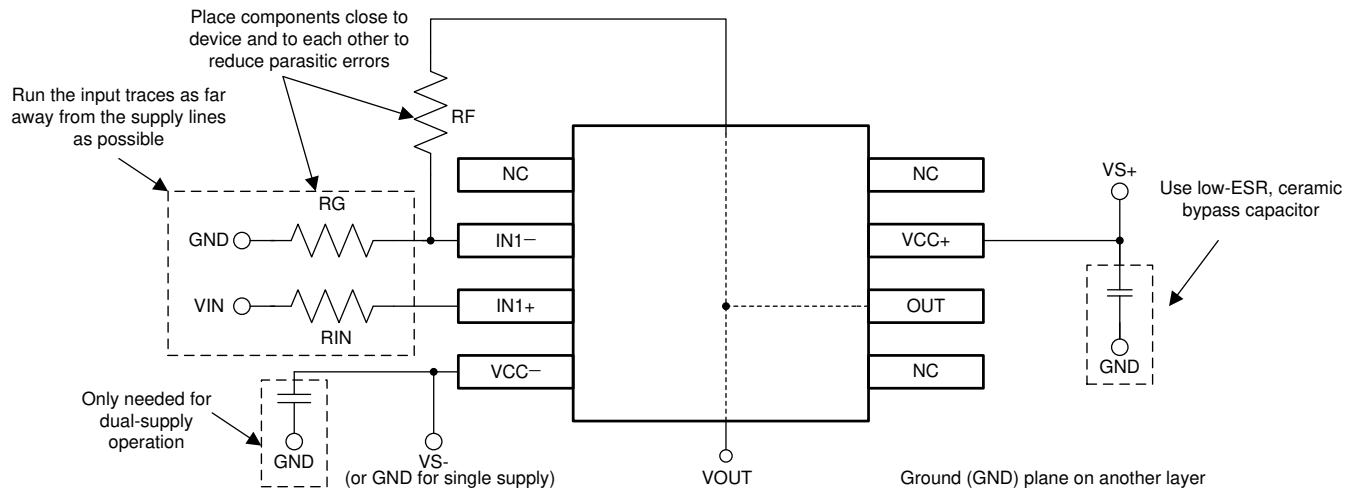
## 11 Layout

### 11.1 Layout Guidelines

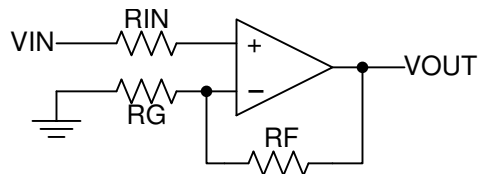
For best operational performance of the device, use good PCB layout practices, including:

- Noise can propagate into analog circuitry through the power pins of the circuit as a whole, as well as the operational amplifier. Bypass capacitors are used to reduce the coupled noise by providing low impedance power sources local to the analog circuitry.
  - Connect low-ESR, 0.1- $\mu$ F ceramic bypass capacitors between each supply pin and ground, placed as close to the device as possible. A single bypass capacitor from  $V_{CC+}$  to ground is applicable for single-supply applications.
- Separate grounding for analog and digital portions of circuitry is one of the simplest and most-effective methods of noise suppression. One or more layers on multilayer PCBs are usually devoted to ground planes. A ground plane helps distribute heat and reduces EMI noise pickup. Take care to physically separate digital and analog grounds, paying attention to the flow of the ground current.
- To reduce parasitic coupling, run the input traces as far away from the supply or output traces as possible. If it is not possible to keep them separate, it is much better to cross the sensitive trace perpendicular as opposed to in parallel with the noisy trace.
- Place the external components as close to the device as possible. Keeping RF and RG close to the inverting input minimizes parasitic capacitance, as shown in [Section 11.2](#).
- Keep the length of input traces as short as possible. Always remember that the input traces are the most sensitive part of the circuit.
- Consider a driven, low-impedance guard ring around the critical traces. A guard ring can significantly reduce leakage currents from nearby traces that are at different potentials.

## 11.2 Layout Example



**Figure 11-1. Operational Amplifier Board Layout for Noninverting Configuration**



**Figure 11-2. Operational Amplifier Schematic for Noninverting Configuration**

## 12 Device and Documentation Support

### 12.1 Related Links

The table below lists quick access links. Categories include technical documents, support and community resources, tools and software, and quick access to sample or buy.

**Table 12-1. Related Links**

PARTS	PRODUCT FOLDER	ORDER NOW	TECHNICAL DOCUMENTS	TOOLS & SOFTWARE	SUPPORT & COMMUNITY
TL071	<a href="#">Click here</a>	<a href="#">Click here</a>	<a href="#">Click here</a>	<a href="#">Click here</a>	<a href="#">Click here</a>
TL071A	<a href="#">Click here</a>	<a href="#">Click here</a>	<a href="#">Click here</a>	<a href="#">Click here</a>	<a href="#">Click here</a>
TL071B	<a href="#">Click here</a>	<a href="#">Click here</a>	<a href="#">Click here</a>	<a href="#">Click here</a>	<a href="#">Click here</a>
TL072	<a href="#">Click here</a>	<a href="#">Click here</a>	<a href="#">Click here</a>	<a href="#">Click here</a>	<a href="#">Click here</a>
TL072A	<a href="#">Click here</a>	<a href="#">Click here</a>	<a href="#">Click here</a>	<a href="#">Click here</a>	<a href="#">Click here</a>
TL072B	<a href="#">Click here</a>	<a href="#">Click here</a>	<a href="#">Click here</a>	<a href="#">Click here</a>	<a href="#">Click here</a>
TL072M	<a href="#">Click here</a>	<a href="#">Click here</a>	<a href="#">Click here</a>	<a href="#">Click here</a>	<a href="#">Click here</a>
TL074	<a href="#">Click here</a>	<a href="#">Click here</a>	<a href="#">Click here</a>	<a href="#">Click here</a>	<a href="#">Click here</a>
TL074A	<a href="#">Click here</a>	<a href="#">Click here</a>	<a href="#">Click here</a>	<a href="#">Click here</a>	<a href="#">Click here</a>
TL074B	<a href="#">Click here</a>	<a href="#">Click here</a>	<a href="#">Click here</a>	<a href="#">Click here</a>	<a href="#">Click here</a>
TL074M	<a href="#">Click here</a>	<a href="#">Click here</a>	<a href="#">Click here</a>	<a href="#">Click here</a>	<a href="#">Click here</a>

### 12.2 Receiving Notification of Documentation Updates

To receive notification of documentation updates, navigate to the device product folder on [ti.com](#). Click on *Subscribe to updates* to register and receive a weekly digest of any product information that has changed. For change details, review the revision history included in any revised document.

### 12.3 Support Resources

[TI E2E™ support forums](#) are an engineer's go-to source for fast, verified answers and design help — straight from the experts. Search existing answers or ask your own question to get the quick design help you need.

Linked content is provided "AS IS" by the respective contributors. They do not constitute TI specifications and do not necessarily reflect TI's views; see TI's [Terms of Use](#).

### 12.4 Trademarks

TI E2E™ is a trademark of Texas Instruments.  
All trademarks are the property of their respective owners.

### 12.5 Electrostatic Discharge Caution



This integrated circuit can be damaged by ESD. Texas Instruments recommends that all integrated circuits be handled with appropriate precautions. Failure to observe proper handling and installation procedures can cause damage.

ESD damage can range from subtle performance degradation to complete device failure. Precision integrated circuits may be more susceptible to damage because very small parametric changes could cause the device not to meet its published specifications.

### 12.6 Glossary

[TI Glossary](#) This glossary lists and explains terms, acronyms, and definitions.

## 13 Mechanical, Packaging, and Orderable Information

The following pages include mechanical packaging and orderable information. This information is the most current data available for the designated devices. This data is subject to change without notice and revision of this document. For browser based versions of this data sheet, refer to the left hand navigation.

**PACKAGING INFORMATION**

Orderable Device	Status (1)	Package Type	Package Drawing	Pins	Package Qty	Eco Plan (2)	Lead finish/ Ball material (6)	MSL Peak Temp (3)	Op Temp (°C)	Device Marking (4/5)	Samples
81023052A	ACTIVE	LCCC	FK	20	1	Non-RoHS & Green	POST-PLATE	N / A for Pkg Type	-55 to 125	81023052A TL072MFKB	<a href="#">Samples</a>
8102305HA	ACTIVE	CFP	U	10	1	Non-RoHS & Green	SNPB	N / A for Pkg Type	-55 to 125	8102305HA TL072M	<a href="#">Samples</a>
8102305PA	ACTIVE	CDIP	JG	8	1	Non-RoHS & Green	SNPB	N / A for Pkg Type	-55 to 125	8102305PA TL072M	<a href="#">Samples</a>
81023062A	ACTIVE	LCCC	FK	20	1	Non-RoHS & Green	POST-PLATE	N / A for Pkg Type	-55 to 125	81023062A TL074MFKB	<a href="#">Samples</a>
8102306CA	ACTIVE	CDIP	J	14	1	Non-RoHS & Green	SNPB	N / A for Pkg Type	-55 to 125	8102306CA TL074MJB	<a href="#">Samples</a>
8102306DA	ACTIVE	CFP	W	14	1	Non-RoHS & Green	SNPB	N / A for Pkg Type	-55 to 125	8102306DA TL074MWB	<a href="#">Samples</a>
JM38510/11905BPA	ACTIVE	CDIP	JG	8	1	Non-RoHS & Green	SNPB	N / A for Pkg Type	-55 to 125	JM38510 /11905BPA	<a href="#">Samples</a>
M38510/11905BPA	ACTIVE	CDIP	JG	8	1	Non-RoHS & Green	SNPB	N / A for Pkg Type	-55 to 125	JM38510 /11905BPA	<a href="#">Samples</a>
TL071ACD	ACTIVE	SOIC	D	8	75	RoHS & Green	NIPDAU	Level-1-260C-UNLIM	0 to 70	071AC	<a href="#">Samples</a>
TL071ACDG4	ACTIVE	SOIC	D	8	75	RoHS & Green	NIPDAU	Level-1-260C-UNLIM	0 to 70	071AC	<a href="#">Samples</a>
TL071ACDR	ACTIVE	SOIC	D	8	2500	RoHS & Green	NIPDAU	Level-1-260C-UNLIM	0 to 70	071AC	<a href="#">Samples</a>
TL071ACP	ACTIVE	PDIP	P	8	50	RoHS & Green	NIPDAU	N / A for Pkg Type	0 to 70	TL071ACP	<a href="#">Samples</a>
TL071BCD	ACTIVE	SOIC	D	8	75	RoHS & Green	NIPDAU	Level-1-260C-UNLIM	0 to 70	071BC	<a href="#">Samples</a>
TL071BCDR	ACTIVE	SOIC	D	8	2500	RoHS & Green	NIPDAU	Level-1-260C-UNLIM	0 to 70	071BC	<a href="#">Samples</a>
TL071BCP	ACTIVE	PDIP	P	8	50	RoHS & Green	NIPDAU	N / A for Pkg Type	0 to 70	TL071BCP	<a href="#">Samples</a>
TL071CD	ACTIVE	SOIC	D	8	75	RoHS & Green	NIPDAU	Level-1-260C-UNLIM	0 to 70	TL071C	<a href="#">Samples</a>
TL071CDR	ACTIVE	SOIC	D	8	2500	RoHS & Green	NIPDAU	Level-1-260C-UNLIM	0 to 70	TL071C	<a href="#">Samples</a>
TL071CDRE4	ACTIVE	SOIC	D	8	2500	RoHS & Green	NIPDAU	Level-1-260C-UNLIM	0 to 70	TL071C	<a href="#">Samples</a>

Orderable Device	Status (1)	Package Type	Package Drawing	Pins	Package Qty	Eco Plan (2)	Lead finish/ Ball material (6)	MSL Peak Temp (3)	Op Temp (°C)	Device Marking (4/5)	Samples
TL071CDRG4	ACTIVE	SOIC	D	8	2500	RoHS & Green	NIPDAU	Level-1-260C-UNLIM	0 to 70	TL071C	<a href="#">Samples</a>
TL071CP	ACTIVE	PDIP	P	8	50	RoHS & Green	NIPDAU	N / A for Pkg Type	0 to 70	TL071CP	<a href="#">Samples</a>
TL071CPE4	ACTIVE	PDIP	P	8	50	RoHS & Green	NIPDAU	N / A for Pkg Type	0 to 70	TL071CP	<a href="#">Samples</a>
TL071CPSR	ACTIVE	SO	PS	8	2000	RoHS & Green	NIPDAU	Level-1-260C-UNLIM	0 to 70	T071	<a href="#">Samples</a>
TL071ID	ACTIVE	SOIC	D	8	75	RoHS & Green	NIPDAU	Level-1-260C-UNLIM	-40 to 85	TL071I	<a href="#">Samples</a>
TL071IDR	ACTIVE	SOIC	D	8	2500	RoHS & Green	NIPDAU	Level-1-260C-UNLIM	-40 to 85	TL071I	<a href="#">Samples</a>
TL071IDRG4	ACTIVE	SOIC	D	8	2500	RoHS & Green	NIPDAU	Level-1-260C-UNLIM	-40 to 85	TL071I	<a href="#">Samples</a>
TL071IP	ACTIVE	PDIP	P	8	50	RoHS & Green	NIPDAU	N / A for Pkg Type	-40 to 85	TL071IP	<a href="#">Samples</a>
TL072ACD	ACTIVE	SOIC	D	8	75	RoHS & Green	NIPDAU	Level-1-260C-UNLIM	0 to 70	072AC	<a href="#">Samples</a>
TL072ACDE4	ACTIVE	SOIC	D	8	75	RoHS & Green	NIPDAU	Level-1-260C-UNLIM	0 to 70	072AC	<a href="#">Samples</a>
TL072ACDR	ACTIVE	SOIC	D	8	2500	RoHS & Green	NIPDAU	Level-1-260C-UNLIM	0 to 70	072AC	<a href="#">Samples</a>
TL072ACDRE4	ACTIVE	SOIC	D	8	2500	RoHS & Green	NIPDAU	Level-1-260C-UNLIM	0 to 70	072AC	<a href="#">Samples</a>
TL072ACDRG4	ACTIVE	SOIC	D	8	2500	RoHS & Green	NIPDAU	Level-1-260C-UNLIM	0 to 70	072AC	<a href="#">Samples</a>
TL072ACP	ACTIVE	PDIP	P	8	50	RoHS & Green	NIPDAU	N / A for Pkg Type	0 to 70	TL072ACP	<a href="#">Samples</a>
TL072ACPE4	ACTIVE	PDIP	P	8	50	RoHS & Green	NIPDAU	N / A for Pkg Type	0 to 70	TL072ACP	<a href="#">Samples</a>
TL072BCD	ACTIVE	SOIC	D	8	75	RoHS & Green	NIPDAU	Level-1-260C-UNLIM	0 to 70	072BC	<a href="#">Samples</a>
TL072BCDE4	ACTIVE	SOIC	D	8	75	RoHS & Green	NIPDAU	Level-1-260C-UNLIM	0 to 70	072BC	<a href="#">Samples</a>
TL072BCDG4	ACTIVE	SOIC	D	8	75	RoHS & Green	NIPDAU	Level-1-260C-UNLIM	0 to 70	072BC	<a href="#">Samples</a>
TL072BCDR	ACTIVE	SOIC	D	8	2500	RoHS & Green	NIPDAU	Level-1-260C-UNLIM	0 to 70	072BC	<a href="#">Samples</a>
TL072BCDRG4	ACTIVE	SOIC	D	8	2500	RoHS & Green	NIPDAU	Level-1-260C-UNLIM	0 to 70	072BC	<a href="#">Samples</a>
TL072BCP	ACTIVE	PDIP	P	8	50	RoHS & Green	NIPDAU	N / A for Pkg Type	0 to 70	TL072BCP	<a href="#">Samples</a>

Orderable Device	Status (1)	Package Type	Package Drawing	Pins	Package Qty	Eco Plan (2)	Lead finish/ Ball material (6)	MSL Peak Temp (3)	Op Temp (°C)	Device Marking (4/5)	Samples
TL072BCPE4	ACTIVE	PDIP	P	8	50	RoHS & Green	NIPDAU	N / A for Pkg Type	0 to 70	TL072BCP	<a href="#">Samples</a>
TL072CD	ACTIVE	SOIC	D	8	75	RoHS & Green	NIPDAU	Level-1-260C-UNLIM	0 to 70	TL072C	<a href="#">Samples</a>
TL072CDE4	ACTIVE	SOIC	D	8	75	RoHS & Green	NIPDAU	Level-1-260C-UNLIM	0 to 70	TL072C	<a href="#">Samples</a>
TL072CDG4	ACTIVE	SOIC	D	8	75	RoHS & Green	NIPDAU	Level-1-260C-UNLIM	0 to 70	TL072C	<a href="#">Samples</a>
TL072CDR	ACTIVE	SOIC	D	8	2500	RoHS & Green	NIPDAU	Level-1-260C-UNLIM	0 to 70	TL072C	<a href="#">Samples</a>
TL072CDRE4	ACTIVE	SOIC	D	8	2500	RoHS & Green	NIPDAU	Level-1-260C-UNLIM	0 to 70	TL072C	<a href="#">Samples</a>
TL072CDRG4	ACTIVE	SOIC	D	8	2500	RoHS & Green	NIPDAU	Level-1-260C-UNLIM	0 to 70	TL072C	<a href="#">Samples</a>
TL072CP	ACTIVE	PDIP	P	8	50	RoHS & Green	NIPDAU	N / A for Pkg Type	0 to 70	TL072CP	<a href="#">Samples</a>
TL072CPE4	ACTIVE	PDIP	P	8	50	RoHS & Green	NIPDAU	N / A for Pkg Type	0 to 70	TL072CP	<a href="#">Samples</a>
TL072CPS	ACTIVE	SO	PS	8	80	RoHS & Green	NIPDAU	Level-1-260C-UNLIM	0 to 70	T072	<a href="#">Samples</a>
TL072CPSR	ACTIVE	SO	PS	8	2000	RoHS & Green	NIPDAU	Level-1-260C-UNLIM	0 to 70	T072	<a href="#">Samples</a>
TL072CPSRE4	ACTIVE	SO	PS	8	2000	RoHS & Green	NIPDAU	Level-1-260C-UNLIM	0 to 70	T072	<a href="#">Samples</a>
TL072CPSRG4	ACTIVE	SO	PS	8	2000	RoHS & Green	NIPDAU	Level-1-260C-UNLIM	0 to 70	T072	<a href="#">Samples</a>
TL072CPWR	ACTIVE	TSSOP	PW	8	2000	RoHS & Green	NIPDAU	Level-1-260C-UNLIM	0 to 70	T072	<a href="#">Samples</a>
TL072CPWRE4	ACTIVE	TSSOP	PW	8	2000	RoHS & Green	NIPDAU	Level-1-260C-UNLIM	0 to 70	T072	<a href="#">Samples</a>
TL072CPWRG4	ACTIVE	TSSOP	PW	8	2000	RoHS & Green	NIPDAU	Level-1-260C-UNLIM	0 to 70	T072	<a href="#">Samples</a>
TL072ID	ACTIVE	SOIC	D	8	75	RoHS & Green	NIPDAU	Level-1-260C-UNLIM	-40 to 85	TL072I	<a href="#">Samples</a>
TL072IDE4	ACTIVE	SOIC	D	8	75	RoHS & Green	NIPDAU	Level-1-260C-UNLIM	-40 to 85	TL072I	<a href="#">Samples</a>
TL072IDG4	ACTIVE	SOIC	D	8	75	RoHS & Green	NIPDAU	Level-1-260C-UNLIM	-40 to 85	TL072I	<a href="#">Samples</a>
TL072IDR	ACTIVE	SOIC	D	8	2500	RoHS & Green	NIPDAU	Level-1-260C-UNLIM	-40 to 85	TL072I	<a href="#">Samples</a>
TL072IDRE4	ACTIVE	SOIC	D	8	2500	RoHS & Green	NIPDAU	Level-1-260C-UNLIM	-40 to 85	TL072I	<a href="#">Samples</a>



Orderable Device	Status (1)	Package Type	Package Drawing	Pins	Package Qty	Eco Plan (2)	Lead finish/ Ball material (6)	MSL Peak Temp (3)	Op Temp (°C)	Device Marking (4/5)	Samples
TL072IDRG4	ACTIVE	SOIC	D	8	2500	RoHS & Green	NIPDAU	Level-1-260C-UNLIM	-40 to 85	TL072I	<a href="#">Samples</a>
TL072IP	ACTIVE	PDIP	P	8	50	RoHS & Green	NIPDAU	N / A for Pkg Type	-40 to 85	TL072IP	<a href="#">Samples</a>
TL072IPE4	ACTIVE	PDIP	P	8	50	RoHS & Green	NIPDAU	N / A for Pkg Type	-40 to 85	TL072IP	<a href="#">Samples</a>
TL072MFKB	ACTIVE	LCCC	FK	20	1	Non-RoHS & Green	POST-PLATE	N / A for Pkg Type	-55 to 125	81023052A TL072MFKB	<a href="#">Samples</a>
TL072MJG	ACTIVE	CDIP	JG	8	1	Non-RoHS & Green	SNPB	N / A for Pkg Type	-55 to 125	TL072MJG	<a href="#">Samples</a>
TL072MJGB	ACTIVE	CDIP	JG	8	1	Non-RoHS & Green	SNPB	N / A for Pkg Type	-55 to 125	8102305PA TL072M	<a href="#">Samples</a>
TL072MUB	ACTIVE	CFP	U	10	1	Non-RoHS & Green	SNPB	N / A for Pkg Type	-55 to 125	8102305HA TL072M	<a href="#">Samples</a>
TL074ACD	ACTIVE	SOIC	D	14	50	RoHS & Green	NIPDAU	Level-1-260C-UNLIM	0 to 70	TL074AC	<a href="#">Samples</a>
TL074ACDE4	ACTIVE	SOIC	D	14	50	RoHS & Green	NIPDAU	Level-1-260C-UNLIM	0 to 70	TL074AC	<a href="#">Samples</a>
TL074ACDR	ACTIVE	SOIC	D	14	2500	RoHS & Green	NIPDAU	Level-1-260C-UNLIM	0 to 70	TL074AC	<a href="#">Samples</a>
TL074ACDRE4	ACTIVE	SOIC	D	14	2500	RoHS & Green	NIPDAU	Level-1-260C-UNLIM	0 to 70	TL074AC	<a href="#">Samples</a>
TL074ACDRG4	ACTIVE	SOIC	D	14	2500	RoHS & Green	NIPDAU	Level-1-260C-UNLIM	0 to 70	TL074AC	<a href="#">Samples</a>
TL074ACN	ACTIVE	PDIP	N	14	25	RoHS & Green	NIPDAU	N / A for Pkg Type	0 to 70	TL074ACN	<a href="#">Samples</a>
TL074ACNE4	ACTIVE	PDIP	N	14	25	RoHS & Green	NIPDAU	N / A for Pkg Type	0 to 70	TL074ACN	<a href="#">Samples</a>
TL074ACNSR	ACTIVE	SO	NS	14	2000	RoHS & Green	NIPDAU	Level-1-260C-UNLIM	0 to 70	TL074A	<a href="#">Samples</a>
TL074BCD	ACTIVE	SOIC	D	14	50	RoHS & Green	NIPDAU	Level-1-260C-UNLIM	0 to 70	TL074BC	<a href="#">Samples</a>
TL074BCDE4	ACTIVE	SOIC	D	14	50	RoHS & Green	NIPDAU	Level-1-260C-UNLIM	0 to 70	TL074BC	<a href="#">Samples</a>
TL074BCDR	ACTIVE	SOIC	D	14	2500	RoHS & Green	NIPDAU	Level-1-260C-UNLIM	0 to 70	TL074BC	<a href="#">Samples</a>
TL074BCDRE4	ACTIVE	SOIC	D	14	2500	RoHS & Green	NIPDAU	Level-1-260C-UNLIM	0 to 70	TL074BC	<a href="#">Samples</a>
TL074BCDRG4	ACTIVE	SOIC	D	14	2500	RoHS & Green	NIPDAU	Level-1-260C-UNLIM	0 to 70	TL074BC	<a href="#">Samples</a>

Orderable Device	Status (1)	Package Type	Package Drawing	Pins	Package Qty	Eco Plan (2)	Lead finish/ Ball material (6)	MSL Peak Temp (3)	Op Temp (°C)	Device Marking (4/5)	Samples
TL074BCN	ACTIVE	PDIP	N	14	25	RoHS & Green	NIPDAU	N / A for Pkg Type	0 to 70	TL074BCN	<a href="#">Samples</a>
TL074BCNE4	ACTIVE	PDIP	N	14	25	RoHS & Green	NIPDAU	N / A for Pkg Type	0 to 70	TL074BCN	<a href="#">Samples</a>
TL074CD	ACTIVE	SOIC	D	14	50	RoHS & Green	NIPDAU	Level-1-260C-UNLIM	0 to 70	TL074C	<a href="#">Samples</a>
TL074CDBR	ACTIVE	SSOP	DB	14	2000	RoHS & Green	NIPDAU	Level-1-260C-UNLIM	0 to 70	T074	<a href="#">Samples</a>
TL074CDG4	ACTIVE	SOIC	D	14	50	RoHS & Green	NIPDAU	Level-1-260C-UNLIM	0 to 70	TL074C	<a href="#">Samples</a>
TL074CDR	ACTIVE	SOIC	D	14	2500	RoHS & Green	NIPDAU   SN	Level-1-260C-UNLIM	0 to 70	TL074C	<a href="#">Samples</a>
TL074CDRG4	ACTIVE	SOIC	D	14	2500	RoHS & Green	NIPDAU	Level-1-260C-UNLIM	0 to 70	TL074C	<a href="#">Samples</a>
TL074CN	ACTIVE	PDIP	N	14	25	RoHS & Green	NIPDAU	N / A for Pkg Type	0 to 70	TL074CN	<a href="#">Samples</a>
TL074CNE4	ACTIVE	PDIP	N	14	25	RoHS & Green	NIPDAU	N / A for Pkg Type	0 to 70	TL074CN	<a href="#">Samples</a>
TL074CNSR	ACTIVE	SO	NS	14	2000	RoHS & Green	NIPDAU	Level-1-260C-UNLIM	0 to 70	TL074	<a href="#">Samples</a>
TL074CNSRG4	ACTIVE	SO	NS	14	2000	RoHS & Green	NIPDAU	Level-1-260C-UNLIM	0 to 70	TL074	<a href="#">Samples</a>
TL074CPW	ACTIVE	TSSOP	PW	14	90	RoHS & Green	NIPDAU	Level-1-260C-UNLIM	0 to 70	T074	<a href="#">Samples</a>
TL074CPWR	ACTIVE	TSSOP	PW	14	2000	RoHS & Green	NIPDAU	Level-1-260C-UNLIM	0 to 70	T074	<a href="#">Samples</a>
TL074CPWRE4	ACTIVE	TSSOP	PW	14	2000	RoHS & Green	NIPDAU	Level-1-260C-UNLIM	0 to 70	T074	<a href="#">Samples</a>
TL074CPWRG4	ACTIVE	TSSOP	PW	14	2000	RoHS & Green	NIPDAU	Level-1-260C-UNLIM	0 to 70	T074	<a href="#">Samples</a>
TL074HIDR	ACTIVE	SOIC	D	14	2500	RoHS & Green	NIPDAU	Level-2-260C-1 YEAR	-40 to 125	TL074HID	<a href="#">Samples</a>
TL074HIPWR	ACTIVE	TSSOP	PW	14	2000	RoHS & Green	NIPDAU	Level-2-260C-1 YEAR	-40 to 125	TL074PW	<a href="#">Samples</a>
TL074ID	ACTIVE	SOIC	D	14	50	RoHS & Green	NIPDAU	Level-1-260C-UNLIM	-40 to 85	TL074I	<a href="#">Samples</a>
TL074IDE4	ACTIVE	SOIC	D	14	50	RoHS & Green	NIPDAU	Level-1-260C-UNLIM	-40 to 85	TL074I	<a href="#">Samples</a>
TL074IDG4	ACTIVE	SOIC	D	14	50	RoHS & Green	NIPDAU	Level-1-260C-UNLIM	-40 to 85	TL074I	<a href="#">Samples</a>
TL074IDR	ACTIVE	SOIC	D	14	2500	RoHS & Green	NIPDAU	Level-1-260C-UNLIM	-40 to 85	TL074I	<a href="#">Samples</a>

Orderable Device	Status (1)	Package Type	Package Drawing	Pins	Package Qty	Eco Plan (2)	Lead finish/ Ball material (6)	MSL Peak Temp (3)	Op Temp (°C)	Device Marking (4/5)	Samples
TL074IDRE4	ACTIVE	SOIC	D	14	2500	RoHS & Green	NIPDAU	Level-1-260C-UNLIM	-40 to 85	TL074I	<a href="#">Samples</a>
TL074IDRG4	ACTIVE	SOIC	D	14	2500	RoHS & Green	NIPDAU	Level-1-260C-UNLIM	-40 to 85	TL074I	<a href="#">Samples</a>
TL074IN	ACTIVE	PDIP	N	14	25	RoHS & Green	NIPDAU	N / A for Pkg Type	-40 to 85	TL074IN	<a href="#">Samples</a>
TL074MFK	ACTIVE	LCCC	FK	20	1	Non-RoHS & Green	POST-PLATE	N / A for Pkg Type	-55 to 125	TL074MFK	<a href="#">Samples</a>
TL074MFKB	ACTIVE	LCCC	FK	20	1	Non-RoHS & Green	POST-PLATE	N / A for Pkg Type	-55 to 125	81023062A TL074MFKB	<a href="#">Samples</a>
TL074MJ	ACTIVE	CDIP	J	14	1	Non-RoHS & Green	SNPB	N / A for Pkg Type	-55 to 125	TL074MJ	<a href="#">Samples</a>
TL074MJB	ACTIVE	CDIP	J	14	1	Non-RoHS & Green	SNPB	N / A for Pkg Type	-55 to 125	8102306CA TL074MJB	<a href="#">Samples</a>
TL074MWB	ACTIVE	CFP	W	14	1	Non-RoHS & Green	SNPB	N / A for Pkg Type	-55 to 125	8102306DA TL074MWB	<a href="#">Samples</a>

(1) The marketing status values are defined as follows:

**ACTIVE:** Product device recommended for new designs.

**LIFEBUY:** TI has announced that the device will be discontinued, and a lifetime-buy period is in effect.

**NRND:** Not recommended for new designs. Device is in production to support existing customers, but TI does not recommend using this part in a new design.

**PREVIEW:** Device has been announced but is not in production. Samples may or may not be available.

**OBSOLETE:** TI has discontinued the production of the device.

(2) **RoHS:** TI defines "RoHS" to mean semiconductor products that are compliant with the current EU RoHS requirements for all 10 RoHS substances, including the requirement that RoHS substance do not exceed 0.1% by weight in homogeneous materials. Where designed to be soldered at high temperatures, "RoHS" products are suitable for use in specified lead-free processes. TI may reference these types of products as "Pb-Free".

**RoHS Exempt:** TI defines "RoHS Exempt" to mean products that contain lead but are compliant with EU RoHS pursuant to a specific EU RoHS exemption.

**Green:** TI defines "Green" to mean the content of Chlorine (Cl) and Bromine (Br) based flame retardants meet JS709B low halogen requirements of <=1000ppm threshold. Antimony trioxide based flame retardants must also meet the <=1000ppm threshold requirement.

(3) MSL, Peak Temp. - The Moisture Sensitivity Level rating according to the JEDEC industry standard classifications, and peak solder temperature.

(4) There may be additional marking, which relates to the logo, the lot trace code information, or the environmental category on the device.

(5) Multiple Device Markings will be inside parentheses. Only one Device Marking contained in parentheses and separated by a "-" will appear on a device. If a line is indented then it is a continuation of the previous line and the two combined represent the entire Device Marking for that device.

<sup>(6)</sup> Lead finish/Ball material - Orderable Devices may have multiple material finish options. Finish options are separated by a vertical ruled line. Lead finish/Ball material values may wrap to two lines if the finish value exceeds the maximum column width.

**Important Information and Disclaimer:**The information provided on this page represents TI's knowledge and belief as of the date that it is provided. TI bases its knowledge and belief on information provided by third parties, and makes no representation or warranty as to the accuracy of such information. Efforts are underway to better integrate information from third parties. TI has taken and continues to take reasonable steps to provide representative and accurate information but may not have conducted destructive testing or chemical analysis on incoming materials and chemicals. TI and TI suppliers consider certain information to be proprietary, and thus CAS numbers and other limited information may not be available for release.

In no event shall TI's liability arising out of such information exceed the total purchase price of the TI part(s) at issue in this document sold by TI to Customer on an annual basis.

**OTHER QUALIFIED VERSIONS OF TL072, TL072M, TL074, TL074M :**

- Catalog: [TL072](#), [TL074](#)
- Enhanced Product: [TL072-EP](#), [TL072-EP](#), [TL074-EP](#), [TL074-EP](#)
- Military: [TL072M](#), [TL074M](#)

NOTE: Qualified Version Definitions:

- Catalog - TI's standard catalog product
- Enhanced Product - Supports Defense, Aerospace and Medical Applications
- Military - QML certified for Military and Defense Applications

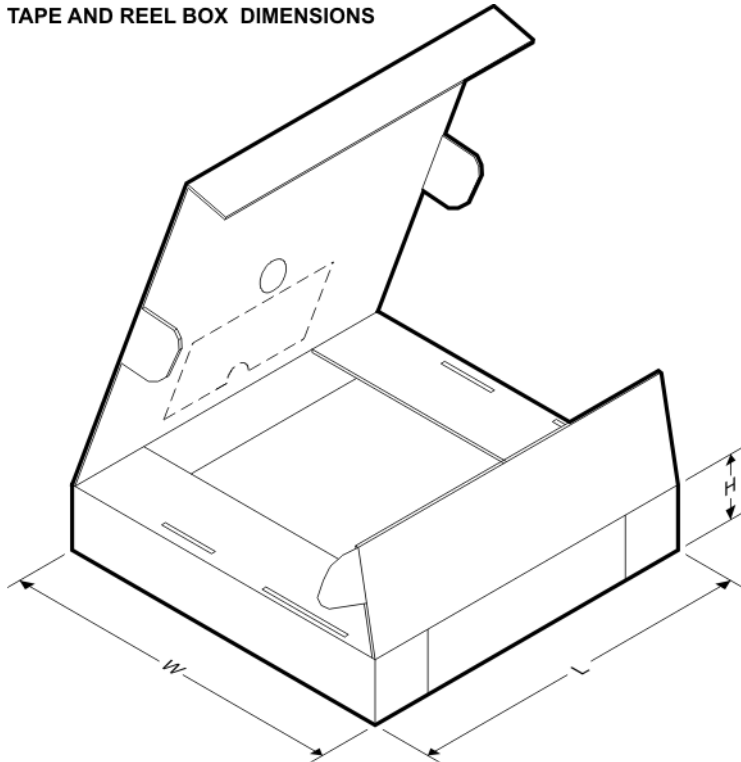
**TAPE AND REEL INFORMATION**

**QUADRANT ASSIGNMENTS FOR PIN 1 ORIENTATION IN TAPE**


\*All dimensions are nominal

Device	Package Type	Package Drawing	Pins	SPQ	Reel Diameter (mm)	Reel Width W1 (mm)	A0 (mm)	B0 (mm)	K0 (mm)	P1 (mm)	W (mm)	Pin1 Quadrant
TL071ACDR	SOIC	D	8	2500	330.0	12.4	6.4	5.2	2.1	8.0	12.0	Q1
TL071BCDR	SOIC	D	8	2500	330.0	12.4	6.4	5.2	2.1	8.0	12.0	Q1
TL071CDR	SOIC	D	8	2500	330.0	12.4	6.4	5.2	2.1	8.0	12.0	Q1
TL071CDR	SOIC	D	8	2500	330.0	12.4	6.4	5.2	2.1	8.0	12.0	Q1
TL071IDR	SOIC	D	8	2500	330.0	12.4	6.4	5.2	2.1	8.0	12.0	Q1
TL072ACDR	SOIC	D	8	2500	330.0	12.4	6.4	5.2	2.1	8.0	12.0	Q1
TL072BCDR	SOIC	D	8	2500	330.0	12.4	6.4	5.2	2.1	8.0	12.0	Q1
TL072CDR	SOIC	D	8	2500	330.0	12.4	6.4	5.2	2.1	8.0	12.0	Q1
TL072CDR	SOIC	D	8	2500	330.0	12.4	6.4	5.2	2.1	8.0	12.0	Q1
TL072CPWR	TSSOP	PW	8	2000	330.0	12.4	7.0	3.6	1.6	8.0	12.0	Q1
TL072IDR	SOIC	D	8	2500	330.0	12.4	6.4	5.2	2.1	8.0	12.0	Q1
TL072IDR	SOIC	D	8	2500	330.0	12.4	6.4	5.2	2.1	8.0	12.0	Q1
TL074ACDR	SOIC	D	14	2500	330.0	16.4	6.5	9.0	2.1	8.0	16.0	Q1
TL074ACNSR	SO	NS	14	2000	330.0	16.4	8.2	10.5	2.5	12.0	16.0	Q1
TL074BCDR	SOIC	D	14	2500	330.0	16.4	6.5	9.0	2.1	8.0	16.0	Q1
TL074CDR	SOIC	D	14	2500	330.0	16.4	6.5	9.0	2.1	8.0	16.0	Q1
TL074CDRG4	SOIC	D	14	2500	330.0	16.4	6.5	9.0	2.1	8.0	16.0	Q1
TL074CNSR	SO	NS	14	2000	330.0	16.4	8.2	10.5	2.5	12.0	16.0	Q1

Device	Package Type	Package Drawing	Pins	SPQ	Reel Diameter (mm)	Reel Width W1 (mm)	A0 (mm)	B0 (mm)	K0 (mm)	P1 (mm)	W (mm)	Pin1 Quadrant
TL074CPWR	TSSOP	PW	14	2000	330.0	12.4	6.9	5.6	1.6	8.0	12.0	Q1
TL074HIDR	SOIC	D	14	2500	330.0	16.4	6.5	9.0	2.1	8.0	16.0	Q1
TL074HIPWR	TSSOP	PW	14	2000	330.0	12.4	6.9	5.6	1.6	8.0	12.0	Q1
TL074IDR	SOIC	D	14	2500	330.0	16.4	6.5	9.0	2.1	8.0	16.0	Q1

**TAPE AND REEL BOX DIMENSIONS**


\*All dimensions are nominal

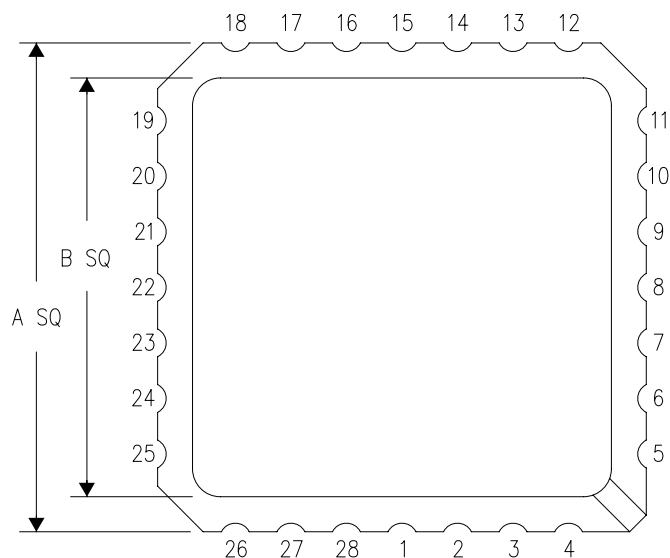
Device	Package Type	Package Drawing	Pins	SPQ	Length (mm)	Width (mm)	Height (mm)
TL071ACDR	SOIC	D	8	2500	340.5	338.1	20.6
TL071BCDR	SOIC	D	8	2500	340.5	338.1	20.6
TL071CDR	SOIC	D	8	2500	340.5	338.1	20.6
TL071CDR	SOIC	D	8	2500	853.0	449.0	35.0
TL071IDR	SOIC	D	8	2500	340.5	338.1	20.6
TL072ACDR	SOIC	D	8	2500	340.5	338.1	20.6
TL072BCDR	SOIC	D	8	2500	340.5	338.1	20.6
TL072CDR	SOIC	D	8	2500	853.0	449.0	35.0
TL072CDR	SOIC	D	8	2500	340.5	338.1	20.6
TL072CPWR	TSSOP	PW	8	2000	853.0	449.0	35.0
TL072IDR	SOIC	D	8	2500	853.0	449.0	35.0
TL072IDR	SOIC	D	8	2500	340.5	338.1	20.6
TL074ACDR	SOIC	D	14	2500	333.2	345.9	28.6

Device	Package Type	Package Drawing	Pins	SPQ	Length (mm)	Width (mm)	Height (mm)
TL074ACNSR	SO	NS	14	2000	853.0	449.0	35.0
TL074BCDR	SOIC	D	14	2500	333.2	345.9	28.6
TL074CDR	SOIC	D	14	2500	333.2	345.9	28.6
TL074CDRG4	SOIC	D	14	2500	333.2	345.9	28.6
TL074CNSR	SO	NS	14	2000	853.0	449.0	35.0
TL074CPWR	TSSOP	PW	14	2000	853.0	449.0	35.0
TL074HIDR	SOIC	D	14	2500	853.0	449.0	35.0
TL074HIPWR	TSSOP	PW	14	2000	853.0	449.0	35.0
TL074IDR	SOIC	D	14	2500	333.2	345.9	28.6

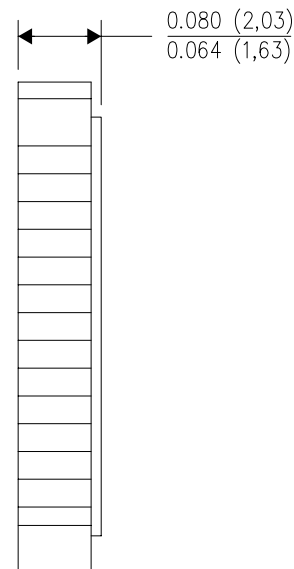
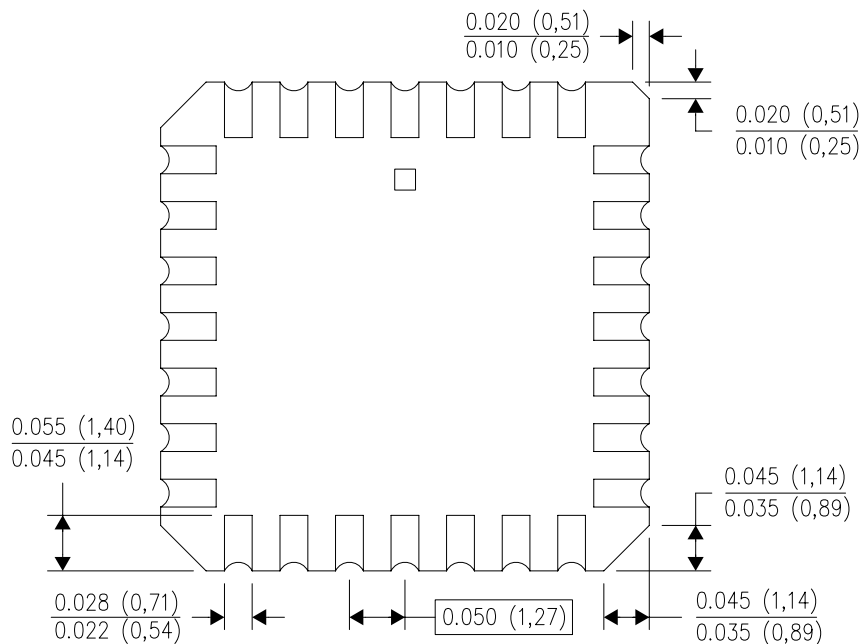
FK (S-CQCC-N\*\*)

LEADLESS CERAMIC CHIP CARRIER

28 TERMINAL SHOWN



NO. OF TERMINALS **	A		B	
	MIN	MAX	MIN	MAX
20	0.342 (8,69)	0.358 (9,09)	0.307 (7,80)	0.358 (9,09)
28	0.442 (11,23)	0.458 (11,63)	0.406 (10,31)	0.458 (11,63)
44	0.640 (16,26)	0.660 (16,76)	0.495 (12,58)	0.560 (14,22)
52	0.740 (18,78)	0.761 (19,32)	0.495 (12,58)	0.560 (14,22)
68	0.938 (23,83)	0.962 (24,43)	0.850 (21,6)	0.858 (21,8)
84	1.141 (28,99)	1.165 (29,59)	1.047 (26,6)	1.063 (27,0)



4040140/D 01/11

- NOTES:
- A. All linear dimensions are in inches (millimeters).
  - B. This drawing is subject to change without notice.
  - C. This package can be hermetically sealed with a metal lid.
  - D. Falls within JEDEC MS-004



# MECHANICAL DATA

NS (R-PDSO-G\*\*)

PLASTIC SMALL-OUTLINE PACKAGE

14-PINS SHOWN



- NOTES:
- A. All linear dimensions are in millimeters.
  - B. This drawing is subject to change without notice.
  - C. Body dimensions do not include mold flash or protrusion, not to exceed 0,15.

W (R-GDFP-F14)

CERAMIC DUAL FLATPACK



- NOTES:
- A. All linear dimensions are in inches (millimeters).
  - B. This drawing is subject to change without notice.
  - C. This package can be hermetically sealed with a ceramic lid using glass frit.
  - D. Index point is provided on cap for terminal identification only.
  - E. Falls within MIL STD 1835 GDFP1-F14

J 14

**GENERIC PACKAGE VIEW**  
**CDIP - 5.08 mm max height**  
CERAMIC DUAL IN LINE PACKAGE



Images above are just a representation of the package family, actual package may vary.  
Refer to the product data sheet for package details.

4040083-5/G

J0014A



# PACKAGE OUTLINE

CDIP - 5.08 mm max height

CERAMIC DUAL IN LINE PACKAGE



4214771/A 05/2017

NOTES:

1. All controlling linear dimensions are in inches. Dimensions in brackets are in millimeters. Any dimension in brackets or parenthesis are for reference only. Dimensioning and tolerancing per ASME Y14.5M.
2. This drawing is subject to change without notice.
3. This package is hermetically sealed with a ceramic lid using glass frit.
4. Index point is provided on cap for terminal identification only and on press ceramic glass frit seal only.
5. Falls within MIL-STD-1835 and GDIP1-T14.

# EXAMPLE BOARD LAYOUT

J0014A

CDIP - 5.08 mm max height

CERAMIC DUAL IN LINE PACKAGE



LAND PATTERN EXAMPLE  
NON-SOLDER MASK DEFINED  
SCALE: 5X



4214771/A 05/2017

D (R-PDSO-G14)

PLASTIC SMALL OUTLINE



- NOTES:
- A. All linear dimensions are in inches (millimeters).
  - B. This drawing is subject to change without notice.
  -  Body length does not include mold flash, protrusions, or gate burrs. Mold flash, protrusions, or gate burrs shall not exceed 0.006 (0,15) each side.
  -  Body width does not include interlead flash. Interlead flash shall not exceed 0.017 (0,43) each side.
  - E. Reference JEDEC MS-012 variation AB.

D (R-PDSO-G14)

PLASTIC SMALL OUTLINE



- NOTES:
- All linear dimensions are in millimeters.
  - This drawing is subject to change without notice.
  - Publication IPC-7351 is recommended for alternate designs.
  - Laser cutting apertures with trapezoidal walls and also rounding corners will offer better paste release. Customers should contact their board assembly site for stencil design recommendations. Refer to IPC-7525 for other stencil recommendations.
  - Customers should contact their board fabrication site for solder mask tolerances between and around signal pads.

PW (R-PDSO-G14)

PLASTIC SMALL OUTLINE



4040064-3/G 02/11

- NOTES:
- A. All linear dimensions are in millimeters. Dimensioning and tolerancing per ASME Y14.5M-1994.
  - B. This drawing is subject to change without notice.
  - C. Body length does not include mold flash, protrusions, or gate burrs. Mold flash, protrusions, or gate burrs shall not exceed 0,15 each side.
  - D. Body width does not include interlead flash. Interlead flash shall not exceed 0,25 each side.
  - E. Falls within JEDEC MO-153



PW (R-PDSO-G14)

PLASTIC SMALL OUTLINE



4211284-2/G 08/15

- NOTES:
- All linear dimensions are in millimeters.
  - This drawing is subject to change without notice.
  - Publication IPC-7351 is recommended for alternate designs.
  - Laser cutting apertures with trapezoidal walls and also rounding corners will offer better paste release. Customers should contact their board assembly site for stencil design recommendations. Refer to IPC-7525 for other stencil recommendations.
  - Customers should contact their board fabrication site for solder mask tolerances between and around signal pads.



D0008A

# PACKAGE OUTLINE

SOIC - 1.75 mm max height

SMALL OUTLINE INTEGRATED CIRCUIT



4214825/C 02/2019

### NOTES:

- Linear dimensions are in inches [millimeters]. Dimensions in parenthesis are for reference only. Controlling dimensions are in inches. Dimensioning and tolerancing per ASME Y14.5M.
- This drawing is subject to change without notice.
- This dimension does not include mold flash, protrusions, or gate burrs. Mold flash, protrusions, or gate burrs shall not exceed  $.006$  [0.15] per side.
- This dimension does not include interlead flash.
- Reference JEDEC registration MS-012, variation AA.

# EXAMPLE BOARD LAYOUT

D0008A

SOIC - 1.75 mm max height

SMALL OUTLINE INTEGRATED CIRCUIT



LAND PATTERN EXAMPLE  
 EXPOSED METAL SHOWN  
 SCALE:8X



SOLDER MASK DETAILS

4214825/C 02/2019

NOTES: (continued)

- 6. Publication IPC-7351 may have alternate designs.
- 7. Solder mask tolerances between and around signal pads can vary based on board fabrication site.

# EXAMPLE STENCIL DESIGN

D0008A

SOIC - 1.75 mm max height

SMALL OUTLINE INTEGRATED CIRCUIT



SOLDER PASTE EXAMPLE  
BASED ON .005 INCH [0.125 MM] THICK STENCIL  
SCALE:8X

4214825/C 02/2019

NOTES: (continued)

8. Laser cutting apertures with trapezoidal walls and rounded corners may offer better paste release. IPC-7525 may have alternate design recommendations.
9. Board assembly site may have different recommendations for stencil design.

## MECHANICAL DATA

PS (R-PDSO-G8)

PLASTIC SMALL-OUTLINE PACKAGE



- NOTES:
- A. All linear dimensions are in millimeters.
  - B. This drawing is subject to change without notice.
  - C. Body dimensions do not include mold flash or protrusion, not to exceed 0,15.

PS (R-PDSO-G8)

PLASTIC SMALL OUTLINE



- NOTES:
- A. All linear dimensions are in millimeters.
  - B. This drawing is subject to change without notice.
  - C. Publication IPC-7351 is recommended for alternate designs.
  - D. Laser cutting apertures with trapezoidal walls and also rounding corners will offer better paste release. Customers should contact their board assembly site for stencil design recommendations. Refer to IPC-7525 for other stencil recommendations.
  - E. Customers should contact their board fabrication site for solder mask tolerances between and around signal pads.

JG (R-GDIP-T8)

CERAMIC DUAL-IN-LINE



- NOTES: A. All linear dimensions are in inches (millimeters).  
 B. This drawing is subject to change without notice.  
 C. This package can be hermetically sealed with a ceramic lid using glass frit.  
 D. Index point is provided on cap for terminal identification.  
 E. Falls within MIL STD 1835 GDIP1-T8

P (R-PDIP-T8)

PLASTIC DUAL-IN-LINE PACKAGE



- NOTES:
- A. All linear dimensions are in inches (millimeters).
  - B. This drawing is subject to change without notice.
  - C. Falls within JEDEC MS-001 variation BA.



N (R-PDIP-T\*\*)

PLASTIC DUAL-IN-LINE PACKAGE

16 PINS SHOWN



- NOTES:
- A. All linear dimensions are in inches (millimeters).
  - B. This drawing is subject to change without notice.
  - C Falls within JEDEC MS-001, except 18 and 20 pin minimum body length (Dim A).
  - D The 20 pin end lead shoulder width is a vendor option, either half or full width.

4040049/E 12/2002

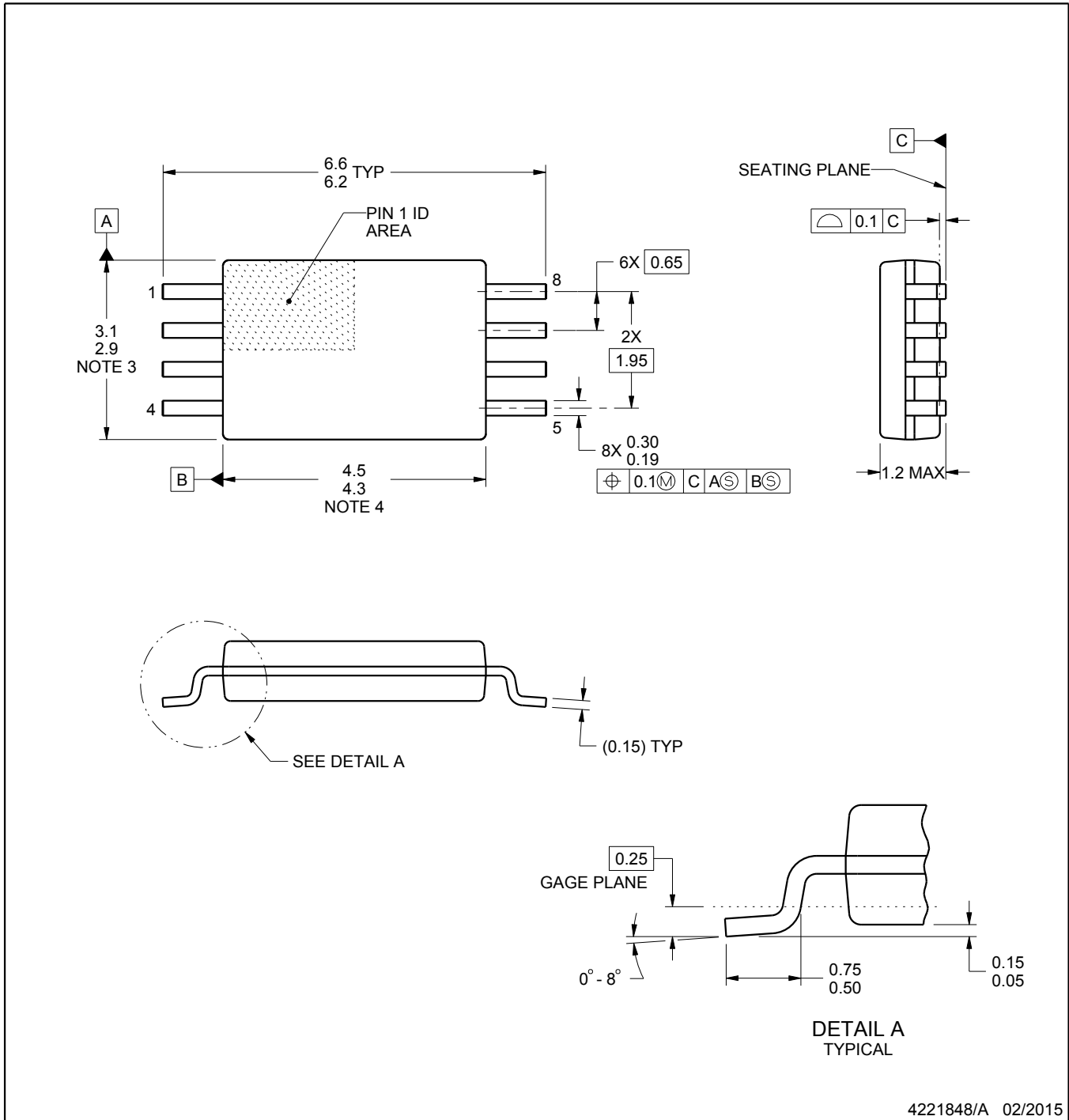
PW0008A



# PACKAGE OUTLINE

TSSOP - 1.2 mm max height

SMALL OUTLINE PACKAGE



4221848/A 02/2015

**NOTES:**

1. All linear dimensions are in millimeters. Any dimensions in parenthesis are for reference only. Dimensioning and tolerancing per ASME Y14.5M.
2. This drawing is subject to change without notice.
3. This dimension does not include mold flash, protrusions, or gate burrs. Mold flash, protrusions, or gate burrs shall not exceed 0.15 mm per side.
4. This dimension does not include interlead flash. Interlead flash shall not exceed 0.25 mm per side.
5. Reference JEDEC registration MO-153, variation AA.

# EXAMPLE BOARD LAYOUT

PW0008A

TSSOP - 1.2 mm max height

SMALL OUTLINE PACKAGE



LAND PATTERN EXAMPLE  
SCALE:10X



SOLDER MASK DETAILS  
NOT TO SCALE

4221848/A 02/2015

NOTES: (continued)

- 6. Publication IPC-7351 may have alternate designs.
- 7. Solder mask tolerances between and around signal pads can vary based on board fabrication site.

# EXAMPLE STENCIL DESIGN

PW0008A

TSSOP - 1.2 mm max height

SMALL OUTLINE PACKAGE



SOLDER PASTE EXAMPLE  
BASED ON 0.125 mm THICK STENCIL  
SCALE:10X

4221848/A 02/2015

NOTES: (continued)

8. Laser cutting apertures with trapezoidal walls and rounded corners may offer better paste release. IPC-7525 may have alternate design recommendations.
9. Board assembly site may have different recommendations for stencil design.

DB (R-PDSO-G\*\*)

PLASTIC SMALL-OUTLINE

28 PINS SHOWN



- NOTES: A. All linear dimensions are in millimeters.  
 B. This drawing is subject to change without notice.  
 C. Body dimensions do not include mold flash or protrusion not to exceed 0,15.  
 D. Falls within JEDEC MO-150

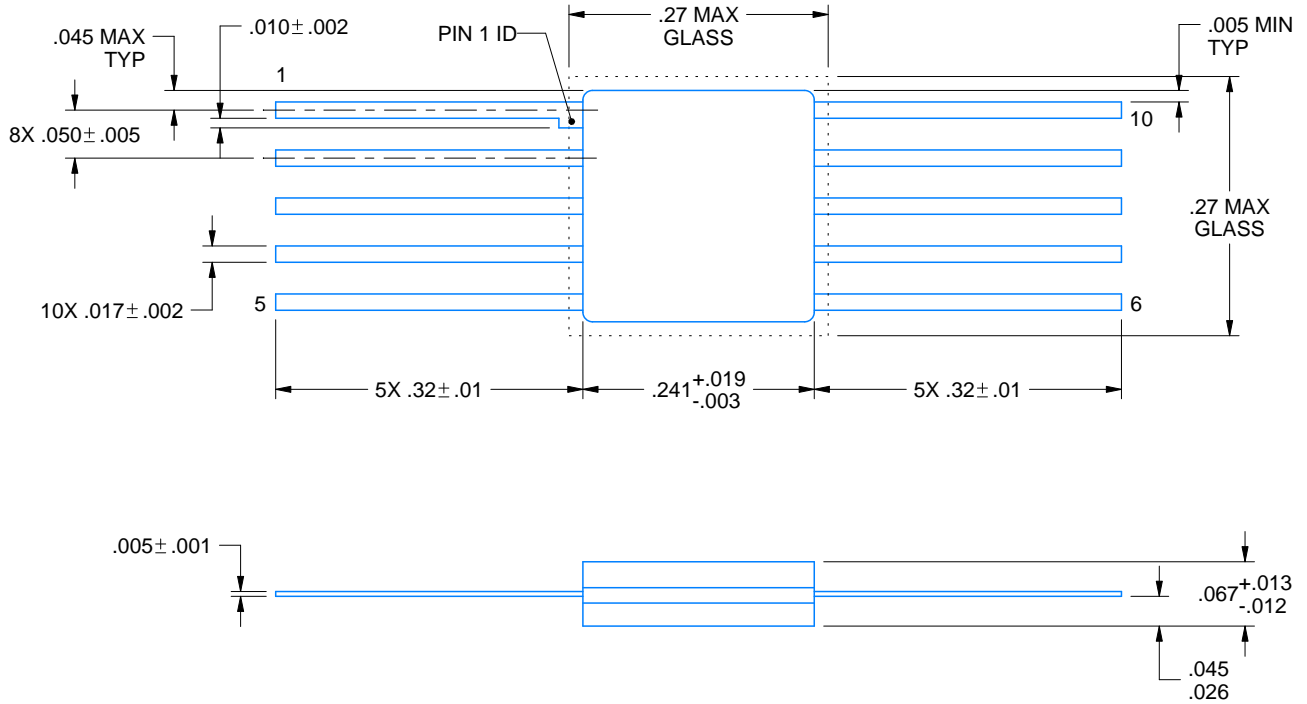
U0010A



# PACKAGE OUTLINE

CFP - 2.03 mm max height

CERAMIC FLATPACK



4225582/A 01/2020

NOTES:

1. All linear dimensions are in inches. Any dimensions in parenthesis are for reference only. Dimensioning and tolerancing per ASME Y14.5M.
2. This drawing is subject to change without notice.

## IMPORTANT NOTICE AND DISCLAIMER

TI PROVIDES TECHNICAL AND RELIABILITY DATA (INCLUDING DATASHEETS), DESIGN RESOURCES (INCLUDING REFERENCE DESIGNS), APPLICATION OR OTHER DESIGN ADVICE, WEB TOOLS, SAFETY INFORMATION, AND OTHER RESOURCES "AS IS" AND WITH ALL FAULTS, AND DISCLAIMS ALL WARRANTIES, EXPRESS AND IMPLIED, INCLUDING WITHOUT LIMITATION ANY IMPLIED WARRANTIES OF MERCHANTABILITY, FITNESS FOR A PARTICULAR PURPOSE OR NON-INFRINGEMENT OF THIRD PARTY INTELLECTUAL PROPERTY RIGHTS.

These resources are intended for skilled developers designing with TI products. You are solely responsible for (1) selecting the appropriate TI products for your application, (2) designing, validating and testing your application, and (3) ensuring your application meets applicable standards, and any other safety, security, or other requirements. These resources are subject to change without notice. TI grants you permission to use these resources only for development of an application that uses the TI products described in the resource. Other reproduction and display of these resources is prohibited. No license is granted to any other TI intellectual property right or to any third party intellectual property right. TI disclaims responsibility for, and you will fully indemnify TI and its representatives against, any claims, damages, costs, losses, and liabilities arising out of your use of these resources.

TI's products are provided subject to TI's Terms of Sale (<https://www.ti.com/legal/termsofsale.html>) or other applicable terms available either on [ti.com](https://www.ti.com) or provided in conjunction with such TI products. TI's provision of these resources does not expand or otherwise alter TI's applicable warranties or warranty disclaimers for TI products.

Mailing Address: Texas Instruments, Post Office Box 655303, Dallas, Texas 75265  
Copyright © 2021, Texas Instruments Incorporated