

OSC50324P-24.576MHZ

Features

- Low power supply voltage (1.8V)
- LVPECL output level.
- Supports a WIDE FREQUENCY RANGE (32.768KHZ to 160 MHz)
- Low phase jitter: Max, 1ps
- Compact with dimensions of 5.0*3.2*1.2mm.

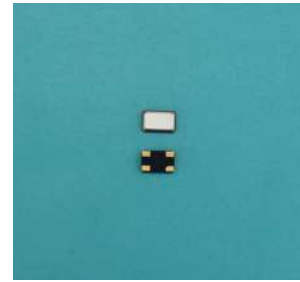

Specifications

项目 Item	技术 Specifications	
频率范围 Freq. Range	24.576MHZ	
频率稳定性 Frequency Stability	$\pm 10\text{PPm}$ $\pm 20\text{PPm}$ $\pm 30\text{PPm}$ $\pm 50\text{PPm}$	
工作温度 Operating Temp	-20°C to 70°C -40°C to 85°C	
储存温度 Storage Temp	-40°C to 85°C -55°C to 125°C	
输入电压 Input	+5Vdc $\pm 10\%$ or +3.3Vdc $\pm 10\%$ +1.8Vdc $\pm 10\%$	
占空比 Symmetry	40/60 Standard	
输出 Output Load	10 TTL or 15PF HCMOS	
消耗电流	Current Consumption 15pf only) (5.0V)	1.000MHZ - 36.000MHZ = 25mA max 36.000MHZ - 70.000MHZ = 60mA max 70.000MHZ - 150.000MHZ = 80mA max
	Current Consumption 15pf only) (1.8V, 2.5V, 2.85V, 3.3V)	1.000MHZ - 36.000MHZ = 20mA max 36.000MHZ - 70.000MHZ = 40mA max 70.000MHZ - 150.000MHZ = 60mA max
上升/下降时间 Rise/Fall Time	10nS max	

Dimensions

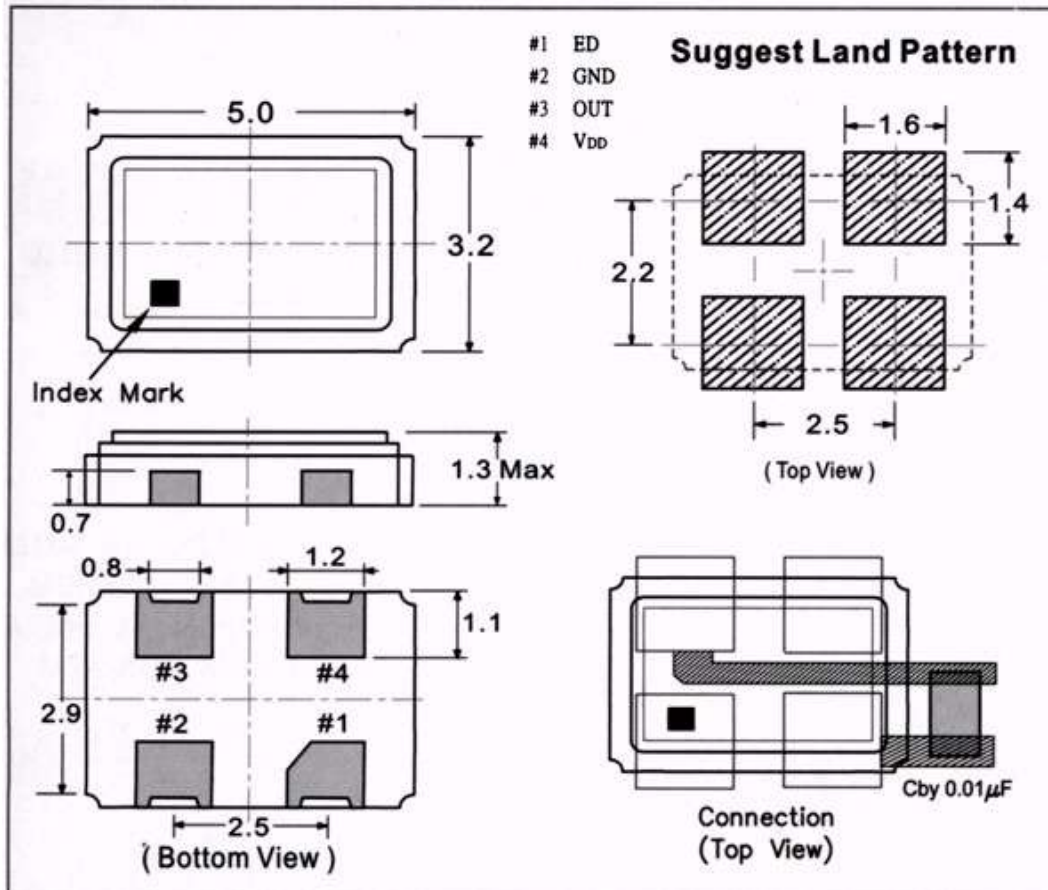

Ordering Information

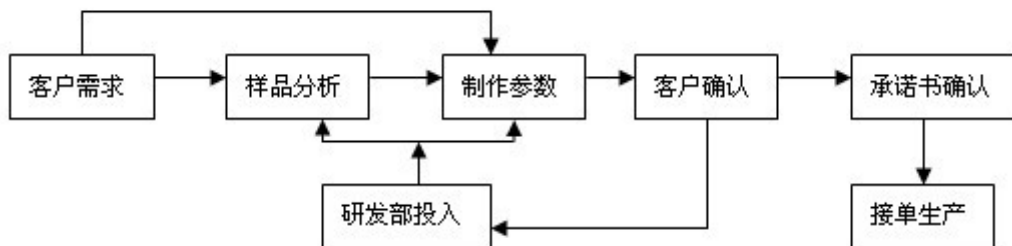

使用电路图和引出端功能说明

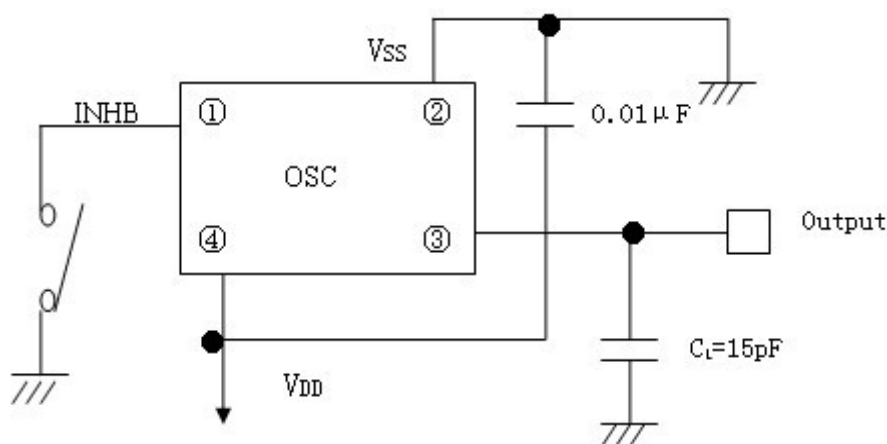

引脚	1	2	3	4
功能	输出状态控制/NC	地VSS	输出QOUT	电源VDD

输出控制端INHB	"H" 高电平或开路OPEN	"L" 低电平 (三态)
输出Qout	振荡器正常输出	高阻抗

注意：输出状态控制端INHB（三态端）不能接地，否则振荡器呈高阻抗

测试电路图

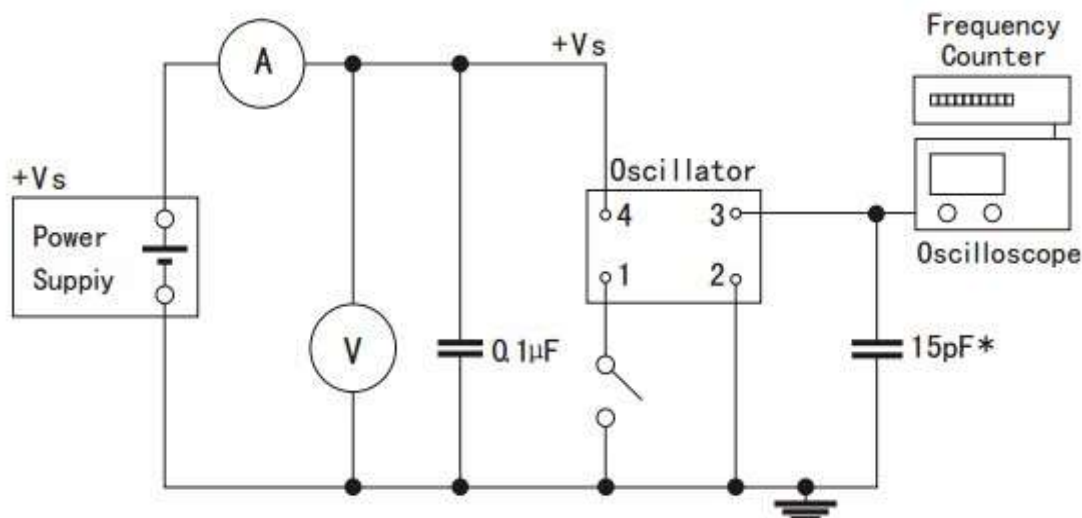

■ Reflow Condition

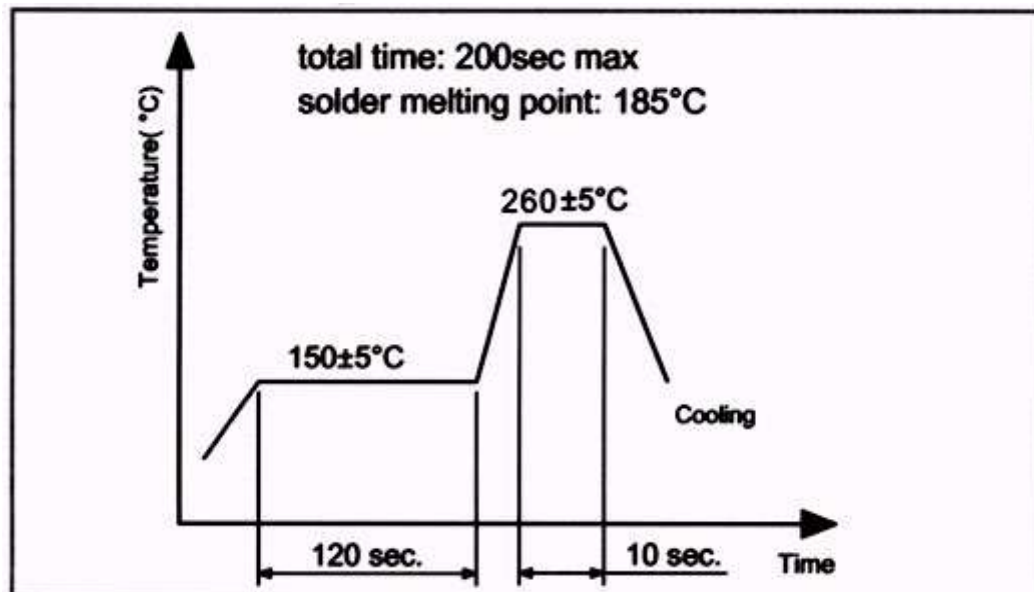

■ 输出波形图

