

# SKM 300GB123D

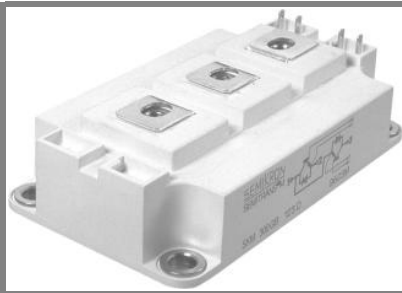

**SEMITRANS® 3**

## IGBT Modules

**SKM 300GB123D**

**SKM 300GAL123D**

**SKM 300GAR123D**

### Features

- MOS input (voltage controlled)
- N channel, Homogeneous Si
- Low inductance case
- Very low tail current with low temperature dependence
- High short circuit capability, self limiting to  $6 \times I_{Cnom}$
- Latch-up free
- Fast & soft inverse CAL diodes
- Isolated copper baseplate using DCB Direct Copper Bonding Technology
- Large clearance (12 mm) and creepage distance (20 mm)

### Typical Applications\*

- AC inverter drives
- UPS

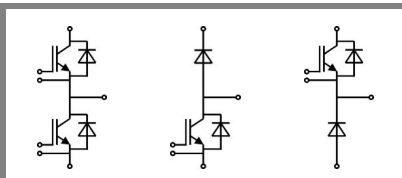

GB

GAL

GAR

Absolute Maximum Ratings		$T_c = 25^\circ\text{C}$ , unless otherwise specified		
Symbol	Conditions	Values	Units	
<b>IGBT</b>				
$V_{CES}$	$T_j = 25^\circ\text{C}$	1200	V	
$I_C$	$T_j = 150^\circ\text{C}$	$T_{case} = 25^\circ\text{C}$	300	A
		$T_{case} = 80^\circ\text{C}$	220	A
$I_{CRM}$	$I_{CRM} = 2 \times I_{Cnom}$	400	A	
$V_{GES}$		$\pm 20$	V	
$t_{psc}$	$V_{CC} = 600\text{ V}; V_{GE} \leq 20\text{ V}; T_j = 125^\circ\text{C}$ $V_{CES} < 1200\text{ V}$	10	$\mu\text{s}$	

Inverse Diode		$T_c = 25^\circ\text{C}$ , unless otherwise specified		
Symbol	Conditions	Values	Units	
$I_F$	$T_j = 150^\circ\text{C}$	$T_{case} = 25^\circ\text{C}$	260	A
		$T_{case} = 80^\circ\text{C}$	180	A
$I_{FRM}$	$I_{FRM} = 2 \times I_{Fnom}$	400	A	
$I_{FSM}$	$t_p = 10\text{ ms}; \sin.$	$T_j = 150^\circ\text{C}$	2200	A

Freewheeling Diode		$T_c = 25^\circ\text{C}$ , unless otherwise specified		
Symbol	Conditions	Values	Units	
$I_F$	$T_j = 150^\circ\text{C}$	$T_{case} = 25^\circ\text{C}$	350	A
		$T_{case} = 80^\circ\text{C}$	230	A
$I_{FRM}$	$I_{FRM} = 2 \times I_{Fnom}$	600	A	
$I_{FSM}$	$t_p = 10\text{ ms}; \sin$	$T_j = 150^\circ\text{C}$	2900	A

Module		$T_c = 25^\circ\text{C}$ , unless otherwise specified	
Symbol	Conditions	Values	Units
$I_{t(RMS)}$		500	A
$T_{vj}$		- 40...+ 150	$^\circ\text{C}$
$T_{stg}$		- 40...+ 125	$^\circ\text{C}$
$V_{isol}$	AC, 1 min.	2500	V

Characteristics		$T_c = 25^\circ\text{C}$ , unless otherwise specified			
Symbol	Conditions	min.	typ.	max.	Units
<b>IGBT</b>					
$V_{GE(th)}$	$V_{GE} = V_{CE}, I_C = 8\text{ mA}$	4,5	5,5	6,5	V
$I_{CES}$	$V_{GE} = 0\text{ V}, V_{CE} = V_{CES}$		0,1	0,3	mA
$V_{CE0}$		$T_j = 25^\circ\text{C}$	1,4	1,6	V
		$T_j = 125^\circ\text{C}$	1,6	1,8	V
$r_{CE}$	$V_{GE} = 15\text{ V}$	$T_j = 25^\circ\text{C}$	5,5	7	m $\Omega$
		$T_j = 125^\circ\text{C}$	7,5	9,5	m $\Omega$
$V_{CE(sat)}$	$I_{Cnom} = 200\text{ A}, V_{GE} = 15\text{ V}$	$T_j = 25^\circ\text{C}_{chiplev.}$	2,5	3	V
		$T_j = 125^\circ\text{C}_{chiplev.}$	3,1	3,7	V
$C_{res}$	$V_{CE} = 25\text{ V}, V_{GE} = 0\text{ V}$	$f = 1\text{ MHz}$	18	24	nF
$C_{oes}$			2,5	3,2	nF
$C_{res}$			1	1,3	nF
$Q_G$	-8V - +20V		2000		nC
$R_{Gint}$	$T_j = ^\circ\text{C}$		2,5		$\Omega$
$t_{d(on)}$	$R_{Gon} = 4,7\ \Omega$	$V_{CC} = 600\text{ V}$ $I_C = 200\text{ A}$	250	400	ns
$t_r$			90	160	ns
$E_{on}$	$R_{Goff} = 4,7\ \Omega$	$T_j = 125^\circ\text{C}$	28		mJ
$t_{d(off)}$			550	700	ns
$t_f$			70	100	ns
$E_{off}$			26		mJ
$R_{th(j-c)}$	per IGBT			0,075	K/W

# SKM 300GB123D

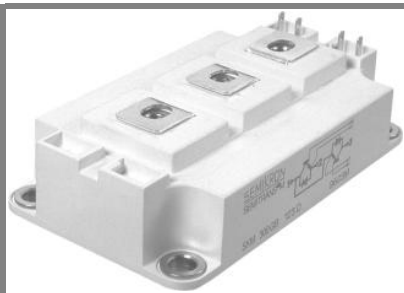

SEMITRANS® 3

## IGBT Modules

SKM 300GB123D

SKM 300GAL123D

SKM 300GAR123D

### Features

- MOS input (voltage controlled)
- N channel, Homogeneous Si
- Low inductance case
- Very low tail current with low temperature dependence
- High short circuit capability, self limiting to  $6 \times I_{cnom}$
- Latch-up free
- Fast & soft inverse CAL diodes
- Isolated copper baseplate using DCB Direct Copper Bonding Technology
- Large clearance (12 mm) and creepage distance (20 mm)

### Typical Applications\*

- AC inverter drives
- UPS

Characteristics					
Symbol	Conditions	min.	typ.	max.	Units
<b>Inverse Diode</b>					
$V_F = V_{EC}$	$I_{Fnom} = 200 \text{ A}; V_{GE} = 0 \text{ V}$	$T_j = 25 \text{ }^\circ\text{C}_{chiplev.}$	2	2,5	V
$V_{F0}$		$T_j = 25 \text{ }^\circ\text{C}$	1,1	1,2	V
		$T_j = 125 \text{ }^\circ\text{C}$			V
$r_F$		$T_j = 25 \text{ }^\circ\text{C}$	4,5	6,5	mΩ
		$T_j = 125 \text{ }^\circ\text{C}$			mΩ
$I_{RRM}$	$I_F = 200 \text{ A}$	$T_j = 125 \text{ }^\circ\text{C}$	105		A
$Q_{rr}$	$di/dt = 4000 \text{ A}/\mu\text{s}$		10		μC
$E_{rr}$	$V_{GE} = 0 \text{ V}; V_{CC} = 600 \text{ V}$				mJ
$R_{th(j-c)D}$	per diode			0,18	K/W
<b>Freewheeling Diode</b>					
$V_F = V_{EC}$	$I_{Fnom} = 300 \text{ A}; V_{GE} = 0 \text{ V}$	$T_j = 25 \text{ }^\circ\text{C}_{chiplev.}$	2	2,5	V
$V_{F0}$		$T_j = 25 \text{ }^\circ\text{C}$	1,1	1,2	V
		$T_j = 125 \text{ }^\circ\text{C}$			V
$r_F$		$T_j = 25 \text{ }^\circ\text{C}$	3	4,3	V
		$T_j = 125 \text{ }^\circ\text{C}$			V
$I_{RRM}$	$I_F = 200 \text{ A}$	$T_j = 125 \text{ }^\circ\text{C}$	140		A
$Q_{rr}$	$di/dt = 3500 \text{ A}/\mu\text{s}$		34		μC
$E_{rr}$	$V_{GE} = 0 \text{ V}; V_{CC} = 600 \text{ V}$				mJ
$R_{th(j-c)FD}$	per diode			0,15	K/W
<b>Module</b>					
$L_{CE}$			15	20	nH
$R_{CC+EE'}$	res., terminal-chip	$T_{case} = 25 \text{ }^\circ\text{C}$	0,35		mΩ
		$T_{case} = 125 \text{ }^\circ\text{C}$	0,5		mΩ
$R_{th(c-s)}$	per module			0,038	K/W
$M_s$	to heat sink M6		3	5	Nm
$M_t$	to terminals M6		2,5	5	Nm
w				325	g

This is an electrostatic discharge sensitive device (ESDS), international standard IEC 60747-1, Chapter IX.

\* The specifications of our components may not be considered as an assurance of component characteristics. Components have to be tested for the respective application. Adjustments may be necessary. The use of SEMIKRON products in life support appliances and systems is subject to prior specification and written approval by SEMIKRON. We therefore strongly recommend prior consultation of our personal.

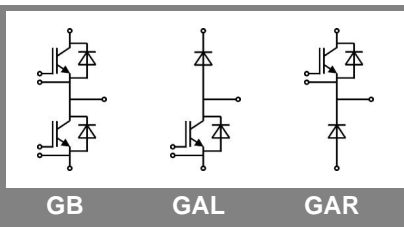

# SKM 300GB123D

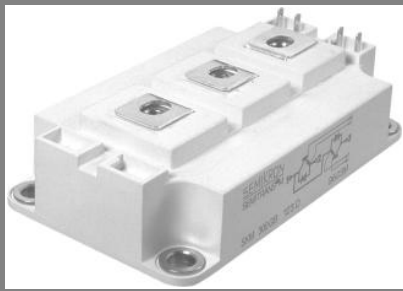

**SEMITRANS<sup>®</sup> 3**

## IGBT Modules

**SKM 300GB123D**

**SKM 300GAL123D**

**SKM 300GAR123D**

### Features

- MOS input (voltage controlled)
- N channel , Homogeneous Si
- Low inductance case
- Very low tail current with low temperature dependence
- High short circuit capability, self limiting to  $6 \times I_{cnom}$
- Latch-up free
- Fast & soft inverse CAL diodes
- Isolated copper baseplate using DCB Direct Copper Bonding Technology
- Large clearance (12 mm) and creepage distance (20 mm)

### Typical Applications\*

- AC inverter drives
- UPS

$Z_{th}$		Values	Units
Symbol	Conditions		
$Z_{th(j-c)I}$			
$R_i$	$i = 1$	53	mk/W
$R_i$	$i = 2$	18,5	mk/W
$R_i$	$i = 3$	3,1	mk/W
$R_i$	$i = 4$	0,4	mk/W
$\tau_{ai}$	$i = 1$	0,04	s
$\tau_{ai}$	$i = 2$	0,0189	s
$\tau_{ai}$	$i = 3$	0,0017	s
$\tau_{ai}$	$i = 4$	0,003	s
$Z_{th(j-c)D}$			
$R_i$	$i = 1$	0,1151	mk/W
$R_i$	$i = 2$	0,0525	mk/W
$R_i$	$i = 3$	0,0111	mk/W
$R_i$	$i = 4$	0,0022	mk/W
$\tau_{ai}$	$i = 1$	0,0366	s
$\tau_{ai}$	$i = 2$	0,0113	s
$\tau_{ai}$	$i = 3$	0,003	s
$\tau_{ai}$	$i = 4$	0,0002	s

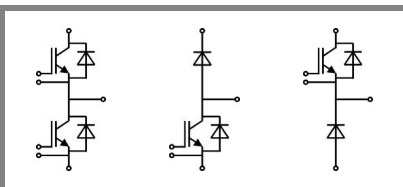

GB

GAL

GAR

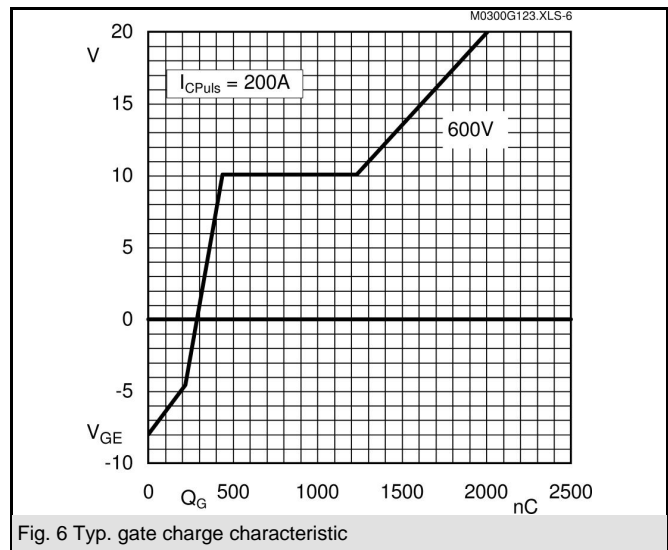
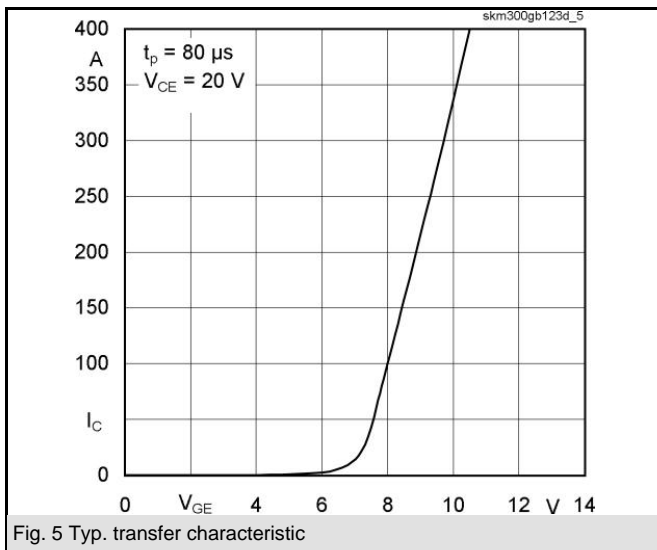
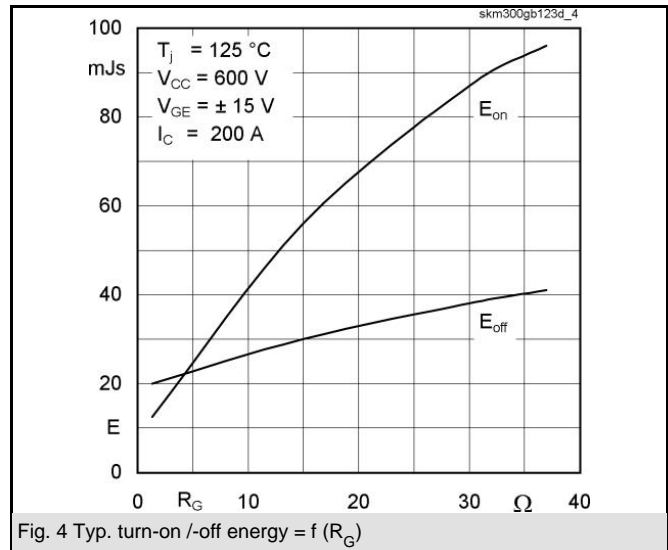
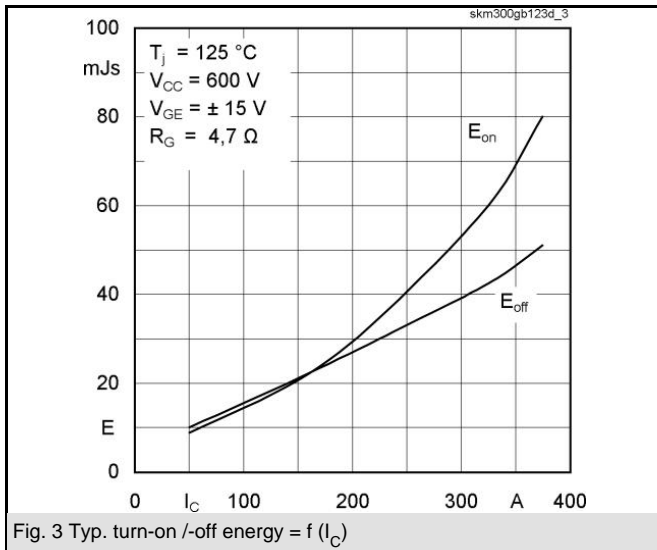
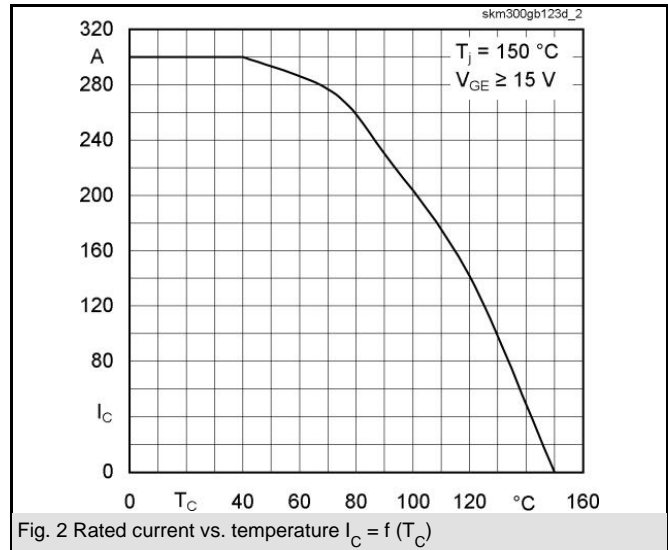
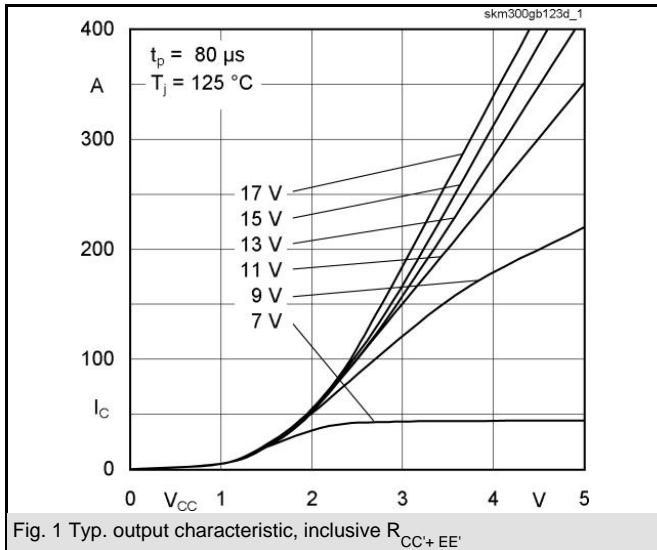

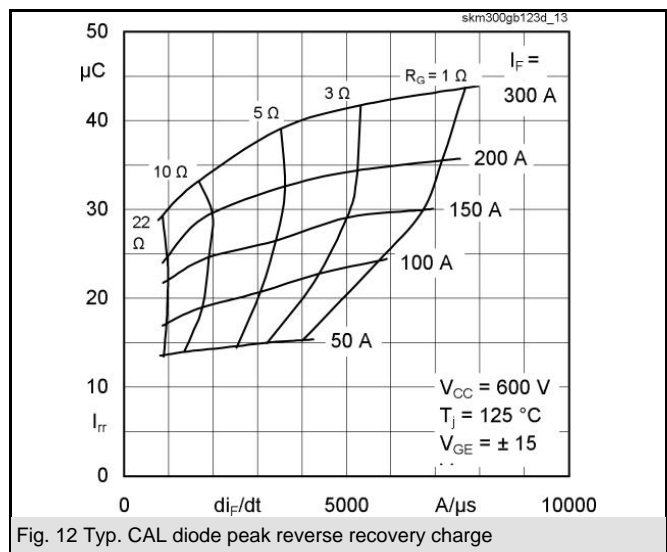
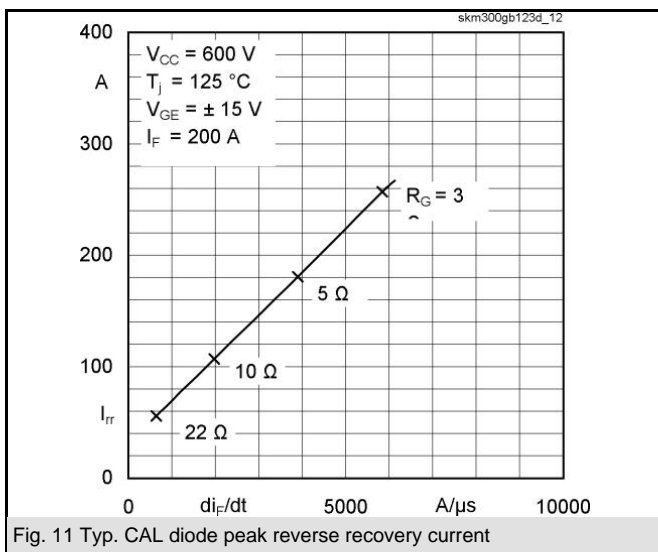
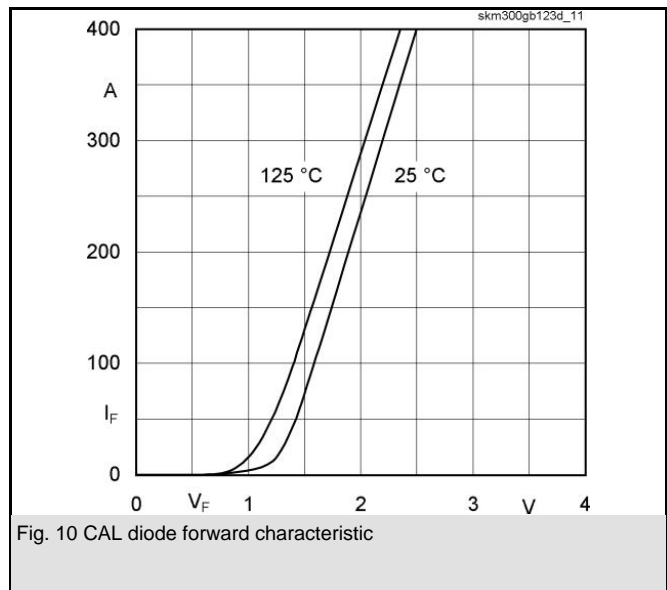
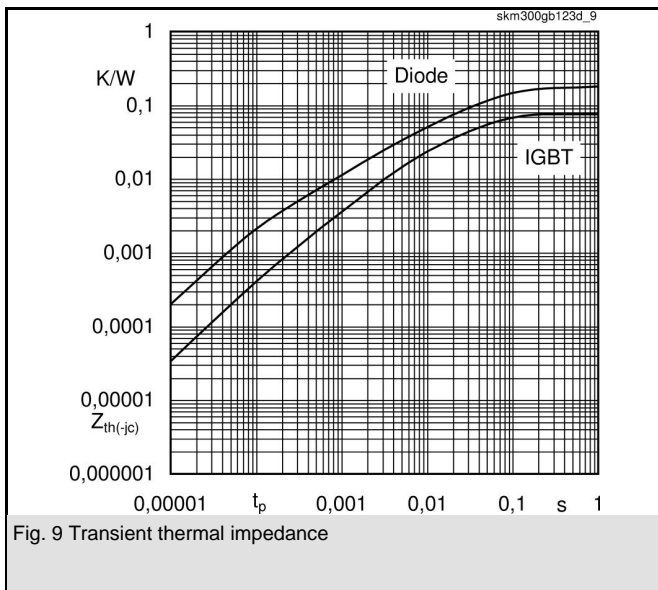
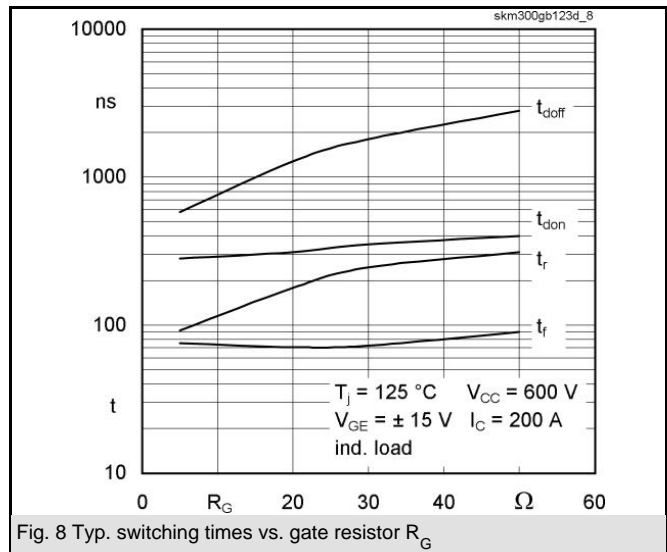
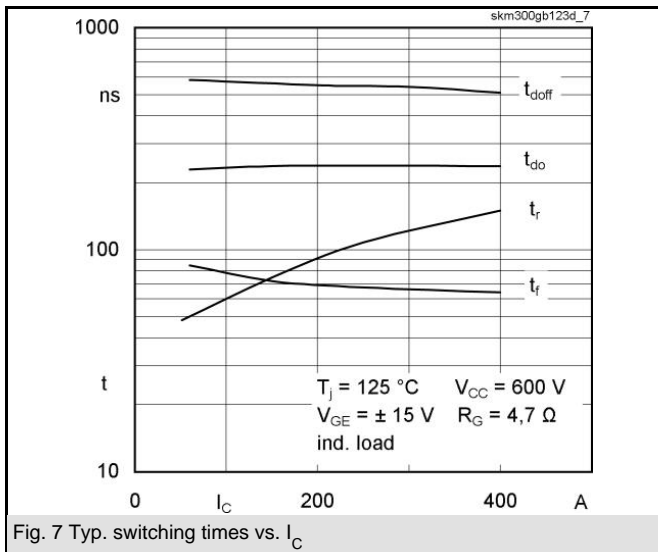

# SKM 300GB123D

UL Recognized

CASED56

File 63 532

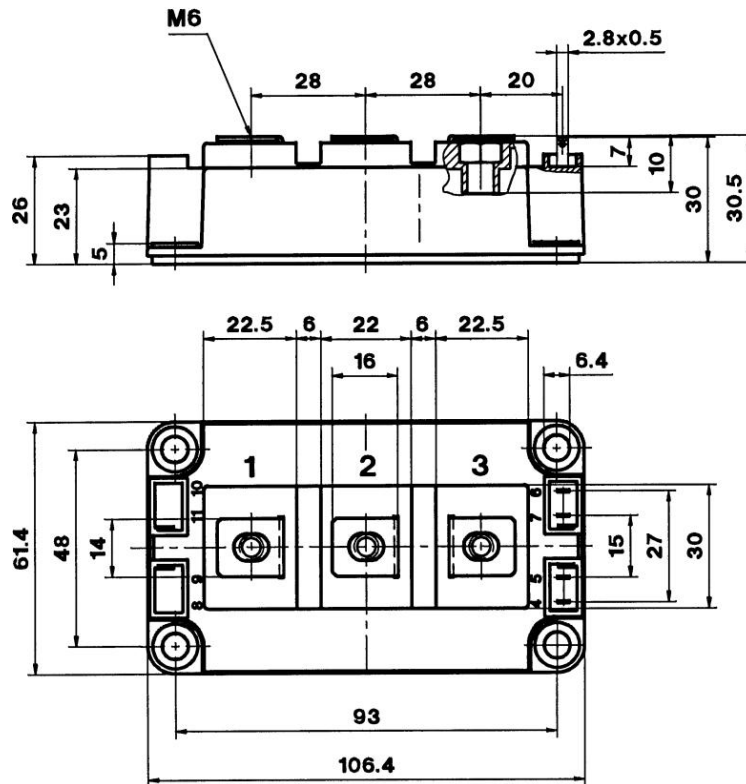

Case D 56

