

Thyristor Modules

Thyristor/Diode Modules

$$I_{TRMS} = 2 \times 300 \text{ A}$$

$$I_{TAVM} = 2 \times 130 \text{ A}$$

$$V_{RRM} = 800\text{-}1800 \text{ V}$$

V_{RSM} V_{DSM}	V_{RRM} V_{DRM}	Type	
V	V	Version 1	Version 1
900	800	MCC 132-08io1	MCD 132-08io1
1300	1200	MCC 132-12io1	MCD 132-12io1
1500	1400	MCC 132-14io1	MCD 132-14io1
1700	1600	MCC 132-16io1	MCD 132-16io1
1900	1800	MCC 132-18io1	MCD 132-18io1

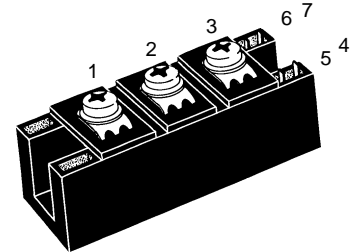

Symbol	Test Conditions	Maximum Ratings	
I_{TRMS}, I_{FRMS} I_{TAVM}, I_{FAVM}	$T_{VJ} = T_{VJM}$ $T_C = 85^\circ\text{C}; 180^\circ \text{ sine}$	300 130	A A
I_{TSM}, I_{FSM}	$T_{VJ} = 45^\circ\text{C};$ $V_R = 0$	$t = 10 \text{ ms (50 Hz), sine}$ $t = 8.3 \text{ ms (60 Hz), sine}$	4750 5080 A A
	$T_{VJ} = T_{VJM}$ $V_R = 0$	$t = 10 \text{ ms (50 Hz), sine}$ $t = 8.3 \text{ ms (60 Hz), sine}$	4230 4530 A A
$\int i^2 dt$	$T_{VJ} = 45^\circ\text{C}$ $V_R = 0$	$t = 10 \text{ ms (50 Hz), sine}$ $t = 8.3 \text{ ms (60 Hz), sine}$	113 000 108 000 A^2s A^2s
	$T_{VJ} = T_{VJM}$ $V_R = 0$	$t = 10 \text{ ms (50 Hz), sine}$ $t = 8.3 \text{ ms (60 Hz), sine}$	89 500 86 200 A^2s A^2s
$(di/dt)_{cr}$	$T_{VJ} = T_{VJM}$ $f = 50 \text{ Hz}, t_p = 200 \mu\text{s}$ $V_D = 2/3 V_{DRM}$ $I_G = 0.5 \text{ A}$ $di_G/dt = 0.5 \text{ A}/\mu\text{s}$	repetitive, $I_T = 500 \text{ A}$ non repetitive, $I_T = 500 \text{ A}$	150 500 $\text{A}/\mu\text{s}$ $\text{A}/\mu\text{s}$
$(dv/dt)_{cr}$	$T_{VJ} = T_{VJM};$ $R_{GK} = \infty; \text{ method 1 (linear voltage rise)}$	$V_{DR} = 2/3 V_{DRM}$	1000 $\text{V}/\mu\text{s}$
P_{GM}	$T_{VJ} = T_{VJM}$ $I_T = I_{TAVM}$	$t_p = 30 \mu\text{s}$ $t_p = 500 \mu\text{s}$	120 60 8 W W
P_{GAV}			8 W
V_{RGM}			10 V
T_{VJ}			-40...+125 $^\circ\text{C}$
T_{VJM}			125 $^\circ\text{C}$
T_{stg}			-40...+125 $^\circ\text{C}$
V_{ISOL}	50/60 Hz, RMS $I_{ISOL} \leq 1 \text{ mA}$	$t = 1 \text{ min}$ $t = 1 \text{ s}$	3000 3600 V~ V~
M_d	Mounting torque (M6) Terminal connection torque (M6)		2.25-2.75/20-25 4.5-5.5/40-48 $\text{Nm}/\text{lb.in.}$ $\text{Nm}/\text{lb.in.}$
Weight	Typical including screws		125 g

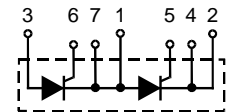
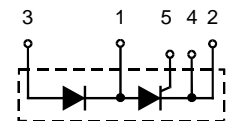
MCC

MCD

Features

- International standard package
- Direct copper bonded Al_2O_3 -ceramic base plate
- Planar passivated chips
- Isolation voltage 3600 V~
- UL registered, E 72873
- Keyed gate/cathode twin pins

Applications

- Motor control
- Power converter
- Heat and temperature control for industrial furnaces and chemical processes
- Lighting control
- Contactless switches

Advantages

- Space and weight savings
- Simple mounting
- Improved temperature and power cycling
- Reduced protection circuits

Data according to IEC 60747 and refer to a single thyristor/diode unless otherwise stated.
IXYS reserves the right to change limits, test conditions and dimensions

Symbol	Test Conditions	Characteristic Values
I_{RRM}, I_{DRM}	$T_{VJ} = T_{VJM}; V_R = V_{RRM}; V_D = V_{DRM}$	10 mA
V_T, V_F	$I_T, I_F = 300 \text{ A}; T_{VJ} = 25^\circ\text{C}$	1.36 V
V_{TO}	For power-loss calculations only ($T_{VJ} = 125^\circ\text{C}$)	0.8 V
r_T		1.5 mΩ
V_{GT}	$V_D = 6 \text{ V}; T_{VJ} = 25^\circ\text{C}$	2.5 V
	$T_{VJ} = -40^\circ\text{C}$	2.6 V
I_{GT}	$V_D = 6 \text{ V}; T_{VJ} = 25^\circ\text{C}$	150 mA
	$T_{VJ} = -40^\circ\text{C}$	200 mA
V_{GD}	$T_{VJ} = T_{VJM}; V_D = 2/3 V_{DRM}$	0.2 V
I_{GD}		10 mA
I_L	$T_{VJ} = 25^\circ\text{C}; t_p = 30 \mu\text{s}; V_D = 6 \text{ V}$ $I_G = 0.5 \text{ A}; di_G/dt = 0.5 \text{ A}/\mu\text{s}$	300 mA
I_H	$T_{VJ} = 25^\circ\text{C}; V_D = 6 \text{ V}; R_{GK} = \infty$	200 mA
t_{gd}	$T_{VJ} = 25^\circ\text{C}; V_D = 1/2 V_{DRM}$ $I_G = 0.5 \text{ A}; di_G/dt = 0.5 \text{ A}/\mu\text{s}$	2 μs
t_q	$T_{VJ} = T_{VJM}; I_T = 160 \text{ A}, t_p = 200 \mu\text{s}; -di/dt = 10 \text{ A}/\mu\text{s}$ typ. $V_R = 100 \text{ V}; dv/dt = 20 \text{ V}/\mu\text{s}; V_D = 2/3 V_{DRM}$	150 μs
Q_S	$T_{VJ} = T_{VJM}; I_T, I_F = 300 \text{ A}, -di/dt = 50 \text{ A}/\mu\text{s}$	550 μC
I_{RM}		235 A
R_{thJC}	per thyristor/diode; DC current per module	0.23 K/W
R_{thJK}	per thyristor/diode; DC current per module	0.115 K/W
	other values see Fig. 8/9	0.33 K/W
		0.165 K/W
d_s	Creepage distance on surface	12.7 mm
d_A	Strike distance through air	9.6 mm
a	Maximum allowable acceleration	50 m/s ²

Optional accessories for modules

Keyed gate/cathode twin plugs with wire length = 350 mm, gate = yellow, cathode = red

Type **ZY 180L** (L = Left for pin pair 4/5) } UL 758, style 1385,
Type **ZY 180R** (R = right for pin pair 6/7) } CSA class 5851, guide 460-1-1

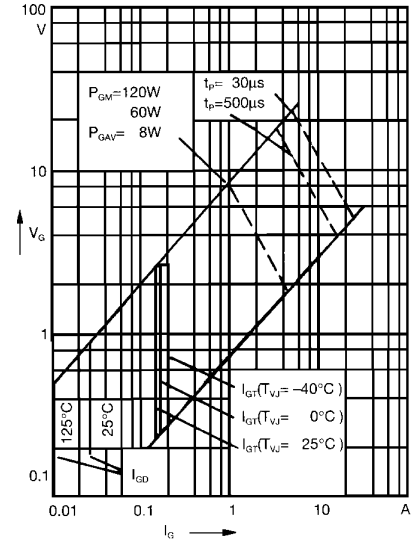

Fig. 1 Gate trigger characteristics

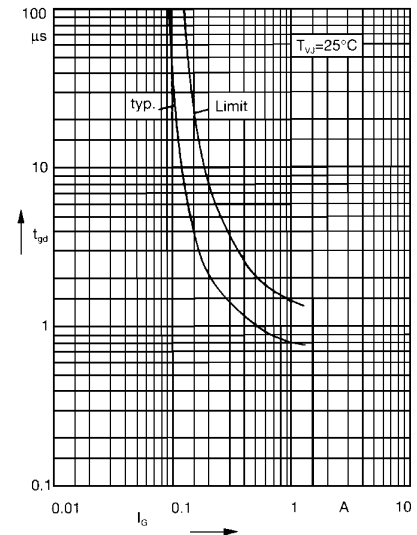
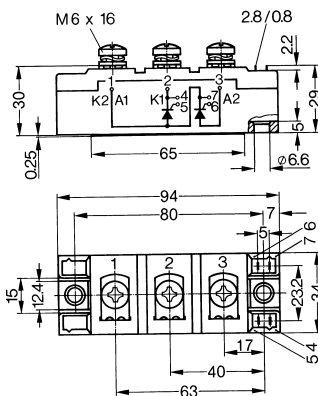

Fig. 2 Gate trigger delay time

Dimensions in mm (1 mm = 0.0394")

MCC



MCD

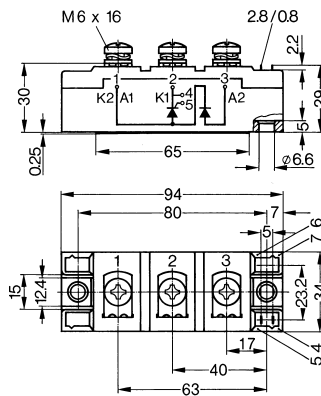

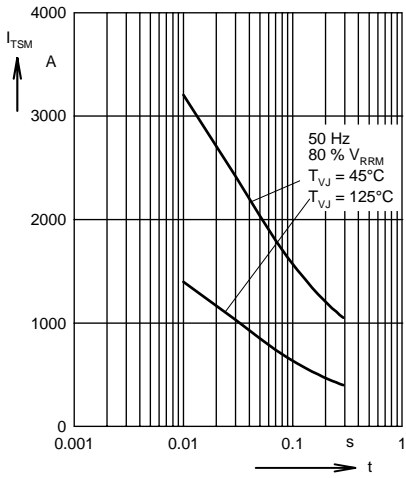

Fig. 3 Surge overload current
 I_{TSM} , I_{FSM} : Crest value, t : duration

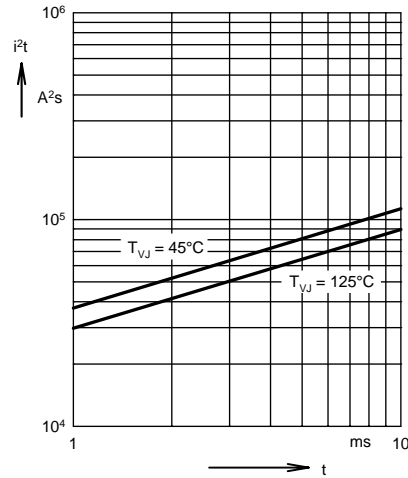

Fig. 4 i^2t versus time (1-10 ms)

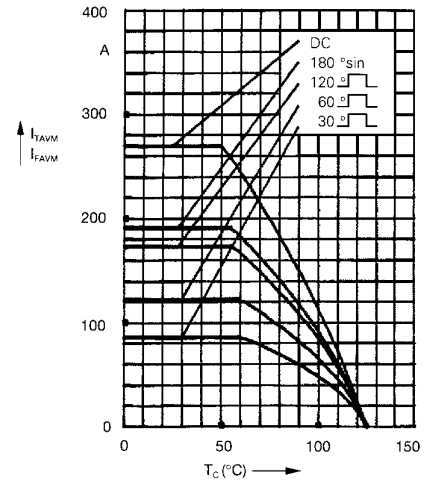

Fig. 4a Maximum forward current at case temperature

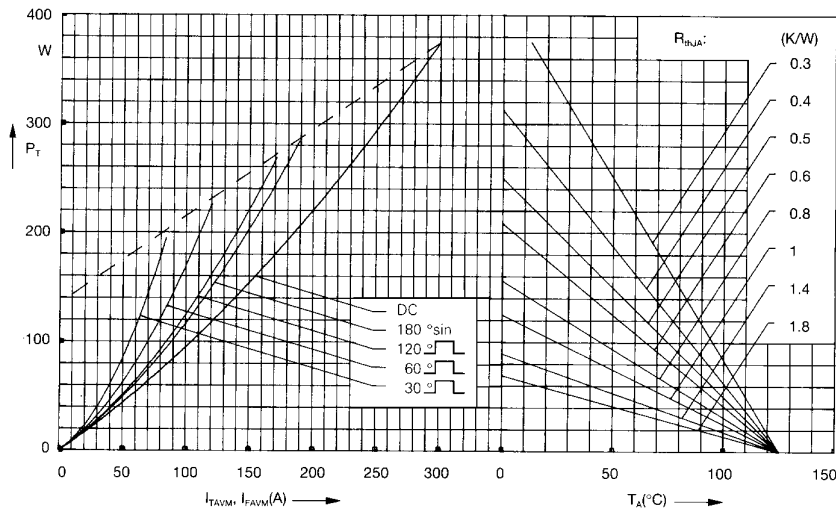

Fig. 5 Power dissipation versus on-state current and ambient temperature (per thyristor or diode)

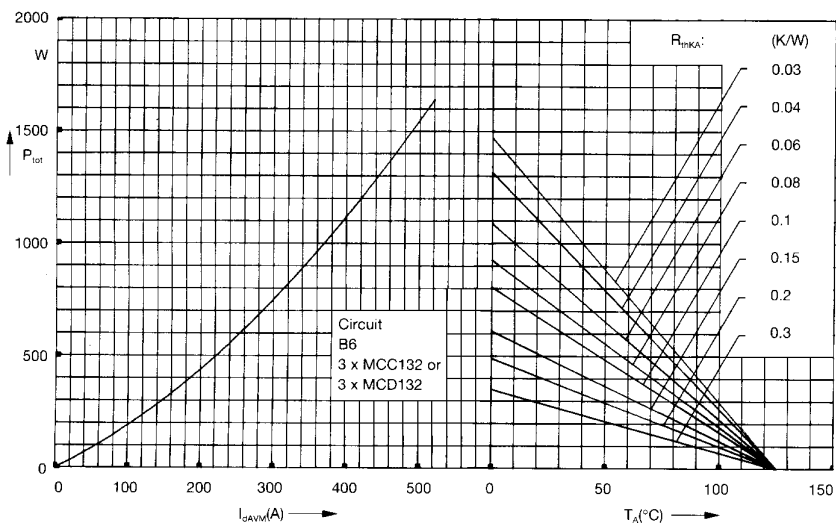

Fig. 6 Three phase rectifier bridge: Power dissipation versus direct output current and ambient temperature

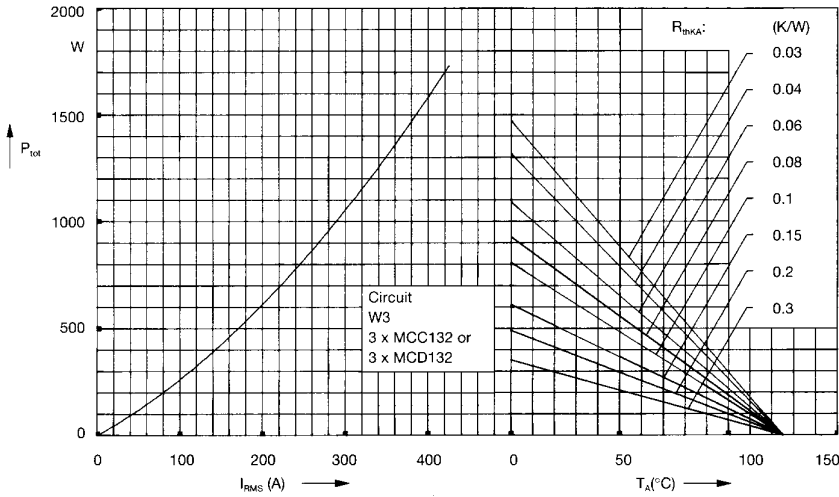

Fig. 7 Three phase AC-controller:
Power dissipation versus RMS
output current and ambient
temperature

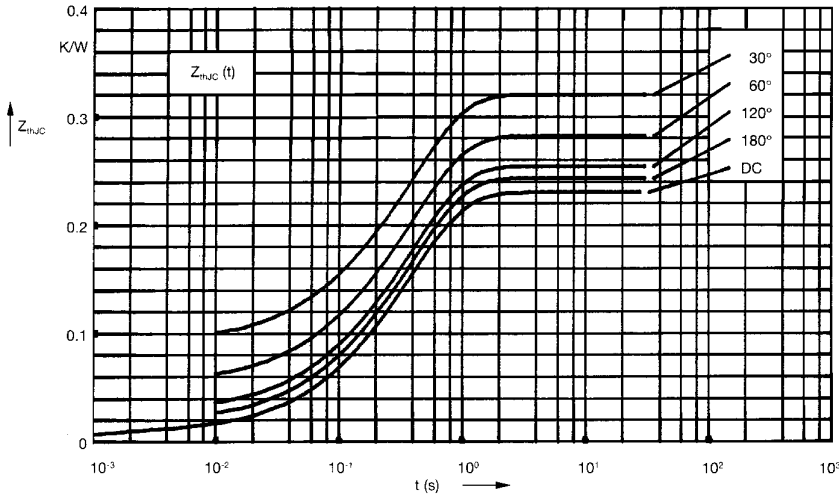

Fig. 8 Transient thermal impedance
junction to case (per thyristor or
diode)

R_{thJC} for various conduction angles d :

d	R_{thJC} (K/W)
DC	0.230
180°	0.244
120°	0.255
60°	0.283
30°	0.321

Constants for Z_{thJC} calculation:

i	R_{thi} (K/W)	t_i (s)
1	0.0095	0.001
2	0.0175	0.065
3	0.203	0.4

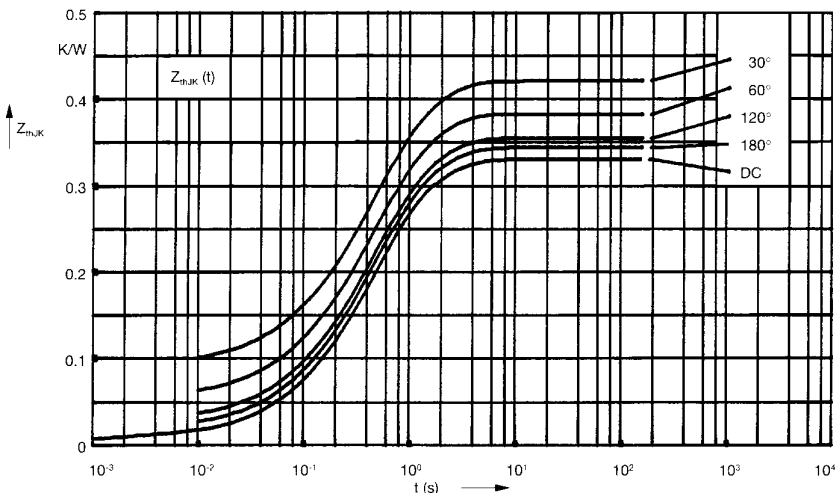

Fig. 9 Transient thermal impedance
junction to heatsink (per thyristor
or diode)

R_{thJK} for various conduction angles d :

d	R_{thJK} (K/W)
DC	0.330
180°	0.344
120°	0.355
60°	0.383
30°	0.421

Constants for Z_{thJK} calculation:

i	R_{thi} (K/W)	t_i (s)
1	0.0095	0.001
2	0.0175	0.065
3	0.203	0.4
4	0.1	1.29