



Photocopier

Product Data Sheet

LTV-816/ 826/ 846
(M, S, S-TA, S-TA1, S-TP)
Series

Spec No.: DS-70-97-0013

Effective Date: 01/26/2016

Revision: H

LITE-ON DCC

RELEASE

BNS-OD-FC001/A4

Photocoupler LTV-816 826 846 (M, S, S-TA, S-TA1, S-TP) Series

1. DESCRIPTION

1.1 Features

- Current transfer ratio (CTR : MIN. 50% at $I_F = 5\text{mA}$, $V_{CE} = 5\text{V}$)
- High input-output isolation voltage ($V_{iso} = 5,000\text{Vrms}$)
- Response time (t_r : TYP. $4\mu\text{s}$ at $V_{CE} = 2\text{V}$, $I_C = 2\text{mA}$, $R_L = 100\Omega$)
- Dual-in-line package :
 - LTV-816 : 1-channel type
 - LTV-826 : 2-channel type
 - LTV-846 : 4-channel type
- Wide lead spacing package :
 - LTV-816M : 1-channel type
 - LTV-826M : 2-channel type
 - LTV-846M : 4-channel type
- Surface mounting package :
 - LTV-816S : 1-channel type
 - LTV-826S : 2-channel type
 - LTV-846S : 4-channel type
- Tape and reel packaging :
 - LTV-816S -TA : 1-channel type
 - LTV-816S -TA1 : 1-channel type
 - LTV-816S -TP : 1-channel type
 - LTV-826S -TA : 2-channel type
 - LTV-826S -TA1 : 2-channel type
- Safety approval
 - UL 1577
 - VDE DIN EN60747-5-5 (VDE 0884-5)
 - CSA CA5A
 - CQC GB4943.1-2011/ GB8898-2011 (meet Altitude up to 5000m)
 - Nordic Safety (FIMKO/NEMKO/SEMKO/DEMKO)
 - BSI
- RoHS Compliance
 - All materials be used in device are followed EU RoHS directive (No.2002/95/EC).
- ESD pass HBM 8000V/MM2000V
- MSL class1

1.2 Applications

- Hybrid substrates that require high density mounting.
- Programmable controllers

Photocoupler LTV-816 826 846 (M, S, S-TA, S-TA1, S-TP) Series

2. PACKAGE DIMENSIONS

2.1 LTV-816

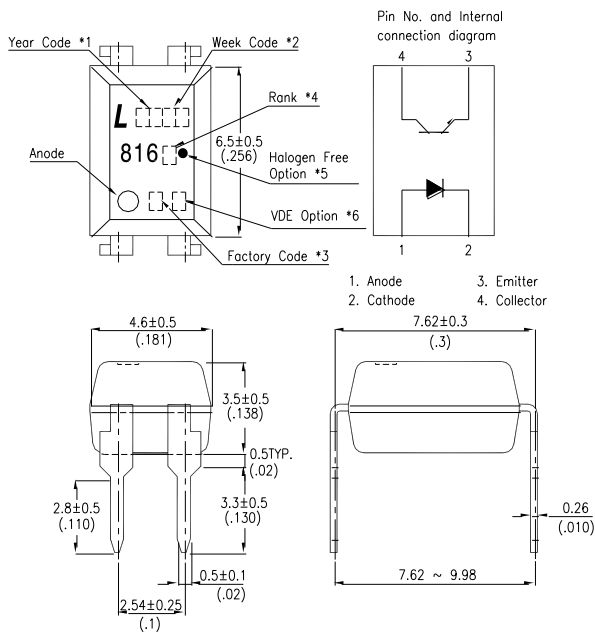

2.2 LTV-816M

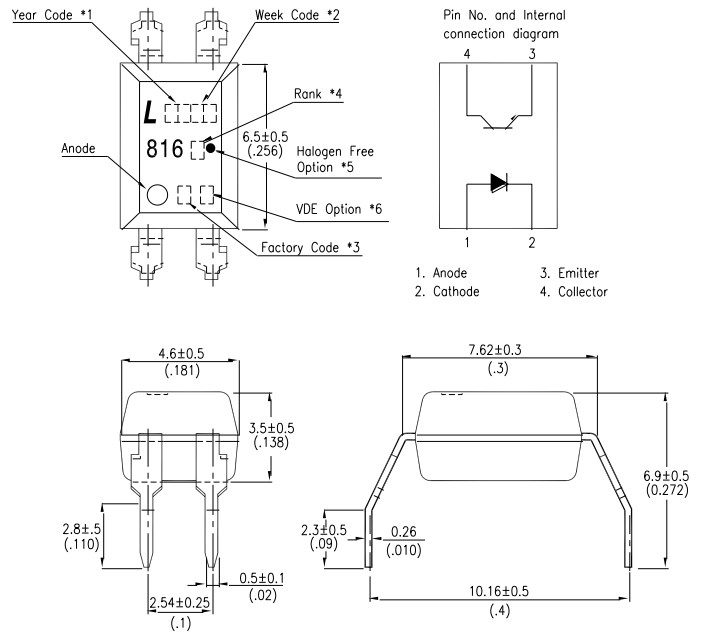

2.3 LTV-816S

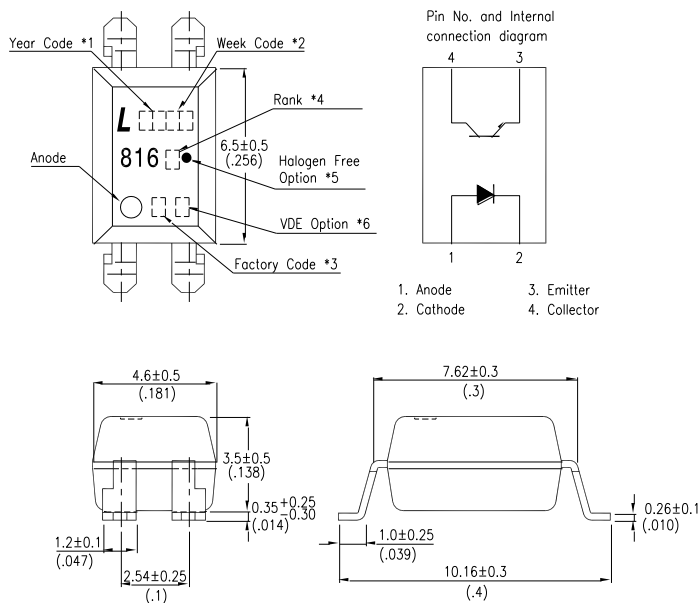

Notes :

1. Year date code.
2. 2-digit work week.
3. Factory identification mark shall be marked (W: China-CZ, Y: Thailand)
4. Rank shall be or shall not be marked.
5. "●" for halogen free option.
6. "4" or "V" for VDE option.

Dimensions in millimeters (inches).

Photocoupler LTV-816 826 846 (M, S, S-TA, S-TA1, S-TP) Series

2.4 LTV-826

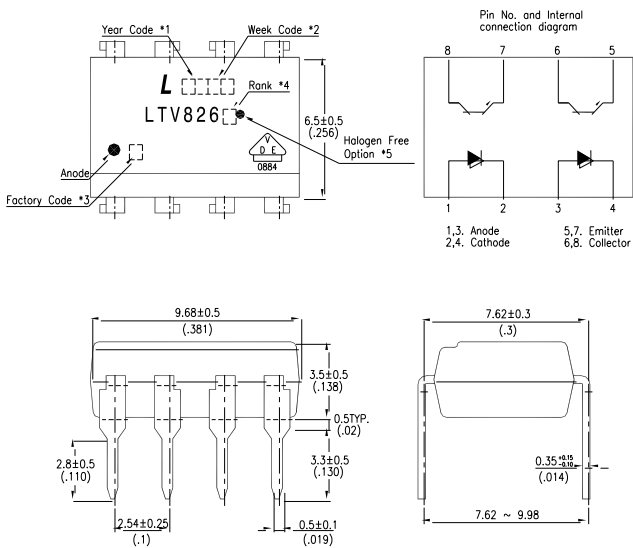

2.5 LTV-826M

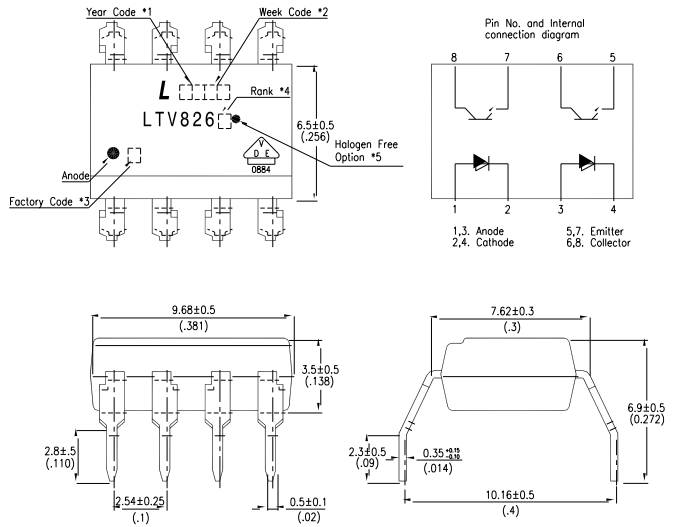

2.6 LTV-826S

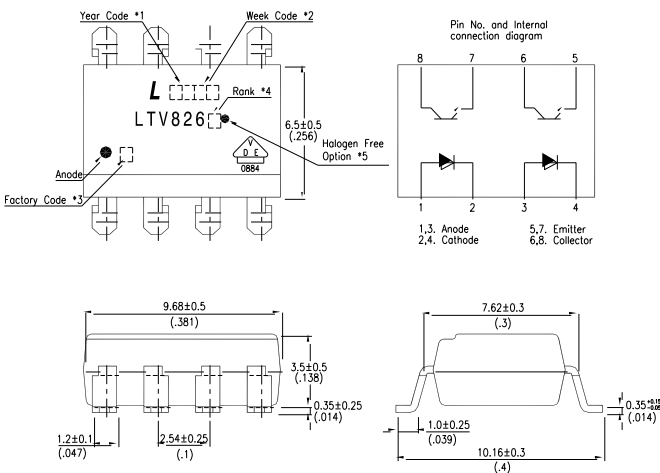

Notes :

1. Year date code.
2. 2-digit work week.
3. Factory identification mark shall be marked (W: China-CZ, Y: Thailand)
4. Rank shall be or shall not be marked.
5. "●" for halogen free option.

Dimensions in millimeters (inches).

Photocoupler LTV-816 826 846 (M, S, S-TA, S-TA1, S-TP) Series

2.7 LTV-846

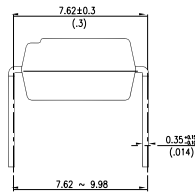
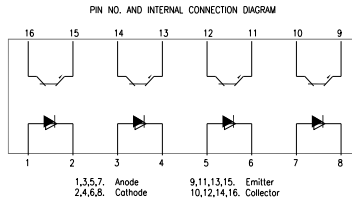
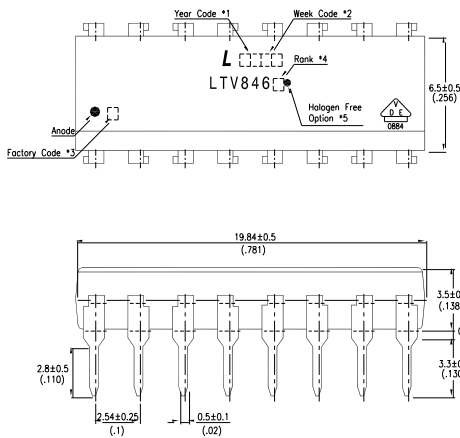

2.8 LTV-846M

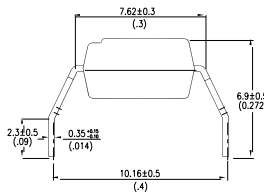
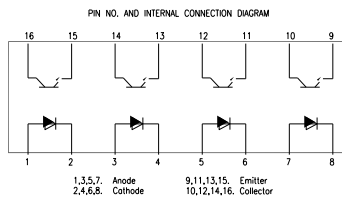
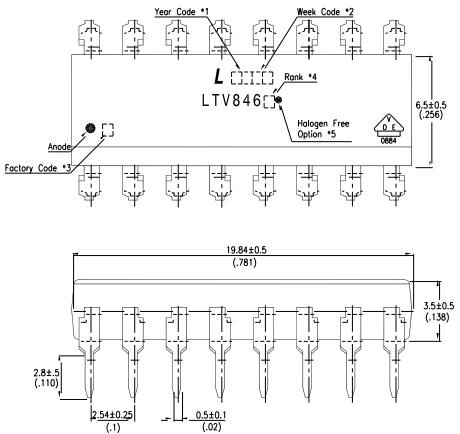

2.9 LTV-846S

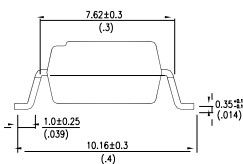
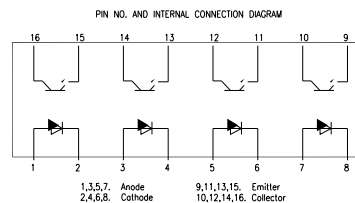
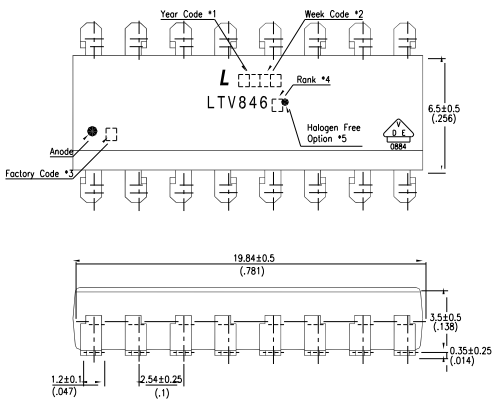

Notes :

1. Year date code.
2. 2-digit work week.
3. Factory identification mark shall be marked (W: China-CZ, Y: Thailand)
4. Rank shall be or shall not be marked.
5. "●" for halogen free option.

Dimensions in millimeters (inches).

Photocoupler LTV-816 826 846 (M, S, S-TA, S-TA1, S-TP) Series

3. TAPING DIMENSIONS

3.1 LTV-816S-TA

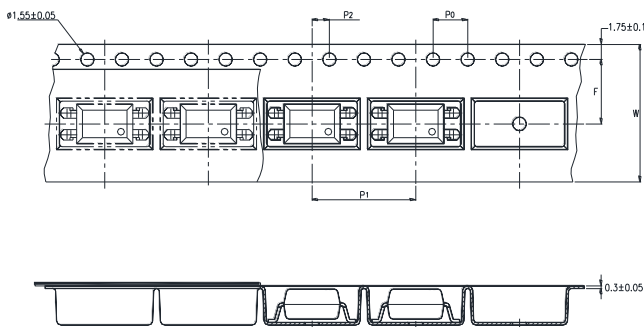

3.2 LTV-816S-TA1

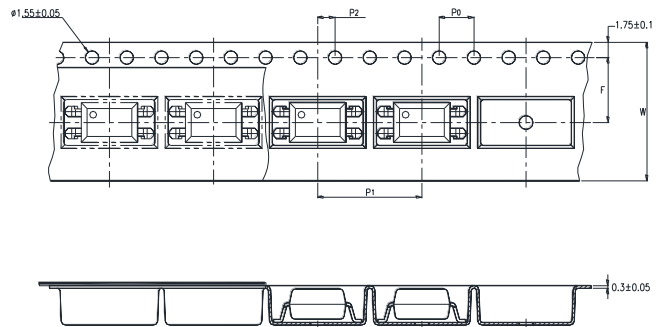

Description	Symbol	Dimension in mm (inch)
Tape wide	W	16±0.3 (0.63)
Pitch of sprocket holes	P ₀	4±0.1 (0.15)
Distance of compartment	F	7.5±0.1 (0.295)
	P ₂	2±0.1 (0.079)
Distance of compartment to compartment	P ₁	12±0.1 (0.472)

3.3 Quantities Per Reel

Package Type	T/A/TA1
Quantities (pcs)	1000

Photocoupler LTV-816 826 846 (M, S, S-TA, S-TA1, S-TP) Series

3.4 LTV-816S-TP

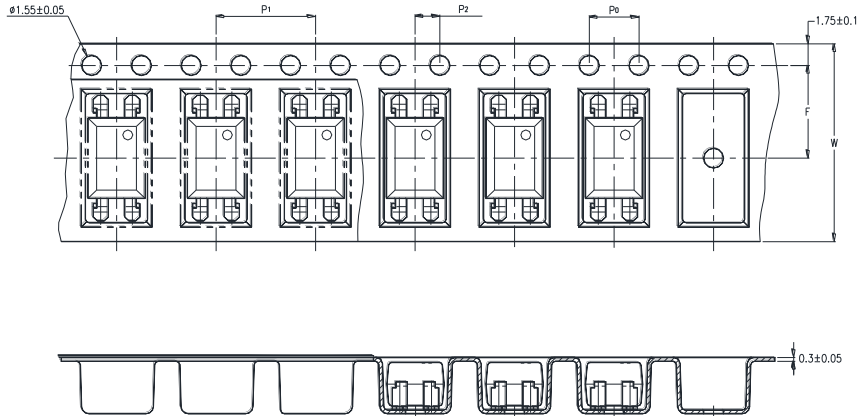

Description	Symbol	Dimension in mm (inch)
Tape wide	W	16±0.3 (0.63)
Pitch of sprocket holes	P ₀	4±0.1 (0.15)
Distance of compartment	F	7.5±0.1 (0.295)
	P ₂	2±0.1 (0.079)
Distance of compartment to compartment	P ₁	8±0.1 (0.472)

3.5 Quantities Per Reel

Package Type	TP
Quantities (pcs)	2000

Photocoupler LTV-816 826 846 (M, S, S-TA, S-TA1, S-TP) Series

3.6 LTV-826S-TA

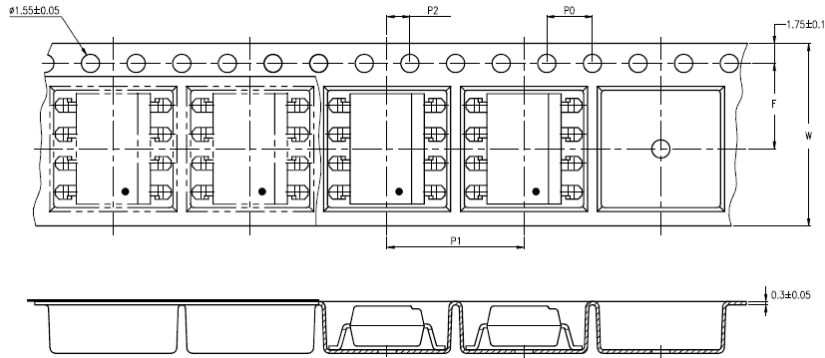

3.7 LTV-826S-TA1

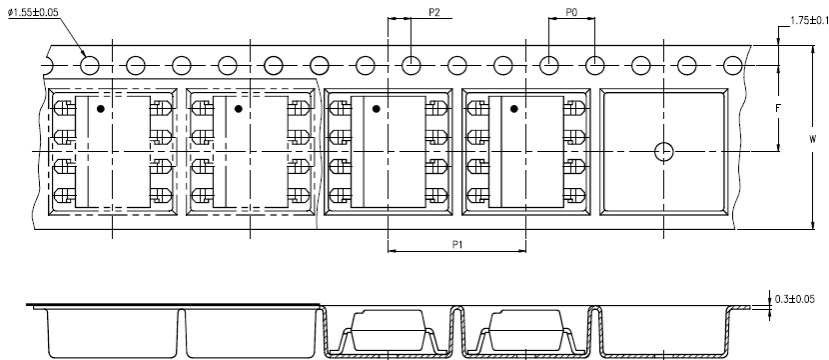

Description	Symbol	Dimension in mm (inch)
Tape wide	W	16±0.3 (0.63)
Pitch of sprocket holes	P ₀	4±0.1 (0.15)
Distance of compartment	F	7.5±0.1 (0.295)
	P ₂	2±0.1 (0.079)
Distance of compartment to compartment	P ₁	12±0.1 (0.47)

3.8 Quantities Per Reel

Package Type	TA/TA1
Quantities (pcs)	1000

Photocoupler

LTV-816 826 846 (M, S, S-TA, S-TA1, S-TP) Series

4. RATING AND CHARACTERISTICS

4.1 Absolute Maximum Ratings at Ta=25°C

	Parameter	Symbol	Rating	Unit
Input	Forward Current	I_F	50	mA
	Reverse Voltage	V_R	6	V
	Power Dissipation	P	70	mW
	Junction Temperature	T_J	125	°C
Output	Collector - Emitter Voltage	V_{CEO}	80	V
	Emitter - Collector Voltage	V_{ECO}	6	V
	Collector Current	I_C	50	mA
	Collector Power Dissipation	P_C	150	mW
	Total Power Dissipation	P_{tot}	200	mW
1.	Isolation Voltage	V_{iso}	5000	V_{rms}
	Operating Temperature (LTV-826/846)	T_{opr}	-30 ~ +100	°C
	Operating Temperature (LTV-816)	T_{opr}	-50 ~ +110	°C
	Storage Temperature	T_{stg}	-55 ~ +125	°C
2.	Soldering Temperature	T_{sol}	260	°C

1. AC For 1 Minute, R.H. = 40 ~ 60%

Isolation voltage shall be measured using the following method.

- (1) Short between anode and cathode on the primary side and between collector and emitter on the secondary side.
- (2) The isolation voltage tester with zero-cross circuit shall be used.
- (3) The waveform of applied voltage shall be a sine wave.

2. For 10 Seconds

Photocoupler LTV-816 826 846 (M, S, S-TA, S-TA1, S-TP) Series

4.2 ELECTRICAL OPTICAL CHARACTERISTICS at Ta=25°C

Parameter		Symbol	Min.	Typ.	Max.	Unit	Test Condition
Input	Forward Voltage	V_F	—	1.2	1.4	V	$I_F=20\text{mA}$
	Reverse Current	I_R	—	—	10	μA	$V_R=4\text{V}$
	Terminal Capacitance	C_t	—	30	250	pF	$V=0, f=1\text{KHz}$
Output	Collector Dark Current	I_{CEO}	—	—	100	nA	$V_{CE}=20\text{V}, I_F=0$
	Collector-Emitter Breakdown Voltage	BV_{CEO}	80	—	—	V	$I_C=0.1\text{mA}, I_F=0$
	Emitter-Collector Breakdown Voltage	BV_{ECO}	6	—	—	V	$I_E=10\mu\text{A}, I_F=0$
TRANSFER CHARACTERISTICS	Collector Current	I_C	2.5	—	30	mA	$I_F=5\text{mA}, V_{CE}=5\text{V}$
	1. Current Transfer Ratio	CTR	50	—	600	%	
	Collector-Emitter Saturation Voltage	$V_{CE(sat)}$	—	0.1	0.2	V	$I_F=20\text{mA}, I_C=1\text{mA}$
	Isolation Resistance	R_{iso}	5×10^{10}	1×10^{11}	—	Ω	DC500V, 40 ~ 60% R.H.
	Floating Capacitance	C_f	—	0.6	1	pF	$V=0, f=1\text{MHz}$
	Cut-off Frequency	f_c	—	80	—	kHz	$V_{CE}=5\text{V}, I_C=2\text{mA}$ $R_L=100\Omega, -3\text{dB}$
	Response Time (Rise)	t_r	—	4	18	μs	$V_{CE}=2\text{V}, I_C=2\text{mA}$
	Response Time (Fall)	t_f	—	3	18	μs	$R_L=100\Omega,$

$$1. \text{CTR} = \frac{I_C}{I_F} \times 100\%$$

**Photocoupler
LTV-816 826 846 (M, S, S-TA, S-TA1, S-TP) Series**

5. RANK TABLE OF CURRENT TRANSFER RATIO

	CTR Rank	Min	Max	Condition
LTV-816	L	50	100	I _F =5mA, V _{CE} =5V, T _a =25°C
	A	80	160	
	B	130	260	
	C	200	400	
	D	300	600	
	L or A or B or C or D	50	600	
LTV-826	No Bin	50	600	
	B	130	260	
	C	200	400	
	BC	130	400	
	CD	200	600	
LTV-846	No Bin	50	600	
	BC	130	400	
	CD	200	600	

Photocoupler LTV-816 826 846 (M, S, S-TA, S-TA1, S-TP) Series

6. CHARACTERISTICS CURVES

Fig.1 Forward Current vs. Ambient Temperature

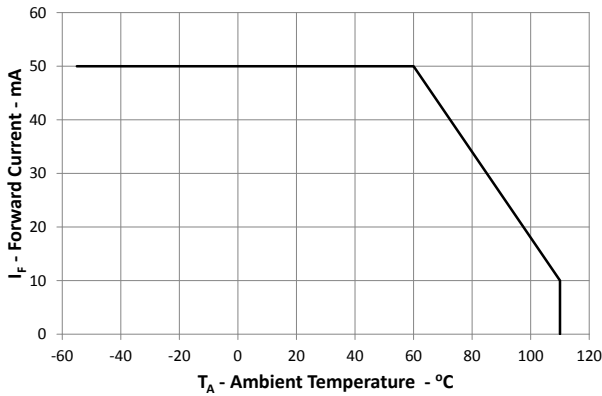

Fig.2 Collector Power Dissipation vs. Ambient Temperature

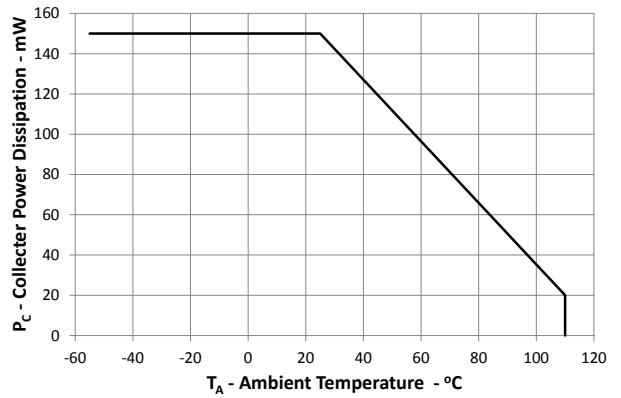

Fig.3 Collector-emitter Saturation Voltage vs. Forward Current

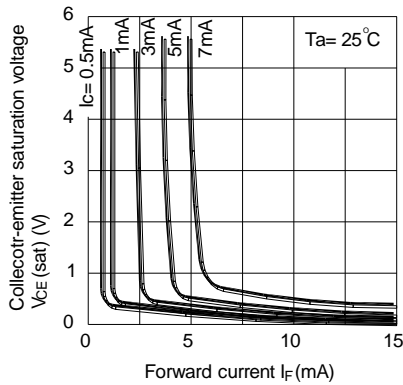

Fig.4 Forward Current vs. Forward Voltage

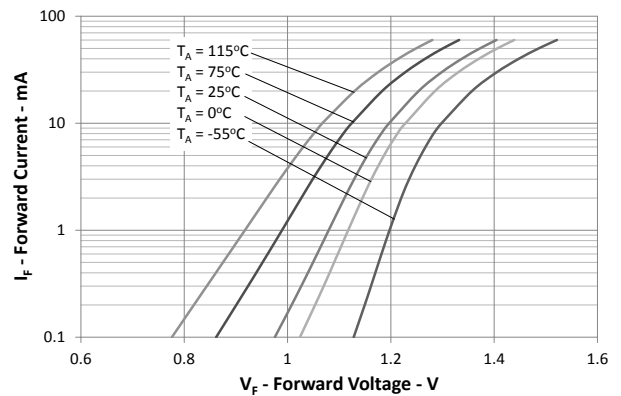

Fig.5 Normalized CTR vs. Forward Current

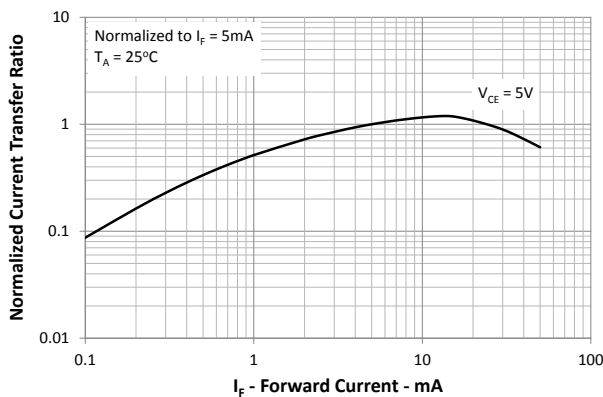
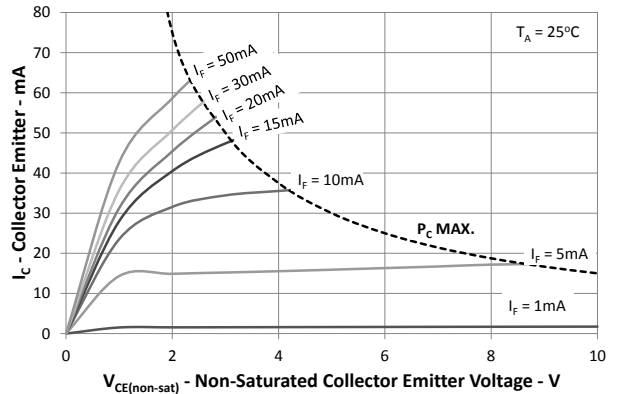

Fig.6 Collector Current vs. Collector-emitter Voltage



Photocoupler LTV-816 826 846 (M, S, S-TA, S-TA1, S-TP) Series

Fig.7 Relative Current Transfer Ratio vs. Ambient Temperature

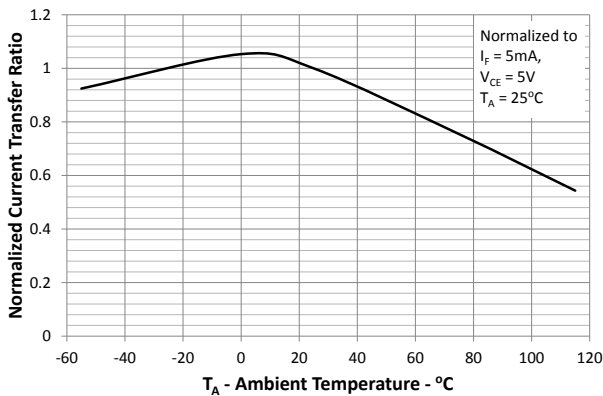

Fig.8 Collector-emitter Saturation Voltage vs. Ambient Temperature

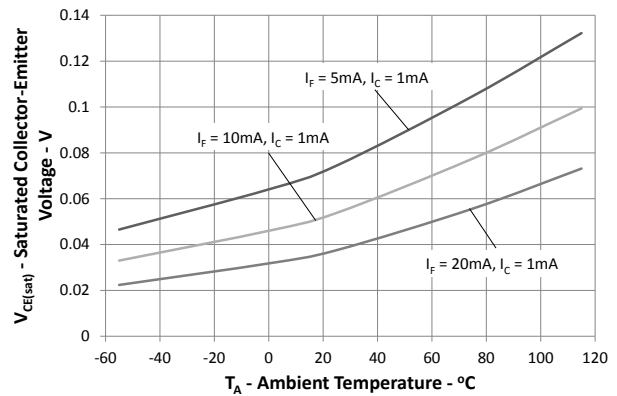

Fig.9 Collector Dark Current vs. Ambient Temperature

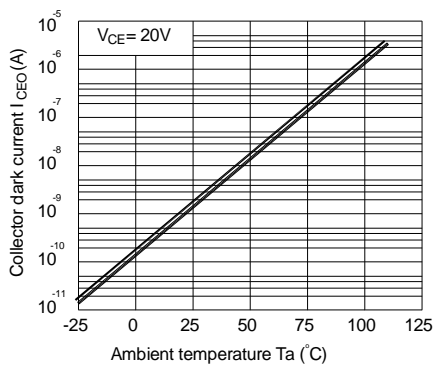

Fig.10 Response Time vs. Load Resistance

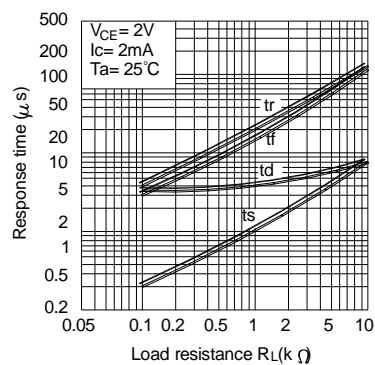
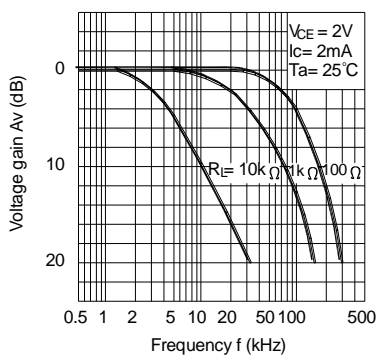
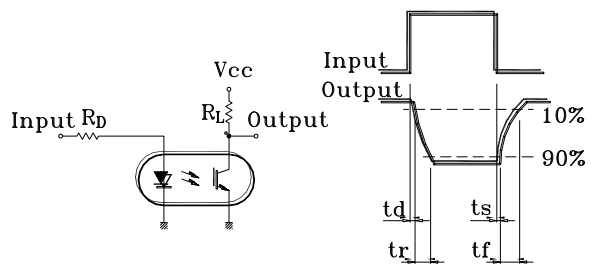

Fig.11 Frequency Response



Test Circuit for Response Time



Test Circuit for Frequency Response

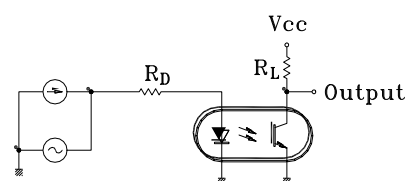

Photocoupler LTV-816 826 846 (M, S, S-TA, S-TA1, S-TP) Series

7. TEMPERATURE PROFILE OF SOLDERING

7.1 IR Reflow soldering (JEDEC-STD-020C compliant)

One time soldering reflow is recommended within the condition of temperature and time profile shown below. Do not solder more than three times.

Profile item	Conditions
Preheat	
- Temperature Min (T_{Smin})	150°C
- Temperature Max (T_{Smax})	200°C
- Time (min to max) (ts)	90±30 sec
Soldering zone	
- Temperature (T_L)	217°C
- Time (t_L)	60 sec
Peak Temperature (T_P)	260°C
Ramp-up rate	3°C / sec max.
Ramp-down rate	3~6°C / sec

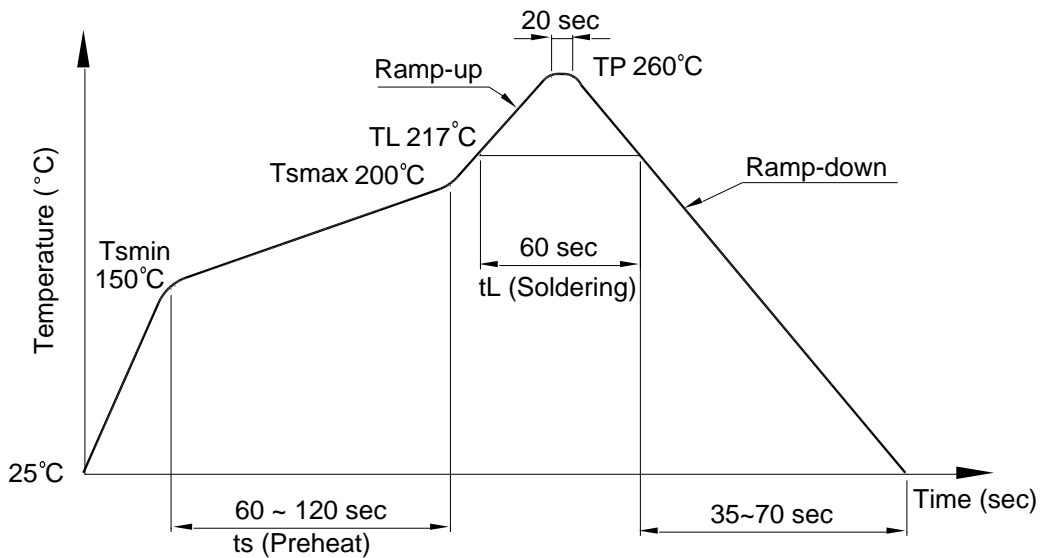

Photocoupler LTV-816 826 846 (M, S, S-TA, S-TA1, S-TP) Series

7.2 Wave soldering (JEDEC22A111 compliant)

One time soldering is recommended within the condition of temperature.

Temperature: $260 \pm 0 / -5^{\circ}\text{C}$

Time: 10 sec.

Preheat temperature: 25 to 140°C

Preheat time: 30 to 80 sec.

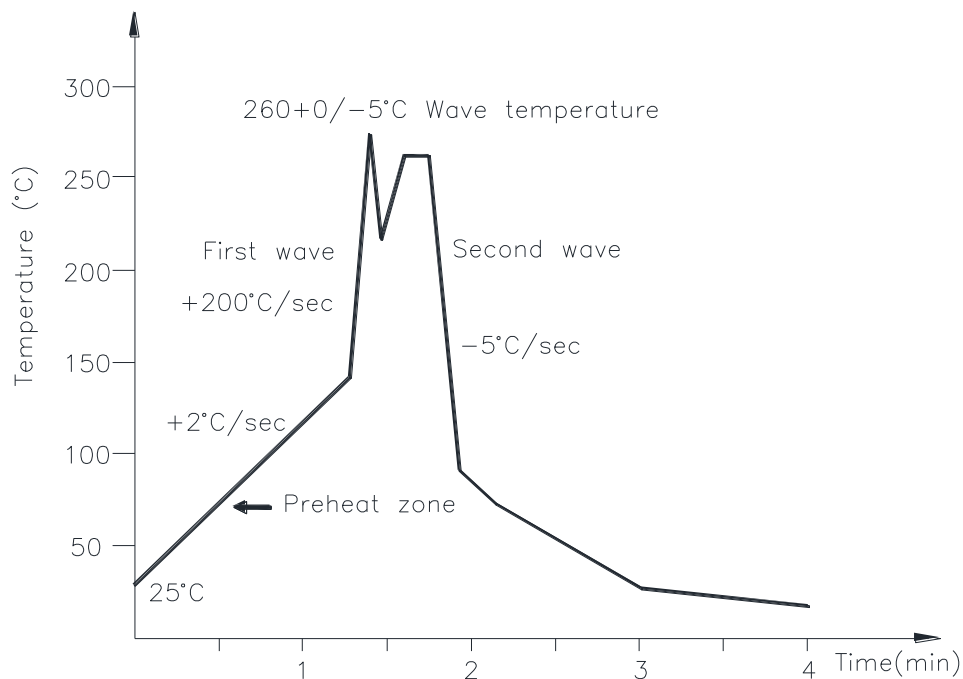

7.3 Hand soldering by soldering iron

Allow single lead soldering in every single process. One time soldering is recommended.

Temperature: $380 \pm 0 / -5^{\circ}\text{C}$

Time: 3 sec max.

**Photocoupler
LTV-816 826 846 (M, S, S-TA, S-TA1, S-TP) Series**

8. RRECOMMENDED FOOT PRINT PATTERNS (MOUNT PAD)

8.1 4 PIN

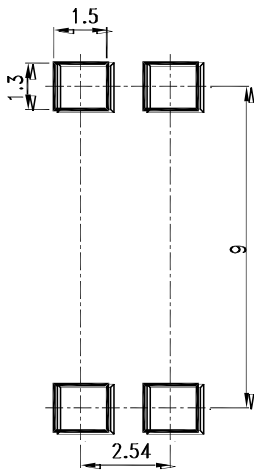

8.2 8 PIN

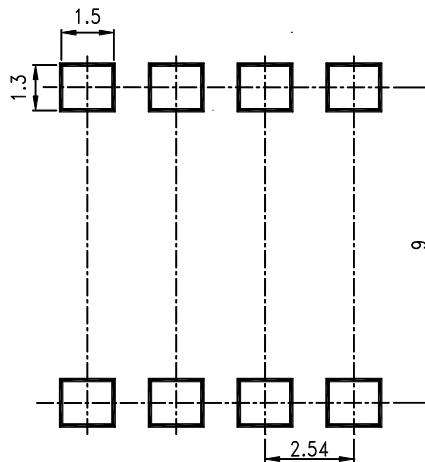

8.3 16 PIN

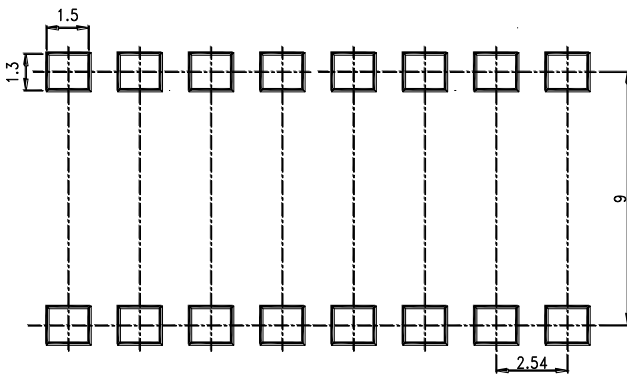

Note :

Dimensions in millimeters.

Photocoupler
LTV-816 826 846 (M, S, S-TA, S-TA1, S-TP) Series

9. Naming rule

LTV-8X6(1)-(2)-(3)-G

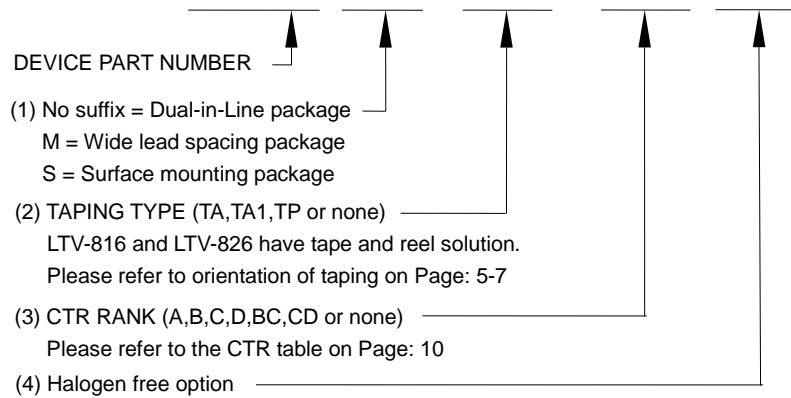

Example : LTV-816S-TA1-A-G, LTV-846S-BC

LTV8X6(1)(2)(3)-V-G

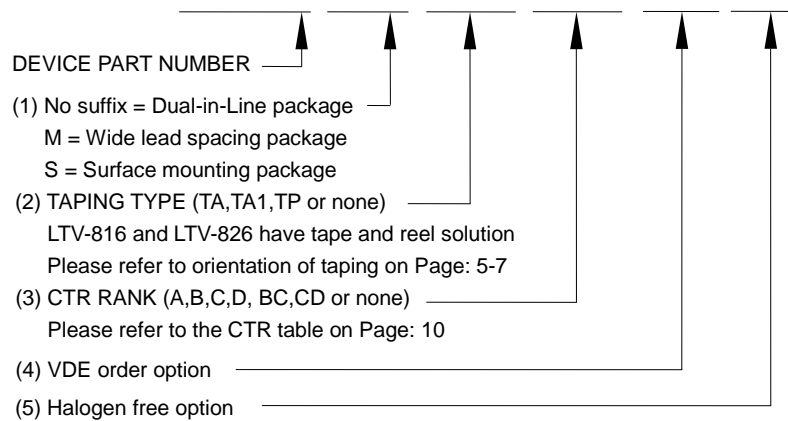

Example : LTV816STA1A-V-G, LTV846SBC-V

Photocoupler LTV-816 826 846 (M, S, S-TA, S-TA1, S-TP) Series

10. Notes:

- LiteOn is continually improving the quality, reliability, function or design and LiteOn reserves the right to make changes without further notices.
- The products shown in this publication are designed for the general use in electronic applications such as office automation equipment, communications devices, audio/visual equipment, electrical application and instrumentation.
- For equipment/devices where high reliability or safety is required, such as space applications, nuclear power control equipment, medical equipment, etc, please contact our sales representatives.
- When requiring a device for any "specific" application, please contact our sales in advice.
- If there are any questions about the contents of this publication, please contact us at your convenience.
- The contents described herein are subject to change without prior notice.
- Immerge unit's body in solder paste is not recommended.
- The contents described herein are subject to change without prior notice.
- Immerge unit's body in solder paste is not recommended.