



## Product Specification

### AUSHKXIN Type

### MBR20150CT

#### Features

---

- Plastic package has underwriters Laboratory Flammability Classification 94V-0
- For surface mounted application
- Metal of silicon rectifier, majority carrier conduction
- Low forward voltage, high efficiency
- Guarding for over voltage protection
- For use in low voltage, high frequency inverters, Free wheeling, and polarity protection applications

#### Mechanical Characteristics

---

- Case: Epoxy, Molded
- Weight: 1.9grams (approximately)
- Finish: All External Surfaces Corrosion Resistant and Terminal Leads are Readily Solderable
- Lead Temperature for Soldering Purposes: 260°C Max.for10 sec
- Shipped 50 units per plastic tube

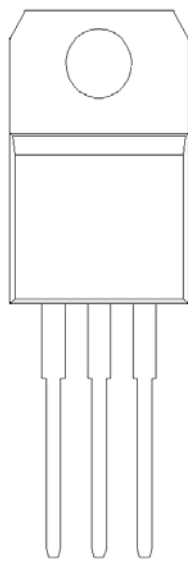

1 K 2

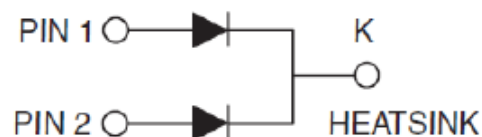

**SCHOTTKY BARRIER RECTIFIER**

**20 AMPERES**

**150 VOLTS**



### Maximum Ratings and Electrical Characteristics

TC=25°C unless otherwise noted

Parameter	Symbol	MBRF10100CT	Unit
Maximum repetitive peak reverse voltage	$V_{RRM}$	150	Volts
Working peak reverse voltage	$V_{RWM}$	150	Volts
Maximum DC blocking voltage	$V_{DC}$	150	Volts
Maximum average forward rectified current (See Fig. 1)	$I_{F(AV)}$	Total device 20 Per leg 10	Amps
Peak forward surge current 8.3ms single half sine-wave superimposed on rated load(JEDEC Method) per leg	$I_{FSM}$	135	Amps
Peak repetitive reverse current per leg at $t_p=2.0\mu s, 1KHz, T_J < 175^\circ C$	$I_{RRM}$	3.0	Amps
Voltage rate of change (rated $V_R$ )	$dv/dt$	10,000	V/ $\mu s$
Maximum instantaneous forward voltage per leg (Note 4) at $I_F=10A, TC=25^\circ C$ at $I_F=10A, TC=125^\circ C$	$V_F$	0.87 0.77	Volts
Maximum reverse current per leg at working peak reverse voltage (Note 4)	$I_R$	$T_J=25^\circ C, V_R=150V$ 5 $T_J=125^\circ C, V_R=150V$ 5	$\mu A$ mA
Typical thermal resistance per leg	$R_{\theta JC}$	4.0	$^\circ C/W$
Operating junction temperature range	$T_J$	-55 to +175	$^\circ C$
Storage temperature range	$T_{STG}$	-55 to +175	$^\circ C$
Electrostatic Discharge Voltage. JEDEC Method.ESD HBM.Contact.	$V_{ESD}$	$\pm 8$ (contact)	KV

- Notes:**
1. Clip mounting (on case), where lead does not overlap heatsink with 0.110" offset
  2. Clip mounting (on case), where leads do overlap heatsink
  3. Screw mounting with 4-40 screw, where washer diameter is < 4.9 mm (0.19")
  4. Pulse test: 300us pulse width, 1% duty cycle



## RATINGS AND CHARACTERISTIC CURVES

$T_A = 25^\circ\text{C}$  unless otherwise noted

**Fig.1-Forward Current Derating Curve**

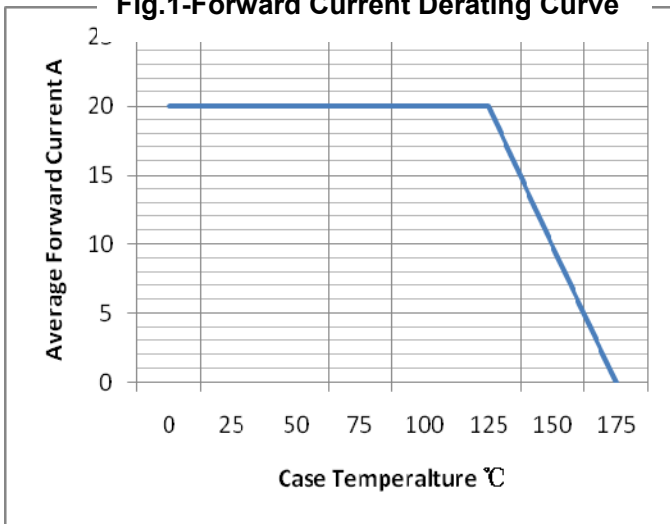

**Fig.2-Maximum Non-Repetitive Peak Forward Surge Current Per Leg**

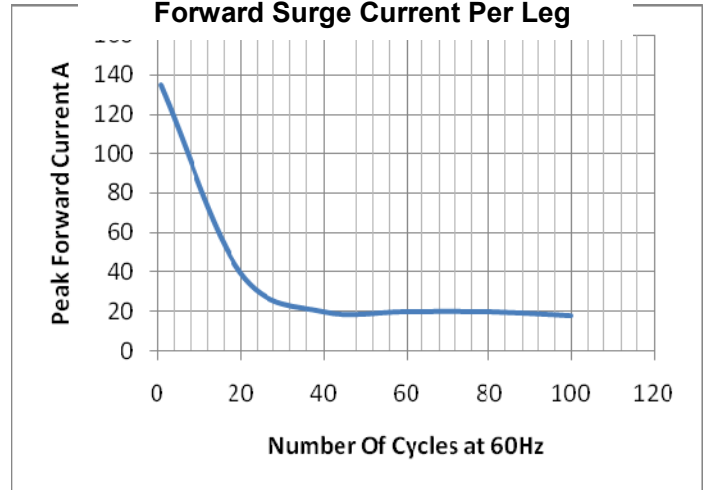

**Fig. 3 – Typical Instantaneous Forward Characteristics Per Leg**

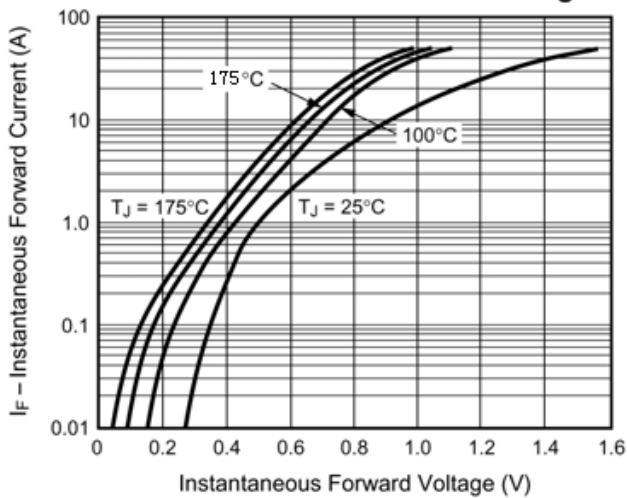

**Fig. 4 – Typical Reverse Characteristics Per Leg**

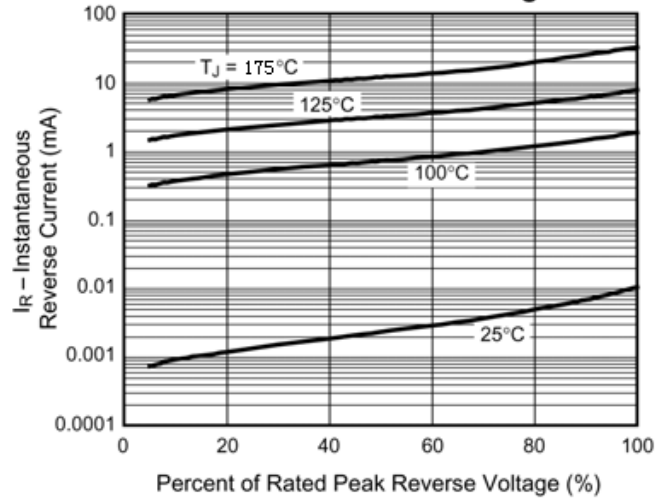

**Fig. 5 – Typical Transient Thermal Impedance Per Leg**

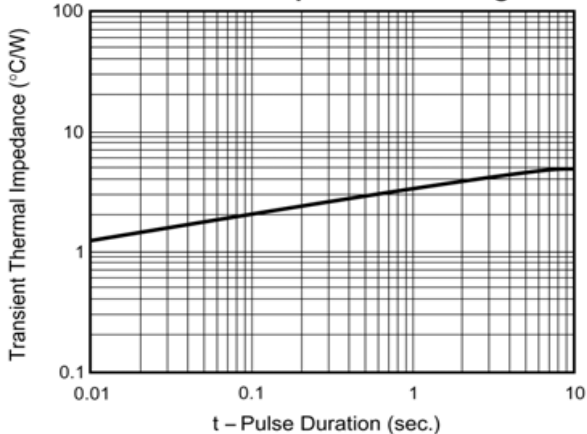



Package Outline (TO-220A)

UNIT:mm

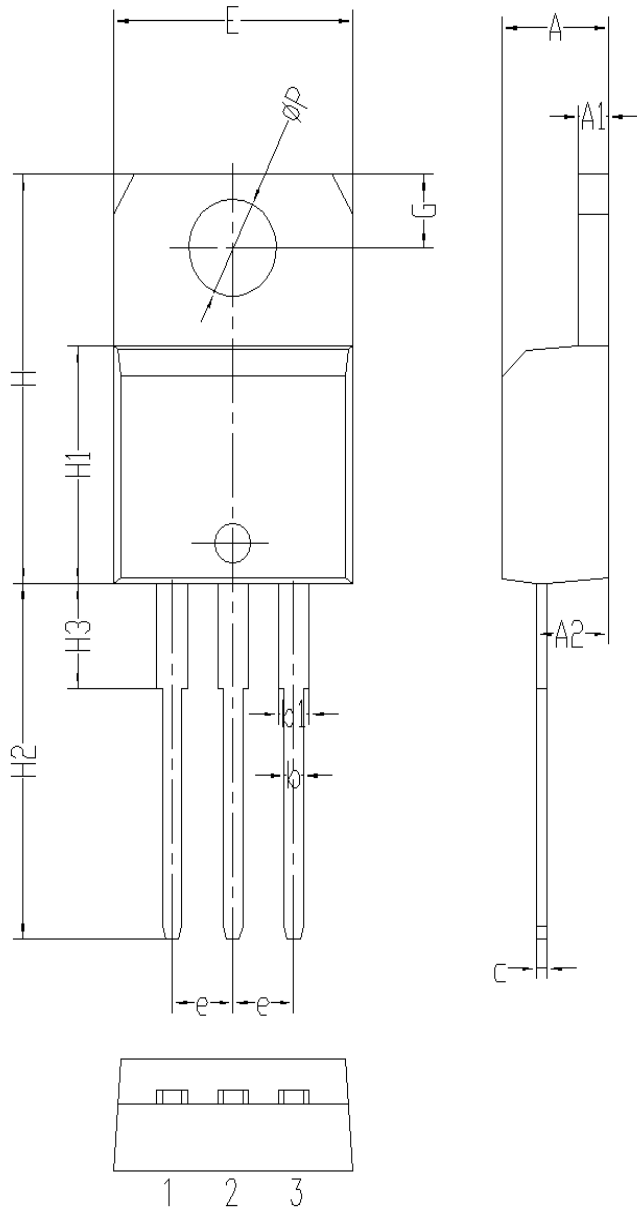

	单位: mm		
	MIN	NOM	MAX
A	4.05	4.25	4.45
A1	1.15	1.25	1.35
A2	2.35	2.55	2.75
b	0.70	0.80	0.90
b 1	1.12	1.32	1.52
c	0.30	0.45	0.60
e	2.34	2.54	2.74
E	9.95	10.15	10.35
H	15.3	15.5	15.7
H1	8.8	9	9.2
H2	13	13.5	14
H3	3.8	4	4.2
G	2.65	2.8	2.95
Ø	3.65	3.8	3.95