



# Photocoupler

## Product Data Sheet

LTV-814 824 844  
(M, S, S-TA, S-TA1, S-TP)  
Series

Spec No.: DS-70-96-0013

Effective Date: 05/21/2014

Revision: G

**LITE-ON DCC**

**RELEASE**

BNS-OD-FC001/A4

## Photocouplers LTV-814 824 844 (M, S, S-TA, S-TA1, S-TP) SERIES

### 1. DESCRIPTION

#### 1.1 Features

- Current transfer ratio ( CTR : MIN. 20% at  $I_F = \pm 1\text{mA}$ ,  $V_{CE} = 5\text{V}$  )
- Response time ( tr : TYP.  $4\mu\text{s}$  at  $V_{CE} = 2\text{V}$ ,  $I_C = 2\text{mA}$ ,  $R_L = 100\Omega$  )
- AC input response
- Low collector dark current (  $I_{CEO}$  :MAX.  $10^{-7}$  A at  $V_{CE}=20\text{V}$  )
- High input-output isolation voltage (  $V_{iso} = 5,000\text{Vrms}$  )
- Dual-in-line package :
  - LTV-814 : 1-Channel type
  - LTV-824 : 2-Channel type
  - LTV-844 : 4-Channel type
- Wide lead spacing package :
  - LTV-814M : 1-Channel type
  - LTV-824M : 2-Channel type
  - LTV-844M : 4-Channel type
- Surface mounting package :
  - LTV-814S : 1-Channel type
  - LTV-824S : 2-Channel type
  - LTV-844S : 4-Channel type
- Tape and reel packaging :
  - LTV-814S-TA, LTV-814S-TA1, LTV-814S-TP : 1-Channel type
  - LTV-824S-TA, LTV-824S-TA1 : 2-Channel type
- Safety approval
  - UL approved (No. E113898)
  - CSA approved (No. CA91533-1)
  - FIMKO approved (No. 193422-01)
  - VDE approved (No. 40015248)
- RoHS Compliance
- All materials be used in device are followed EU RoHS directive (No.2002/95/EC).
- ESD pass HBM 8000V/MM2000V
- MSL class1

#### 1.2 Applications

- AC line monitor
- Unknown polarity DC sensor
- Telephone line interface

# Photocouplers

## LTV-814 824 844 (M, S, S-TA, S-TA1, S-TP) SERIES

### 2. PACKAGE DIMENSIONS

#### 2.1 LTV-814 :

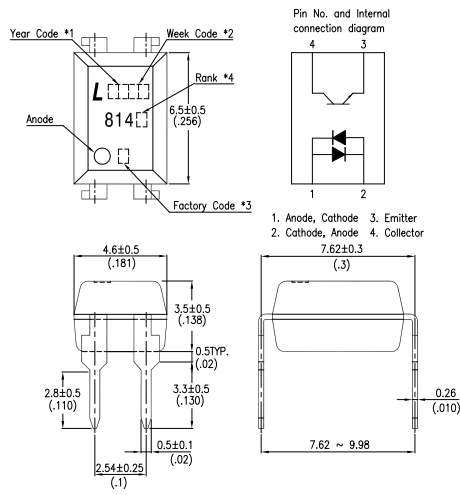

#### 2.2 LTV-824 :

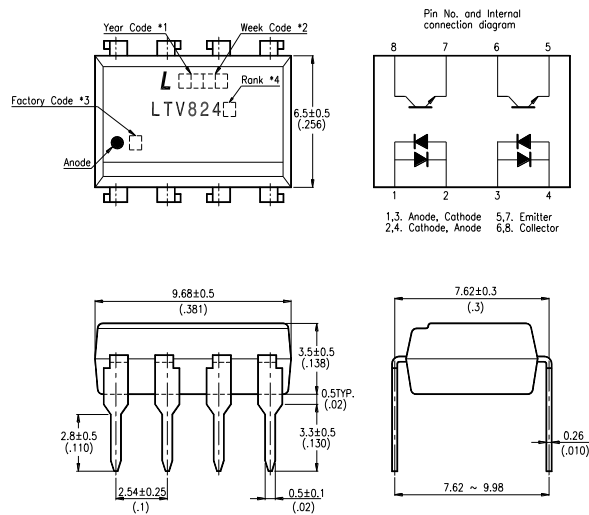

#### Notes :

1. Year date code.
2. 2-digit work week.
3. Factory identification mark shall be marked (Y: Thailand, W: China-CZ, X: China-TJ).
4. Rank shall be or shall not be marked.

## Photocouplers LTV-814 824 844 (M, S, S-TA, S-TA1, S-TP) SERIES

### 2.3 LTV-844 :

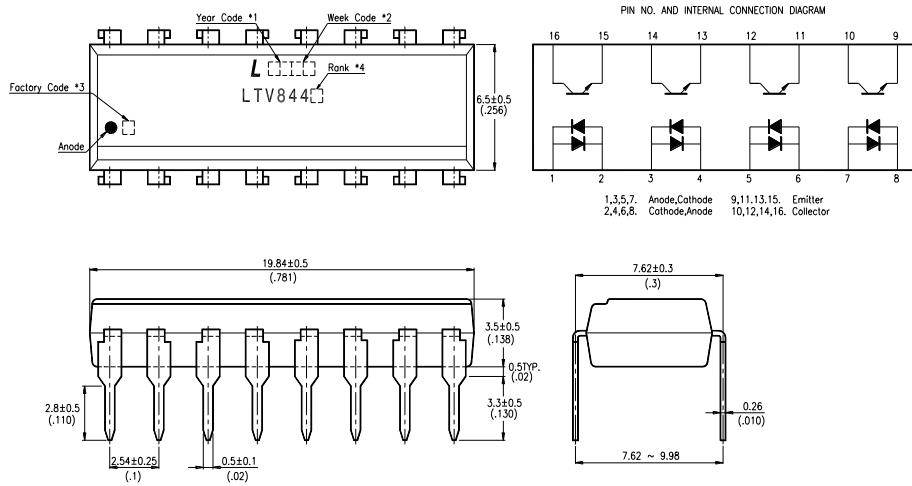

### 2.4 LTV-814M :

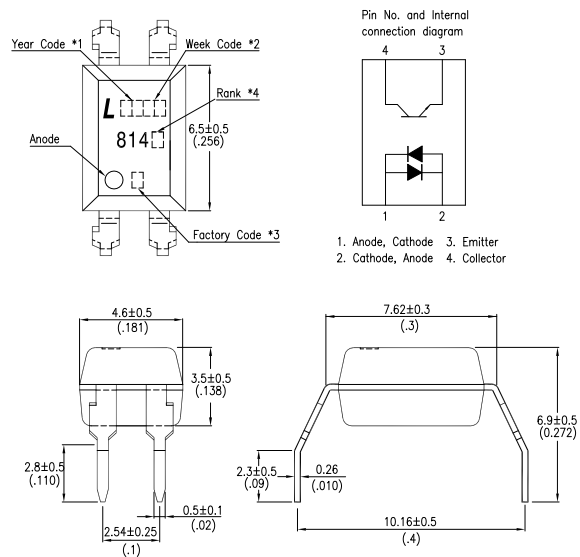

#### Notes :

1. Year date code.
2. 2-digit work week.
3. Factory identification mark shall be marked (Y: Thailand, W: China-CZ, X: China-TJ).
4. Rank shall be or shall not be marked.

## Photocouplers LTV-814 824 844 (M, S, S-TA, S-TA1, S-TP) SERIES

### 2.5 LTV-824M :

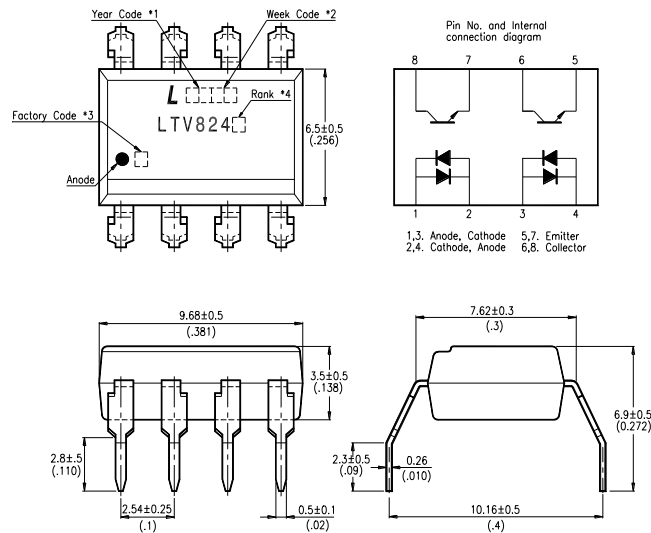

### 2.6 LTV-844M :

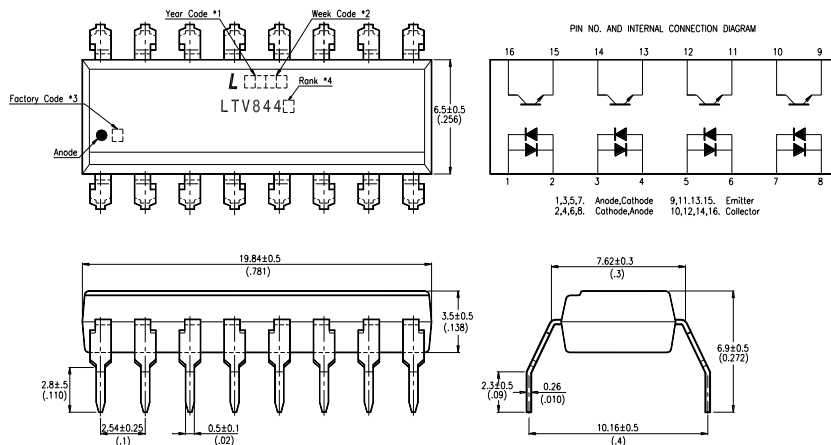

#### Notes :

1. Year date code.
2. 2-digit work week.
3. Factory identification mark shall be marked (Y: Thailand, W: China-CZ, X: China-TJ).
4. Rank shall be or shall not be marked.

## Photocouplers LTV-814 824 844 (M, S, S-TA, S-TA1, S-TP) SERIES

### 2.7 LTV-814S :

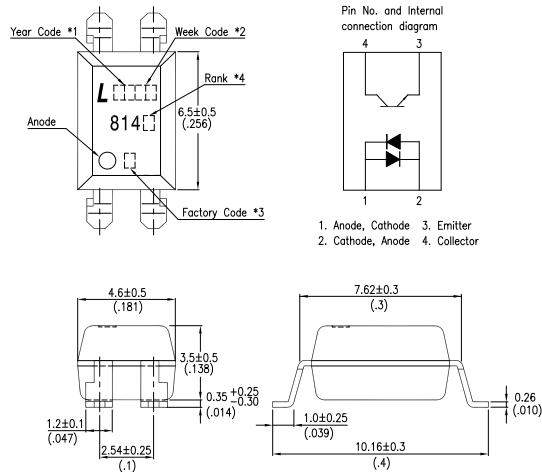

### 2.8 LTV-824S :

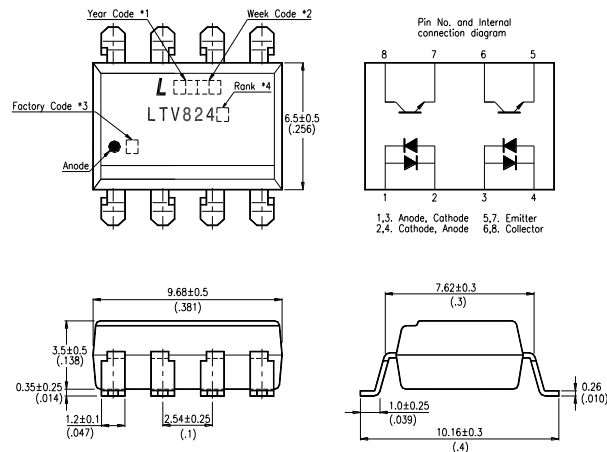

#### Notes :

1. Year date code.
2. 2-digit work week.
3. Factory identification mark shall be marked (Y: Thailand, W: China-CZ, X: China-TJ).
4. Rank shall be or shall not be marked.

# Photocouplers

## LTV-814 824 844 (M, S, S-TA, S-TA1, S-TP) SERIES

### 2.9 LTV-844S :

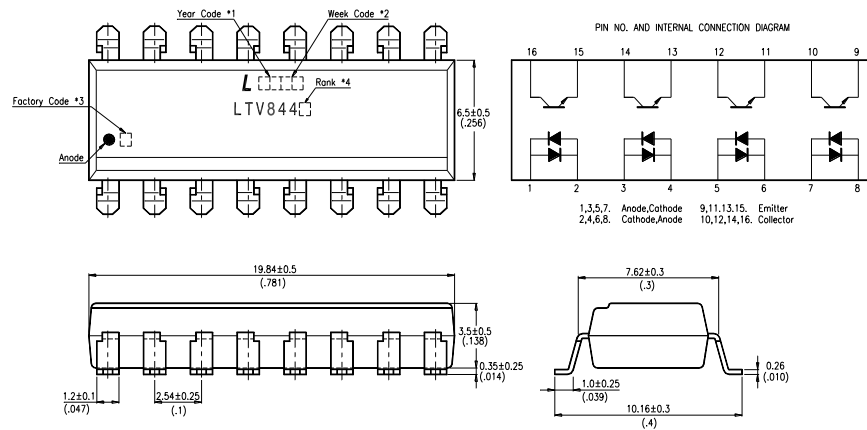

#### Notes :

1. Year date code.
2. 2-digit work week.
3. Factory identification mark shall be marked (Y: Thailand, W: China-CZ, X: China-TJ).
4. Rank shall be or shall not be marked.

## Photocouplers LTV-814 824 844 (M, S, S-TA, S-TA1, S-TP) SERIES

### 3. TAPING DIMENSIONS

#### 3.1 LTV-814S-TA :

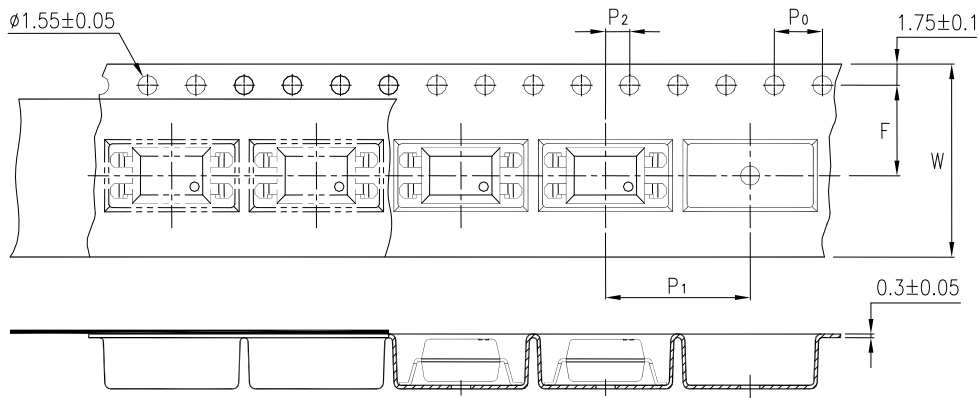

#### 3.2 LTV-814S-TA1 :

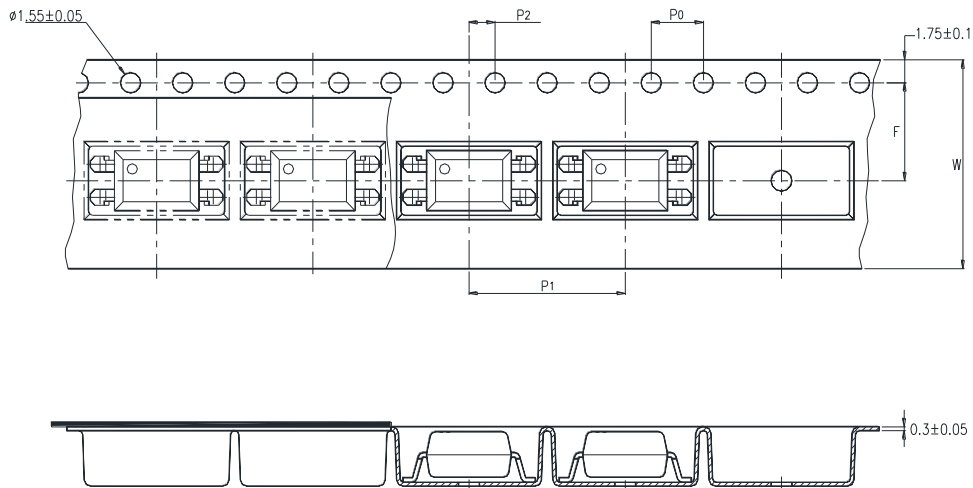

Description	Symbol	Dimension in mm (inch)
Tape wide	W	16±0.3 (0.63)
Pitch of sprocket holes	P <sub>0</sub>	4±0.1 (0.15)
Distance of compartment	F	7.5±0.1 (0.295)
	P <sub>2</sub>	2±0.1 (0.079)
Distance of compartment to compartment	P <sub>1</sub>	12±0.1 (0.472)



## Photocouplers LTV-814 824 844 (M, S, S-TA, S-TA1, S-TP) SERIES

### 3.3 LTV-814S-TP :

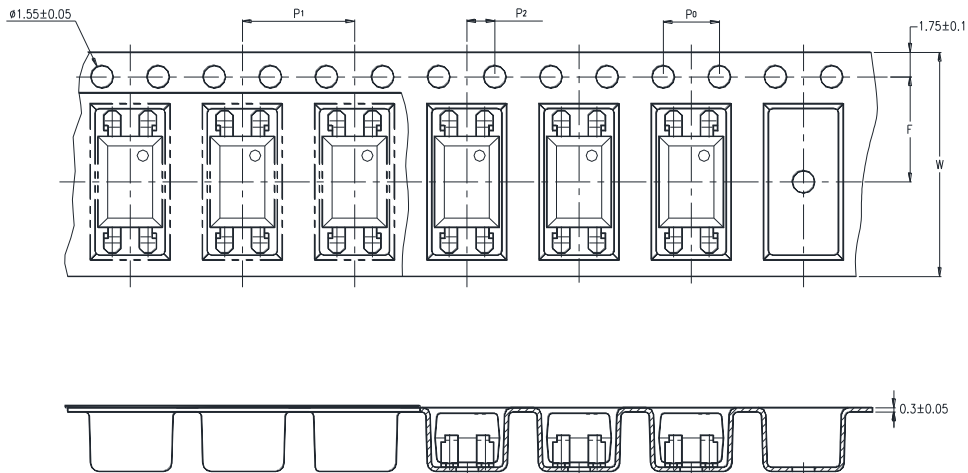

Description	Symbol	Dimension in mm (inch)
Tape wide	W	16±0.3 (0.63)
Pitch of sprocket holes	P <sub>0</sub>	4±0.1 (0.15)
Distance of compartment	F	7.5±0.1 (0.295)
	P <sub>2</sub>	2±0.1 (0.079)
Distance of compartment to compartment	P <sub>1</sub>	8±0.1 (0.316)

## Photocouplers LTV-814 824 844 (M, S, S-TA, S-TA1, S-TP) SERIES

### 3.4 LTV-824S-TA :

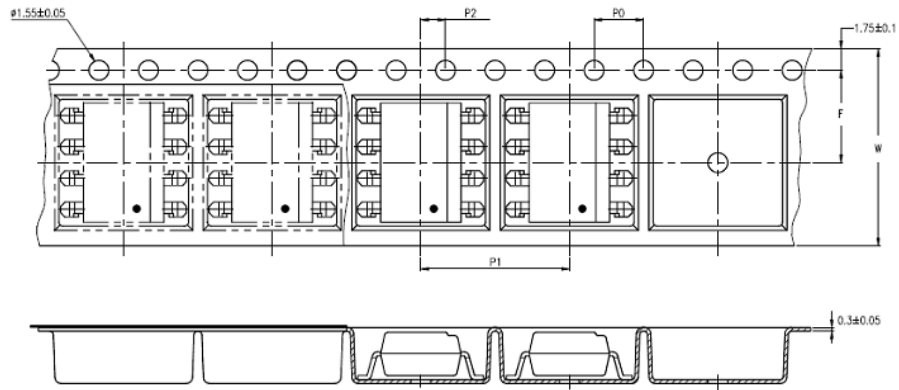

### 3.5 LTV-824S-TA1 :

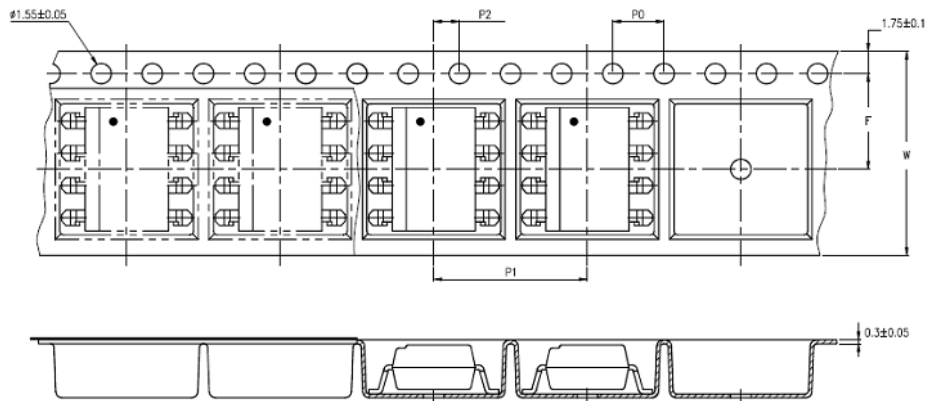

Description	Symbol	Dimension in mm (inch)
Tape wide	W	$16 \pm 0.3$ (0.63)
Pitch of sprocket holes	$P_0$	$4 \pm 0.1$ (0.15)
Distance of compartment	F	$7.5 \pm 0.1$ (0.295)
	$P_2$	$2 \pm 0.1$ (0.079)
Distance of compartment to compartment	$P_1$	$12 \pm 0.1$ (0.472)

## Photocouplers LTV-814 824 844 (M, S, S-TA, S-TA1, S-TP) SERIES

### 4. RATING AND CHARACTERISTICS

#### 4.1 Absolute Maximum Ratings at Ta=25°C

Parameter		Symbol	Rating	Unit
Input	Forward Current	$I_F$	$\pm 50$	mA
	Power Dissipation	P	70	mW
Output	Collector - Emitter Voltage	$V_{CEO}$	35	V
	Emitter - Collector Voltage	$V_{ECO}$	6	V
	Collector Current	$I_C$	50	mA
	Collector Power Dissipation	$P_C$	160	mW
Total Power Dissipation		$P_{tot}$	200	mW
*1 Isolation Voltage		$V_{iso}$	5000	$V_{rms}$
Operating Temperature (LTV-824 / 844)		$T_{opr}$	-30 ~ +100	°C
Operating Temperature (LTV-814)		$T_{opr}$	-30 ~ +110	°C
Storage Temperature		$T_{stg}$	-55 ~ +150	°C
*2 Soldering Temperature		$T_{sol}$	260	°C

\*1. AC For 1 Minute, R.H. = 40 ~ 60%

Isolation voltage shall be measured using the following method.

- (1) Short between anode and cathode on the primary side and between collector and emitter on the secondary side.
- (2) The isolation voltage tester with zero-cross circuit shall be used.
- (3) The waveform of applied voltage shall be a sine wave.

\*2. For 10 Seconds

## Photocouplers LTV-814 824 844 (M, S, S-TA, S-TA1, S-TP) SERIES

### 4.2 ELECTRICAL OPTICAL CHARACTERISTICS at Ta=25°C

PARAMETER		SYMBOL	MIN.	TYP.	MAX.	UNIT	CONDITIONS
INPUT	Forward Voltage	V <sub>F</sub>	—	1.2	1.4	V	IF=±20mA
	Terminal Capacitance	C <sub>t</sub>	—	50	250	pF	V=0, f=1KHz
OUTPUT	Collector Dark Current	I <sub>CEO</sub>	—	—	100	nA	VCE=20V, IF=0
	Collector-Emitter Breakdown Voltage	B <sub>VCEO</sub>	35	—	—	V	IC=0.1mA IF=0
	Emitter-Collector Breakdown Voltage	B <sub>VECO</sub>	6	—	—	V	IE=10μA IF=0
TRANSFER CHARACTERISTICS	Collector Current	IC	0.2	—	3	mA	IF=±1mA
	*Current Transfer Ratio	CTR	20	—	300	%	VCE=5V
	Collector-Emitter Saturation Voltage	V <sub>CE(sat)</sub>	—	0.1	0.2	V	IF=±20mA IC=1mA
	Isolation Resistance	Riso	5×10 <sup>10</sup>	1×10 <sup>11</sup>	—	Ω	DC500V 40 ~ 60% R.H.
	Floating Capacitance	Cf	—	0.6	1	pF	V=0, f=1MHz
	Response Time (Rise)	tr	—	4	18	μs	VCE=2V, IC=2mA
	Response Time (Fall)	tf	—	3	18	μs	RL=100Ω

$$*CTR = \frac{I_C}{I_F} \times 100\%$$

**Photocouplers**  
**LTV-814 824 844 (M, S, S-TA, S-TA1, S-TP) SERIES**

**4.3 RANK TABLE OF CURRENT TRANSFER RATIO CTR**

MODEL NO.	RANK MARK	CTR (%)
LTV-814	A	50 ~ 150
	B	100 ~ 300
	A or B or No mark	20 ~ 300
LTV-824/844	No mark	20 ~ 300

<b>CONDITIONS</b>	$I_F = \pm 1 \text{ mA}$ $V_{CE} = 5 \text{ V}$ $T_a = 25 \text{ }^\circ\text{C}$
-------------------	---

# Photocouplers LTV-814 824 844 (M, S, S-TA, S-TA1, S-TP) SERIES

## 5. CHARACTERISTICS CURVES

Fig.1 Forward Current vs. Ambient Temperature

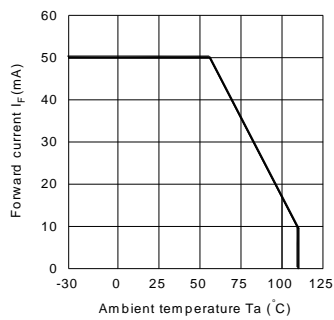

Fig.2 Collector Power Dissipation vs. Ambient Temperature

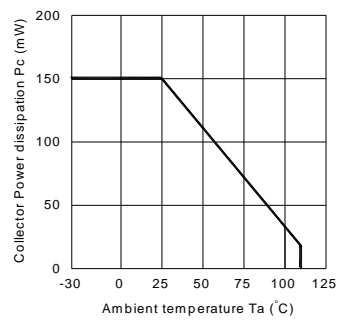

Fig.3 Collector-emitter Saturation Voltage vs. Forward Current

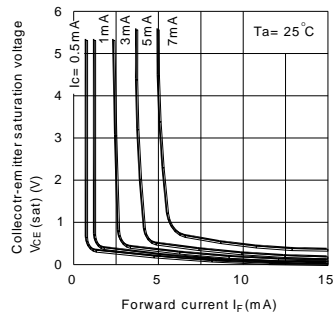

Fig.4 Forward Current vs. Forward Voltage

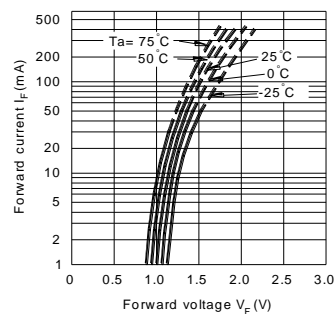

Fig.5 Current Transfer Ratio vs. Forward Current

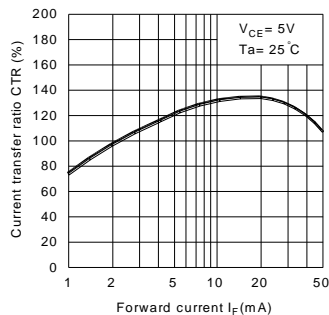
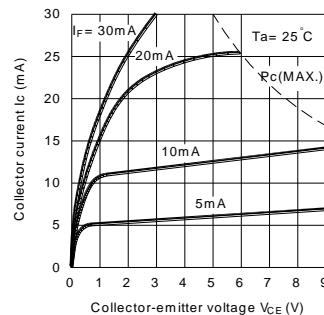

Fig.6 Collector Current vs. Collector-emitter Voltage



## Photocouplers LTV-814 824 844 (M, S, S-TA, S-TA1, S-TP) SERIES

Fig.7 Relative Current Transfer Ratio vs. Ambient Temperature

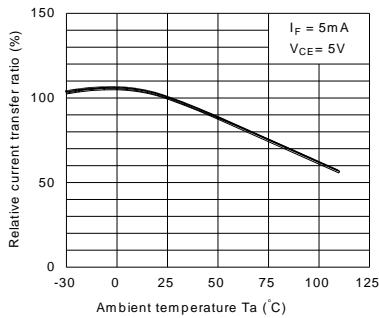

Fig.8 Collector-emitter Saturation Voltage vs. Ambient Temperature

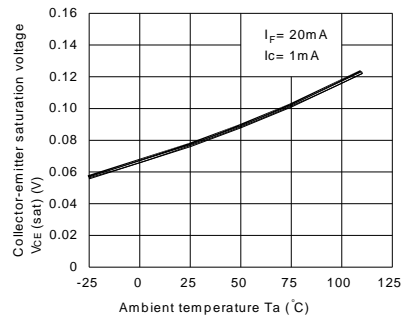

Fig.9 Collector Dark Current vs. Ambient Temperature

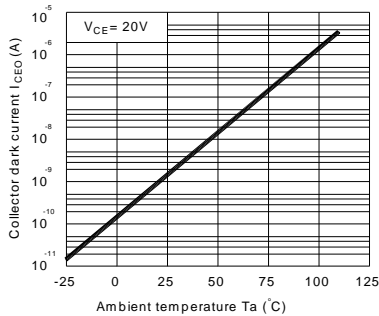

Fig.10 Response Time vs. Load Resistance

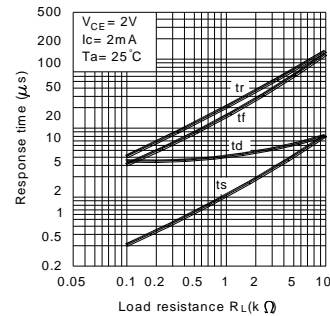
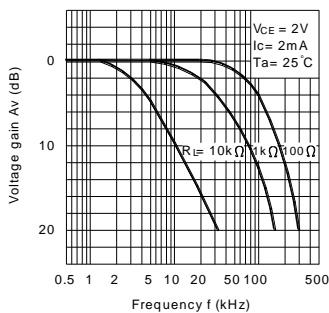
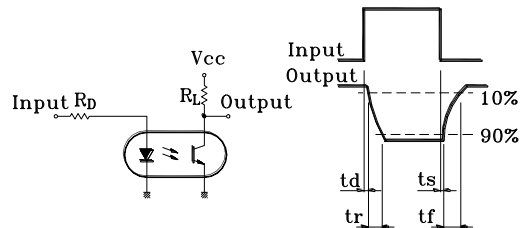

Fig.11 Frequency Response



Test Circuit for Response Time



Test Circuit for Frequency Response

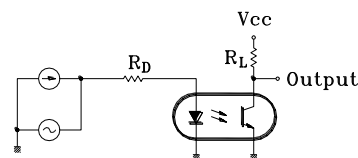

## Photocouplers LTV-814 824 844 (M, S, S-TA, S-TA1, S-TP) SERIES

### 6. TEMPERATURE PROFILE OF SOLDERING

#### 6.1 IR Reflow soldering (JEDEC-STD-020C compliant)

One time soldering reflow is recommended within the condition of temperature and time profile shown below. Do not solder more than three times.

Profile item	Conditions
Preheat	
- Temperature Min ( $T_{Smin}$ )	150°C
- Temperature Max ( $T_{Smax}$ )	200°C
- Time (min to max) (ts)	90±30 sec
Soldering zone	
- Temperature ( $T_L$ )	217°C
- Time ( $t_L$ )	60 sec
Peak Temperature ( $T_P$ )	260°C
Ramp-up rate	3°C / sec max.
Ramp-down rate	3~6°C / sec

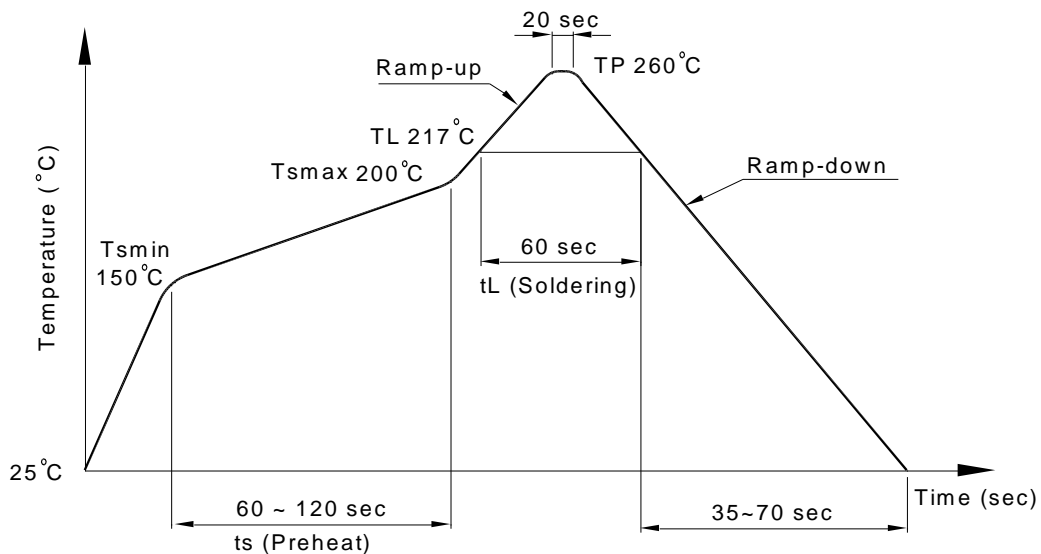



## Photocouplers LTV-814 824 844 (M, S, S-TA, S-TA1, S-TP) SERIES

### 6.2 Wave soldering (JEDEC22A111 compliant)

One time soldering is recommended within the condition of temperature.

Temperature:  $260 \pm 0 / -5^{\circ}\text{C}$

Time: 10 sec.

Preheat temperature: 25 to  $140^{\circ}\text{C}$

Preheat time: 30 to 80 sec.

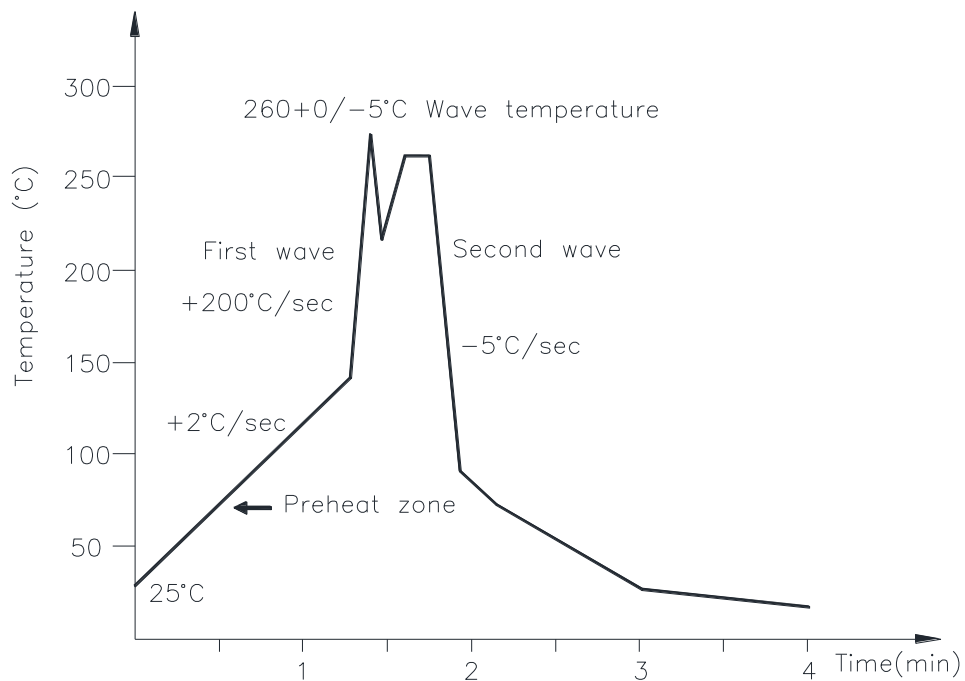

### 6.3 Hand soldering by soldering iron

Allow single lead soldering in every single process. One time soldering is recommended.

Temperature:  $380 \pm 0 / -5^{\circ}\text{C}$

Time: 3 sec max.

**Photocouplers**  
**LTV-814 824 844 (M, S, S-TA, S-TA1, S-TP) SERIES**

**7. RRECOMMENDED FOOT PRINT PATTERNS (MOUNT PAD)**

Unit: mm

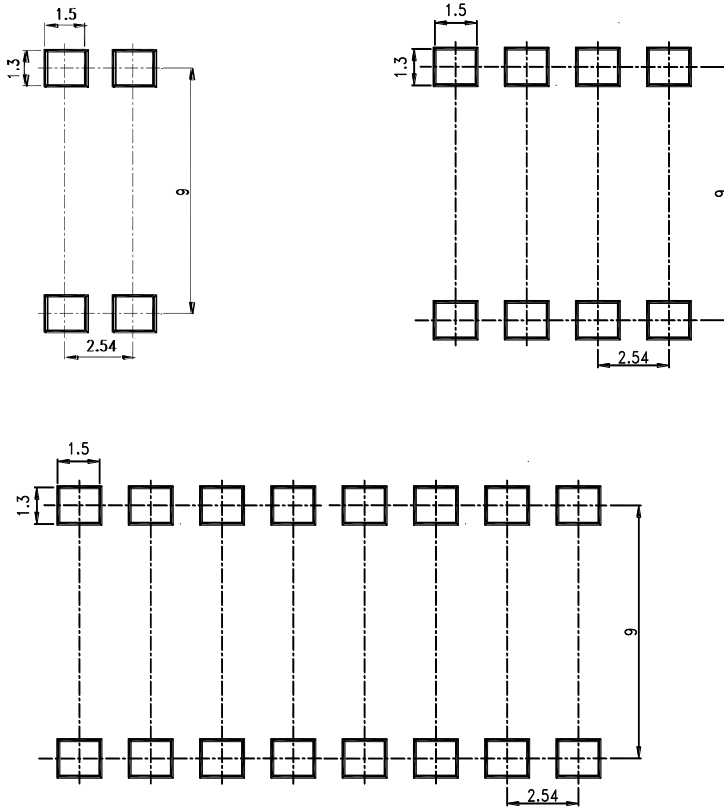

**8. NAMING RULE**

**LTV-8XX(1)-(2)**

DEVICE PART NUMBER

(1)= FORM TYPE (S, M or none)

(2)= TAPING TYPE (TA, TA1, TP or none)

## Photocouplers LTV-814 824 844 (M, S, S-TA, S-TA1, S-TP) SERIES

### 9. Notes:

- LiteOn is continually improving the quality, reliability, function or design and LiteOn reserves the right to make changes without further notices.
- The products shown in this publication are designed for the general use in electronic applications such as office automation equipment, communications devices, audio/visual equipment, electrical application and instrumentation.
- For equipment/devices where high reliability or safety is required, such as space applications, nuclear power control equipment, medical equipment, etc, please contact our sales representatives.
- When requiring a device for any "specific" application, please contact our sales in advice.
- If there are any questions about the contents of this publication, please contact us at your convenience.
- The contents described herein are subject to change without prior notice.
- Immerge unit's body in solder paste is not recommended.