



SINGLE P-CHANNEL POWER MOSFET

■ **DESCRIPTION**

The **UT2955** uses advanced trench technology to provide excellent $R_{DS(ON)}$, low gate charge and operation with low gate voltages. This device is suitable for use as a load switch, in PWM applications, converters and power supplies.

■ **FEATURES**

- * $R_{DS(ON)} < 170m\Omega @ V_{GS}=-10V, I_D=-0.75A$
- * $R_{DS(ON)} < 180m\Omega @ V_{GS}=-10V, I_D=-1.5A$
- * $R_{DS(ON)} < 185m\Omega @ V_{GS}=-10V, I_D=-2.4A$
- * Low Capacitance
- * Low Gate Charge
- * Fast Switching Capability
- * Avalanche Energy Specified

■ **SYMBOL**

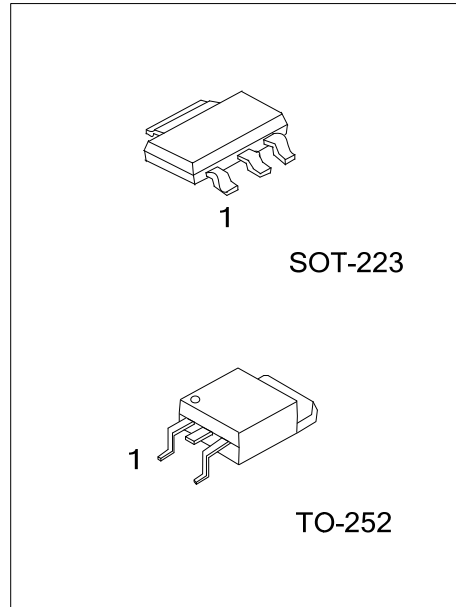
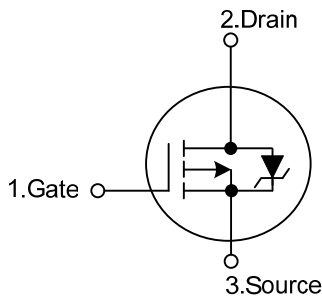

■ **ORDERING INFORMATION**

Ordering Number		Package	Pin Assignment			Packing
Lead Free	Halogen Free		1	2	3	
-	UT2955G-AA3-R	SOT-223	G	D	S	Tape Reel
UT2955L-TN3-R	UT2955G-TN3-R	TO-252	G	D	S	Tape Reel

Note: Pin Assignment: G: Gate D: Drain S: Source

<p>UT2955G-AA3-R</p> <p>(1)Packing Type (2)Package Type (3)Green Package</p>	<p>(1) R: Tape Reel (2) AA3: SOT-223, TN3: TO-252 (3) G: Halogen Free and Lead Free</p>
--	---

■ **MARKING**

SOT-223	TO-252

■ ABSOLUTE MAXIMUM RATINGS (T_a=25°C, unless otherwise specified)

PARAMETER	SYMBOL	RATINGS	UNIT
Drain-Source Voltage	V _{DSS}	-60	V
Gate-Source Voltage	V _{GSS}	±20	V
Continuous Drain Current	I _D	-1.7	A
Pulsed Drain Current	I _{DM}	-10.4	A
Single Pulsed Avalanche Energy (Note 3)	E _{AS}	225	mJ
Power Dissipation	SOT-223	1.0	W
	TO-252	1.13	W
Junction Temperature	T _J	+175	°C
Storage Temperature	T _{STG}	-55 ~ +175	°C

Note: 1. Absolute maximum ratings are those values beyond which the device could be permanently damaged.

Absolute maximum ratings are stress ratings only and functional device operation is not implied.

2. Pulse width limited by T_{J(MAX)}

3. V_{DD}=15V, V_G=10V, I_{PK}=6.7A, L=10mH, R_G=25Ω

■ THERMAL DATA

PARAMETER	SYMBOL	RATINGS	UNIT
Junction to Ambient	SOT-223	150	°C/W
	TO-252	110	°C/W
Junction to Case	SOT-223	14	°C/W
	TO-252	4.53	°C/W

■ ELECTRICAL CHARACTERISTICS (T_J=25°C, unless otherwise specified)

PARAMETER	SYMBOL	TEST CONDITIONS	MIN	TYP	MAX	UNIT
OFF CHARACTERISTICS						
Drain-Source Breakdown Voltage	BV _{DSS}	V _{GS} =0V, I _D =-250μA	-60			V
Drain-Source Leakage Current	I _{DSS}	V _{DS} =-60V, V _{GS} =0V			-1.0	μA
Gate-Source Leakage Current	I _{GSS}	V _{DS} =0V, V _{GS} =±20V			±100	nA
ON CHARACTERISTICS (Note)						
Gate Threshold Voltage	V _{GS(TH)}	V _{DS} =V _{GS} , I _D =-1.0mA	-2.0		-4.0	V
Static Drain-Source On-Resistance	R _{DS(ON)}	V _{GS} =-10V, I _D =-0.75A		145	170	mΩ
		V _{GS} =-10V, I _D =-1.5A		150	180	mΩ
		V _{GS} =-10V, I _D =-2.4A		154	185	mΩ
DYNAMIC PARAMETERS						
Input Capacitance	C _{ISS}	V _{DS} =-25V, V _{GS} =0V, f=1MHz		492		pF
Output Capacitance	C _{OSS}			165		pF
Reverse Transfer Capacitance	C _{RSS}			50		pF
SWITCHING PARAMETERS						
Total Gate Charge	Total	V _{DS} =30V, V _{GS} =10V, I _D =1.5A		14.3		nC
	Threshold		Q _G		1.2	
Gate Source Charge	Q _{GS}			2.3		nC
Gate Drain Charge	Q _{GD}			5.2		nC
Turn-ON Delay Time	t _{D(ON)}			11		ns
Turn-ON Rise Time	t _R		V _{GS} =10V, V _{DD} =25V, I _D =1.5A,		7.6	
Turn-OFF Delay Time	t _{D(OFF)}	R _G =9.1Ω, R _L =25Ω		65		ns
Turn-OFF Fall-Time	t _F			38		ns
SOURCE- DRAIN DIODE RATINGS AND CHARACTERISTICS						
Diode Forward Voltage	V _{SD}	I _S =1.5A, V _{GS} =0V		-1.10	-1.30	V
Body Diode Reverse Recovery Time	t _{RR}	V _{GS} =0V, dI _S /dI _t =100A/μs		36		ns
Body Diode Reverse Recovery Charge	Q _{RR}	I _S =1.5A		0.139		nC

Note: Pulse Test: pulse width ≤ 300 s, duty cycle ≤ 2%.

TYPICAL CHARACTERISTICS

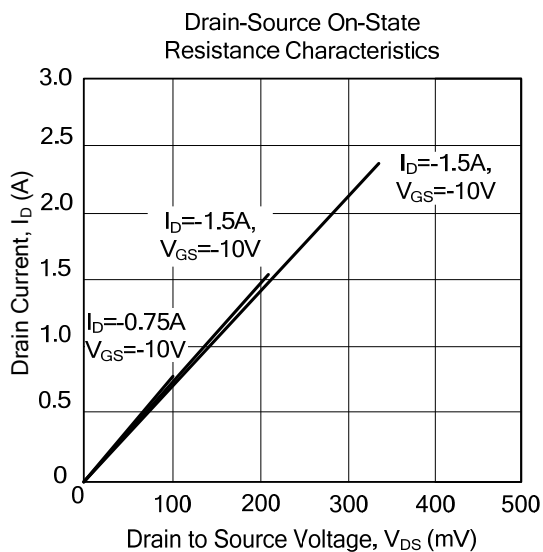
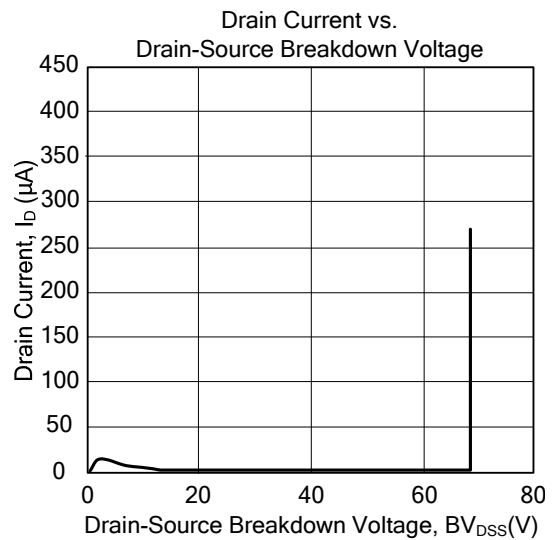
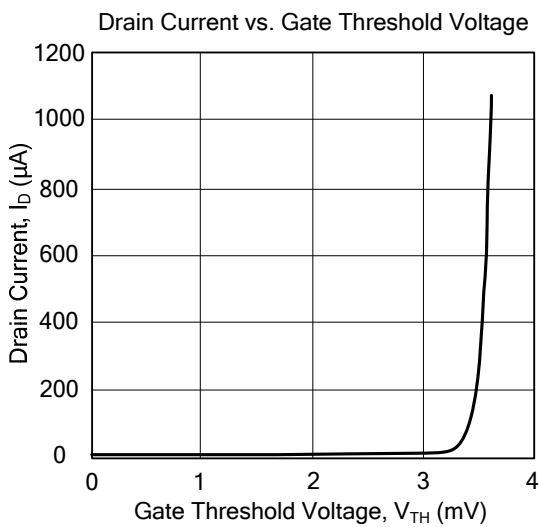
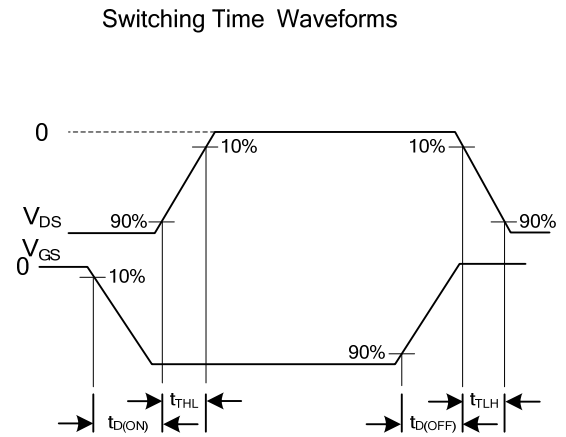
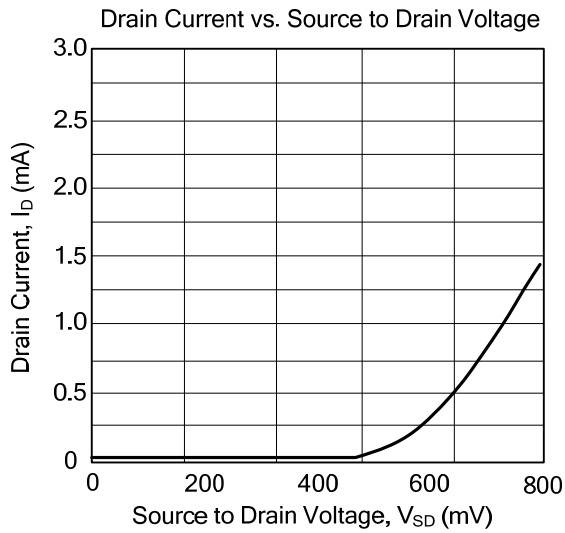

UTC assumes no responsibility for equipment failures that result from using products at values that exceed, even momentarily, rated values (such as maximum ratings, operating condition ranges, or other parameters) listed in products specifications of any and all UTC products described or contained herein. UTC products are not designed for use in life support appliances, devices or systems where malfunction of these products can be reasonably expected to result in personal injury. Reproduction in whole or in part is prohibited without the prior written consent of the copyright owner. The information presented in this document does not form part of any quotation or contract, is believed to be accurate and reliable and may be changed without notice.