

LITEON LITE-ON TECHNOLOGY CORPORATION

Property of LITE-ON Only



MSL: Level 1

APPROVAL SHEET

PRODUCT NAME	PHOTO-COUPLER IGBT GATE DRIVER
LITE-ON PART NO.	LTV-155E
CUSTOMER NAME	LG PDP
CUSTOMER PART NO.	EAV62035601
ISSUED DATE	22 October 2012

ISSUED DEPARTMENT: PRODUCT DEVELOPMENT (PD)

ISSUED BY: MARK LIN / WALLACE HSU (PD ENGINEER)

REVIEWED BY: DIO TZENG (PD PRINCIPAL ENGINEER)

APPROVED BY: KEVIN LIN (PD MANAGER)

林晉瀚 10/23

QUALITY ASSURANCE: JEFFREY SU (DQE MANAGER)

蘇宏元 10/23

LITE-ON TECHNOLOGY CORP.

90, Chien I Road, Chung Ho, Taipei Hsien, Taiwan, R.O.C

TEL: +886 2 2222 6181~8

FAX: +886 2 2221 1948

<http://www.liteon.com.tw>

Table of contents

- 1.0 Cover
- 2.0 Table of contents
- 3.0 Type document revision history
- 4.0 Datasheet & application notes & IR-Reflow profile
- 5.0 Package assembly specifications
- 6.0 Package inspection
 - 6.1 X-ray
 - 6.2 Top view & bottom view (Lead co-planarity spec)
 - 6.3 Chip dimensions
- 7.0 Product qualification report
(Reliability report, ESD, Latch up test)
- 8.0 Packing specification
- 9.0 QC flow
 - 9.1 Assembly QC flow
 - 9.2 FAB QC flow
 - 9.3 Abnormal Lot checking flow in final test
 - 9.4 Testing QC flow
- 10.0 Manufacturing control plan
- 11.0 Electrical characteristics
 - 11.1 Actual measured value of product electrical characters
 - 11.2 Actual measured value of important electrical characteristics
by operation temperature
 - 11.3 Actual measured value of important electrical characteristics by
voltage
- 12.0 Actual measurement value of each exterior part
- 13.0 Mean time to failure
- 14.0 Delaminating evaluation
- 15.0 CTQ actual measurement results in QC flow
- 16.0 SDS/SGS

LITEON | LITE-ON TECHNOLOGY CORPORATION

Property of LITE-ON Only

3.0 Type Document Revision History

Rev.	Date	Initiator	Description of Change
-	22 October 2012	Wallace Hsu	Original
A	4 December 2012	Wallace Hsu	To update safety approval, MSL and Pb free information
B	11 January 2013	Dio Tzeng	Cover page revised, Abnormal Lot management, Lead Co-planarity, Fab QC Flow, Delaminating Evaluation, REEL and internal and external packing material, MSDS / SGS

LITEON | LITE-ON TECHNOLOGY CORPORATION

Property of LITE-ON Only

4.0 Datasheet & Application Notes & IR-Reflow Profile

LTV-155E

Plasma Display Panel (PDP)
Industrial Inverter
MOS FET/ IGBT Gate Driver

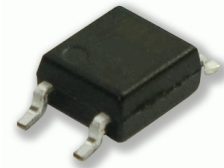

Description

The LTV-155E optocoupler is ideally suited for driving power IGBTs and MOSFETs used in plasma display panel. It contains an AlGaAs LED optically coupled to an integrated circuit with a power output stage. The Optocoupler operational parameters are guaranteed over the temperature range from $-40^{\circ}\text{C} \sim +100^{\circ}\text{C}$.

Functional Diagram

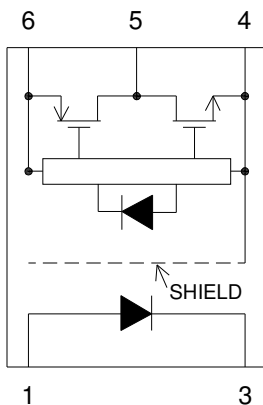

1. Anode
3. Cathode
4. GND
5. Vo (Output)
6. Vcc

Features

- 0.6A maximum peak output current
- 2.5mA maximum supply current (I_{CC})
- Wide operating range: 10 to 30 Volts (V_{CC})
- Rail to rail output voltage
- Guaranteed performance over temperature $-40^{\circ}\text{C} \sim +100^{\circ}\text{C}$.
- Threshold input current: $I_{FLH} = 7.5\text{mA}$ (max)
- Common mode transient immunity: $\pm 20\text{kV}/\mu\text{s}$ (min)
- Isolation voltage: $3750 V_{rms}$ (min)
- Fast switching speed, 200ns max propagation delay
- MSL 1 Level
- Safety approval

UL/ cUL 1577, Cert. No.E113898.

3750 Vrms/1 min

VDE DIN EN60747-5-5, Cert. No. 40015248

$V_{IORM} = 560 V_{peak}$

Application

- Plasma Display Panel .
- IGBT/MOSFET gate drive
- Industrial Inverter
- Induction heating
- Uninterruptible power supply (UPS)

Package Dimensions

SOP-5 Package (LTV-155E)

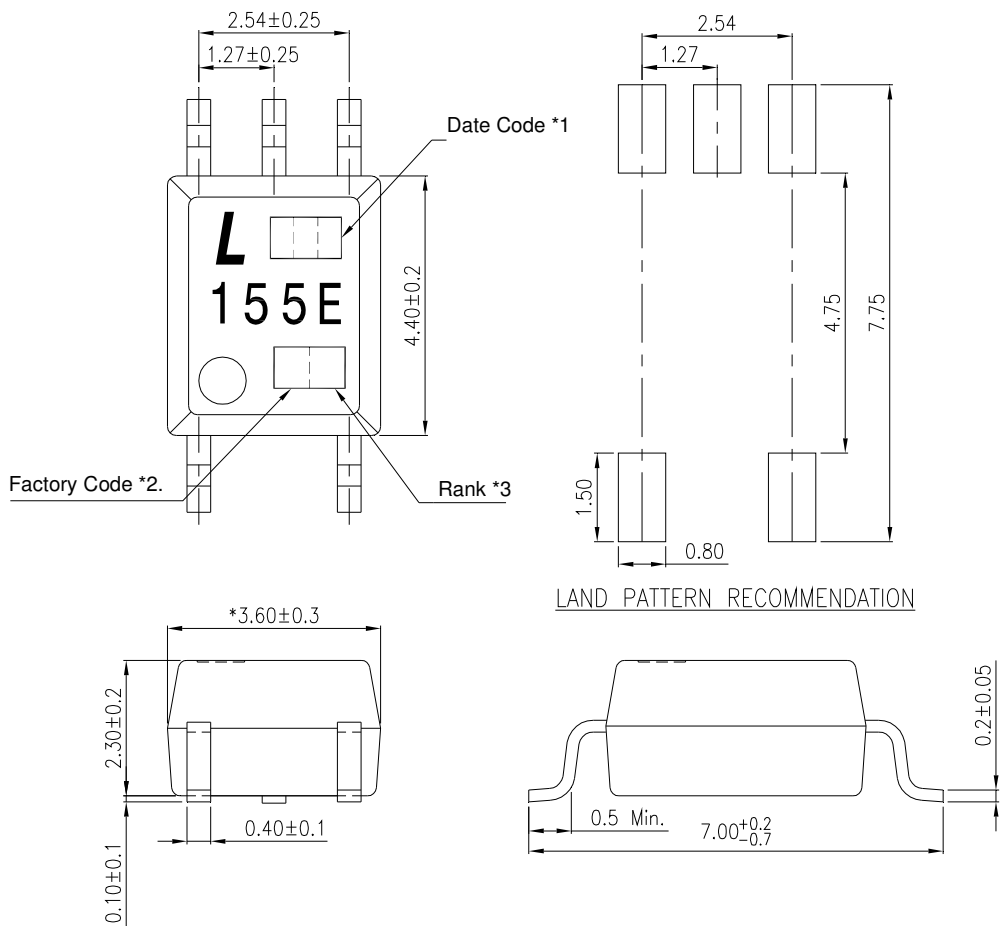

Notes :

1. All Dimensions in Millimeters
2. Mold flash per side is 0.15mm

Taping Dimensions

LTV-155E-TP1

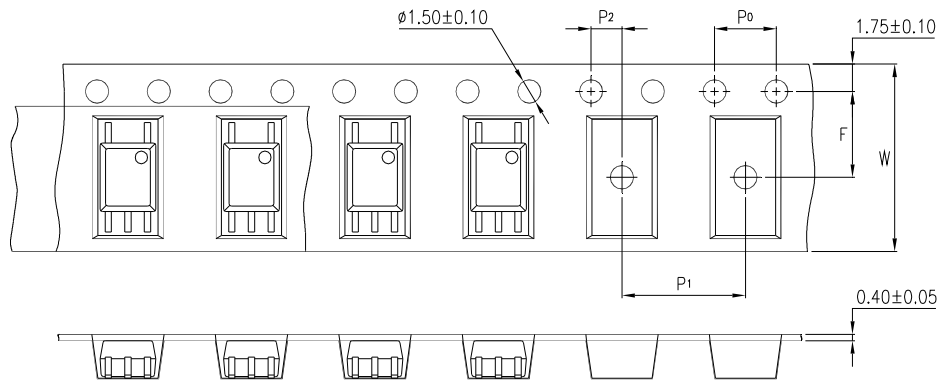

LTV-155E-TP

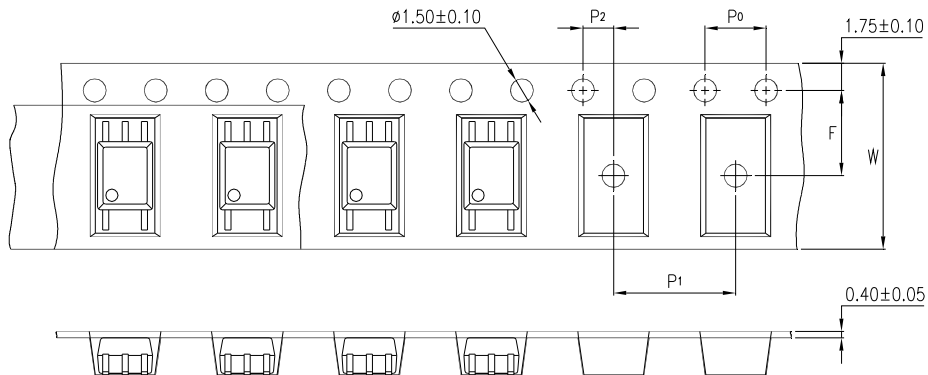

Description	Symbol	Dimensions in millimeters (inches)
Tape wide	W	12±0.3 (0.47)
Pitch of sprocket holes	P0	4±0.1 (0.15)
Distance of compartment	F	5.5±0.1 (0.217)
Distance of compartment to compartment	P2	2±0.1 (0.079)
Distance of compartment to sprocket hole	P1	8±0.1 (0.315)

Quantity Per Reel

Package Type	LTV-155E
Quantities(pcs)	3000

Parameter	Symbol	Min	Max	Units	Note
Storage Temperature	T_{ST}	-55	125	°C	
Operating Temperature	T_A	-40	100	°C	
Isolation Voltage	V_{ISO}	3750		V_{RMS}	
Supply Voltage	V_{CC}	0	35	V	
Lead Solder Temperature			260	°C	
Input					
Average Forward Input Current	$I_{F(AVG)}$		25	mA	
Reverse Input Voltage	V_R		5	V	
Peak Transient Input Current (<1 μs pulse width, 300 pps)	$I_{F(TRAN)}$		1	A	
Input Current (Rise/Fall time)	$t_{r(IN)} / t_{f(IN)}$		500	ns	
Input Power Dissipation ⁽²⁾	P_I		45	mW	
Output					
“High” Peak Output Current ⁽¹⁾	$I_{OH(PEAK)}$		0.6	A	
“Low” Peak Output Current ⁽¹⁾	$I_{OL(PEAK)}$		0.6	A	
Output Voltage	V_O		35	V	
Output Power Dissipation ⁽³⁾	P_O		250	mW	
Total Power Dissipation	P_T		295	mW	

1. At least a 0.1 μF or bigger bypass capacitor must be connected across pin 4 and pin 6.
Failure to provide the bypass may impair the switching property.
2. Derating Linearly above 70°C free-air temperature at a rate of 0.47 mW/°C
3. Derating Linearly above 70°C free-air temperature at a rate of 4.8mW/°C

Recommended Operating Conditions

Parameter	Symbol	Min	Max	Units
Operating Temperature	T_A	-40	100	°C
Supply Voltage	V_{CC}	10	30	V
Input Current (ON)	$I_{FL(ON)}$	10	15	mA
Input Voltage (OFF)	$V_{F(OFF)}$	-3.0	0.8	V

Electrical Specifications

Parameters	Test Condition	Symbol	Min	Typ	Max	Units	Fig	
Input								
Input Forward Voltage	$I_F=10\text{mA}$	V_F	1.2	1.37	1.8	V		
Temperature Coefficient Forward Voltage	$I_F = 10\text{mA}$	$\Delta V_F/\Delta T_A$	—	-1.237	—	mV/°C		
Input Reverse Breakdown Voltage	$I_R = 10\mu\text{A}$	BV_R	5	—	—	V		
Input Capacitance	$f = 1\text{MHz}, V_F = 0\text{V}$	C_{IN}	—	33	—	pF		
Threshold Input Current Low to High	$V_{CC}=15\text{V}, V_O > 5\text{V}$	I_{FLH}	—	2.6	7.5	mA	9	
Threshold Input Voltage High to Low	$V_{CC}=15\text{V}, V_O < 5\text{V}$	V_{FHL}	0.8	—	—	V		
Output								
High level output current ⁽¹⁾	$V_{CC}=15\text{V}, I_F=10\text{mA},$	$V_{6-5}=2\text{V}$	I_{OPH1}	—	-0.5	-0.2	A	3, 5, 15
		$V_{6-5}=10\text{V}$	I_{OPH2}	—	—	-0.4		
Low level output current ⁽¹⁾	$V_{CC}=15\text{V}, I_F=0\text{mA},$	$V_{5-4}=2\text{V}$	I_{OPL1}	0.2	0.5	—	A	4, 6, 16
		$V_{5-4}=10\text{V}$	I_{OPL2}	0.4	—	—		
High level output voltage	$V_{CC}=10\text{V}, I_F = 10\text{mA}, I_O = -100\text{mA}$	V_{OH}	9	9.55	—	V	1, 17	
Low level output voltage	$V_{CC}=10\text{V}, I_F = 0\text{mA}, I_O = 100\text{mA}$	V_{OL}	—	0.3	1		2, 18	
High Level Supply Current	$V_{CC}=10\text{ to }20\text{V}, I_F = 10\text{mA}, V_O=\text{Open}$	I_{CCH}	—	1.5	3.0	mA	7, 8, 19	
Low Level Supply Current	$V_{CC}=10\text{ to }20\text{V}, I_F = 0\text{mA}, V_O=\text{Open}$	I_{CCL}	—	1.5	3.0		7, 8, 20	

All Typical values at $T_A = 25^\circ\text{C}$, unless otherwise specified.

Switching Specifications

Parameter		Test Condition		Symbol	Min	Typ	Max	Units	Fig
Propagation Delay Time	L→H	V _{CC} =20V I _F = 10mA R _g = 30 Ω, C _g = 1 nF, f= 250 kHz, Duty= 50%	T _a =25 °C I _F =0→10mA	T _{PLH}	—	115	170	ns	10, 11, 12, 13, 14, 21
	H→L		T _a =25 °C I _F =10→0mA	T _{PHL}	—	110	170		
	L→H		I _F =0→10mA	T _{PLH}	50	115	200		
	H→L		I _F =10→0mA	T _{PHL}	50	110	200		
Switching Time Dispersion			I _F =0→10mA	t _{PHL} - t _{PLH}	—	5	50		—
Output Rise Time (90 to 10%)			I _F =0→10mA	T _r	—	30	—		21
Output Fall Time (90 to 10%)			I _F =10→0mA	T _f	—	15	—		
Common Mode Transient Immunity at HIGH Level Output		I _F =10mA, V _{CM} =1000V, T _A =25 °C, V _{CC} =20V		CM _H	-20	—	—	kV/μs	22
Common Mode Transient Immunity at LOW Level Output		V _F =0V, V _{CM} =1000V, T _A =25 °C, V _{CC} =20V		CM _L	20	—	—		

Specified over recommended operating conditions (T_A = -40 to 100 °C, I_F= 10 to 15mA, V_F(OFF) = -3.0 to 0.8 V, V_{CC} = 10 to 30 V) unless otherwise specified.

Isolation Characteristics

Parameter	Test Condition	Symbol	Min	Typ	Max	Units	Note
Withstand Insulation Test Voltage	$RH \leq 40-60\%$, $t = 1\text{min}$, $T_A = 25^\circ\text{C}$	V_{ISO}	3750	—	—	V	2, 3
Input-Output Resistance	$V_{I-O} = 500\text{V DC}$	R_{I-O}	—	10^{12}	—	Ω	2
Input-Output Capacitance	$f = 1\text{MHz}$, $T_A = 25^\circ\text{C}$	C_{I-O}	—	0.92	—	pF	

Specified over recommended operating conditions ($T_A = -40$ to 100°C , $I_F = 10$ to 15mA , $V_F(\text{OFF}) = -3.0$ to 0.8 V , $V_{CC} = 10$ to 30 V) unless otherwise specified.

Typical Performance Curves

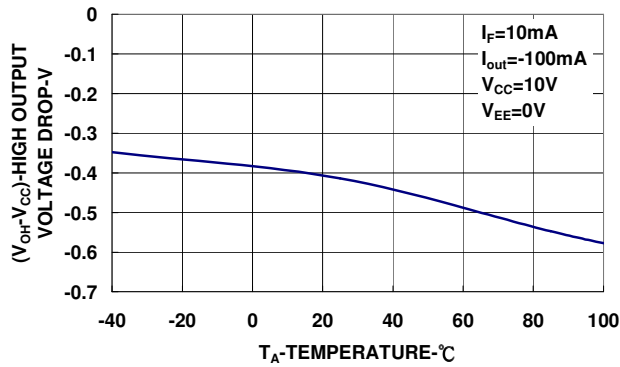

Figure 1: Output High Voltage drop vs. Temperature

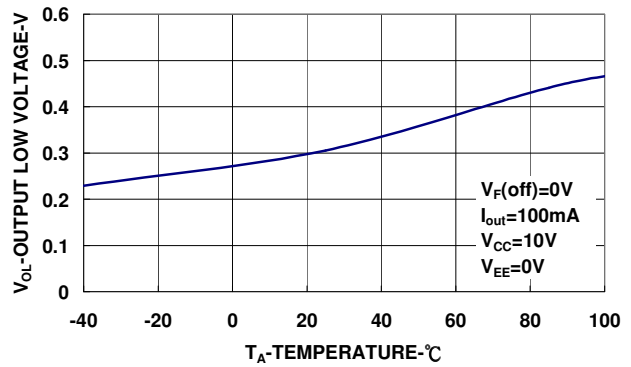

Figure 2: Output Low Voltage vs. Temperature

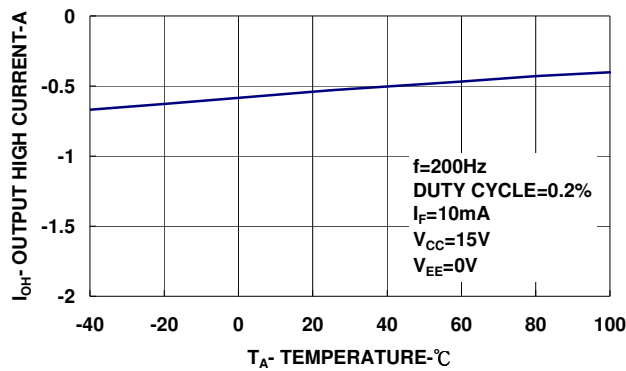

Figure 3: Output High Current vs. Temperature

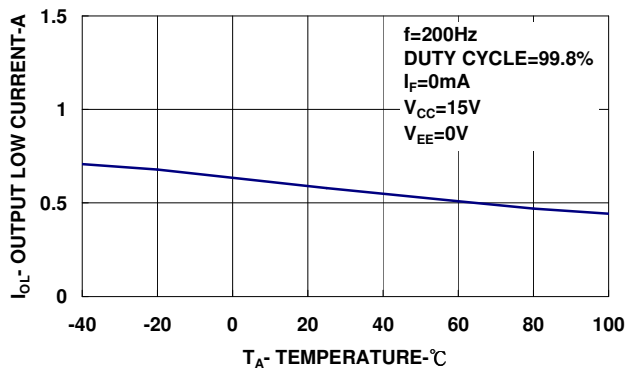

Figure 4: Output Low Current vs. Temperature

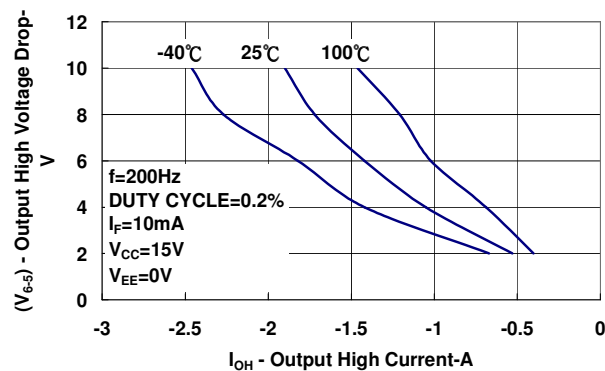

Figure 5 : Output High Voltage drop vs. High Current

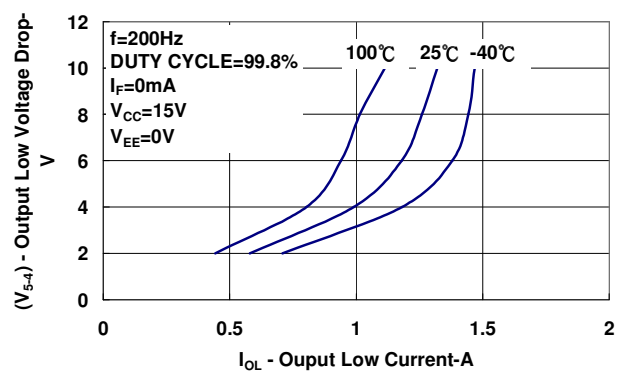

Figure 6 : Output High Voltage drop vs. Low Current

Typical Performance Curves

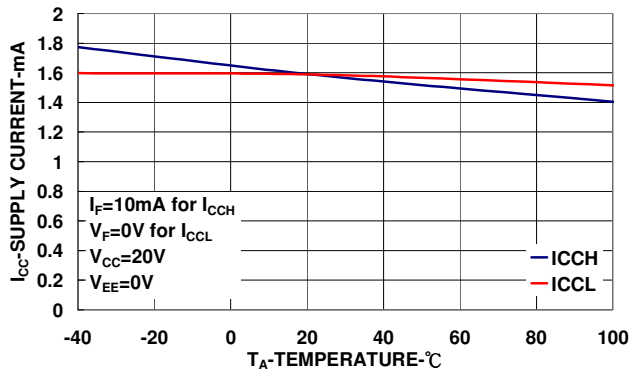

Figure 7 : Supply Current vs. Temperature

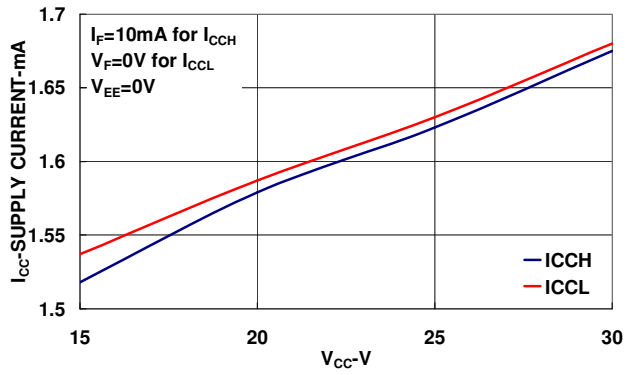

Figure 8 : Supply Current vs. Supply Voltage

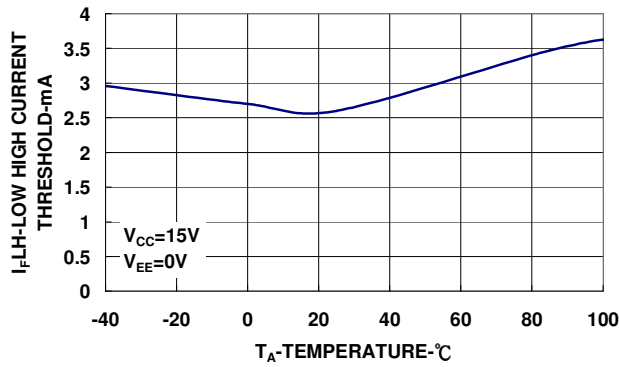

Figure 9 : Low to High Threshold Current vs. Temperature

Property of LITE-ON Only

Typical Performance Curves

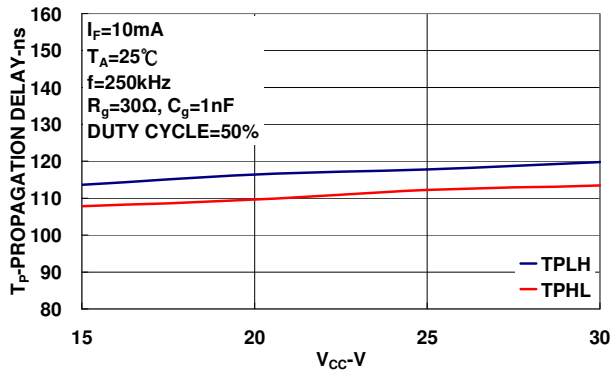

Figure 10 : Propagation vs. Supply Voltage

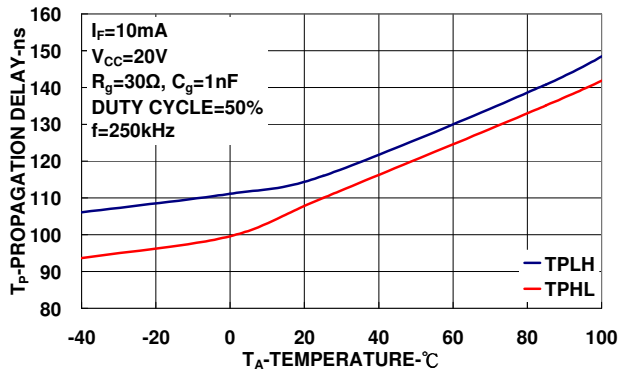

Figure 11 : Propagation vs. Temperature

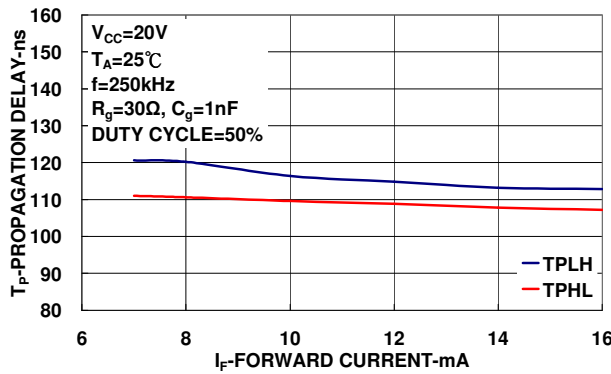

Figure 12 : Propagation vs. Forward Current

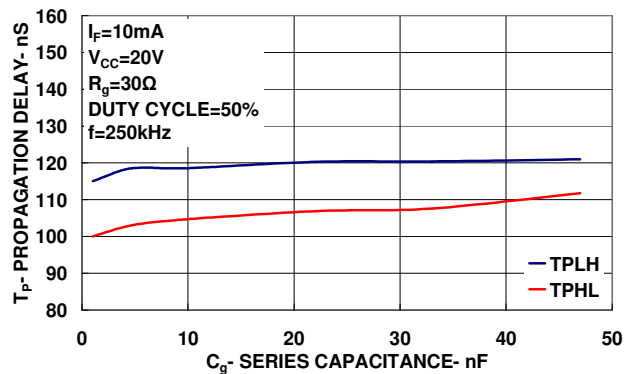

Figure 13 : Propagation vs. Load Capacitance

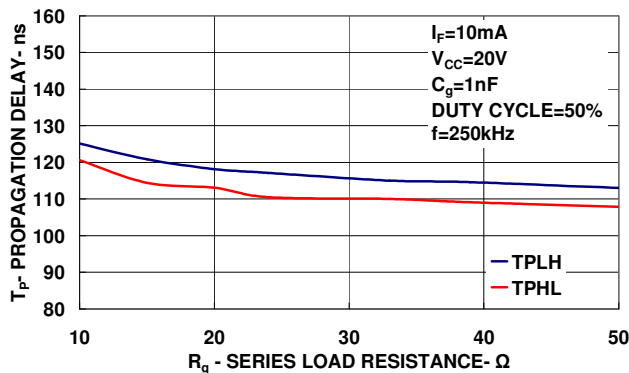

Figure 14 : Propagation vs. Load Resistance

Test Circuit

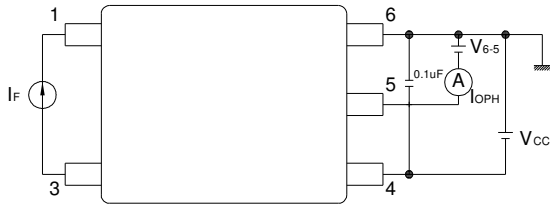

Figure 15 : IOPH test circuit

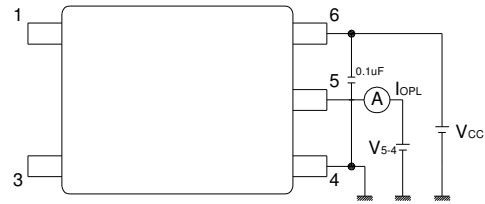

Figure 16 : IOPL test circuit

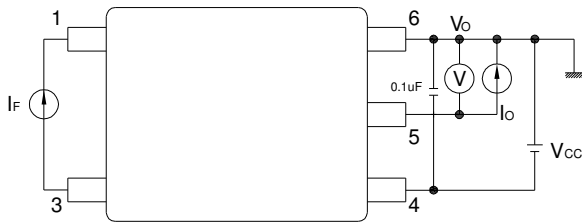

Figure 17 : VOH test circuit

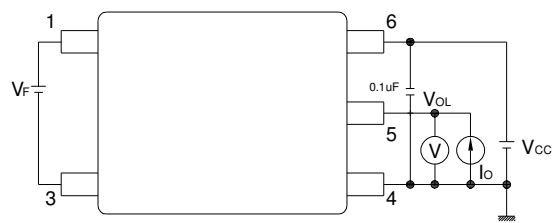

Figure 18 : VOL test circuit

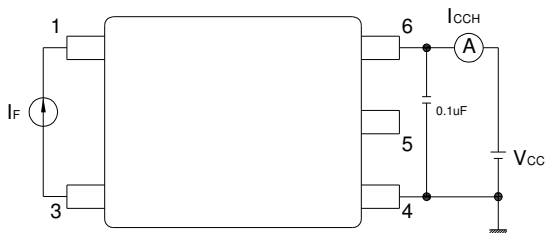

Figure 19 : ICCH test circuit

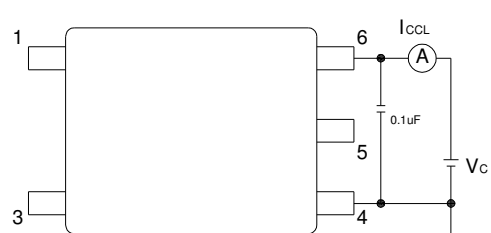

Figure 20 : ICCL test circuit

Test Circuit

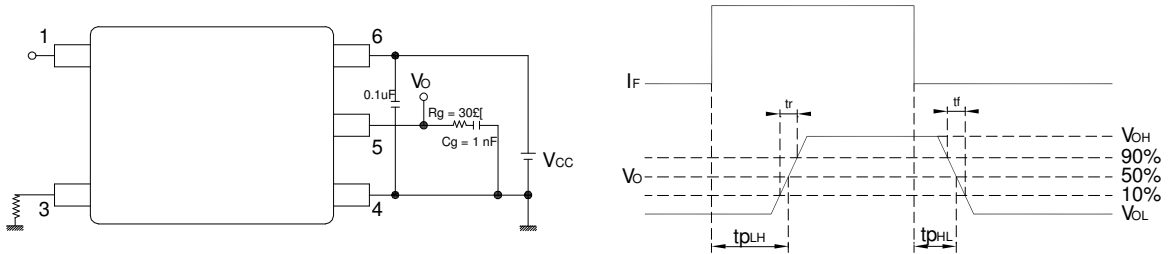

Figure 21 : tp_{LH} , tp_{HL} , tr , tf , $|tp_{HL}-tp_{LH}|$ test circuit

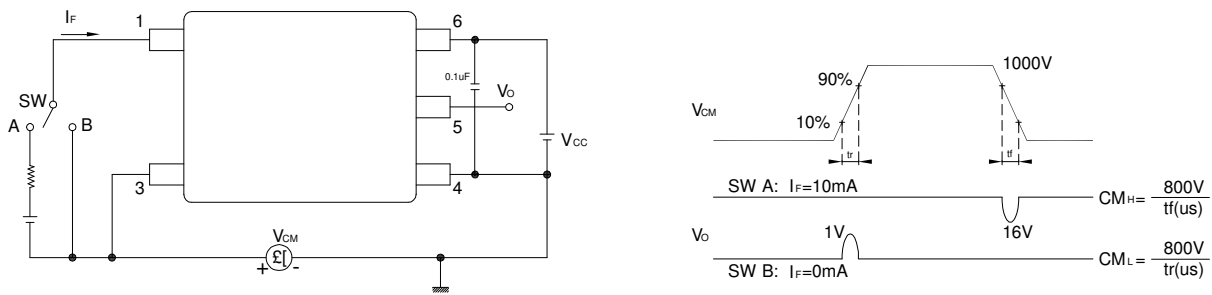

Figure 22 : CMR test circuit with split resistors network and waveforms

Temperature Profile of Soldering Reflow

(1) IR Reflow soldering (JEDEC-STD-020C compliant)

One time soldering reflow is recommended within the condition of temperature and time profile shown below.

Profile item	Conditions
Preheat - Temperature Min (T_{Smin}) - Temperature Max (T_{Smax}) - Time (min to max) (ts)	150°C 200°C 90±30 sec
Soldering zone - Temperature (T_L) - Time (t_L)	217°C 60 sec
Peak Temperature (T_P)	260°C
Ramp-up rate	3°C / sec max.
Ramp-down rate	3~6°C / sec

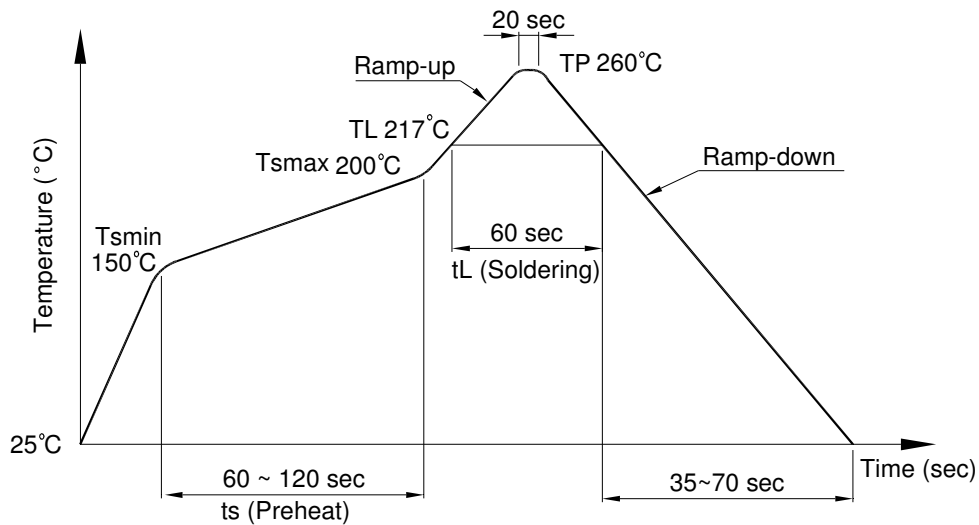

Temperature Profile of Soldering Reflow

(2) Wave soldering (JEDEC22A111 compliant)

One time soldering is recommended within the condition of temperature.

Temperature: $260 \pm 0 / -5^{\circ}\text{C}$

Time: 10 sec.

Preheat temperature: 25 to 140°C

Preheat time: 30 to 80 sec.

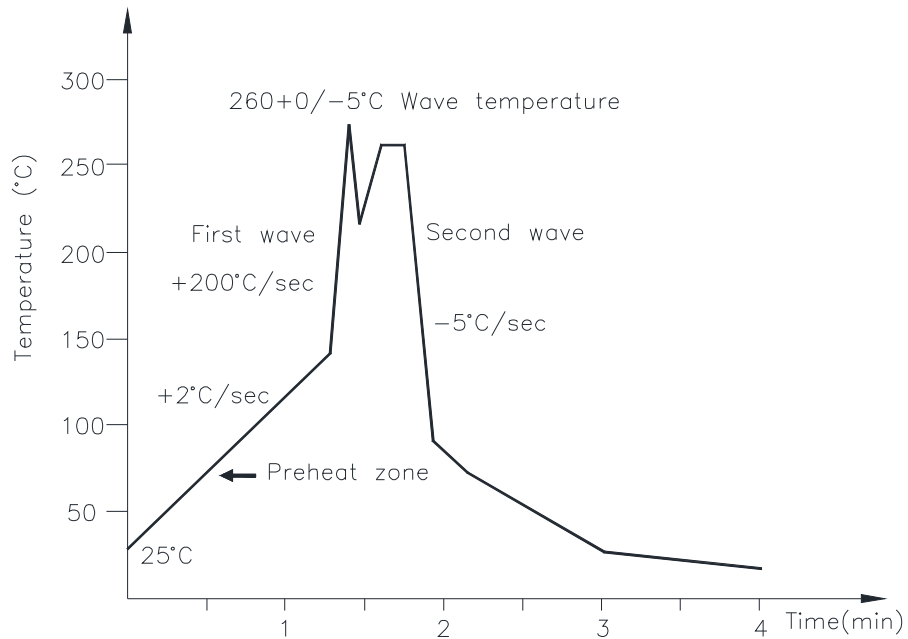

(3) Hand soldering by soldering iron

Allow single lead soldering in every single process. One time soldering is recommended.

Temperature: $380 \pm 0 / -5^{\circ}\text{C}$

Time: 3 sec max.

Application Information

Recommended Application Circuit

The recommended application circuit shown in Figure 23 which is a typical gate drive application is using the LTV-155E. The following describes about driving IGBT. However, it is also suitable to MOSFET. Designer will need to tune the V_{CC} supply voltage, depend on the IGBT or MOSFET gate threshold requirements (Recommended $V_{CC} = 15V$ for IGBT and $12V$ for MOSFET).

The supply bypass capacitors ($0.1 \mu F$) provide the large transient current necessary during a switching transition. Since the transient nature of the charging currents, a low current power supply ($3.0mA$) power supply will be enough to power the device. The split resistors (in the ratio of 1.5:1) across the LED will provide a high CMR response by providing a balanced resistance network across the LED.

The gate resistor R_g serves to limit gate charge current and controls the IGBT collector voltage rise and fall times.

In PC board design, care should be taken to avoid routing the IGBT collector or emitter traces close to the LTV-155E input as this can result in unwanted coupling of transient signals into LTV-155E and degrade performance.

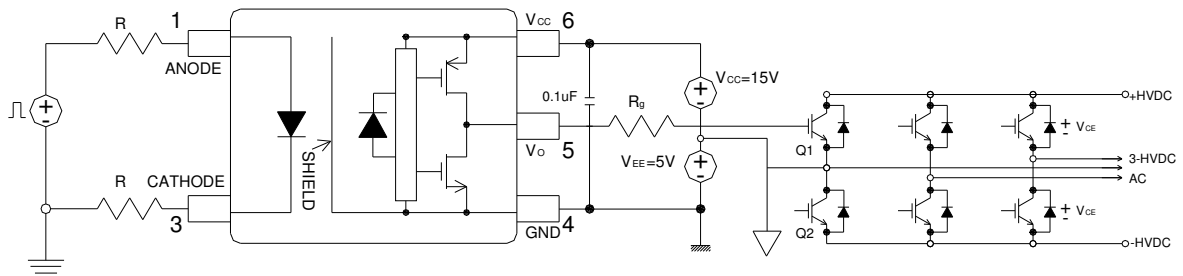

Figure 23 : Recommended application circuit with split LED drive

Application Information

Rail-to-Rail Output

LTV-155E uses a power PMOS to deliver the large current and pull it to V_{CC} to achieve rail-to-rail output voltage as shown in Figure 24. This ensures that the IGBT's gate voltage is driven to the optimum intended level with no power loss across IGBT even when an unstable power supply is used.

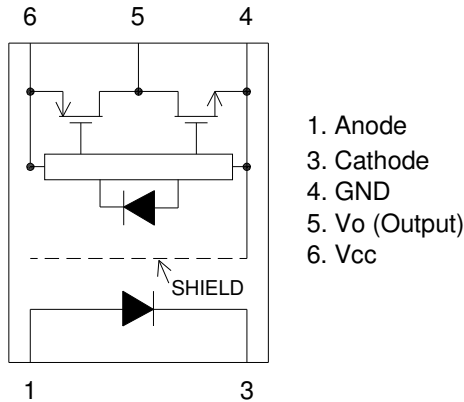

Figure 24 : LTV-155E with PMOS and NMOS output stage for rail-to-rail output voltage

LED Drive Considerations for High CMR Performance

CMR with the LED On (CMR_H)

A high CMR LED drive circuit must keep the LED on (short A) during common mod transients. This is achieved by overdriving the LED current beyond the input threshold so that it is not pulled below the threshold during a transient. A minimum LED current of 10mA provides adequate margin over the maximum I_{FLH} of 7.5mA to achieve 20 kV/ μ s CMR

CMR with the LED off (CMR_L)

A high CMR LED drive circuit must keep the LED off (short B, $V_F \leq V_{F(OFF)}$) during common mode transients. For example during a $-dV_{cm}/dt$ transient in Figure 25, the current flowing through CLEDP, the LED will remain off and no common mode failure will occur. Figure 25 is like the recommended application circuit (Figure 23), dose achieve ultra high CMR performance by shunting the LED in the off state.

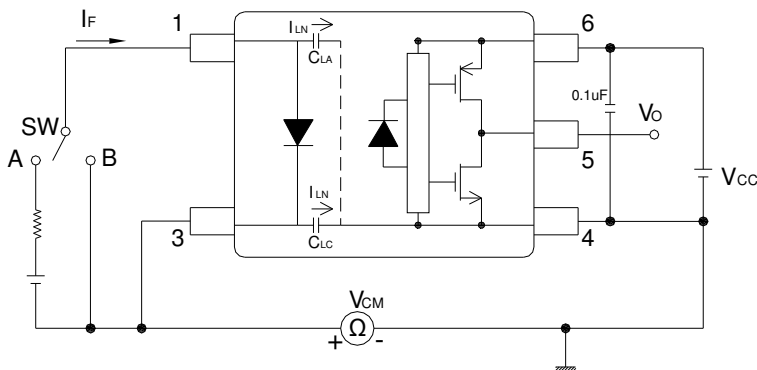

Figure 25 : Recommended high-CMR drive circuit for the LTV-155E

Application Information

Dead time and Propagation Delay Specification

The LTV-155E includes a Propagation Delay Difference (PDD) specification intended to help designers minimize “dead time” in their power inverter designs. Dead time is the time period during which both the high and low side power transistors (Q1 and Q2 in Figure 23) are off. Any overlap in Q1 and Q2 conduction will result in large currents flowing through the power devices between the high and low voltage motor rails.

To minimize dead time in a given design, the turn on of LED2 should be delayed (relative to the turn off of LED1) so that under worst-case conditions, transistor Q1 has just turned off when transistor Q2 turns on, as shown in Figure 26. The amount of delay necessary to achieve this condition is equal to the maximum value of the propagation delay difference specification, PDD_{MAX}, which is specified to be 100 ns over the operating temperature range of 40 °C to 100 °C.

Delaying the LED signal by the maximum propagation delay difference ensures that the minimum dead time is zero, but it does not tell a designer what the maximum dead time will be. The maximum dead time is equivalent to the difference between the maximum and minimum propagation delay difference specifications as shown in Figure 27. The maximum dead time for the LTV-155E is 200 ns (= 100 ns - (-100 ns)) over an operating temperature range of -40 °C to 100C.

Note that the propagation delays used to calculate PDD and dead time are taken at equal temperatures and test conditions since the Photocouplers under consideration are typically mounted in close proximity to each other and are switching identical IGBTs.

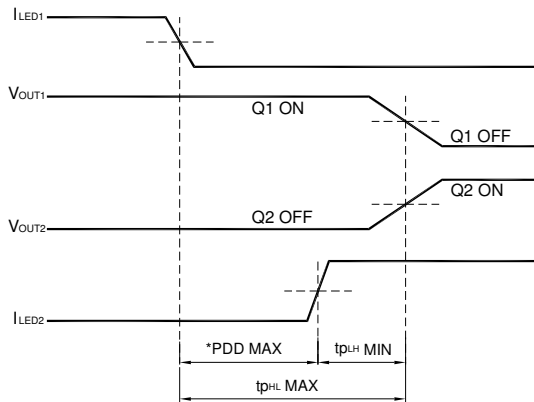

Figure 26 : Minimum LED skew for zero dead time

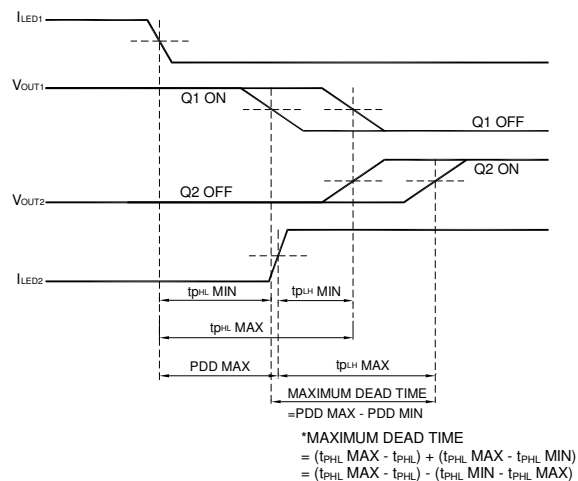

Figure 27 : Waveforms for dead time

*PDD = PROPAGATION DELAY DIFFERENCE

NOTE : FOR PDD CALCULATIONS THE PROPAGATION DELAYS ARE TAKEN AT THE SAME TEMPERATURE AND TEST CONDITION.

Notice

- 1) Maximum pulse width = 10us, maximum duty cycle = 0.2%.
- 2) Device is considered a two terminal device: pins 1, 3 are shorted together and pins 4, 5, 6 are shorted together.
- 3) According to UL1577, each optocoupler is tested by applying an insulation test voltage ≥ 3750 Vrms for 1 second (leakage detection current limit, $I_{L-O} \leq 10$ uA).
- 4) Common mode transient immunity in high stage is the maximum tolerable negative dV_{cm}/dt on the trailing edge of the common mode impulse signal, V_{cm} , to assure that the output will remain high.
- 5) Common mode transient immunity in low stage is the maximum tolerable positive dV_{cm}/dt on the leading edge of the common mode impulse signal, V_{cm} , to assure that the output will remain low.

5.0 Package Assembly Specifications

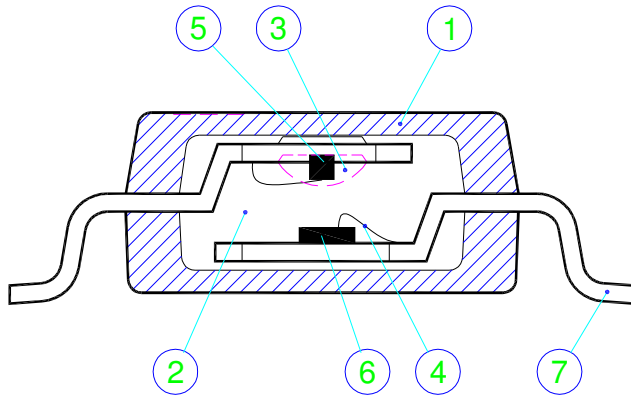

1. Black epoxy resin
2. Semitransparent epoxy resin
3. Transparent silicone resin
4. Gold wire
5. Emitter
6. Detector
7. Lead frame

LITEON LITE-ON TECHNOLOGY CORPORATION

Property of LITE-ON Only

6.0 Package inspection

6.1 X-ray

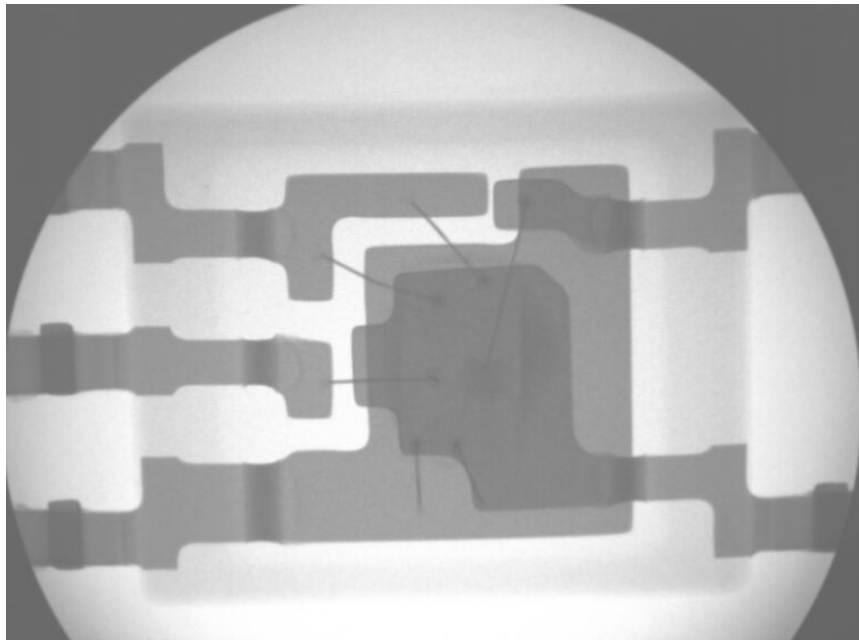

6.2 Top view & Bottom view & Side view

Top view

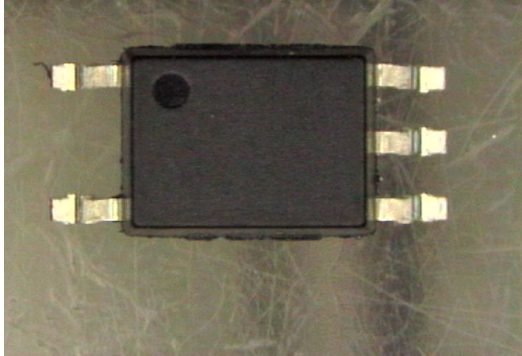

Side view

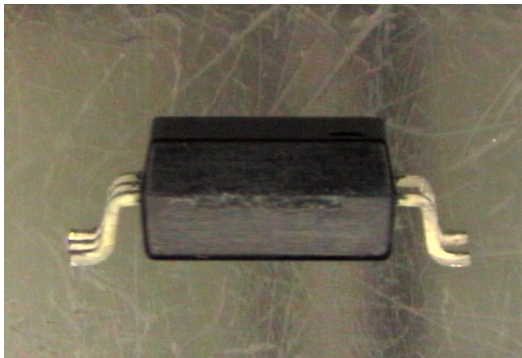

Bottom view

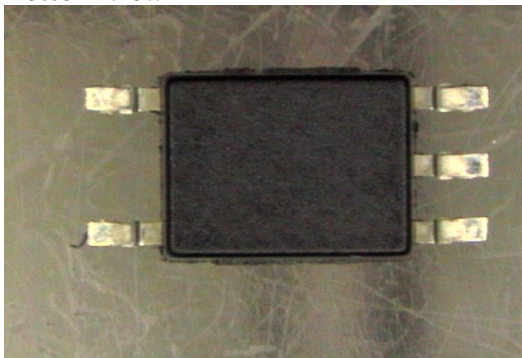

*. Lead Co-planarity: 0.10 mm Max. (Reference JEDEC-MO-155)

LITEON LITE-ON TECHNOLOGY CORPORATION

Property of LITE-ON Only

6.3 Chip dimensions (Top view by real measured)

Emitter

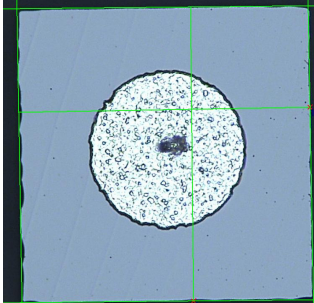

No.	Measure	Result
1	Parallel	220.31 um
2	Parallel	220.84 um

Detector



No.	Measure	Result
1	Parallel	1472.23 um
2	Parallel	859.68 um

LITEON | LITE-ON TECHNOLOGY CORPORATION

Property of LITE-ON Only

7.0 Product Qualification Report (Reliability Report, ESD)

Property of LITE-ON Only

Reliability Test Report

Lite-on electronics (Thailand) Co., Ltd

Qualification

Package: MFP / Potocouplers
Part Number: LTV-155E
Products Type: High Speed IGBT/MOSFET Gate Driver.
Test Purpose: New design IGBT of MFP qualification.
Test Period: 23-April ~ 25-June-2012
Page: 1/3

Test Item as require:

Test title	Sample size	Test Condition	Result	Remark
Pre-conditioning test	315	125°C=24Hrs, 85°C 85%RH=168Hrs and IR Reflow 260°C Peak=3Cycles	315	
Temp Cycling Test	45	Ta= -40~125°C, Dwell time = 15 min per Zone, 1000Cycles	45	
High temp High Humidity Bias test	45	Ta=85°C, 85%RH, IF=16mA, Vin= 5V, IO=20mA, Vcc= 30V, 1000Hrs.	45	
High Temp Operation Life	45	Ta=110°C, IF=16mA, Vin= 5V, IO=20mA, Vcc= 30V, 1000Hrs.	45	
High Temp Reverse Bias Test	45	Ta=110°C, VCE = 30V, 1000Hrs.	45	
Autoclave	45	Temp=121°C, 100%RH and 15Psi, 96Hrs.	45	
High temp storage	45	Temp= 150°C, 1000Hrs.	45	
Low temp storage	45	Temp= -55°C, 1000Hrs.	45	
Non-Preconditioning test				
Autoclave	20	Temp=121°C, 100%RH and 15Psi, 96Hrs.	20	

Spec limit of product.

Parameter	Measurement condition	Symbol	Min	Max	Unit
Input Forward Voltage	IF= 10 mA	VF	-	1.8	V
Reverse Leakage Current	VR= 5V	IR	-	10	uA
High Level Output Current	Vo=(VCC-4V)	IOH	0.2	-	A
Low Level Output Current	Vo=(VEE+2V)	IOL	0.2	-	A
High Level Output Voltage	Io= -100mA, IF= 10mA	VOH	VCC-1	-	V
Low Level Output Voltage	Io=100mA	VOL	-	VEE+1	V
High Level Supply Current	IF=10 to 16 mA	ICCH	-	3.5	mA
Low Level Supply Current	IF=-3 to 0.8 V	ICCL	-	3.5	mA
Threshold Input Current Low to High	IO=0mA, Vo>5V	IFLH	-	7.5	mA
Threshold Input Voltage High to Low	IO=0mA, Vo<5V	VFHL	0.8	-	V

Reliability criteria:

1. Reading value for each step test not over 50% Delta for VF, VOH, VOL, ICCH, ICCL parameter.
2. Reading value for each step test go/no go for IOH, IOL, VFHL and IFLH parameter.
3. Short and open is criteria of Temp cycling and Autoclave test item.

Final Conclusion of reliability test:

All samples unit under test are conforming to reliability criteria.

Lab's comment:

- The value on each test item (next page) is average value from all units under test except defect sample.
- Effect this the results relate only to the items tested
- The report shall not be reproduced except in full, without the written approval of the laboratory.

Test Operator Lumpley

Report Checker Amz

Approve Sahul

LITEON LITE-ON TECHNOLOGY CORPORATION

Property of LITE-ON Only

Test summary table. (Average value for all units under test)

Temperature Cycling (TCML) (Pre-Conditioning)											
Parameter	Unit	0 Cyc	100 Cyc	*Decay	200 Cyc	*Decay	500 Cyc	*Decay	1000 Cyc	*Decay	Remark
VF	V	1.389	1.388	-0.055	1.393	0.280	1.388	-0.100	1.390	0.229	
IR	μA	0.079	0.083	0.004	0.084	0.005	0.050	-0.029	0.056	-0.023	
IOH1	A	-1.147	-1.146	0.001	-1.156	-0.009	-1.129	0.018	-1.097	0.050	
IOH2	A	-1.899	-1.900	-0.001	-1.912	-0.013	-1.887	0.013	-1.874	0.021	
IOL1	A	0.694	0.688	-0.006	0.710	0.016	0.695	0.001	0.664	-0.030	
IOL2	A	1.360	1.354	-0.005	1.380	0.020	1.372	0.013	1.373	0.013	
VOH	V	9.683	9.723	0.415	9.730	0.482	9.718	0.358	9.717	0.347	
VOL	V	0.258	0.266	3.242	0.263	2.016	0.271	4.920	0.280	8.654	
ICCH	mA	1.731	1.734	0.205	1.733	0.129	1.734	0.218	1.734	0.107	
ICCL	mA	1.712	1.716	0.269	1.708	-0.222	1.717	0.296	1.716	0.054	
IFLH	mA	2.536	2.554	0.018	2.539	0.003	2.209	-0.326	2.094	-0.494	
VFHL	mA	1.055	1.155	0.100	1.171	0.116	1.176	0.121	1.160	0.108	

*Decay of VF, VOH, VOL, ICCH and ICCL are "%Delta" / *Decay of IR, IOH, IOL, VFLH and IFLH are "Delta"

High Temp High Humidity Bias (THBT) (Pre-Conditioning)									
Parameter	Unit	0 Hr	168 Hrs	*Decay	500 Hrs	*Decay	1000 Hrs	*Decay	Remark
VF	V	1.387	1.391	0.293	1.384	-0.193	1.386	-0.051	
IR	μA	0.089	0.083	-0.006	0.050	-0.039	0.056	-0.033	
IOH1	A	-1.150	-1.142	0.009	-1.107	0.043	-1.096	0.052	
IOH2	A	-1.899	-1.895	0.004	-1.860	0.039	-1.857	0.040	
IOL1	A	0.694	0.708	0.014	0.694	0.000	0.676	-0.019	
IOL2	A	1.357	1.382	0.025	1.371	0.013	1.371	0.014	
VOH	V	9.685	9.725	0.418	9.714	0.304	9.715	0.314	
VOL	V	0.257	0.265	2.786	0.272	5.544	0.277	7.479	
ICCH	mA	1.723	1.718	-0.226	1.717	-0.294	1.718	-0.382	
ICCL	mA	1.704	1.696	-0.447	1.709	0.303	1.709	0.226	
IFLH	mA	2.611	2.640	0.029	2.586	-0.025	1.783	-0.787	
VFHL	mA	1.044	1.167	0.123	1.173	0.129	1.112	0.071	

*Decay of VF, VOH, VOL, ICCH and ICCL are "%Delta" / *Decay of IR, IOH, IOL, VFLH and IFLH are "Delta"

High Temp Operation Life (HTOL) (Pre-Conditioning)									
Parameter	Unit	0 Hr	168 Hrs	*Decay	500 Hrs	*Decay	1000 Hrs	*Decay	Remark
VF	V	1.391	1.392	0.082	1.386	-0.408	1.387	-0.223	
IR	μA	0.088	0.083	-0.005	0.049	-0.040	0.056	-0.033	
IOH1	A	-1.159	-1.149	0.010	-1.109	0.050	-1.105	0.054	
IOH2	A	-1.912	-1.901	0.011	-1.861	0.051	-1.864	0.047	
IOL1	A	0.700	0.712	0.013	0.687	-0.013	0.681	-0.019	
IOL2	A	1.364	1.383	0.019	1.369	0.005	1.371	0.008	
VOH	V	9.687	9.728	0.416	9.714	0.279	9.717	0.302	
VOL	V	0.255	0.262	2.679	0.274	7.227	0.275	7.905	
ICCH	mA	1.732	1.732	-0.046	1.731	-0.075	1.724	-0.137	
ICCL	mA	1.709	1.707	-0.066	1.719	0.639	1.712	0.415	
IFLH	mA	2.495	2.516	0.021	2.020	-0.475	1.647	-0.871	
VFHL	mA	1.047	1.171	0.124	1.176	0.129	1.123	0.075	

*Decay of VF, VOH, VOL, ICCH and ICCL are "%Delta" / *Decay of IR, IOH, IOL, VFLH and IFLH are "Delta"

LITEON LITE-ON TECHNOLOGY CORPORATION

Property of LITE-ON Only

High Temp Reverse Bias (HTRB) (Pre-Conditioning)									
Parameter	Unit	0 Hr	168 Hrs	*Decay	500 Hrs	*Decay	1000 Hrs	*Decay	Remark
VF	V	1.390	1.391	0.091	1.384	-0.438	1.386	-0.308	
IR	μA	0.087	0.083	-0.004	0.050	-0.037	0.055	-0.032	
IOH1	A	-1.158	-1.152	0.006	-1.120	0.038	-1.123	0.034	
IOH2	A	-1.909	-1.903	0.006	-1.870	0.040	-1.873	0.033	
IOL1	A	0.700	0.714	0.014	0.693	-0.006	0.695	-0.005	
IOL2	A	1.365	1.383	0.018	1.369	0.004	1.373	0.008	
VOH	V	9.687	9.729	0.432	9.718	0.314	9.720	0.346	
VOL	V	0.255	0.261	2.428	0.272	6.420	0.271	6.269	
ICCH	mA	1.740	1.740	-0.027	1.742	0.096	1.740	0.065	
ICCL	mA	1.717	1.714	-0.224	1.726	0.481	1.724	0.284	
IFLH	mA	2.501	2.503	0.001	2.109	-0.392	1.597	-0.883	
VFHL	mA	1.050	1.167	0.117	1.171	0.121	1.111	0.062	

*Decay of VF, VOH, VOL, ICCH and ICCL are "%Delta" / *Decay of IR, IOH, IOL, VFLH and IFLH are "Delta"

Autoclave (AC) (Pre-Conditioning)					
Parameter	Unit	0 Hr	96 Hrs	*Decay	Remark
VF	V	1.391	1.392	0.075	
IR	μA	0.088	0.084	-0.004	
IOH1	A	-1.158	-1.124	0.035	
IOH2	A	-1.913	-1.876	0.037	
IOL1	A	0.701	0.707	0.006	
IOL2	A	1.367	1.383	0.016	
VOH	V	9.687	9.720	0.342	
VOL	V	0.255	0.265	3.821	
ICCH	mA	1.735	1.746	0.630	
ICCL	mA	1.713	1.714	0.022	
IFLH	mA	2.582	2.424	-0.158	
VFHL	mA	1.043	1.170	0.127	

*Decay of VF, VOH, VOL, ICCH and ICCL are "%Delta" / *Decay of IR, IOH, IOL, VFLH and IFLH are "Delta"

High Temp Storage Life (HTSL) (Pre-Conditioning)									
Parameter	Unit	0 Hr	168 Hrs	*Decay	500 Hrs	*Decay	1000 Hrs	*Decay	Remark
VF	V	1.389	1.392	0.263	1.385	-0.240	1.387	-0.142	
IR	μA	0.087	0.084	-0.003	0.052	-0.036	0.054	-0.033	
IOH1	A	-1.152	-1.135	0.017	-1.097	0.055	-1.081	0.071	
IOH2	A	-1.900	-1.884	0.016	-1.831	0.069	-1.814	0.087	
IOL1	A	0.699	0.712	0.013	0.689	-0.010	0.680	-0.018	
IOL2	A	1.363	1.384	0.021	1.370	0.007	1.369	0.007	
VOH	V	9.686	9.724	0.399	9.712	0.278	9.701	0.159	
VOL	V	0.256	0.262	2.616	0.274	6.925	0.282	10.275	
ICCH	mA	1.735	1.728	-0.396	1.670	-3.774	1.623	-6.306	
ICCL	mA	1.717	1.717	0.006	1.722	0.278	1.714	0.027	
IFLH	mA	2.485	2.546	0.061	2.828	0.343	3.695	1.161	
VFHL	mA	1.045	1.171	0.126	1.177	0.132	1.186	0.139	

*Decay of VF, VOH, VOL, ICCH and ICCL are "%Delta" / *Decay of IR, IOH, IOL, VFLH and IFLH are "Delta"

LITEON LITE-ON TECHNOLOGY CORPORATION

Property of LITE-ON Only

Low Temp Storage Life (LTSL) (Pre-Conditioning)									
Parameter	Unit	0 Hr	168 Hrs	*Decay	500 Hrs	*Decay	1000 Hrs	*Decay	Remark
VF	V	1.389	1.393	0.253	1.387	-0.187	1.389	-0.133	
IR	μA	0.086	0.083	-0.004	0.050	-0.036	0.055	-0.031	
IOH1	A	-1.148	-1.133	0.015	-1.103	0.045	-1.115	0.036	
IOH2	A	-1.896	-1.885	0.012	-1.856	0.041	-1.865	0.036	
IOL1	A	0.696	0.708	0.012	0.690	-0.006	0.687	-0.009	
IOL2	A	1.361	1.382	0.020	1.370	0.009	1.372	0.012	
VOH	V	9.684	9.723	0.401	9.713	0.303	9.718	0.340	
VOL	V	0.257	0.265	2.911	0.275	6.773	0.273	6.185	
ICCH	mA	1.733	1.730	-0.158	1.731	-0.104	1.726	-0.132	
ICCL	mA	1.715	1.709	-0.245	1.719	0.333	1.713	0.251	
IFLH	mA	2.527	2.566	0.039	2.128	-0.399	1.723	-0.794	
VFHL	mA	1.051	1.173	0.122	1.178	0.127	1.152	0.100	

*Decay of VF, VOH, VOL, ICCH and ICCL are "%Delta" / *Decay of IR, IOH, IOL, VFLH and IFLH are "Delta"

Autoclave (AC) (Non-Preconditioning)					
Parameter	Unit	0 Hr	96 Hrs	*Decay	Remark
VF	V	1.382	1.392	0.734	
IR	μA	0.419	0.092	-0.326	
IOH1	A	-1.148	-1.127	0.022	
IOH2	A	-1.895	-1.900	-0.005	
IOL1	A	0.697	0.662	-0.034	
IOL2	A	1.362	1.368	0.005	
VOH	V	9.660	9.683	0.246	
VOL	V	0.331	0.263	-0.068	
ICCH	mA	1.706	1.725	1.097	
ICCL	mA	1.703	1.696	-0.371	
IFLH	mA	2.589	2.543	-0.046	
VFHL	mA	1.052	1.057	0.005	

*Decay of VF, VOH, VOL, ICCH and ICCL are "%Delta" / *Decay of IR, IOH, IOL, VFLH and IFLH are "Delta"

LITEON | LITE-ON TECHNOLOGY CORPORATION

Property of LITE-ON Only

ESD & Latch up

Applicant brief	
<p>光寶科技 LTV-155E SOP-5 B130123003</p> <p>Application:2013/01/23 Finish:2013/01/24 30124A-E</p>	<p>Human Body Model (HBM) ESDA/JEDEC JS-001-2010</p> <p>Equipment: <u>Thermo KeyTek Zapmaster 7/4(G)</u> Temperature: <u>25°C ±5°C</u> Humidity: <u>55% ±10% RH</u> Failure Criteria: A: <u>I-V curve drift:</u> <u>voltage changes more than ± 30% at ± 1uA reference current.</u> <u>V+I envelope around pre-zap REFERENCE I-V curve.</u> (I tolerance ± 30% ; V tolerance ± 30%.) Absolute At $I-V \leq 6V$, $I > 10\mu A$</p> <p>Test Voltage: <u>500V(±)~8000V(±)</u> Step:<u>500V</u></p>

Human Body Model (HBM) Testing Result													
<p><u>Sensitivity Pass:8000V</u></p> <p><u>Class: 3B</u></p> <p>follow standerd: ESDA/JEDEC JS-001-2010</p> <p>Class-0 : <249V Class-1A: 250V-<499V Class-1B: 500V-<999V Class-1C: 1000V-<1999V Class-2 : 2000V-<3999V Class-3A: 4000V-<7999V Class-3B: >8000V</p>	<table border="1"> <thead> <tr> <th>Pin Combination</th> <th>Sample</th> <th>Pass</th> </tr> </thead> <tbody> <tr> <td>Anode(±)-Cathode</td> <td rowspan="4" style="text-align: center;">3</td> <td style="text-align: center;">8000</td> </tr> <tr> <td>Vo(±)-GND</td> <td style="text-align: center;">8000</td> </tr> <tr> <td>Vo(±)-Vcc</td> <td style="text-align: center;">8000</td> </tr> <tr> <td>Vcc(±)-GND</td> <td style="text-align: center;">8000</td> </tr> </tbody> </table>	Pin Combination	Sample	Pass	Anode(±)-Cathode	3	8000	Vo(±)-GND	8000	Vo(±)-Vcc	8000	Vcc(±)-GND	8000
Pin Combination	Sample	Pass											
Anode(±)-Cathode	3	8000											
Vo(±)-GND		8000											
Vo(±)-Vcc		8000											
Vcc(±)-GND		8000											

* Remark: *: DUT failed at first level of customer defined test condition. Note: Red color in raw data indicates failed pins, if any.

LITEON | LITE-ON TECHNOLOGY CORPORATION

Property of LITE-ON Only

Applicant brief	
<p>光寶科技 LTV-155E SOP-5 B130123003</p> <p>Application:2013/01/23 Finish:2013/01/24 30124A-E</p>	<p>Machine Model(MM) JESD22-A115C</p> <p>Equipment: <u>Thermo KeyTek Zapmaster 7/4(G)</u> Temperature: <u>25°C ±5°C</u> Humidity: <u>55% ±10% RH</u> Failure Criteria: <u>IV curve drift:</u> <u>voltage changes more than ± 30% at ± 1uA reference current.</u> <u>V+I envelope around pre-zap REFERENCE I-V curve.</u> (I tolerance ± 30% ; V tolerance ± 30%.) Absolute At $-V \leq 6V, I > 10\mu A$ Test Voltage: <u>100V(±)~2000V(±)</u> Step:<u>100V</u></p>

Machine Model(MM) Testing Result													
<p><u>Sensitivity Pass:1000V</u></p> <p><u>Class: C</u></p> <p>follow standard: JESD22-A115C</p> <p>Class-A: <199V Class-B: 200V-<399V Class-C: >400V</p>	<table border="1"> <thead> <tr> <th>Pin Combination</th> <th>Sample</th> <th>Pass</th> </tr> </thead> <tbody> <tr> <td>Anode(±)-Cathode</td> <td rowspan="4">3</td> <td>2000</td> </tr> <tr> <td>Vo(±)-GND</td> <td>1000</td> </tr> <tr> <td>Vo(±)-Vcc</td> <td>1100</td> </tr> <tr> <td>Vcc(±)-GND</td> <td>1100</td> </tr> </tbody> </table>	Pin Combination	Sample	Pass	Anode(±)-Cathode	3	2000	Vo(±)-GND	1000	Vo(±)-Vcc	1100	Vcc(±)-GND	1100
Pin Combination	Sample	Pass											
Anode(±)-Cathode	3	2000											
Vo(±)-GND		1000											
Vo(±)-Vcc		1100											
Vcc(±)-GND		1100											

* Remark: *: DUT failed at first level of customer defined test condition. Note: Red color in raw data indicates failed pins, if any.

LITEON | LITE-ON TECHNOLOGY CORPORATION

Property of LITE-ON Only

Applicant brief	
<p>光寶科技 LTV-155E SOP-5 B130123003</p> <p>Application:2013/01/23 Finish:2013/01/24 30124A-E</p>	<p>Charged Device Model (Socket CDM)</p> <p>ANSI / ESD SP5.3.2-2008</p> <p>Equipment: <u>Thermo KeyTek Zapmaster 7/4(G)</u></p> <p>Temperature: <u>25°C ±5°C</u> Humidity: <u>55% ±10% RH</u></p> <p>Failure Criteria: <u>A;IV curve drift:</u> <u>voltage changes more than ± 30% at ± 1uA reference current.</u> <u>V+I envelope around pre-zap REFERENCE I-V curve.</u> (I tolerance ± 30% ; V tolerance ± 30%.) Absolute At $-V \leq 6V$, $I > 10\mu A$</p> <p>Test Voltage: <u>100V(±)~2000V(±)</u> Step:<u>100V</u></p>

Charged Device Mode (CDM) Test Report															
<p><u>Sensitivity Pass: 2000V</u></p> <p><u>Class: 5</u></p> <p><u>follow standard:</u> ANSI / ESD SP5.3.2-2008</p> <p>1 : 250V 2 : 500V 3 : 750V 4 : 1000V 5 : 1250V</p>	<table border="1"> <thead> <tr> <th>Pin Combination</th> <th>Sample</th> <th>Pass</th> </tr> </thead> <tbody> <tr> <td>Anode(±)-Cathode</td> <td rowspan="4" style="text-align: center;">3</td> <td style="text-align: center;">2000</td> </tr> <tr> <td>Vo(±)-GND</td> <td style="text-align: center;">2000</td> </tr> <tr> <td>Vo(±)-Vcc</td> <td style="text-align: center;">2000</td> </tr> <tr> <td>Vcc(±)-GND</td> <td style="text-align: center;">2000</td> </tr> </tbody> </table>			Pin Combination	Sample	Pass	Anode(±)-Cathode	3	2000	Vo(±)-GND	2000	Vo(±)-Vcc	2000	Vcc(±)-GND	2000
Pin Combination	Sample	Pass													
Anode(±)-Cathode	3	2000													
Vo(±)-GND		2000													
Vo(±)-Vcc		2000													
Vcc(±)-GND		2000													

* Remark: *: DUT failed at first level of customer defined test condition. Note: Red color in raw data indicates failed pins, if any.

LITEON | LITE-ON TECHNOLOGY CORPORATION

Property of LITE-ON Only

Latch Up Test (LUT)

Test Condition:

- Trigger Current: 100mA~400mA (\pm), Step: 50mA (\pm)
- Vsupply OVER VOLTAGE Test: 30V (+) ~ 40V (+), Step +1V (+)

Test Result:

TRIGGER MODEL	TEST PIN	SAMPLE SIZE	TRIGGER SOURCE INDUCE LATCH-UP	IT CLASS: <u>3</u> NOTE:
+IT	I/P	3	PASS	CLASS 1: +IT: 0mA~+39mA -IT: 0mA~-39mA
	O/P		PASS	
-IT	I/P	3	PASS	CLASS 2: +IT: 40mA~+99mA -IT: -40mA~-99mA
	O/P		PASS	
Vsupply OVER VOLTAGE TEST	VCC	3	PASS	CLASS 3: +IT: >100mA -IT: <100mA

LITEON | LITE-ON TECHNOLOGY CORPORATION

Property of LITE-ON Only

8.0 Packing specification

LITEON LITE-ON TECHNOLOGY CORPORATION

Property of LITE-ON Only

LTV-155E PACKING DATA

LITEON LITE-ON Technology Corp.	
CUSTOMER :	
CUS.PART.NO. :	
MATERIAL NO. :	
LOT NO. :	
QUANTITY :	
BATCH :	
LPN :	
DATE CODE :	DATE CODE2:
MACHINE :	
COMMENT :	
Pb-Free/RoHS	

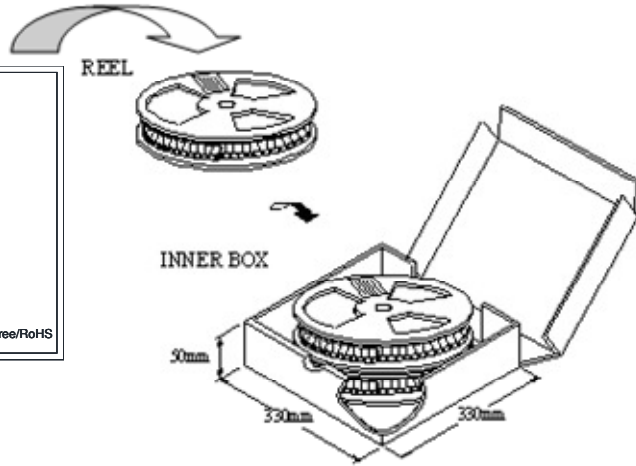

LITEON LITE-ON Technology Corp.	
CUSTOMER :	
CUS.PART.NO. :	
MATERIAL NO. :	
LOT NO. :	
QUANTITY :	
BATCH :	
LPN :	
DATE CODE :	DATE CODE2:
MACHINE :	
COMMENT :	
Pb-Free/RoHS	

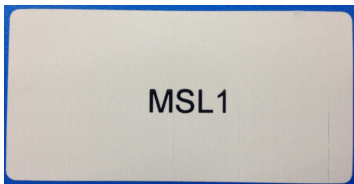
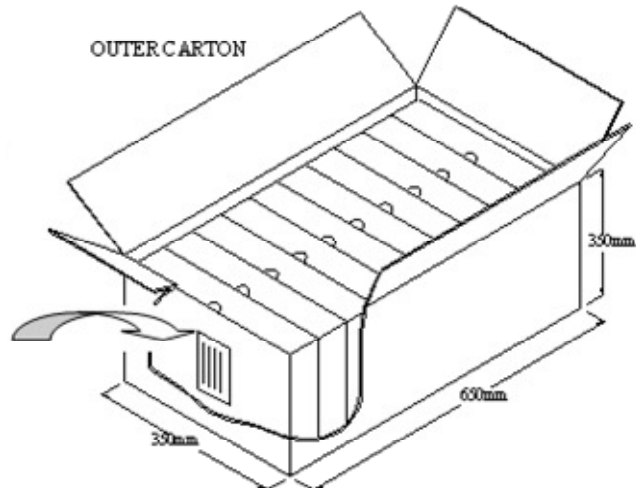

MSL label: This label will be attached on inner & outer cartons additionally

LITEON LITE-ON TECHNOLOGY CORPORATION

Property of LITE-ON Only

REEL PIZZA BOX LABEL :

↑ **LITEON** LITE ON ELECTRONICS CO.,LTD.
CUSTOMER:

CUS.PART.NO.:

MATERIAL NO.



LOT NO.:

QUANTITY

BATCH:

LPN:

DATE CODE:

MACHINE:

COMMENT

↓ Pb-free/RoHS MADE IN CHINA

103mm

58mm

Reel packing photo



Material:

1. Carrier: Conductive Polystyrene Alloy
2. Reel : Polystyrene

LITEON | LITE-ON TECHNOLOGY CORPORATION

Property of LITE-ON Only

9.0 QC Flow

LITEON LITE-ON TECHNOLOGY CORPORATION

Property of LITE-ON Only

9.1. Assembly QC Flow











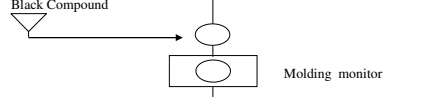

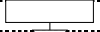
Process / Quality Control Plan

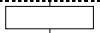
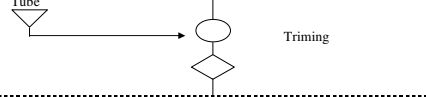
Area Number : 70
 Product : Photo Coupler
 Part Name / Device : LTV-155E
 Key Contact / Phone : Mr.Sin

Process	Process Flow Chart	Process Control	Tooling
Receiving			
IQC		L/F - Dimension. - Visual DICE - Elec trical - Visual	Profile Projector Curve Tracer
Store		Temp. Control 25±5 FIFO	
Dice preparation (110)		Silver Epoxy storage 3 months Silver Epoxy storage temp. < -15 ° C Dice expansion temp control 60±5 ° C	Refrigerator Refrigerator Dice expansion M/C
Auto Mount		Check Appearance Dice Shear (IR side) : $\bar{X}-R$ CHART Dice position : $\bar{X}-R$ CHART	Power Microscope Bond Shear Power Microscope
Auto Bonding		Check Appearance : 5 times/ shift Ball shear : $\bar{X}-R$ CHART Pull tension : $\bar{X}-R$ CHART Loop Height : $\bar{X}-R$ CHART	Power Microscope Bond Shear Gramgauge Measuring
Auto Coating		Check Appearance : Every 6 Time / Shift Dipping position : Record sheet Curing after coating Time 145 ± 5 min Temp 170 ± 5 ° C Coating thickness : $\bar{X}-R$ CHART	Microscope Microscope
1st Molding		Compound storage : under 0 ° C Die Temp : 175 ± 5 ° C Preheat Temp. Temp 73 ± 5 ° C Transfer Time As specified Transfer pressure 40 ± 10 kg/cm.cm	Thermometer Thermometer Visual check Stop watch Display

LITEON LITE-ON TECHNOLOGY CORPORATION

Property of LITE-ON Only

Process	Process Flow Chart	Process Control	Tooling
1-st D/T			
2-nd Molding		Die Temp : 175 ± 5 °C Preheat Temp. : Temp 83 ± 5 °C Transfer Time : As specified Transfer pressure : 40 + 10 kg/cm.cm	-Thermometer -Visual check -Stop watch -Display
2-nd D/T		Post curing Temp : Temp 175 ± 5 °C Post curing Time : Time 4 ± 0.5 hour	-OVEN -OVEN
Store		Checking quantity	-Visual Inspection
Solder Plating			
I.Q.C and Store Receiving		Quantity Confriming Incoming insp. Solder plating : As specific Tin thickness : As specific	
Trim & From		100% Inspec.	
		Lead width : \bar{X} -R CHART Lead spread : \bar{X} -R CHART	-Projector
Inspection		100 % inspection	
Test & Mark		100% HIGH voltage & EE test : AS specific 100% Marking	-Tester -CCD Auto Inspection
Packing		Quantity = 100 % insp. Marking = 100% insp.	
Store		100 % inspection	
Out going inspection. Shipping		Temp control 25 ± 5 °c FIFO Sampling AQL=0.1%(3 lot/day)	
Reliability test		1. Operation life 2. High temp % & High Humidity Reverse bias 3. High temp reverse bias 4. High temp storage 5. Low temp storage 6. Auto clave 7. Temp cycle 8. Thermal Shock 9. Solder Resis temp 10. Solder ability	-Life Tester -Humidity chamber -Oven -Oven -Ultra freeze chamber -Pressure Cooker -Temp cycle -Thermal Shock -Wetting balance -Wetting balance
		End	

LITEON LITE-ON TECHNOLOGY CORPORATION

Property of LITE-ON Only

9.2. FAB QC Flow

No	Manufacturing	Characteristics	Control Method		
	Process	Product / Process	Specification	Method	Frequency
1	Wafer launch	Total Piece	-	Recording & Scanning	Per Wafer
2	Pre Evaporation Cleaning	Appearance	As SOP	Visual Inspection	1 Time/Batch
3	BM Metal evaporation	Back Thickness	As SOP	α -Step	3 Point/Batch
4	BM Masking	Appearance	As SOP	Microscope	Per Wafer
5	BM Etching	Appearance	As SOP	Microscope	Per Wafer
6	Sintering	Resistance	As SOP	Rs Tester	5 Point/Pcs
		Appearance	As SOP	Microscope	Per Wafer
7	Pre Evaporation Cleaning	Appearance	As SOP	Visual Inspection	1 Time/Batch
8	2M Metal evaporation	Front Thickness	As SOP	α -Step	3 Point/Batch
9	2M Masking	Appearance	As SOP	Microscope	Per Wafer
10	2M Etching	Appearance	As SOP	Microscope	Per Wafer
11	Sintering	Resistance	As SOP	Rs Tester	5 Point/Pcs
		Appearance	As SOP	Microscope	Per Wafer
12	Peeling Test	Bonding and Shear force	As SOP	Shear Force Tester	9 Point/1 Wafer/Lot
				Tape	Per Wafer
13	Half Sawing	Sawing Depth	As SOP	High Magnification Microscope	1 Pcs/3Pcs
		Appearance	As SOP	Microscope	Per Wafer
14	Cleaning	Appearance	As SOP	Timer alarm	1 Time/Batch
15	100% Probing	Electrical Characteristic	As SOP	Selected-Program Confirmation	1 Time/Pcs
16	Full Sawing	Appearance	As SOP	Microscope	Per Wafer
17	Cleaning	Appearance	As SOP	Microscope	Per Wafer
18	Extension	Gap	AS SOP	Microscope	1 Time/Batch
19	Cleaning	Appearance	As SOP	Microscope	Per Wafer
20	Sampling Test	E.O Characteristic	As SOP	E.O. Tester	Over 40 ea/Pcs
21	Bonding Test	Bonding and Shear Force Test	As SOP	Shear Force Tester	9 Point/1 Wafer/Lot
22	QA Inspection	Electrical Characteristic	As SOP	E.O. Tester	ASQC Z.1.4 L S3 AQL 0.65
23	Visual Inspection	Appearance	As SOP	Microscope	Per Wafer
24	QA Inspection	Appearance	As SOP	Microscope	ASQC Z.1.4 L II AQL 0.015
25	Sampling Test	Thickness	As SOP	Thickness meter	Per Wafer
26	Splitting and Packaging	Package Spec	As SOP	Visual Inspection	Per Wafer
27	Counting and Labeling	Q'ty / Label Check	As SOP	Visual check	Random
28	QA Inspection	Appearance	As SOP	Visual Inspection	1Time /5Package
		Data Checking	As SOP	Visual Inspection	Per tape/1Time /5Package
29	Warehouse	-	-	-	-

Property of LITE-ON Only

9.3. Abnormal Lot checking flow in final test

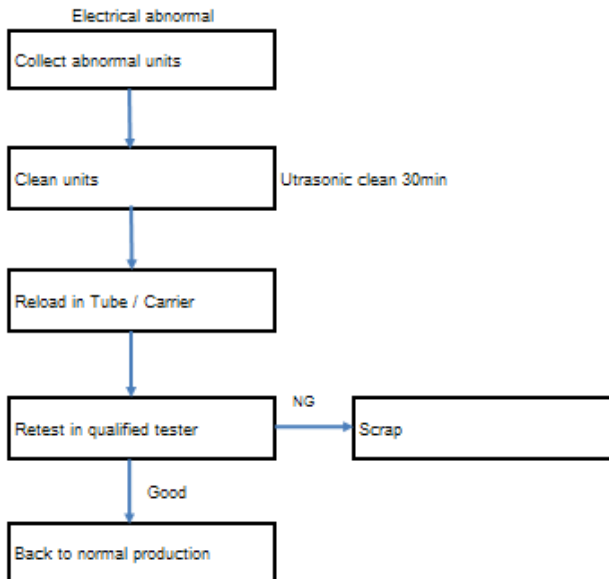
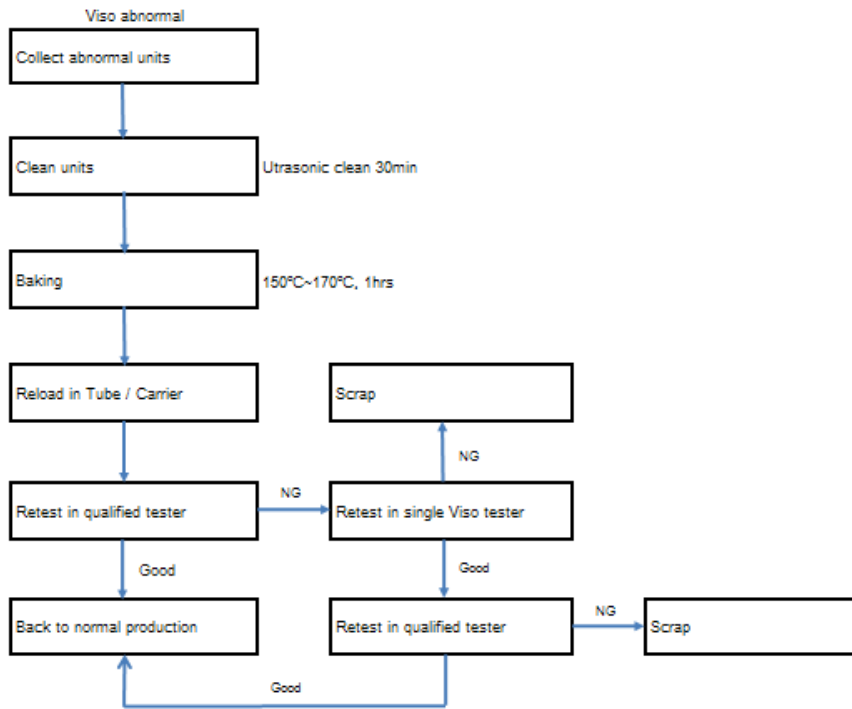

LITEON LITE-ON TECHNOLOGY CORPORATION

Property of LITE-ON Only

9.4 Testing QC flow

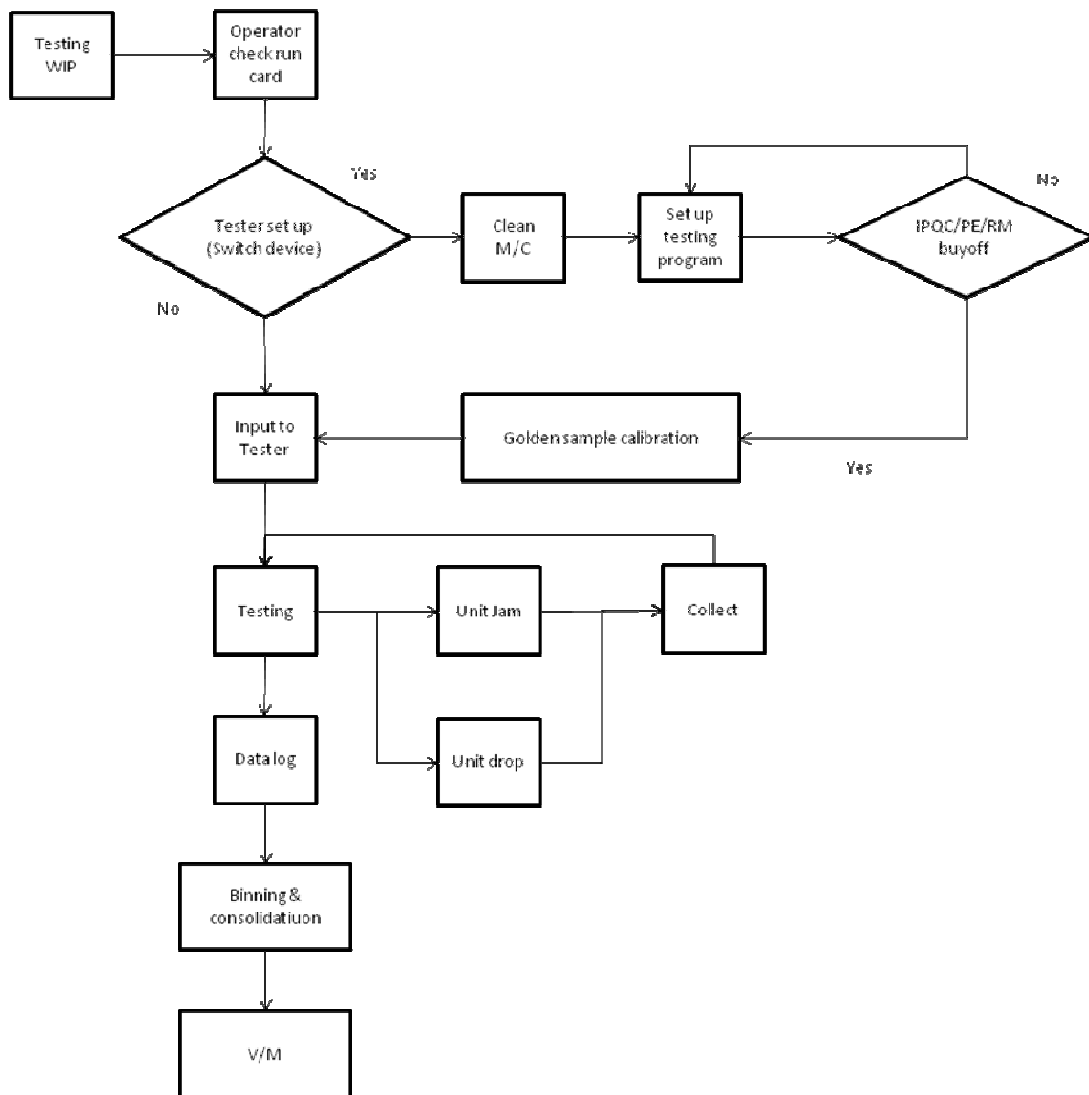

LITE-ON | LITE-ON TECHNOLOGY CORPORATION

Property of LITE-ON Only

10.0 Manufacturing Control Plan

▽ MATERIAL 材料 ○ MATERIAL 製程 □ PROCESS CONTROL 製程管制

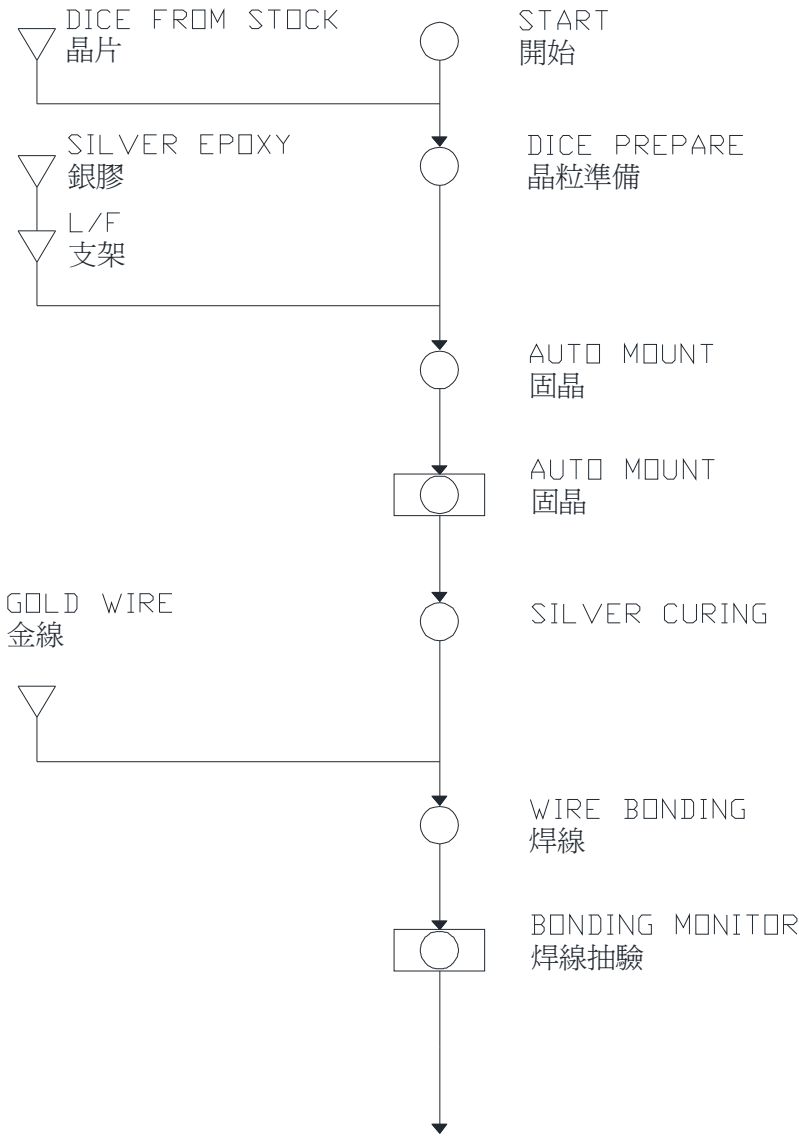

LITEON LITE-ON TECHNOLOGY CORPORATION

Property of LITE-ON Only

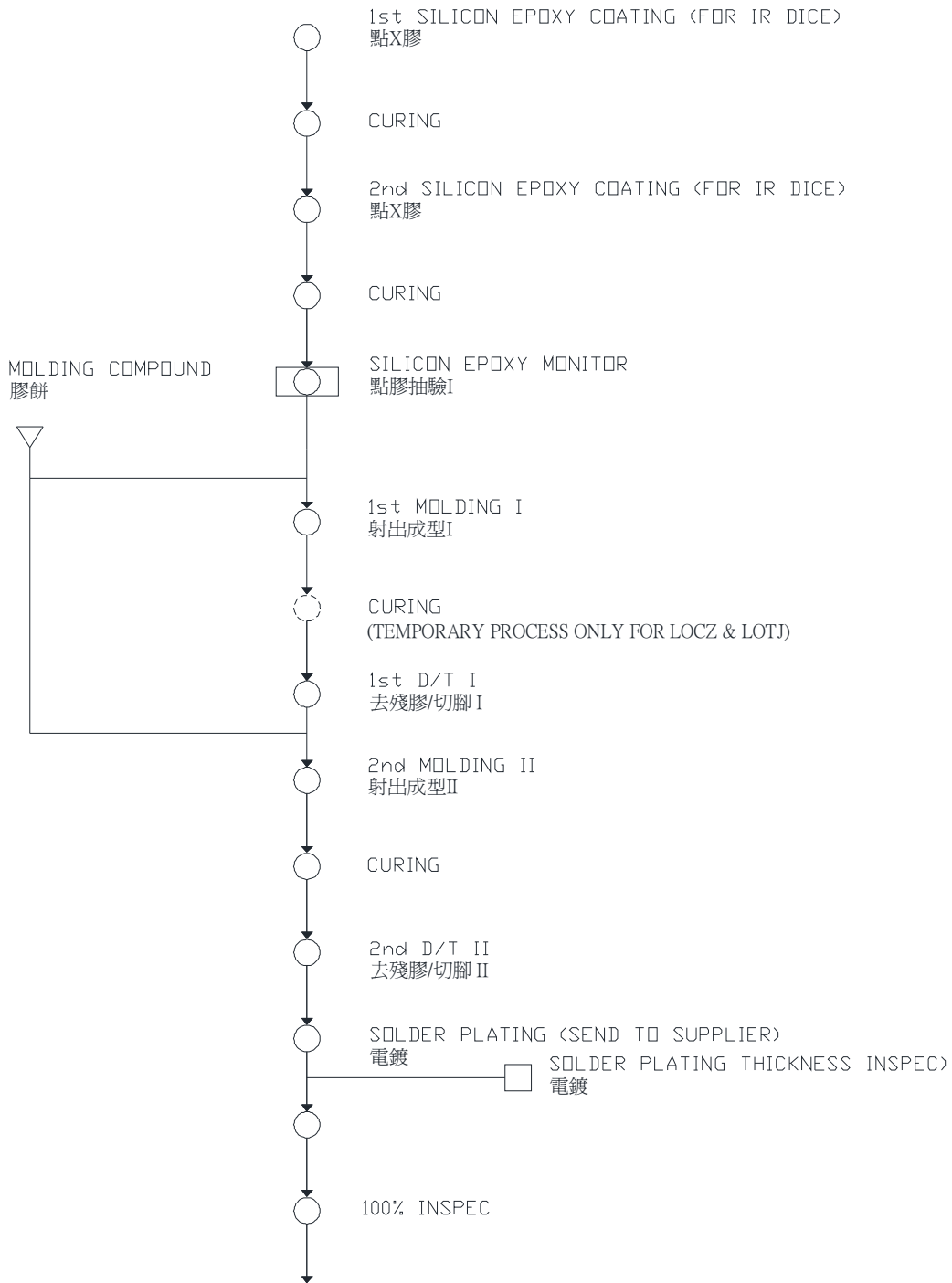

LITEON | LITE-ON TECHNOLOGY CORPORATION

Property of LITE-ON Only

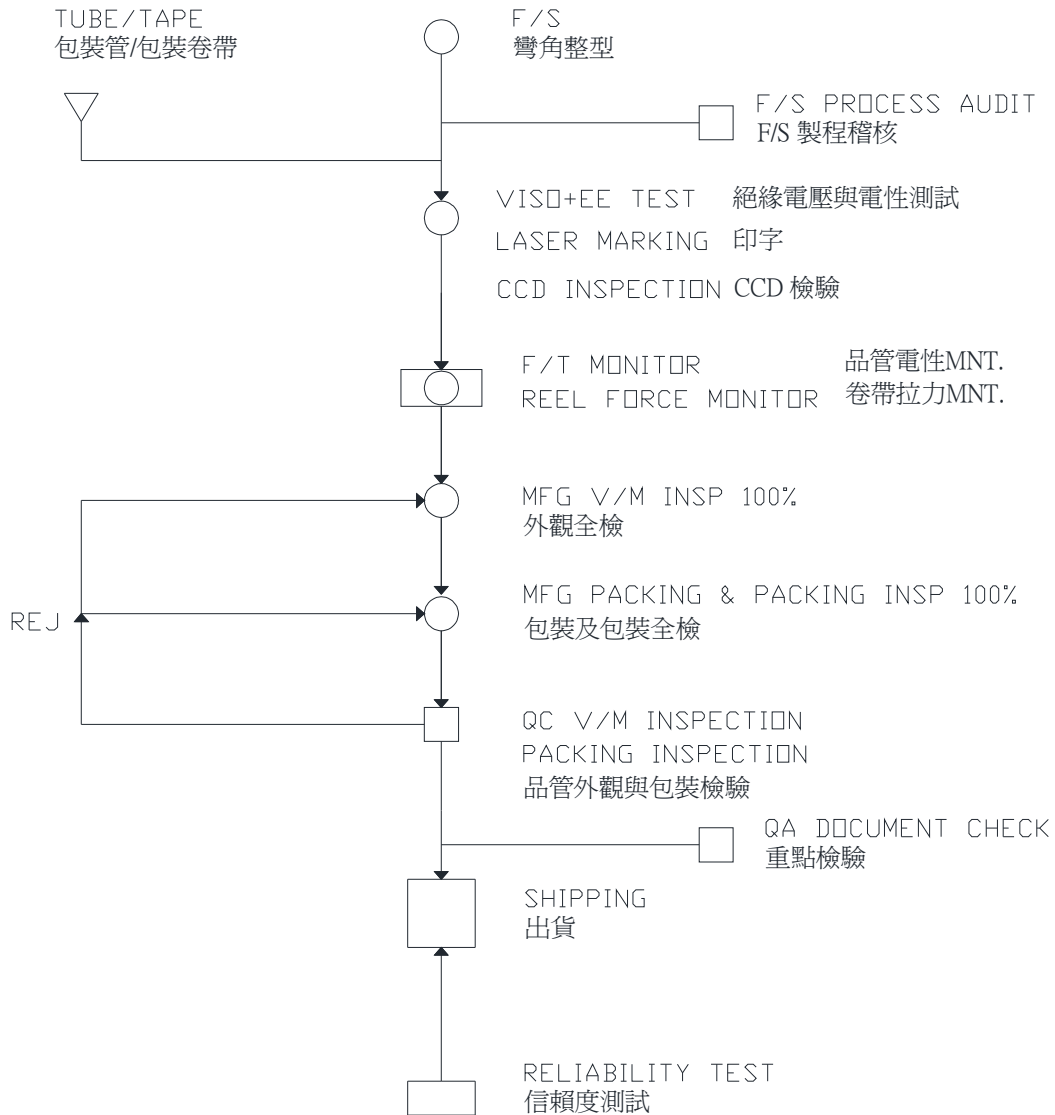

LITEON LITE-ON TECHNOLOGY CORPORATION

Property of LITE-ON Only

11.0 Electrical Characteristics

11.1 Actual measured value of product electrical characters

	VF1(V)	VBR(V)	IR1(uA)	IOPH1(A)	IOPH2(A)	IOPL1(A)	IOPL2(A)	VOH(V)
Min	1.2	5	-	-	-	0.2	0.4	9
Typ	1.37	-	-	-0.5	-	0.5	-	9.55
Max	1.8	-	10	-0.2	-0.4	-	-	-
No.1	1.38	16.40	0.08	-1.13	-1.91	0.69	1.36	9.68
No.2	1.39	11.52	0.08	-1.12	-1.90	0.68	1.35	9.68
No.3	1.39	16.66	0.08	-1.16	-1.91	0.69	1.36	9.69
No.4	1.38	14.92	0.08	-1.16	-1.91	0.70	1.36	9.69
No.5	1.39	14.92	0.07	-1.14	-1.90	0.70	1.38	9.68
No.6	1.40	16.84	0.08	-1.11	-1.86	0.68	1.36	9.67
No.7	1.39	14.64	0.08	-1.17	-1.92	0.69	1.37	9.69
No.8	1.39	16.66	0.08	-1.17	-1.92	0.70	1.36	9.69
No.9	1.39	15.52	0.08	-1.17	-1.93	0.69	1.36	9.69
No.10	1.38	14.59	0.08	-1.16	-1.90	0.70	1.36	9.69
No.11	1.39	16.52	0.08	-1.14	-1.89	0.70	1.38	9.68
No.12	1.40	11.60	0.08	-1.15	-1.90	0.69	1.37	9.68
No.13	1.39	16.85	0.08	-1.14	-1.89	0.70	1.37	9.68
No.14	1.38	14.64	0.09	-1.15	-1.90	0.70	1.37	9.68
No.15	1.39	16.37	0.07	-1.16	-1.92	0.70	1.36	9.69
No.16	1.38	14.52	0.08	-1.15	-1.88	0.70	1.35	9.69
No.17	1.40	14.32	0.08	-1.12	-1.90	0.69	1.36	9.68
No.18	1.40	16.54	0.08	-1.13	-1.87	0.69	1.37	9.68
No.19	1.38	12.99	0.06	-1.15	-1.90	0.70	1.37	9.69
No.20	1.38	16.05	0.07	-1.12	-1.88	0.68	1.35	9.68
No.21	1.40	16.68	0.08	-1.15	-1.89	0.69	1.35	9.68
No.22	1.38	16.21	0.08	-1.17	-1.94	0.69	1.35	9.69
No.23	1.40	14.42	0.08	-1.17	-1.93	0.69	1.36	9.69
No.24	1.38	16.43	0.08	-1.16	-1.91	0.70	1.37	9.69
No.25	1.40	16.01	0.08	-1.15	-1.91	0.70	1.37	9.68
No.26	1.39	16.69	0.08	-1.16	-1.92	0.70	1.36	9.69
No.27	1.39	15.13	0.08	-1.16	-1.92	0.70	1.35	9.69
No.28	1.39	15.16	0.08	-1.14	-1.88	0.69	1.37	9.68
No.29	1.38	11.25	0.08	-1.16	-1.90	0.69	1.35	9.69
No.30	1.39	15.21	0.08	-1.15	-1.90	0.69	1.36	9.68
Min	1.38	11.25	0.06	-1.17	-1.94	0.68	1.35	9.67
Max	1.40	16.85	0.09	-1.11	-1.86	0.70	1.38	9.69
Avg	1.39	15.21	0.08	-1.15	-1.90	0.69	1.36	9.68

LITEON LITE-ON TECHNOLOGY CORPORATION

Property of LITE-ON Only

	VOL(V)	ICCH(mA)	ICCL(mA)	IFLH(mA)	VFHL(V)	tpLH(nS)	tpHL(nS)	tr(nS)	tf(nS)
Min	-	-	-	-	0.8	50	50	-	-
Typ	0.3	1.5	1.5	2.6	-	115	110	30	15
Max	1	3	3	7.5	-	200	200	-	-
No.1	0.26	1.67	1.65	2.89	1.07	115	111	29	18
No.2	0.26	1.68	1.65	2.89	1.07	117	113	30	19
No.3	0.26	1.71	1.68	2.58	1.07	118	114	31	18
No.4	0.26	1.69	1.66	2.03	1.03	119	115	29	18
No.5	0.25	1.72	1.69	1.88	1.03	120	116	29	19
No.6	0.27	1.71	1.68	2.19	1.07	118	113.8	29	17
No.7	0.26	1.75	1.74	3.13	1.07	114	110	30	18
No.8	0.25	1.70	1.69	3.13	1.07	113	109	30	18
No.9	0.26	1.72	1.71	2.43	1.07	112	108	30	17
No.10	0.26	1.66	1.67	2.51	1.07	113	109	30	19
No.11	0.25	1.77	1.76	2.11	1.03	112	108	29	17
No.12	0.26	1.77	1.75	2.27	1.07	113	108.8	30	18
No.13	0.25	1.77	1.75	2.82	1.03	112	108	29	17
No.14	0.25	1.80	1.77	2.66	1.03	114	110	29	18
No.15	0.25	1.70	1.67	1.96	1.03	114	110	31	19
No.16	0.26	1.67	1.66	2.34	1.07	114	110	30	17
No.17	0.26	1.72	1.72	2.19	1.07	113	109	29	18
No.18	0.26	1.81	1.80	2.74	1.07	113	109.4	30	18
No.19	0.26	1.74	1.73	1.80	1.07	115	111	30	17
No.20	0.26	1.69	1.69	3.05	1.07	116	112	29	17
No.21	0.26	1.73	1.71	2.66	1.03	114	110	29	19
No.22	0.26	1.72	1.70	2.66	1.07	115	111	30	18
No.23	0.26	1.73	1.71	2.03	1.07	116	112	28	19
No.24	0.25	1.78	1.78	2.74	1.03	117	113	29	17
No.25	0.25	1.73	1.70	2.66	1.07	114	110	29	19
No.26	0.26	1.75	1.72	2.58	1.03	113	109	29	18
No.27	0.26	1.72	1.70	2.82	1.07	114	110	31	18
No.28	0.26	1.78	1.78	2.58	1.03	113	109	30	18
No.29	0.26	1.74	1.70	2.43	1.03	115	111	28	19
No.30	0.26	1.73	1.71	2.51	1.06	115	111	30	18
Min	0.25	1.66	1.65	1.80	1.03	112	108	28	17
Max	0.27	1.81	1.80	3.13	1.07	120	116	31	19
Avg	0.26	1.73	1.71	2.51	1.06	114.69	110.69	29.52	18

LITEON LITE-ON TECHNOLOGY CORPORATION

Property of LITE-ON Only

11.2 Actual measured value of important electrical characteristics by operation temperature

	VOH(max temp 100°C)	VOH(min temp -40°C)	VOL(max temp 100°C)	VOL(min temp -40°C)
Condition	VCC=10V, IF = 10mA, IO = -100mA		VCC=10V, IF = 0mA, IO = 100mA	
Unit	V		V	
Min	9.00	9.00	-	-
Typ	9.55	9.55	0.30	0.30
Max	-	-	1.00	1.00
1	9.43	9.65	0.46	0.24
2	9.42	9.65	0.48	0.22
3	9.44	9.65	0.48	0.23
4	9.45	9.64	0.47	0.23
5	9.43	9.66	0.48	0.24
6	9.43	9.66	0.47	0.22
7	9.43	9.65	0.46	0.23
8	9.42	9.65	0.46	0.24
9	9.45	9.65	0.46	0.23
10	9.44	9.64	0.47	0.23
11	9.45	9.65	0.47	0.22
12	9.43	9.65	0.46	0.22
13	9.42	9.66	0.48	0.23
14	9.43	9.66	0.46	0.22
15	9.44	9.64	0.48	0.24
16	9.45	9.65	0.47	0.23
17	9.43	9.64	0.46	0.23
18	9.43	9.66	0.46	0.24
19	9.42	9.64	0.48	0.23
20	9.45	9.65	0.47	0.22
21	9.43	9.65	0.47	0.22
22	9.44	9.65	0.48	0.24
23	9.44	9.64	0.48	0.23
24	9.45	9.66	0.47	0.23
25	9.42	9.64	0.46	0.24
26	9.43	9.66	0.47	0.23
27	9.43	9.64	0.47	0.22
28	9.42	9.66	0.48	0.24
29	9.44	9.66	0.47	0.22
30	9.45	9.64	0.47	0.24
Min	9.42	9.64	0.46	0.22
Max	9.45	9.66	0.48	0.24
Avg	9.435	9.650	0.470	0.230

LITEON LITE-ON TECHNOLOGY CORPORATION

Property of LITE-ON Only

	IOPH1(max temp 100°C)	IOPH1(min temp -40°C)	IOL1(max temp 100°C)	IOL1(min temp -40°C)
Condition	Vcc=15V, IF=10mA, V6-5=2V		Vcc=15V, IF=0mA, V5-4=2V	
Unit	A		A	
Min	-	-	0.20	0.20
Typ	-0.50	-0.50	0.50	0.50
Max	-0.20	-0.02	-	-
1	-0.46	-0.67	0.47	0.71
2	-0.46	-0.66	0.49	0.71
3	-0.48	-0.67	0.47	0.73
4	-0.47	-0.67	0.47	0.71
5	-0.47	-0.66	0.48	0.72
6	-0.46	-0.68	0.47	0.72
7	-0.48	-0.67	0.48	0.73
8	-0.46	-0.68	0.47	0.71
9	-0.48	-0.67	0.48	0.73
10	-0.46	-0.66	0.47	0.72
11	-0.48	-0.67	0.47	0.73
12	-0.47	-0.66	0.49	0.72
13	-0.48	-0.67	0.47	0.71
14	-0.46	-0.68	0.49	0.73
15	-0.47	-0.67	0.48	0.71
16	-0.47	-0.67	0.47	0.72
17	-0.48	-0.68	0.49	0.71
18	-0.47	-0.67	0.47	0.73
19	-0.48	-0.66	0.48	0.71
20	-0.46	-0.67	0.47	0.72
21	-0.48	-0.68	0.49	0.71
22	-0.47	-0.67	0.47	0.72
23	-0.47	-0.66	0.48	0.73
24	-0.48	-0.68	0.49	0.72
25	-0.47	-0.66	0.49	0.73
26	-0.48	-0.67	0.48	0.72
27	-0.46	-0.68	0.49	0.72
28	-0.47	-0.67	0.49	0.71
29	-0.48	-0.67	0.48	0.73
30	-0.48	-0.68	0.49	0.73
Min	-0.48	-0.68	0.47	0.71
Max	-0.46	-0.66	0.49	0.73
Avg	-0.471	-0.670	0.479	0.720

LITEON | LITE-ON TECHNOLOGY CORPORATION

Property of LITE-ON Only

	TPLH(max temp 100°C)	TPLH(min temp -40°C)	TPHL(max temp 100°C)	TPHL(min temp -40°C)
Condition	VCC=20V, IF= 10mA, Rg= 30, Cg= 1 nF,, f= 250 kHz,, Duty= 50%			
Unit	ns		ns	
Min	50.00	50.00	50.00	50.00
Typ	115.00	115.00	110.00	110.00
Max	200.00	200.00	200.00	200.00
1	145	106	140	91
2	145	108	143	91
3	146	106	140	93
4	145	108	140	94
5	146	107	141	91
6	146	108	143	92
7	149	106	141	92
8	146	107	141	93
9	149	106	140	92
10	149	106	142	91
11	145	108	143	93
12	147	108	142	91
13	149	108	142	93
14	149	107	141	94
15	146	108	142	93
16	146	107	143	92
17	148	107	142	92
18	146	108	143	91
19	145	107	140	94
20	145	106	142	93
21	148	106	143	94
22	149	107	142	93
23	148	107	140	92
24	145	108	143	92
25	146	107	140	94
26	145	107	142	93
27	148	108	143	94
28	149	107	141	91
29	148	106	141	94
30	149	108	143	94
Min	145.00	106.00	140.00	91.00
Max	149	108	143	94
Avg	146.900	107.100	141.633	92.567

LITEON LITE-ON TECHNOLOGY CORPORATION

Property of LITE-ON Only

11.3 Actual measured value of important electrical characteristics by voltage

Condiiton	ICCH		ICCL	
	VCC=10V IF = 10mA, VO=Open	VCC=30V IF = 10mA, VO=Open	VCC=10V IF = 0mA, VO=Open	VCC=30V IF = 0mA, VO=Open
Unit	mA		mA	
Min	-	-	-	-
Typ	1.5	1.5	1.5	1.5
Max	3	3	3	3
1	1.49	1.66	1.52	1.67
2	1.51	1.66	1.52	1.67
3	1.5	1.67	1.52	1.67
4	1.5	1.66	1.53	1.68
5	1.5	1.67	1.53	1.67
6	1.51	1.66	1.52	1.67
7	1.5	1.67	1.52	1.68
8	1.51	1.67	1.53	1.67
9	1.49	1.66	1.52	1.67
10	1.49	1.66	1.52	1.68
11	1.51	1.67	1.53	1.67
12	1.49	1.66	1.52	1.67
13	1.5	1.67	1.53	1.68
14	1.51	1.66	1.52	1.68
15	1.5	1.66	1.53	1.68
16	1.51	1.67	1.52	1.68
17	1.49	1.66	1.53	1.68
18	1.49	1.66	1.52	1.67
19	1.51	1.67	1.53	1.67
20	1.49	1.66	1.52	1.68
21	1.49	1.66	1.52	1.67
22	1.51	1.66	1.53	1.67
23	1.49	1.67	1.52	1.68
24	1.49	1.66	1.52	1.68
25	1.51	1.67	1.53	1.67
26	1.5	1.67	1.52	1.67
27	1.5	1.67	1.53	1.68
28	1.49	1.67	1.52	1.68
29	1.49	1.66	1.53	1.68
30	1.51	1.66	1.53	1.67
Min	1.49	1.66	1.52	1.67
Max	1.51	1.67	1.53	1.68
Avg	1.499	1.664	1.524	1.675

LITEON LITE-ON TECHNOLOGY CORPORATION

Property of LITE-ON Only

	TPLH(VCC=10V)	TPLH(VCC=30V)	TPHL(VCC=10V)	TPHL(VCC=30V)
Condiiton	IF= 10mA, Rg= 30, Cg= 1 nF, f= 250 kHz., Duty= 50%			
Unit	ns		ns	
Min	50.00	50.00	50.00	50.00
Typ	115.00	115.00	110.00	110.00
Max	200.00	200.00	200.00	200.00
1	110	119	107	111
2	112	120	108	115
3	110	120	107	112
4	112	120	108	111
5	111	119	106	112
6	112	118	107	115
7	110	120	108	112
8	112	121	107	112
9	110	119	107	115
10	112	118	108	112
11	111	120	107	113
12	112	122	106	111
13	111	118	107	115
14	110	122	107	112
15	111	119	106	115
16	110	118	106	115
17	110	119	108	111
18	111	118	107	112
19	110	122	106	111
20	112	118	107	114
21	112	118	106	111
22	112	122	106	112
23	110	119	107	114
24	111	119	108	112
25	112	119	106	114
26	110	118	106	114
27	112	118	107	111
28	111	122	108	111
29	110	118	107	114
30	112	122	108	111
Min	110	118	106	111
Max	112	122	108	115
Avg	111.033	119.500	106.967	112.667

LITEON | LITE-ON TECHNOLOGY CORPORATION

Property of LITE-ON Only

12.0 Actual Measurement Value of each Exterior Part

LITEON LITE-ON TECHNOLOGY CORPORATION

Property of LITE-ON Only

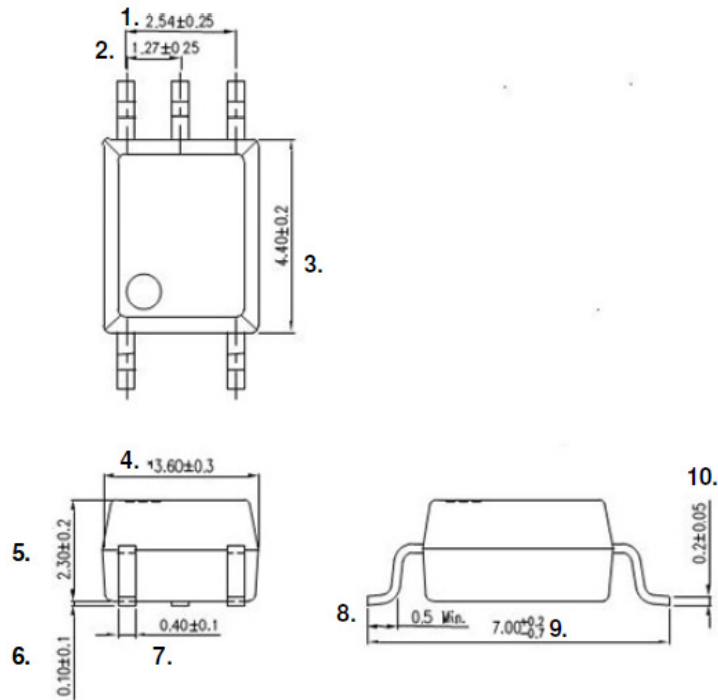

All Dimensions in Millimeters

	1	2	3	4	5	6	7	8	9	10
1	2.552	1.276	4.388	3.615	2.33	0.083	0.4	0.643	6.935	0.203
2	2.465	1.285	4.418	3.614	2.332	0.055	0.42	0.682	6.917	0.205
3	2.512	1.271	4.393	3.591	2.31	0.112	0.43	0.639	6.905	0.21
4	2.488	1.277	4.365	3.602	2.312	0.139	0.412	0.642	6.906	0.206
5	2.479	1.282	4.444	3.606	2.33	0.111	0.411	0.637	6.924	0.199
6	2.541	1.273	4.441	3.612	2.31	0.104	0.398	0.666	6.903	0.198
7	2.551	1.277	4.399	3.613	2.331	0.083	0.405	0.688	6.912	0.201
8	2.548	1.276	4.387	3.642	2.329	0.09	0.407	0.654	6.922	0.204
9	2.491	1.272	4.366	3.608	2.299	0.103	0.398	0.643	6.945	0.212
10	2.541	1.291	4.379	3.632	2.301	0.107	0.402	0.672	6.895	0.204
11	2.553	1.264	4.442	3.643	2.33	0.08	0.411	0.642	6.932	0.203
12	2.547	1.271	4.412	3.601	2.311	0.064	0.415	0.631	6.915	0.212
13	2.531	1.277	4.376	3.58	2.335	0.101	0.389	0.656	6.924	0.198
14	2.542	1.275	4.442	3.584	2.332	0.077	0.406	0.673	6.935	0.197
15	2.553	1.288	4.411	3.591	2.312	0.105	0.395	0.665	6.936	0.202
16	2.541	1.29	4.382	3.579	2.307	0.103	0.394	0.638	6.928	0.204
17	2.554	1.294	4.392	3.605	2.309	0.111	0.403	0.652	6.92	0.242
18	2.498	1.277	4.408	3.611	2.305	0.08	0.407	0.648	6.924	0.217
19	2.512	1.281	4.482	3.591	2.331	0.072	0.402	0.662	6.926	0.2
20	2.544	1.277	4.482	3.591	2.306	0.085	0.412	0.648	6.884	0.201
21	2.543	1.271	4.376	3.605	2.311	0.092	0.399	0.639	6.873	0.204
22	2.549	1.276	4.4	3.604	2.309	0.076	0.398	0.671	6.882	0.206
23	2.551	1.292	4.382	3.601	2.301	0.059	0.402	0.683	6.861	0.199
24	2.555	1.289	4.412	3.606	2.334	0.111	0.401	0.678	6.879	0.208
25	2.553	1.277	4.445	3.62	2.311	0.104	0.405	0.682	6.858	0.2
26	2.541	1.271	4.442	3.611	2.329	0.078	0.403	0.692	6.872	0.2
27	2.465	1.265	4.382	3.598	2.307	0.124	0.41	0.693	6.865	0.197
28	2.491	1.262	4.422	3.588	2.301	0.095	0.399	0.683	6.843	0.205
29	2.512	1.255	4.438	3.612	2.335	0.085	0.397	0.667	6.888	0.201
30	2.553	1.271	4.366	3.611	2.324	0.092	0.395	0.654	6.873	0.2

LITEON LITE-ON TECHNOLOGY CORPORATION

Property of LITE-ON Only

13.0 Mean Time to Failure



MTTF/ FIT report for LTV-155E

(Mean time to failure / Failure rate report)

(According to MIL-STD-690C)

Sample size	1080 Pcs		
Test Hours	1000 Hours		
Total Hours	1080000 Hours		
Total Failure	0 Pcs		
Typical MTTF	1080000 Hours	r	1
Typical Failure rate/1Khours	0.0925926 %		
@ 90% Confidence level			
MTTF <i>more than or equal</i>	469035 Hours		
FIT/1Khours <i>less than or equal</i>	3.53 FIT		

Note: if no failures occurred during testing, the typical MTTF and the Failure rate calculated assuming one (1) failure.

Sample size = Monthly routine operating test x sample size of every time

Test Hours = 1000 (Hours)

Total Hours = Sample size x Test Hours

Total failures = Failure number of yearly test.

Typical MTTF = Total hours / Total failure (T/r)

Typical failure rate (%) = (1/Typical MTTF) x 1000 x 100

MTTF @ 90% CL = Typical MTTF/Critical value at 90%CL (from GEM table)

FITs : $\frac{nc(n)*109}{N*t*A}$ (Refer to Intrinsic Failure Rate (IFR))

$\frac{N*t*A}{N*t*A}$

**Follow as WI-QA-00999-046 MTTF (Mean Time To Failure) to be study Wearout.

LITEON LITE-ON TECHNOLOGY CORPORATION

Property of LITE-ON Only

14.0 Delaminating Evaluation

1. Inner mold & Outer mold

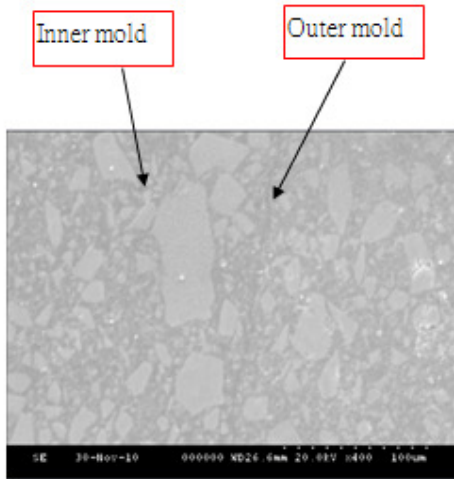

2. LED & Silver epoxy & LF

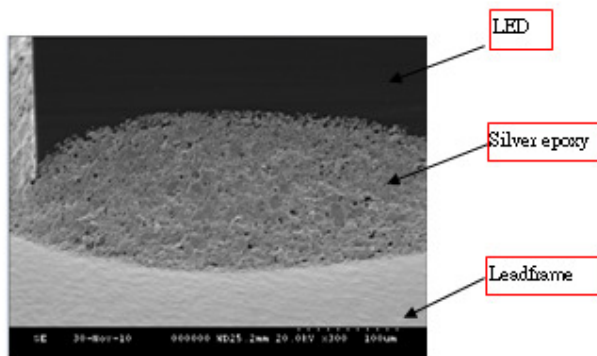

3. Coating gel & Inner mold

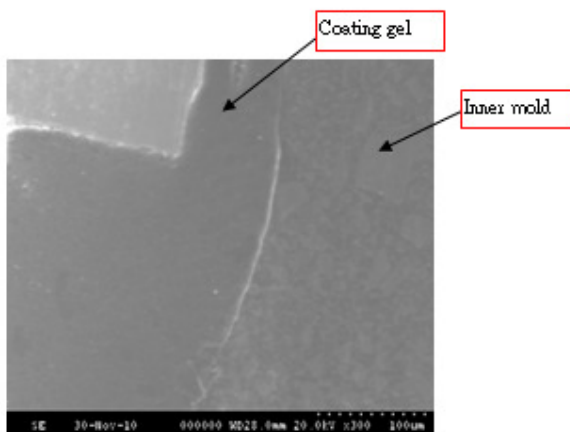

LITEON LITE-ON TECHNOLOGY CORPORATION

Property of LITE-ON Only

4. Inner mold & LF

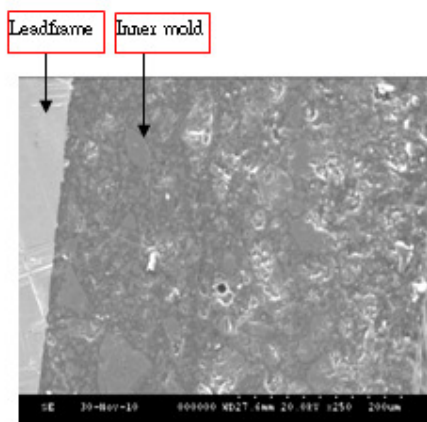

5. Outer mold & LF

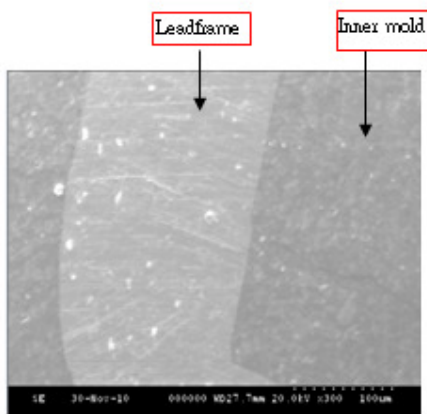

LITEON LITE-ON TECHNOLOGY CORPORATION

Property of LITE-ON Only

15.0 CTQ Actual Measurement Results in QC Flow

NO.	Process	Check item	Fail Mode	SPEC	Qty	Result	1	2	3	4	5	6	7	8	9	10	11	12.00	13.00	
1	Wire Bond(IR)	Wire pull	refer to photo1	7.0(min)	20	MAX	15.45	12.91	13.49	13.93	13.84	14.12	14.57	14.04	14.29	14.44	14.56	14.02	14.55	14.47
						Mfin	12.91													
						AVG	14.24													
2	Die Bond(IR)	Die shear	refer to photo2	60(min)	20	MAX	300	267.28	237.17	255.84	260.52	259.27	258.45	284.38	288.96	264.47	267.19	266.57	258.43	245.00
						Mfin	161													
						AVG	244													
3	Die Bond(PTR)	Wire pull	refer to photo1	4.1(min)	20	MAX	13.7	12.96	12.27	12.55	12.82	13.31	12.51	13.15	13.65	13.00	13.23	13.28	13.28	12.80
						Mfin	12.2													
						AVG	12.9													
4	Die Bond(PTR)	ball shear	refer to photo2	25(min)	20	MAX	93.7	76.96	78.05	76.43	74.24	61.79	62.70	78.67	86.40	93.71	77.08	84.51	69.78	89.36
						Mfin	61.8													
						AVG	79.1													

14.00	15.00	16.00	17.00	18.00	19.00	20.00	21.00	22.00	23.00	24.00	25.00	26.00	27.00	28.00	29.00	30.00
14.28	14.97	15.45	14.55	14.45	14.02	13.95	14.56	14.18	14.35	13.87	14.20	14.57	13.93	14.12	14.32	13.99
173.60	167.30	292.30	161.00	196.40	174.40	300.00	285.43	281.11	278.32	252.42	267.19	266.57	255.55	264.42	266.38	261.30
12.15	12.17	12.17	13.01	12.46	13.65	13.11	11.64	11.68	11.73	11.91	11.81	11.87	11.58	10.81	12.08	10.56
81.02	77.14	80.01	75.04	91.85	88.41	78.47	64.39	56.34	73.13	68.56	73.06	57.05	59.77	53.22	62.76	68.70

6.3 推金球和拉力效果判定/Judgement of ball shear & pull tension effect :

6.3.1 推金球效果判定(Ball shear effect judgement):

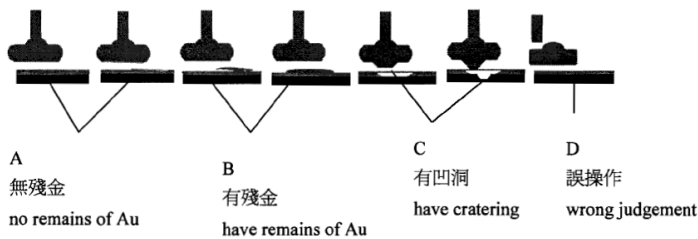

注釋:

1. 推球後任何一點為C種狀況則判定為不良.
2. 推球後如全部為A種狀況則判定為不良.
3. 推球後如為D種狀況則判定為誤判, QC需重新測試.

LITEON LITE-ON TECHNOLOGY CORPORATION

Property of LITE-ON Only

Location	Failure mode	Description	Result
LOTJ	A	No gold remain on the pad (Dice) after wire pull (ball shift)	Reject
	B	Break off from the neck of the loop, little higher upon the ball (<2mil)	Accept
	C	Break off from between B & D point	Accept
	D	Break off from the tail of the loop (tail remain on the pad)	Accept
	E	No gold remain on the pad after wire pull (tail shift)	Reject
LOBK	A	Lifted ball	Reject
	B	Wire break at neck bond	Accept
	C	Loop wire break	Accept
	D	Stitch bond (Wire break at stitch)	Accept
	E	Weld lifted	Reject
	F	Gold remain >80% on pad	Accept
	G	Gold remain 50-80% on pad	Accept
	H	Gold remain 10-50% on pad	Accept
	I	Gold remain <10% on pad	Reject
	J	Peeling pad	Reject

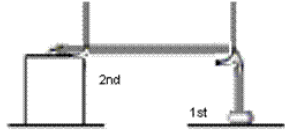
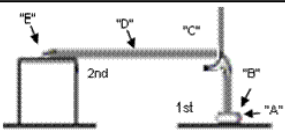

LITEON LITE-ON TECHNOLOGY CORPORATION

Property of LITE-ON Only

16.0 MSDS/SGS

Material Safety Data Sheet

物質安全資料表

一、物品與廠商資料/Product and Company Identification

物品名稱： Photocoupler Product Name
物品編號： LTV-155E Product Code
製造商或供應商名稱、地址及電話： Address & Tel. of Manufacturer or Agent LITEON TECHNOLOGY CORPORATION 90, Chien 1 Rd, Chung Ho dist. New Taipei city, Taiwan R.O.C.
緊急聯絡電話/傳真電話： +886-222226181 #1252 Emergency Phone Number/Fax

二、成分辨識資料/Composition, Information on Ingredients

1.

In substance fame is called: Epoxy Compound		
Chemical nature : Resin		
The substance component name	CAS number	Concentration either concentration limit (component percentage)
White compound	25068-38-6	42.63%
Black compound	25068-38-6	57.37%

2.

In substance fame is called : Lead frame		
Physical property : Metal		
The substance component name	CAS number	Concentration either concentration limit (component percentage)
Copper	7440-50-8	99.2%
Silver	140415-84-5	0.8%

LITEON | LITE-ON TECHNOLOGY CORPORATION

Property of LITE-ON Only

3.

In substance fame is called : Emitter chip		
Physical property :		
The substance component name	CAS number	Concentration either concentration limit (component percent)
Gallium Arsenide	7440-55-3	
Ga		51.4%
As		48.6%

4.

In substance fame is called : Detector chip		
Physical property :		
The substance component name	CAS number	Concentration either concentration limit (component percentage)
Silicon	7440-21-3	99.726%
Aluminum	7429-90-5	0.163%
Copper	7440-50-8	0.001%
Tungsten	7440-33-7	0.11%

5.

In substance fame is called : Golden wire		
Physical property : Au		
The substance component name	CAS number	Concentration either concentration limit (component percentage)
Au	7440-57-5	100%

6.

In substance fame is called : Ag Paste		
Physical property :		
The substance component name	CAS number	Concentration either concentration limit (component percentage)
Ag-based Epoxy	14391-65-2	
Epoxy Resin		17.64%
Ag		82.36%

LITEON LITE-ON TECHNOLOGY CORPORATION

Property of LITE-ON Only

7.

In substance fame is called : Silicon gel		
Physical property :		
The substance component name	CAS number	Concentration either concentration limit (component percentage)
Silicone	63148-62-9	
Si		10%~20%
Epoxy-resin		Remain

三、危害辨識資料/ Hazard Identification

最重要危害效應 Most Important Health Hazards and Reactions	健康危害效應/Health Hazards and Reactions : N/A
	環境影響/Environmental Impact : N/A
	物理性及化學性危害/Physical and Chemical Hazards : N/A
	特殊危害/Specific Hazards : N/A
主要症狀/Cardinal Symptoms : N/A	
物品危害分類/Hazard Classification : N/A	

四、急救措施/ First Aid Measures

不同暴露途徑之急救方法/ First Aid Measures for Different Kinds of Exposures : <ul style="list-style-type: none">• 吸入/Inhalation : N/A• 皮膚接觸/Skin Contact : N/A• 眼睛接觸/Eye Contact : N/A• 食入/Ingestion : N/A
最重要症狀及危害效應/Most Important Symptoms and Hazard Reactions : N/A
對急救人員之防護/Protection to First-Aid Attendants : N/A
對醫師之提示/Suggestions to Doctors : N/A

LITEON LITE-ON TECHNOLOGY CORPORATION

Property of LITE-ON Only

五、滅火措施/ Fire Fighting Measures

適用滅火劑/Suitable Extinguishing Media : Water 、Carbon dioxide 、Dried vermicelli made from bean starch fire-extinguishing chemical

滅火時可能遭遇之特殊危害/Special Hazards in Fire : N/A

特殊滅火程序/Special Fire-Fighting Procedures : N/A

消防人員之特殊防護設備/Required Special Protective Equipment for Fire-Fighters : N/A

六、洩漏處理方法/ Accidental Release Measures

個人應注意事項/ Personal Precautions : N/A

環境注意事項/Environmental Precautions : N/A

清理方法/Methods for Cleaning : N/A

七、安全處置與儲存方法/ Handling and Storage

處置/Handling : N/A

儲存/ Storage : Temp:-55°C~150°C

八、暴露預防措施/ Exposure Controls, Personal Protection

工程控制/ Engineering Measures : N/A

控制參數/ Control Parameters :

- 八小時日時量平均容許濃度(TWA)/短時間時量平均容許濃度(STEL)/最高容許濃度 (CEILING) : N/A
- 生物指標/ BEIs : N/A

個人防護設備/ Personal Protection Equipment :

- 呼吸防護/Respiration : N/A
- 手部防護/Hand : N/A
- 眼睛防護/Eye : N/A
- 皮膚及身體防護/Skin & Body : N/A

衛生措施/Hygiene Measures : N/A

LITEON LITE-ON TECHNOLOGY CORPORATION

Property of LITE-ON Only

九、物理及化學性質/ Physical and Chemical Properties

物質狀態/ State of Substance : solid	形狀/Appearance : Square-like
顏色/Color : N/A	氣味/Odor : N/A
pH 值/pH Value : N/A	沸點/沸點範圍/Boiling Point : N/A
分解溫度/Decomposing Temperature : 无	閃火點 : °F °C Flashpoint 測試方法 : 開杯 閉杯 Test Methods : Open Slot Closed Slot
自燃溫度/Self-Igniting Temperature : N/A	爆炸界限/Explosion Limits : N/A
蒸氣壓/Vapor Pressure : N/A	蒸氣密度/Vapor Density : N/A
密度/Density : N/A	溶解度/Dissolution : N/A

十、安定性及反應性/Stability and Reactivity

安定性/Stability : N/A
特殊狀況下可能之危害反應/Possible Hazard Reaction Under Special Conditions : N/A
應避免之狀況/Conditions to Avoid : N/A
應避免之物質/Materials to Avoid : N/A
危害分解物/Hazardous Decomposition Products : N/A

十一、毒性資料/ Toxicological Information

急毒性/Acute Toxicity : N/A
局部效應/Local Reactions : N/A
致敏感性/Sensitivity : N/A
慢毒性或長期毒性/Chronic or Long Term Toxicity : N/A
特殊效應/Special Reactions : N/A

十二、生態資料/ Ecological information

可能之環境影響/環境流佈/Possible Environmental Impact/Environmental Run-offs : N/A

LITEON | LITE-ON TECHNOLOGY CORPORATION

Property of LITE-ON Only

十三、廢棄處置方法/Disposal considerations

廢棄處置方法/Disposal Methods : N/A

十四、運送資料/Transport information

國際運送規定/International Transportation Regulations : N/A

聯合國編號/UN Reference No. : N/A

國內運送規定/Domestic Transportation Regulations : N/A

特殊運送方法及注意事項/Special Transportation Methods and Precautions : N/A

十五、法規資料/Regulatory information

適用法規/Applicable Regulation : J-STD-020D

十六、其他資料/Other information

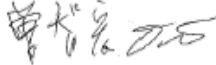
參考文獻 Ref. Document	
製表單位 Department	名稱/Dept. Name : LITE-ON ELECTRONICS(TIANJIN) CO.,LTD 地址/電話 Address/Tel. : 90, Chien 1 Rd, Chung Ho dist. New Taipei city, Taiwan R.O.C./+886222226181#1252
製表人 Made By	職稱/Title : PD Principle Engineer 姓名(簽章) Name(Signature) :  Dio Tzeng
製表日期 Date Prepared	Jan. 1, 2013

*. SGS report please see attachment.

Mouser Electronics

Authorized Distributor

Click to View Pricing, Inventory, Delivery & Lifecycle Information:

[Lite-On:](#)

[LTV-155E](#)