

Multimec™ 3F

High performance tactile switches •
robust



DISTINCTIVE FEATURES

10 x 10 mm; h=10.4 mm

Illuminated RAS option

Slip-on cap retention system - great for custom caps



ENVIRONMENTAL SPECIFICATIONS

- Sealing : IP67 according to IEC 60529
- Working and storage temperature :
 - non-illuminated : -40 °C/+160 °C (-40 °F to +320 °F)
 - illuminated : -20 °C /+80 °C (-4 °F to +176 °F)
- Soldering :
 - through-hole : IEC 60068-2-20 8
 - surface mount : JEDEC J-STD-020E



ELECTRICAL SPECIFICATIONS

- Recommended load :
 - Gold contacts : 0.5µ-50 mA 24 VDC
 - Silver contacts : 0.5-50 mA 24 VDC
- Contact resistance : <30 mΩ - typically 10 mΩ
- Insulation resistance : >10 MΩ
- Contact bounce : <2 mS - typically 0.5 mS



MECHANICAL SPECIFICATIONS

- Standard actuation force : 3.5 N
- Max. actuation force : 100 N for 10 sec
- Travel : 1 mm
- Lifetime : >10,000,000 cycles



MATERIALS

- Housing : PPS UL94V0
- Actuator : PPS UL94V0
- Sealing : Silicone rubber
- Contacts spring : Stainless steel
 - Silver : +3 µAg
 - Gold : +1 µAu
- Fixed contacts :
 - Silver : SnCu + 2 µNI + 3 µAg
 - Gold : SnCu + 2 µNI + 1 µAu
- Terminals : SnCu + 2 µNI + 3 µSn100

The company reserves the right to change specifications without notice.

4006-022-002

All tolerance if not otherwise specified ±0.2 mm.

shunto@126.com



Multimec™ 3F

High performance tactile switches • robust

3F - SMD

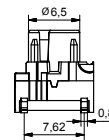
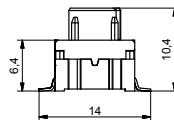
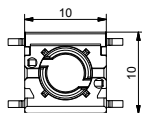

3F - TH

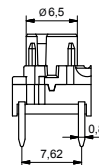
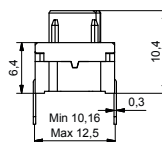
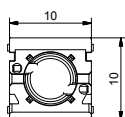

3F - TH W/LED

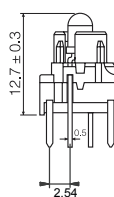
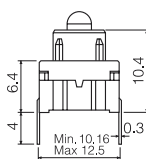
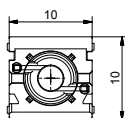

3F - RAS

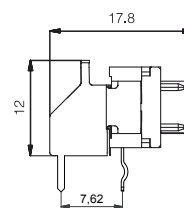
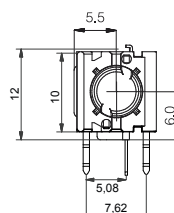
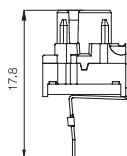

Multimec™ 3F

High performance tactile switches • robust

PCB SWITCHES

3F - RAS W/LED

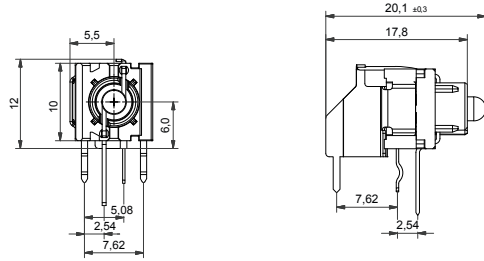
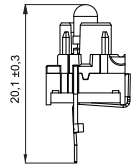

PCB LAYOUT & CIRCUIT DIAGRAM

TH Non-ill.

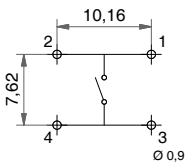

SMD non-ill.

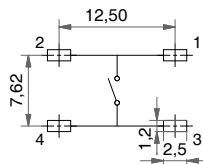

TH illuminated

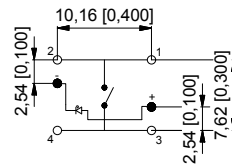

TH bi-color illuminated

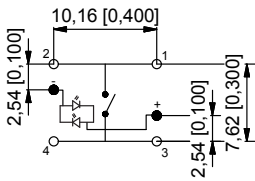

RAS

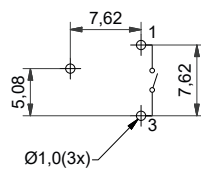

RAS illuminated

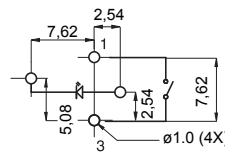

RAS bi-color illuminated

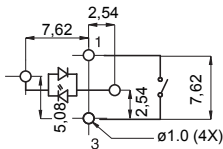

Multimec™ 3F

High performance tactile switches • robust

BUILD YOUR PART NUMBER

ILLUMINATED

<div style="border: 1px solid black; padding: 5px; width: 40px; margin: 0 auto;">3F</div> <p>.....</p> <p>SERIES</p>	<div style="border: 1px solid black; padding: 5px; width: 40px; margin: 0 auto;">—</div> <p>.....</p> <p>MOUNTING</p> <div style="border: 1px solid black; padding: 2px; display: inline-block; margin-right: 5px;">TH9</div> through-hole	<div style="border: 1px solid black; padding: 5px; width: 40px; margin: 0 auto;">—</div> <p>.....</p> <p>LED</p> <table border="0" style="width: 100%; border-collapse: collapse;"> <tr><td style="border: 1px solid black; padding: 2px;">06</td><td>blue</td></tr> <tr><td style="border: 1px solid black; padding: 2px;">20</td><td>green</td></tr> <tr><td style="border: 1px solid black; padding: 2px;">40</td><td>yellow</td></tr> <tr><td style="border: 1px solid black; padding: 2px;">65</td><td>white</td></tr> <tr><td style="border: 1px solid black; padding: 2px;">80</td><td>red</td></tr> <tr><td style="border: 1px solid black; padding: 2px;">2040</td><td>green/yellow</td></tr> <tr><td style="border: 1px solid black; padding: 2px;">8020</td><td>red/green</td></tr> <tr><td style="border: 1px solid black; padding: 2px;">8040</td><td>red/yellow</td></tr> <tr><td style="border: 1px solid black; padding: 2px;">24</td><td>high intensity green</td></tr> <tr><td style="border: 1px solid black; padding: 2px;">46</td><td>high intensity yellow</td></tr> <tr><td style="border: 1px solid black; padding: 2px;">87</td><td>high intensity red</td></tr> </table>	06	blue	20	green	40	yellow	65	white	80	red	2040	green/yellow	8020	red/green	8040	red/yellow	24	high intensity green	46	high intensity yellow	87	high intensity red	<div style="border: 1px solid black; padding: 5px; width: 40px; margin: 0 auto;">—</div> <p>.....</p> <p>OPTIONAL</p> <table border="0" style="width: 100%; border-collapse: collapse;"> <tr><td style="border: 1px solid black; padding: 2px;">Q</td><td>quiet contact</td></tr> <tr><td style="border: 1px solid black; padding: 2px;">G</td><td>gold contacts</td></tr> <tr><td style="border: 1px solid black; padding: 2px;">RAS</td><td>right angle</td></tr> </table>	Q	quiet contact	G	gold contacts	RAS	right angle
06	blue																														
20	green																														
40	yellow																														
65	white																														
80	red																														
2040	green/yellow																														
8020	red/green																														
8040	red/yellow																														
24	high intensity green																														
46	high intensity yellow																														
87	high intensity red																														
Q	quiet contact																														
G	gold contacts																														
RAS	right angle																														

NON-ILLUMINATED

<div style="border: 1px solid black; padding: 5px; width: 40px; margin: 0 auto;">3F</div> <p>.....</p> <p>SERIES</p>	<div style="border: 1px solid black; padding: 5px; width: 40px; margin: 0 auto;">—</div> <p>.....</p> <p>MOUNTING</p> <table border="0" style="width: 100%; border-collapse: collapse;"> <tr><td style="border: 1px solid black; padding: 2px;">TH9</td><td>through-hole</td></tr> <tr><td style="border: 1px solid black; padding: 2px;">SH9</td><td>surface mount</td></tr> </table>	TH9	through-hole	SH9	surface mount	<div style="border: 1px solid black; padding: 5px; width: 40px; margin: 0 auto;">—</div> <p>.....</p> <p>OPTIONAL</p> <table border="0" style="width: 100%; border-collapse: collapse;"> <tr><td style="border: 1px solid black; padding: 2px;">Q</td><td>quiet contact</td></tr> <tr><td style="border: 1px solid black; padding: 2px;">RAS</td><td>right angle (with TH only)</td></tr> <tr><td style="border: 1px solid black; padding: 2px;">R</td><td>tape & reel (with SMD only)</td></tr> <tr><td style="border: 1px solid black; padding: 2px;">G</td><td>gold contacts</td></tr> </table>	Q	quiet contact	RAS	right angle (with TH only)	R	tape & reel (with SMD only)	G	gold contacts
TH9	through-hole													
SH9	surface mount													
Q	quiet contact													
RAS	right angle (with TH only)													
R	tape & reel (with SMD only)													
G	gold contacts													

ABOUT THIS SERIES

 Caps and accessories : for the full range of accessories for Multimec™ 3F please see the website.

4006-022-002

shunto@126.com

Multimec™ 3F

High performance tactile switches • robust

PCB SWITCHES



TAPE & REEL

Tape and reel is available for the parts listed and has the following specifications

- Reel diameter: Ø330 mm
- Tape width: 24 mm
- Pitch: see list
- Tape and reel material: antistatic or better
- Quantity per reel: see list

PART NO.	ORDERING CODE	PITCH	QUANTITY PER REEL
3FSH9	3FSH9R	20	250



OPERATING FORCE

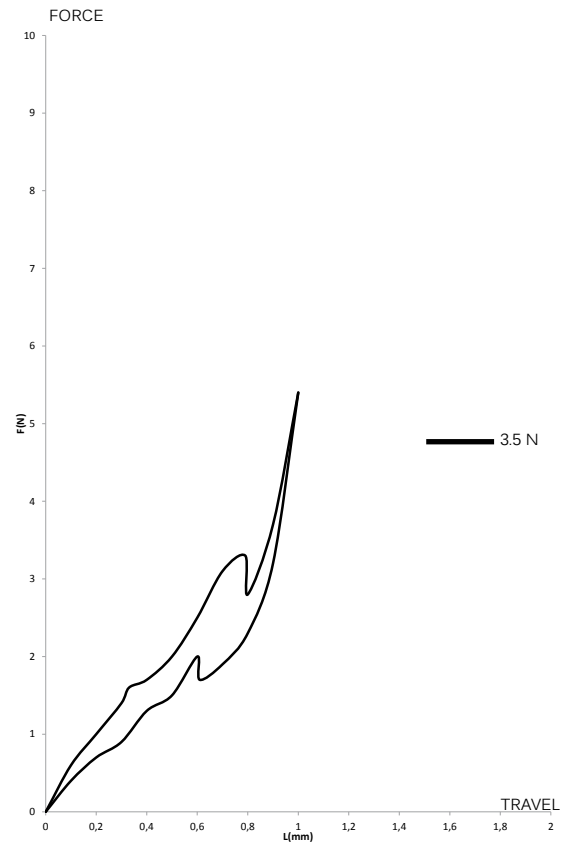

MOUNTING

MOUNTING TOOLS FOR MULTIMEC™ THROUGH-HOLE SWITCHES

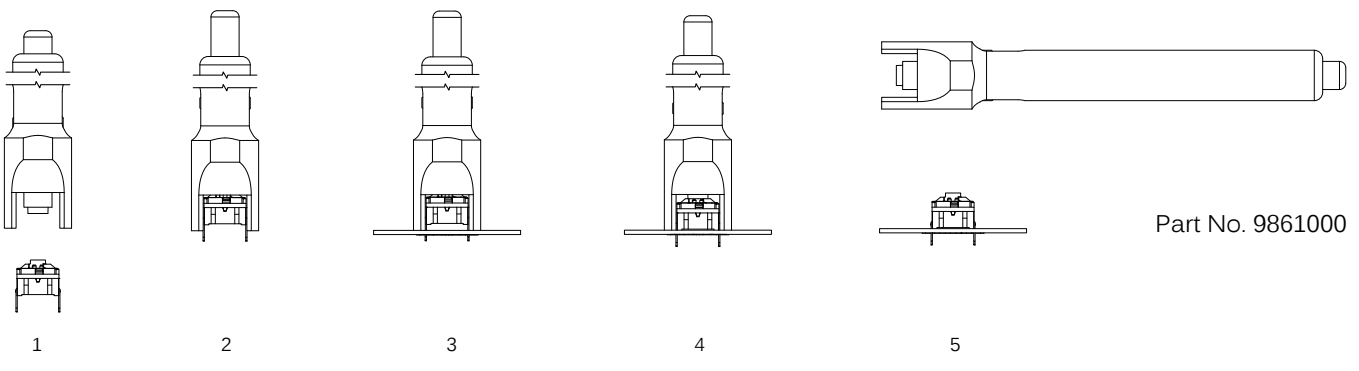

APEM

Multimec™ 3F

High performance tactile switches • robust

MOUNTING (CONTINUED)

SPACE REQUIREMENT - MATRIX MOUNTING

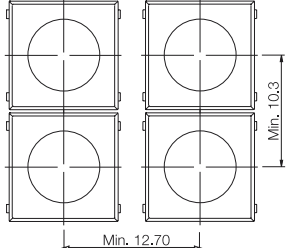

Through-hole (TH)

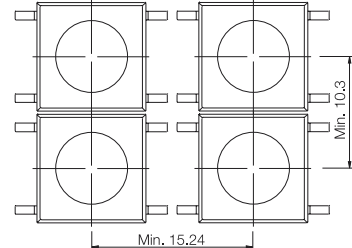

Surface mount (SMD)

MULTIMEC™ SPACING EXAMPLES

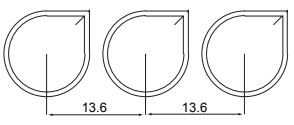

1N+1N+1N

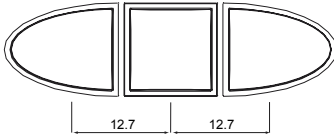

1V+1T+1V

SPACE REQUIREMENT - SWITCH/CAP

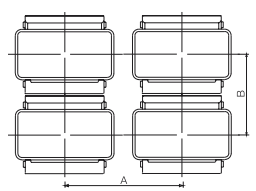

Switch spacing

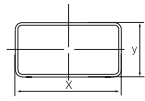

Cap dimensions

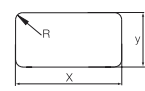

Panel cut-out

CAP SERIES	RECOMMENDED MIN.SWITCH SPACING AxB	NOMINAL CAP DIMENSION WxH	RECOMMENDED MIN. PANEL CUT-CUT
1D/1E/1F	12.7x11.3	Ø9.6	Ø10.0
1GA	12.7x11.3	Ø11.0	Ø11.4
1GC	15.3x15.3	Ø15.0	Ø15.4
1K/1KB/1KC	14.6x14.6	14.3x14.3	14.7x14.7
1N	13.6x11.3	Ø9.8/ □4.9	Ø10.2/□5.1
1P/ 1Q/1R	12.8x10.3	6.5x12.5	7.0x13.0, R max. 1.0
1S	12.7x10.3	Ø6.5	Ø7.0
1T	12.7x12.3	10.6x10.6	11.0x11.0
1U	12.7x12.3	Ø10.6	Ø11.0
1V	15.95x12.1	10.6x13.25	11.0x13.65
1WA	14.2x10.3	12.5x6.5	12.9x6.9
1WD	16.9x10.3	15.2x8.0	15.6x8.4
1X	12.7x10.3	9.4x7.4	9.8x7.9
1ZC	14.6x14.6	Ø14.3	Ø14.7

Multimec™ 3F

High performance tactile switches •
robust



LED COMPONENT SPECIFICATIONS

LED COMPONENT SPECIFICATIONS												
Color		B	G	Y	W	R	G/Y	R/G	R/Y	G	Y	R
Color Codes		06	20	40	65	80	2040	8020	8040	24	46	87
ABSOLUTE MAXIMUM RATINGS (Ta=25°C)												
Power	mW	120	120	60	110	100	100/60	100/100	75/75	60	60	60
Current forward	mA	30	30	20	30	30	30/20	30/30	30/30	25	25	25
Forward peak current	mA	150	90**	80**	100	90**	120/80	120/120	160/140	60	60	60
Voltage reverse	V	5	3	5	5	3	5	5	5	5	5	5
Operating temperature	°C	-40/+85	-55/+100		-40/+85	-55/+100	-55/+100	-55/+100	-40/+85	-40/+85	-40/+85	-40/+85
Storage temperature	°C	-40/+85	-55/+100		-40/+100	-55/+100	-55/+100	-55/+100	-40/+85	-40/+100	-40/+100	-40/+100
Soldering temperature	°C	260 for max 3 sec					260 for max 2 sec			260 for max 5 sec		
ELECTRICAL-OPTICAL CHARACTERISTICS (Ta=25°C)												
Voltage forward	Typ. V	3.3	2.1	2.1	3.0	2.0	2.1/2.1	2.0/2.1	2/2.1	2.0*	2.0	2.0***
	Max. V	4.0	2.6	2.6	4.0	2.6	2.6/2.4	2.6/2.6	2.5/2.5	2.4*	2.4	2.4***
Current reverse (VR=5V)	µA	Max. 50	100	100	100	100	100	100	2	10	10	10
Wave length	nm	460	569	588	NA	625	565	621/569	617/588	573	589	624
Spread	△nm	25	40	35	NA	40	30/35	40/30	45/35	20	NA	20
Spread angle	degree	30	60	60	25	60	80/60	200	60	100	40	40
Luminous Intensity	Min. mcd	900	5.6	1.7	715	2.5	3.7/2.5	2.2/2.2	6/4	10	630	400
	Typ. mcd	1600	12.6	5.6	max 2850	8.7	12.6/8.7	4.8/4.8	14/8	20	1250	800
Orientation	The longer pin is the anode, the shorter is the cathode. For bi-color LEDs the anode for the first color (ex. 8020) is the longer pin.											

*F=20mA, **1/10 duty cycles 0.1ms pulse width, ***/F=50mA, ****Luminous Flux mlm

Multimec™ 3F

High performance tactile switches •
robust



USAGE GUIDELINES

HOW TO GET THE BEST RESULTS WITH MEC SWITCHES ?

These guidelines are offered to users of MEC Switches as an aid to ensure successful and reliable switch operation. Please see the technical specifications for details on operating and storage temperatures and soldering guidelines to make sure you select the best switch for your application. When reflow soldering is taking place, MEC strongly recommend that the temperature profile is analyzed and compared with the temperature rating of the switch. It is also important to monitor the accumulated heat buildup from both the pre-heat zones and the solder zone.

Most standard accessories for multimec™ 3 series switches are made from ABS plastic with a maximum operating temperature of 65 °C. It is strongly recommended that accessories are mounted after soldering of the switch. If this is not possible care must be taken not to overheat the accessories during the soldering process. The 1S and 1GA/1GC caps are, however, made of high temperature materials and will meet the same temperature specifications as the switches. For accessories made from other plastic materials please see multimec™ 3 cap & bezel technical specifications.

LEDs have their own temperature specifications. When fitted in a 3F switch the LED will determine the max. operating temperature, i.e. 3FTH924 has an upper temperature limit of 85 °C!

MOUNTING AND DISMOUNTING

If switches are to be mounted in rows it is essential that the recommendations regarding spacing are followed. PC board thickness should be 1.4 ±0.2 mm and terminal hole diameter should be 0.9 mm.

All multimec™ caps and bezels are easily slid onto the switch modules and can be changed at a later time .

Care must be taken when inserting the 3FT switch and LED assembly into the PC board. Do not press direct on the LED. This will force the LED down into the actuator and risks to cause the switch contacts to remain in the closed position. To correct the fault, the LED must be raised slightly and centered in the actuator to assure unrestricted movement of the actuator.

A mounting tool is available for through hole multimec™ 3 series switches.

SOLDERING AND CLEANING MULTIMEC™ 3 SERIES

Multimec™ 3 series switches are fully sealed to IP67 specifications to prevent solder flux and aqueous based cleaning solutions from entering the switch and contaminating the contacts. The switches can be placed on the PC board with other components and reflow soldered. Multimec™ 3 series

offers a high level of sealing, however, with aqueous solvent solutions care must be taken to avoid the worst case situation with water jets, complete immersion into a liquid with a temperature below the board or surface tension reducing additives.

Recommended cleaning methods are demineralized water. Any surface tension reducing agents, such as soap, must not be used as they risk causing a potential leakage of the switch.

SOLDERING - THROUGH HOLE VERSIONS

Hand soldering: max. 350 °C for max. 3 sec

Wave soldering: heat built up in the switch during pre-heating and soldering must not exceed the maximum operating temperature of the switch. Peak temperature must not exceed 260 °C, and soldering time is max 10 sec. (IEC 60068-2-20 8)

SOLDERING - SURFACE MOUNT VERSIONS

For all methods - infrared, convection and vapor phase. The upper limit 240 °C/40 sec must be observed. The soldering temperature profile must have moderate temperature gradients. (JEDEC J-STD-020E)

ROHS COMPLIANCE

As of 1 July 2006 MEC has completed the conversion to RoHS compliance. For more info please see our homepage www.apem.com

TEMPERATURE LIMITS

Switch	160 °C
LEDs	80/85/100 °C
Accessories	65/85/160 °C

PACKAGING

Multimec™ 3 series switches are packed in rigid tubes of 50 pieces each.

A box contains 1.000 pcs.

The surface mount versions of multimec™ 3 series switches with a height up to 12.5 mm can also be delivered on tape/reel.

Each reel contains 250/500 pcs.

Right angle switches are packed in trays.
A tray contains 100 pcs.